

# XC6135 Series

ETR02041-004

## Ultra-Low Power (44nA) Voltage Detector with Separated Sense Pin

### ■ GENERAL DESCRIPTION

The XC6135 series is ultra-low power voltage detector with high accuracy detection, manufactured using CMOS process and laser trimming technologies.

Since the sense pin is separated from the power supply pin, it allows the IC to monitor the other power supply. The XC6135 can maintain the state of detection even when voltage of the monitored power supply drops to 0V. Sense Pin is also suited for detecting low voltages starting from 0.5V.

Ultra-small low height package USPQ-4B05 and standard packages SSOT-24 and SOT-25 which are ideally suited for small design of portable devices and high densely mounting applications.

UVLO circuit is implemented in order to suppress the floating of RESETB pin (undefined operation) when  $V_{IN}$  voltage is lower than the minimum operation voltage.

### ■ APPLICATIONS

- Energy Harvesting
- Wearable devices
- Smart meter
- Microprocessor logic reset circuitry
- System battery life and charge voltage monitors
- Power-on reset circuits
- Power failure Detection

### ■ FEATURES

Ultra-Low Power	: 53nA TYP.(@detection, $V_{IN}=1.1V$ ) : 44nA TYP.(@released, $V_{IN}=1.1V$ )
High Accuracy	: $\pm 10mV$ ( $0.5 \leq V_{DF} \leq 1.1V$ , $T_a=25^\circ C$ ) : $\pm 0.8\%$ ( $1.2 \leq V_{DF} \leq 3.0V$ , $T_a=25^\circ C$ ) : $\pm 1.0\%$ ( $3.1V \leq V_{DF} \leq 5.0V$ , $T_a=25^\circ C$ ) : $\pm 30mV$ ( $0.5 \leq V_{DF} \leq 1.1V$ , $T_a=-40^\circ C \sim 105^\circ C$ ) : $\pm 2.5\%$ ( $1.2 \leq V_{DF} \leq 3.0V$ , $T_a=-40^\circ C \sim 105^\circ C$ ) : $\pm 2.7\%$ ( $3.1V \leq V_{DF} \leq 5.0V$ , $T_a=-40^\circ C \sim 105^\circ C$ )
Temperature Characteristics	: $\pm 50ppm/^\circ C$ (TYP.)
Hysteresis width	: TYPE:A/C $V_{DF} \times 5.0\%$ (TYP.) TYPE:B/D 2mV ~ 28mV (TYP.)
Detect voltage range	: 0.5V ~ 5.0V (0.1Vstep)
Operating voltage range	: 1.1V ~ 6.0V
Output type	: CMOS Nch open drain
Output logic	: RESETB (Active Low) RESET (Active High)
Undefined operation Protection (CMOS Output only)	: Output pin Voltage 0.38V (MAX: $T_a=-40^\circ C \sim 105^\circ C$ ) @Power supply Input pin Voltage < Minimum operation Voltage
Packages	: USPQ-4B05, SSOT-24, SOT-25
Environment friendly	: EU RoHS Compliant, Pb Free

### ■ TYPICAL APPLICATION



(\*) Unused for the CMOS output products

### ■ TYPICAL PERFORMANCE CHARACTERISTICS



# XC6135 Series

## ■ BLOCK DIAGRAMS

(1) XC6135C Series A/B type (RESETB OUTPUT: CMOS output/Active Low)



\* Diodes inside the circuits are ESD protection diodes and parasitic diodes.

(2) XC6135C Series C/D type (RESETB OUTPUT: CMOS output/Active High)



\* Diodes inside the circuits are ESD protection diodes and parasitic diodes.

## ■ BLOCK DIAGRAMS

(3) XC6135N Series A/B type (RESETB OUTPUT: Nch open drain output /Active Low)

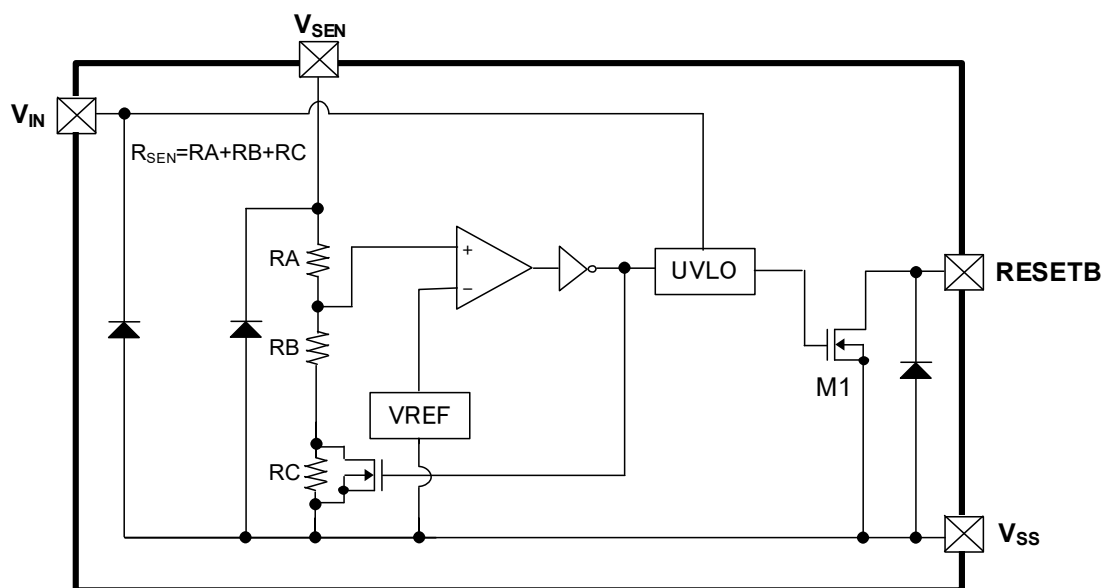

\* Diodes inside the circuits are ESD protection diodes and parasitic diodes.

(4) XC6135N Series C/D type (RESETB OUTPUT: Nch open drain output /Active High)



\* Diodes inside the circuits are ESD protection diodes and parasitic diodes.

# XC6135 Series

## PRODUCT CLASSIFICATION

### Ordering Information

XC6135①②③④⑤⑥-⑦<sup>(\*)</sup>

DESIGNATOR	ITEM	SYMBOL	DESCRIPTION
①	Output Configuration	C	CMOS output
		N	Nch open drain output
②③	Detect Voltage	05 ~ 50	e.g. 5.0V → ②=5, ③=0
④	Type	A	Refer to Selection Guide
		B	
		C	
		D	
⑤⑥-⑦ <sup>(*)</sup>	Package (Order Unit)	9R-G	USPQ-4B05 (5,000pcs/Reel)
		NR-G	SSOT-24 (3,000pcs/Reel)
		MR-G	SOT-25 (3,000pcs/Reel) <sup>(*)</sup>

<sup>(\*)</sup> The "-G" suffix denotes Halogen and Antimony free as well as being fully EU RoHS compliant.

<sup>(\*)</sup> SOT-25 uses Cu bonding wires.

### Selection Guide

TYPE	RESETB/RESET OUTPUT	HYSTERESIS
A	Active Low	$V_{DF} \times 5.0\%$ (TYP)
B	↑	2mV ~ 28mV (TYP) <sup>(*)</sup>
C	Active High	$V_{DF} \times 5.0\%$ (TYP)
D	↑	2mV ~ 28mV (TYP) <sup>(*)</sup>

<sup>(\*)</sup> Refer to SPEC TABLE.

## PIN CONFIGURATION

### Type: A/B

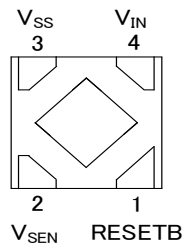

USPQ-4B05  
(BOTTOM VIEW)

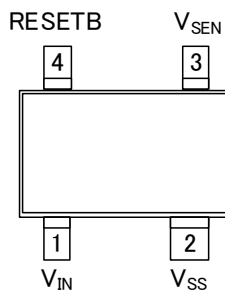

SSOT-24  
(TOP VIEW)



SOT-25  
(TOP VIEW)

### Type: C/D

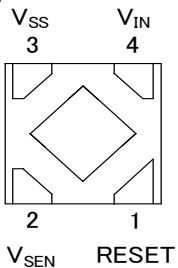

USPQ-4B05  
(BOTTOM VIEW)

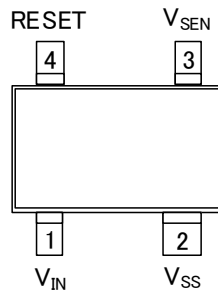

SSOT-24  
(TOP VIEW)

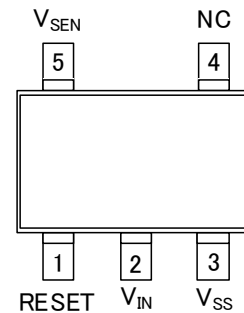

SOT-25  
(TOP VIEW)

\*The dissipation pad for the USPQ-4B05 package should be solder-plated in reference mount pattern and metal masking so as to enhance mounting strength and heat release. If the pad needs to be connected to other pins, it should be connected to  $V_{SS}$  (No. 3) pin.

## ■ PIN ASSIGNMENT

PIN NUMBER			PIN NAME	FUNCTION
USPQ-4B05	SSOT-24	SOT-25		
1	4	1	RESETB	Reset Output (Active Low) <sup>(*)1</sup>
			RESET	Reset Output (Active High) <sup>(*)2</sup>
2	3	5	V <sub>SEN</sub>	Voltage Sense
3	2	3	V <sub>SS</sub>	Ground
4	1	2	V <sub>IN</sub>	Power Input
-	-	4	NC	No Connection

<sup>(\*)1</sup> Type A,B (Refer to the ④ in Ordering Information table.)

<sup>(\*)2</sup> Type C,D (Refer to the ④ in Ordering Information table.)

## ■ ABSOLUTE MAXIMUM RATINGS

PARAMETER		SYMBOL		RATINGS	UNITS	
Input Voltage		V <sub>IN</sub>		-0.3 ~ 7.0	V	
V <sub>SEN</sub> Pin Voltage		V <sub>SEN</sub>		-0.3 ~ 7.0	V	
Output Voltage	XC6135C <sup>(*)2</sup>	V <sub>RESETB</sub>	V <sub>RESET</sub>	V <sub>SS</sub> - 0.3 ~ V <sub>IN</sub> + 0.3 or 7.0 <sup>(*)1</sup>	V	
	XC6135N <sup>(*)3</sup>			V <sub>SS</sub> - 0.3 ~ 7.0	V	
Output Current	XC6135C <sup>(*)2</sup>	I <sub>RBOUT</sub>	I <sub>ROUT</sub>	±50	mA	
	XC6135N <sup>(*)3</sup>			50		
Power Dissipation (Ta=25°C)	USPQ-4B05	Pd		100	mW	
				550 (40mm x 40mm Standard board) <sup>(*)4</sup>		
	SSOT-24			150		
				500 (40mm x 40mm Standard board) <sup>(*)4</sup>		
				680 (JESD51-7 board) <sup>(*)4</sup>		
	SOT-25			250		
600 (40mm x 40mm Standard board) <sup>(*)4</sup>						
				760b(JESD51-7 board) <sup>(*)4</sup>		
Operating Ambient Temperature		T <sub>opr</sub>		-40 ~ 105	°C	
Storage Temperature		T <sub>stg</sub>		-55 ~ 125	°C	

\* All voltages are described based on the V<sub>SS</sub>.

<sup>(\*)1</sup> The maximum value should be either V<sub>IN</sub>+0.3V or 7.0V in the lowest.

<sup>(\*)2</sup> CMOS output

<sup>(\*)3</sup> Nch open drain output

<sup>(\*)4</sup> The power dissipation figure shown is PCB mounted and is for reference only.

Please refer to PACKAGING INFORMATION for the mounting condition.

# XC6135 Series

## ELECTRICAL CHARACTERISTICS

PARAMETER	SYMBOL	CONDITIONS	Ta=25°C			-40°C ≤ Ta ≤ 105°C <sup>(4)</sup>			UNITS	CIRCUIT
			MIN.	TYP.	MAX.	MIN.	TYP.	MAX.		
Operating Voltage	V <sub>IN</sub>		1.1		6.0	1.1		6.0	V	①
MIN Voltage Holding the Detection <sup>(3)</sup>	V <sub>INL</sub>	V <sub>IN</sub> =V <sub>SEN</sub>	-	-	0.4	-	-	0.4	V	
Detect Voltage	V <sub>DF</sub>	V <sub>DF(T)</sub> <sup>(1)</sup> =0.5V~1.1V	V <sub>DF(T)</sub> -10mV	V <sub>DF(T)</sub>	V <sub>DF(T)</sub> +10mV	V <sub>DF(T)</sub> -30mV	V <sub>DF(T)</sub>	V <sub>DF(T)</sub> +30mV	V	
		V <sub>DF(T)</sub> <sup>(1)</sup> =1.2V~3.0V	V <sub>DF(T)</sub> ×0.992	V <sub>DF(T)</sub>	V <sub>DF(T)</sub> ×1.008	V <sub>DF(T)</sub> ×0.975	V <sub>DF(T)</sub>	V <sub>DF(T)</sub> ×1.025	V	
		V <sub>DF(T)</sub> <sup>(1)</sup> =3.1V~5.0V	V <sub>DF(T)</sub> ×0.990	V <sub>DF(T)</sub>	V <sub>DF(T)</sub> ×1.010	V <sub>DF(T)</sub> ×0.973	V <sub>DF(T)</sub>	V <sub>DF(T)</sub> ×1.027	V	
Temperature Characteristics	ΔV <sub>DF</sub> / (ΔT <sub>opr</sub> · V <sub>DF</sub> )	-40°C ≤ T <sub>opr</sub> ≤ 105°C	-	±50	-	-	±50	-	ppm/°C	
Hysteresis Width (TYPE: A/C)	V <sub>HYS</sub>		V <sub>DF</sub> ×0.032	V <sub>DF</sub> ×0.05	V <sub>DF</sub> ×0.068	V <sub>DF</sub> ×0.03	V <sub>DF</sub> ×0.05	V <sub>DF</sub> ×0.07	V	
Hysteresis Width (TYPE: B/D)			-	E-1 <sup>(2)</sup>		-	E-2 <sup>(2)</sup>		V	
Supply Current1 (TYPE:A/B)CMOS output	I <sub>ss1</sub>	V <sub>SEN</sub> =V <sub>DF</sub> ×0.9 V <sub>IN</sub> =1.1V						387	nA	②
Supply Current1 (TYPE:C/D)CMOS output								242		
Supply Current1 (TYPE:A/B/C/D) Nch open drain output								252		
Supply Current1 (TYPE:A/B)CMOS output							442			
Supply Current1 (TYPE:C/D)CMOS output			V <sub>SEN</sub> =V <sub>DF</sub> ×0.9 V <sub>IN</sub> =6.0V					252		
Supply Current1 (TYPE:A/B/C/D) Nch open drain output							262			
Supply Current2 (TYPE:A/B)CMOS output	I <sub>ss2</sub>	V <sub>SEN</sub> =V <sub>DF</sub> ×1.1 V <sub>IN</sub> =1.1V						230	nA	
Supply Current2 (TYPE:C/D)CMOS output								372		
Supply Current2 (TYPE:A/B/C/D) Nch open drain output								232		
Supply Current2 (TYPE:A/B)CMOS output							242			
Supply Current2 (TYPE:C/D)CMOS output			V <sub>SEN</sub> =V <sub>DF</sub> ×1.1 V <sub>IN</sub> =6.0V					422		
Supply Current2 (TYPE:A/B/C/D)Nch open drain output							242			
SENSE Resistance	R <sub>SEN</sub>	V <sub>IN</sub> =6.0V, V <sub>SEN</sub> =1.0V	E-3 <sup>(2)</sup>		-	E-4 <sup>(2)</sup>		MΩ	③	

<sup>(1)</sup> V<sub>DF(T)</sub>: Nominal detect voltage

<sup>(2)</sup> Refer to SPEC TABLE

<sup>(3)</sup> For XC6135C (CMOS output) only. V<sub>IN</sub> value where RESETB <0.05V or RESET > V<sub>IN</sub>.0.05V.

<sup>(4)</sup> The ambient temperature range (-40°C ≤ Ta ≤ 105°C) is a design value.

## ■ ELECTRICAL CHARACTERISTICS

PARAMETER	SYMBOL	CONDITIONS	Ta=25°C			-40°C ≤ Ta ≤ 105°C <sup>(9)</sup>			UNITS	CIRCUIT
			MIN.	TYP.	MAX.	MIN.	TYP.	MAX.		
Peak of Undefined Operation <sup>(5)</sup> (TYPE:A/B)	V <sub>UNO</sub>	V <sub>IN</sub> =V <sub>SEN</sub> , V <sub>IN</sub> <0.4V	-	0.1	0.38	-	0.1	0.38	V	④
UVLO Release Voltage	V <sub>UVLOR</sub>	V <sub>IN</sub> =0V→1.1V V <sub>SEN</sub> =V <sub>DF</sub> ×1.1	-	0.82	1.05	-	0.82	1.07	V	⑤
UVLO Detect Voltage	V <sub>UVLOD</sub>	V <sub>IN</sub> =1.1V→0V V <sub>SEN</sub> =V <sub>DF</sub> ×1.1	0.57	0.79	-	0.55	0.79	-		
UVLO Release Delay Time <sup>(6)</sup>	t <sub>UVLOR</sub>	V <sub>IN</sub> =0V→1.1V V <sub>SEN</sub> =V <sub>DF</sub> ×1.1	-	157	290	-	157	425	μs	⑥
Release Delay Time <sup>(7)</sup>	t <sub>DR0</sub>	V <sub>IN</sub> =6.0V V <sub>SEN</sub> =V <sub>DF</sub> ×0.9→ V <sub>DF</sub> ×1.1	-	44	200	-	44	224	μs	⑦
Detect Delay Time <sup>(8)</sup>	t <sub>DF0</sub>	V <sub>IN</sub> =6.0V V <sub>SEN</sub> =V <sub>DF</sub> ×1.1→ V <sub>DF</sub> ×0.9	-	40	170	-	40	184		

<sup>(5)</sup> For XC6135C (CMOS output) only.

<sup>(6)</sup> RESETB product: Time from when the V<sub>IN</sub> pin voltage reaches the UVLO release voltage until the reset output pin reaches V<sub>IN</sub>×90%.

RESET product: Time from when the V<sub>IN</sub> pin voltage reaches the UVLO release voltage until the reset output pin reaches V<sub>IN</sub>×10%.

<sup>(7)</sup> RESETB product: Time from when the V<sub>IN</sub> pin voltage reaches the release voltage until the reset output pin reaches 5.4V (V<sub>IN</sub>×90%).

RESET product: Time from when the V<sub>IN</sub> pin voltage reaches the release voltage until the reset output pin reaches 0.6V (V<sub>IN</sub>×10%)

Release voltage (V<sub>DR</sub>) = Detect voltage (V<sub>DF</sub>) + Hysteresis width (V<sub>HYS</sub>).

<sup>(8)</sup> RESETB product: Time from when the V<sub>IN</sub> pin voltage reaches the detect voltage until the reset output pin reaches 0.6V (V<sub>IN</sub>×10%).

RESET product: Time from when the V<sub>IN</sub> pin voltage reaches the detect voltage until the reset output pin reaches 5.4V (V<sub>IN</sub>×90%).

<sup>(9)</sup> The ambient temperature range (-40°C ≤ Ta ≤ 105°C) is a design Value.

## ELECTRICAL CHARACTERISTICS

PARAMETER	SYMBOL	CONDITIONS	Ta=25°C			-40°C ≤ Ta ≤ 105°C <sup>(12)</sup>			UNITS	CIRCUIT
			MIN.	TYP.	MAX.	MIN.	TYP.	MAX.		
RESETB Output Current	I <sub>RBOUN</sub>	V <sub>SEN</sub> =V <sub>DF</sub> ×0.9 Nch. V <sub>RESETB</sub> =0.3V							mA	⑧
		V <sub>IN</sub> =1.1V	0.3	1.4	-	0.2	1.4	-		
		V <sub>IN</sub> =2.0V	4.1	6.2	-	3.1	6.2	-		
		V <sub>IN</sub> =3.0V	8.1	10.8	-	4.3	10.8	-		
		V <sub>IN</sub> =4.0V	11.2	14.3	-	6.2	14.3	-		
		V <sub>IN</sub> =5.0V	13.7	17.1	-	7.3	17.1	-		
	V <sub>IN</sub> =6.0V	15.7	19.3	-	8.1	19.3	-			
	I <sub>RBOUP</sub> <sup>(10)</sup>	V <sub>SEN</sub> =V <sub>DF</sub> ×1.1 Pch. V <sub>RESETB</sub> =V <sub>IN</sub> -0.3V								
		V <sub>IN</sub> =1.0V	-	-0.7	-0.2	-	-0.7	-0.15		
		V <sub>IN</sub> =3.0V	-	-3.2	-1.4	-	-3.2	-1.3		
V <sub>IN</sub> =6.0V		-	-5.1	-2.9	-	-5.1	-2.6			
RESET Output Current	I <sub>ROUTN</sub>	V <sub>SEN</sub> =V <sub>DF</sub> ×1.1 Nch. V <sub>RESETB</sub> =0.3V								
		V <sub>IN</sub> =1.1V	0.3	1.4	-	0.2	1.4	-		
		V <sub>IN</sub> =2.0V	4.1	6.2	-	3.1	6.2	-		
		V <sub>IN</sub> =3.0V	8.1	10.8	-	4.3	10.8	-		
		V <sub>IN</sub> =4.0V	11.2	14.3	-	6.2	14.3	-		
		V <sub>IN</sub> =5.0V	13.7	17.1	-	7.3	17.1	-		
	V <sub>IN</sub> =6.0V	15.7	19.3	-	8.1	19.3	-			
	I <sub>ROUPT</sub> <sup>(10)</sup>	V <sub>SEN</sub> =V <sub>DF</sub> ×0.9 Pch. V <sub>RESET</sub> =V <sub>IN</sub> -0.3V								
		V <sub>IN</sub> =1.1V	-	-0.7	-0.2	-	-0.7	-0.15		
		V <sub>IN</sub> =3.0V <sup>(8)</sup>	-	-3.2	-1.4	-	-3.2	-1.3		
V <sub>IN</sub> =6.0V,		-	-5.1	-2.9	-	-5.1	-2.6			
RESETB Output Leakage Current	I <sub>LEAKN</sub> <sup>(11)</sup>	V <sub>IN</sub> =6.0V, V <sub>SEN</sub> =6.0V Nch. V <sub>RESETB</sub> =6.0V	-	0.01	0.1	-	0.01	0.3	μA	
	I <sub>LEAKP</sub>	V <sub>IN</sub> =6.0V, V <sub>SEN</sub> =0V Pch. V <sub>RESETB</sub> =0V	-	-0.01	-	-	-0.01	-		
RESET Output Leakage Current	I <sub>LEAKN</sub> <sup>(11)</sup>	V <sub>IN</sub> =6.0V, V <sub>SEN</sub> =0V Nch. V <sub>RESET</sub> =6.0V	-	0.01	0.1	-	0.01	0.3		
	I <sub>LEAKP</sub>	V <sub>IN</sub> =6.0V, V <sub>SEN</sub> =6.0V Pch. V <sub>RESET</sub> =0V	-	-0.01	-	-	-0.01	-		

<sup>(10)</sup> For XC6135C (CMOS output) only.

<sup>(11)</sup> Max. value is for XC6135N (Nch open drain).

<sup>(12)</sup> The ambient temperature range (-40°C ≤ Ta ≤ 105°C) is a design Value.



## ■ ELECTRICAL CHARACTERISTICS (SPEC TABLE)

Table of Characteristics by Voltage Setting

NOMINAL DETECT VOLTAGE(V)	E-1		E-2		E-3		E-4	
	Ta=25°C		-40°C ≤ Ta ≤ 105°C		Ta=25°C		-40°C ≤ Ta ≤ 105°C	
	Hysteresis Width (mV)				SENSE Resistance (MΩ)			
V <sub>DF(T)</sub>	TYP.	MAX.	TYP.	MAX.	MIN	TYP.	MIN	TYP.
0.5	1	2.0	1	2.2	4.0	23	3.1	23
0.6	1	2.4	1	2.7	3.6	27	3.0	27
0.7	1	2.8	1	3.1	2.8	31	2.7	31
0.8	1	3.2	1	3.5	2.5	35	2.4	35
0.9	1	3.6	1	4.0	2.9	38	2.8	38
1.0	2	4.0	2	4.4	4.0	39	3.9	39
1.1	2	4.4	2	4.9	14	39	11	39
1.2	2	4.8	2	5.3	15	40	12	40
1.3	2	5.2	2	5.7	16	42	13	42
1.4	2	5.6	2	6.2	17	41	13	41
1.5	2	6.0	2	6.6	16	41	13	41
1.6	2	6.4	2	7.1	16	41	13	41
1.7	3	6.8	3	7.5	16	40	13	40
1.8	3	7.2	3	8.0	16	39	12	39
1.9	3	7.9	3	8.7	16	39	12	39
2.0	3	8.6	3	9.5	16	38	12	38
2.1	4	9.4	4	10	16	37	12	37
2.2	4	10	4	11	16	37	12	37
2.3	5	11	5	12	16	36	12	36
2.4	5	12	5	13	15	36	12	36
2.5	6	13	6	14	15	36	12	36
2.6	6	14	6	15	15	35	12	35
2.7	7	15	7	16	15	35	12	35
2.8	8	16	8	17	15	35	12	35
2.9	8	17	8	18	15	35	12	35
3.0	9	18	9	19	15	34	11	34
3.1	9	19	9	20	15	34	11	34
3.2	10	20	10	21	15	34	11	34
3.3	11	21	11	23	15	34	11	34
3.4	12	22	12	24	15	33	11	33
3.5	12	23	12	25	15	33	11	33
3.6	13	25	13	26	15	33	11	33
3.7	14	26	14	28	15	33	11	33
3.8	15	27	15	29	15	33	11	33
3.9	16	29	16	30	15	33	11	33
4.0	17	30	17	32	15	33	11	33
4.1	18	32	18	33	15	32	11	32
4.2	19	33	19	35	15	32	11	32
4.3	20	35	20	36	15	32	11	32

## ELECTRICAL CHARACTERISTICS (SPEC TABLE)

Table of Characteristics by Voltage Setting

NOMINAL DETECT VOLTAGE(V)	E-1		E-2		E-3		E-4	
	Ta=25°C		-40°C ≤ Ta ≤ 105°C		Ta=25°C		-40°C ≤ Ta ≤ 105°C	
	Hysteresis Width (mV)				SENSE Resistance (MΩ)			
V <sub>DF(T)</sub>	TYP.	MAX.	TYP.	MAX.	MIN	TYP.	MIN	TYP.
4.4	21	36	21	38	15	32	11	32
4.5	22	38	22	40	15	32	11	32
4.6	23	39	23	41	15	32	11	32
4.7	24	41	24	43	15	32	11	32
4.8	25	43	25	45	15	32	11	32
4.9	26	44	26	46	14	32	11	32
5.0	28	46	28	48	14	32	11	32

## ■ TEST CIRCUITS

CIRCUIT①



CIRCUIT②



CIRCUIT③



CIRCUIT④



\*"RESETB" is A/B type, and "RESET" is C/D type.

## TEST CIRCUITS

CIRCUIT⑤



CIRCUIT⑥



CIRCUIT⑦

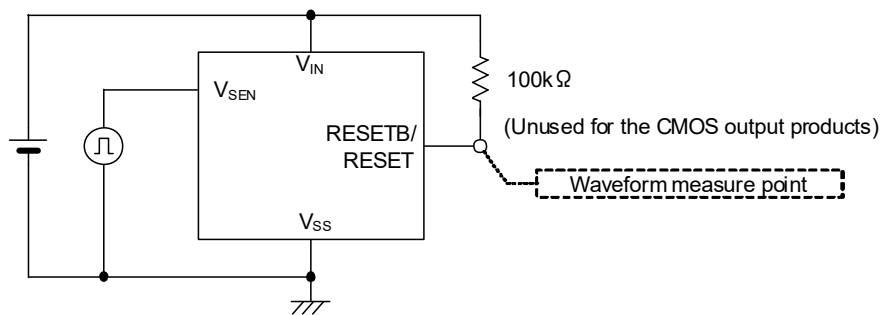

CIRCUIT⑧



\*"RESETB" is A/B type, and "RESET" is C/D type.

## OPERATIONAL DESCRIPTION ( $V_{IN}$ and $V_{SEN}$ are separated)



Fig. 1: Typical block diagram (CMOS output/Active Low product)

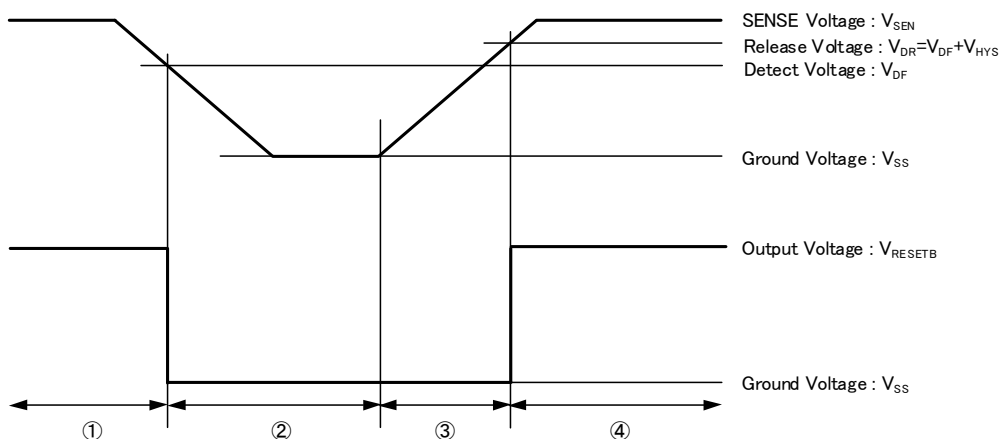

Fig. 2: Timing chart of Fig. 1 ( $V_{DD}=6.0V$ )

The circuit operation in the above representative circuit example will be explained using the timing chart.

- (1) Assume that the  $V_{SEN}$  pin voltage in the initial state is higher than the release voltage ( $V_{DR}$ ), and  $V_{SEN}$  gradually decreases. In a state where a voltage higher than the detection voltage ( $V_{DF}$ ) is applied to the  $V_{SEN}$  pin voltage, the input voltage ( $V_{IN}$ ) is output to the RESETB pin (released state).  
\* In the case of N-ch open drain output products, the RESETB pin goes into a high impedance state. When the output is pulled up, the pull-up voltage is output to the RESETB pin.
  - (2) When the  $V_{SEN}$  pin voltage drops below the detection voltage ( $V_{DF}$ ), the ground potential ( $V_{SS}$ ) is output to the RESETB pin (detection state).
  - (3) The RESETB pin keeps the ground potential until the  $V_{SEN}$  pin voltage goes up to release voltage ( $V_{DR}$ ).
  - (4) When the  $V_{SEN}$  pin voltage becomes equal to or higher than the release voltage ( $V_{DR}$ ), the input voltage ( $V_{IN}$ ) is output to the RESETB pin.  
\* In the case of N-ch open drain output products, the RESETB pin goes into a high-impedance state in the same way as in 1), and if the output is pulled up, the pull-up voltage is output to the RESETB pin.
- \* The difference between the release voltage ( $V_{DR}$ ) and the detect voltage ( $V_{DF}$ ) is the hysteresis width ( $V_{HYS}$ ).

Note: In the above explanation, the operation time of the circuit is omitted for simplicity of explanation. For Active High products, please reverse the output logic of RESETB pin voltage.

## OPERATIONAL DESCRIPTION ( $V_{IN}$ and $V_{SEN}$ are connected)



Fig. 3: Typical block diagram (CMOS output/Active Low product)



Fig. 4: Timing chart of Fig. 3

The circuit operation in the above representative circuit example will be explained using the timing chart.

(1) As for the voltage detectors, when the input voltage is under the minimum operation voltage, an unstable voltage will be output to the RESETB pin. However, the XC6136C series (CMOS output product) incorporates an under-voltage lockout (UVLO) circuit which can minimize the floating of the RESETB terminal caused by a voltage lower than the minimum operation voltage at  $V_{IN}$ . Please refer to the specifications of the undefined operation on the P.7 of the electrical characteristics.

\* Pull-up voltage may be output to the RESETB terminal when the output terminal is pulled up with an N-ch open drain output product.

(2) The RESETB pin keeps the ground potential (release state) until the  $V_{SEN}$  pin voltage goes up to the release voltage ( $V_{DR}$ ), even exceeding the UVLO release voltage.

(3) When the  $V_{SEN}$  pin voltage becomes equal to or higher than the release voltage ( $V_{DR}$ ), the input voltage ( $V_{IN}$ ) is output to the RESETB pin.

\* Pull-up voltage may be output to the RESETB terminal when the output terminal is pulled up with an N-ch open drain output product.

(4) When the input voltage ( $V_{IN}$ ) drops below the detection voltage ( $V_{DF}$ ), the ground potential ( $V_{SS}$ ) is output to the RESETB pin (detection state).\* N-ch open drain output products are also the same.

(5) In the case that the input voltage is under the minimum operation voltage, same as ①, with the built-in UVLO circuit, the floating of the RESETB terminal can be minimized.

\* The difference between the release voltage ( $V_{DR}$ ) and the detect voltage ( $V_{DF}$ ) is the hysteresis width ( $V_{HYS}$ ).

Note: In the above explanation, the operation time of the circuit is omitted for simplicity of explanation.

For Active High products, please reverse the output logic of RESETB pin voltage.

## ■ NOTES ON USE

- (1) Please use this IC within the stated maximum ratings. For temporary, transitional voltage drop or voltage rising phenomenon, the IC is liable to malfunction should the ratings be exceeded.
- (2) The power input pin voltage may fall due to the flow through current during IC operation and the resistance component between the power supply and the power input pin.  
In the case of CMOS output, a drop in the power input pin voltage may occur in the same way due to the output current. When this happens, if the power input pin voltage drops below the minimum operating voltage, a malfunction may occur.
- (3) Note that large, sharp changes of the power input pin voltage may lead to malfunction.
- (4) Since the power supply noise may cause malfunction, please fully evaluate with an actual system. As necessary, please take measures such as inserting a capacitor between  $V_{IN}$  and  $V_{SS}$ .
- (5) When an N-ch open drain output is used, the  $V_{RESETB}$  voltage at detection and release is determined by the pull-up resistance connected to the output pin. Refer to the following when selecting the resistance value.

At detection:

$$V_{RESETB} = V_{pull} / (1 + R_{pull} / R_{ON})$$

$V_{pull}$  : Voltage after pull-up

$R_{ON}^{(*)}$  : ON resistance of N-ch driver M1 (calculated from  $V_{RESETB}/I_{RBOUIN}$  based on electrical characteristics)

Example: When  $V_{IN}=2.0V^{(**)}$ ,  $R_{ON} = 0.3V / (4.1 \times 10^{-3} A) \cong 73.2\Omega$  (MAX.)

If it is desired to make  $V_{RESETB}$  at detection 0.1V or less when  $V_{pull}$  is 3.0V,

$$R_{pull} = \{ (V_{pull} / V_{RESETB}) - 1 \} \times R_{ON} = \{ (3V / 0.1V) - 1 \} \times 73.2\Omega \cong 2.1k\Omega$$

Therefore, to make the output voltage at detection 0.1V or less under the above conditions, the pull-up resistance must be 2.1k $\Omega$  or higher.

(\*) Note that  $R_{ON}$  becomes larger as  $V_{IN}$  becomes smaller.

(\*\*) For  $V_{IN}$  in the calculation, use the lowest value of the input voltage range you will use.

At release:

$$V_{RESETB} = V_{pull} / (1 + R_{pull} / R_{off})$$

$V_{pull}$  : Voltage after pull-up

$R_{off}$  : Resistance when N-ch driver M1 is OFF (calculated from  $V_{RESETB}/I_{LEAKN}$  based on electrical characteristics)

Example: When  $V_{pull}$  is 6.0V,  $R_{off} = 6V / (0.1 \times 10^{-6} A) = 60M\Omega$  (MIN.).

If it is desired to make  $V_{RESETB}$  5.99V or higher,

$$R_{pull} = \{ (V_{pull} / V_{RESETB}) - 1 \} \times R_{off} = \{ (6V / 5.99V) - 1 \} \times 60 \times 10^6\Omega \cong 100k\Omega$$

Therefore, to make the output voltage at release 5.99V or higher under the above conditions, the pull-up resistance must be 100k $\Omega$  or less. The above  $V_{RESETB}$  voltage is an example calculation of Active Low products.

To calculate the  $V_{RESET}$  voltage (Active High product), calculate by inverting the logic at detection and release.

- (6) As for the products of detect voltage 0.5V~1.0V, in the case that the  $V_{SEN}$  voltage is over than 1.0V, a current will flow at the inner diode which will cause  $R_{SEN}$ (SENSE Resistance) drops lower than the standard value, consequently ,the current flowing at  $V_{SEN}$  increases. (Shown as following chart).

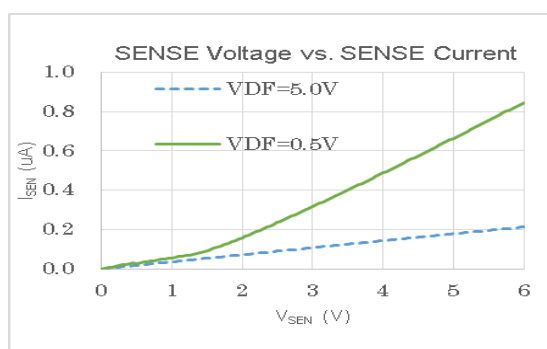

Fig.5 :  $I_{SEN}$  Current Comparison between  $V_{DF}=0.5V$  and  $V_{DF}=5.0V$

- (7) Torex places an importance on improving our products and their reliability. We request that users incorporate fail-safe designs and post-aging protection treatment when using Torex products in their systems.

# XC6135 Series

## TYPICAL PERFORMANCE CHARACTERISTICS

(1) Detect, Release Voltage vs. Ambient Temperature

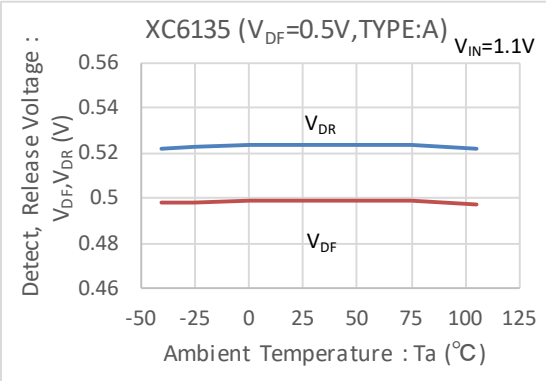

(2) Output Voltage vs. Sense Voltage

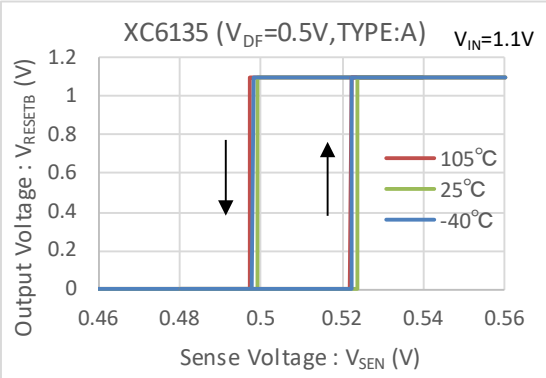

(3) Hysteresis Width vs. Ambient Temperature

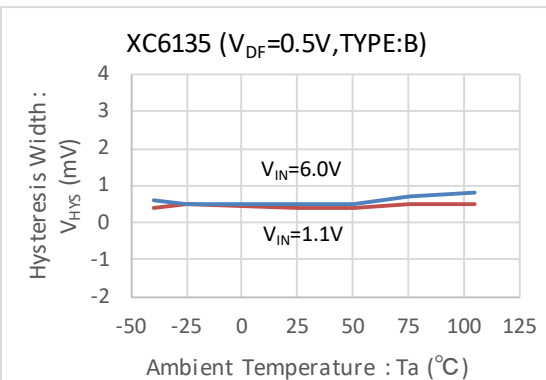
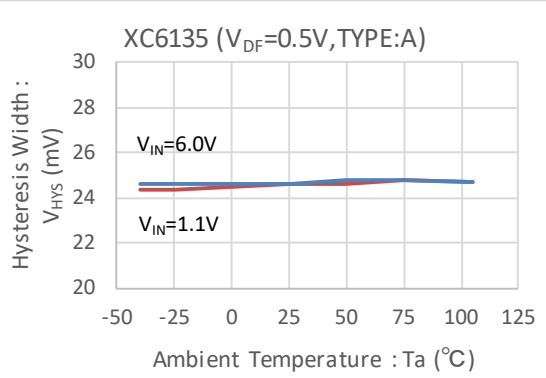



## ■ TYPICAL PERFORMANCE CHARACTERISTICS (Continued)

(4) Supply Current vs. Ambient Temperature



(5) Supply Current vs. Input Voltage



(6) Sense Resistance vs. Ambient Temperature



(7) Output Voltage vs. Input Voltage ( $V_{IN} < \text{Operating Voltage}$ )



# XC6135 Series

## TYPICAL PERFORMANCE CHARACTERISTICS (Continued)

(8)UVLO Detect, Release Voltage vs. Ambient Temperature



(9)UVLO Detect, Release Voltage vs. Input Voltage



(10)UVLO Release Delay Time vs. Ambient Temperature



(11)Release, Detect Delay Time vs. Ambient Temperature



(12)RESETB Output Current vs. Ambient Temperature



(13)RESETB Output Leakage Current vs. Ambient Temperature



## ■ PACKAGING INFORMATION

For the latest package information go to, [www.torexsemi.com/technical-support/packages](http://www.torexsemi.com/technical-support/packages)

PACKAGE	OUTLIN / LAND PATTERN	THERMAL CHARACTERISTICS	
SSOT-24	<a href="#">SSOT-24 PKG</a>	Standard Board	<a href="#">SSOT-24 Power Dissipation</a>
		JESD51-7 Board	
SOT-25	<a href="#">SOT-25 PKG</a>	Standard Board	<a href="#">SOT-25 Power Dissipation</a>
		JESD51-7 Board	
USPQ-4B05	<a href="#">USPQ-4B05 PKG</a>	Standard Board	<a href="#">USPQ-4B05 Power Dissipation</a>

# XC6135 Series

## MARKING RULE

USPQ-4B05 (with underline mark ①)



SSOT-24 (with underline mark①)



USPQ-4B05 (with overline mark①)



SSOT-24 (with overline mark①)



USPQ-4B05 (with underline mark②)

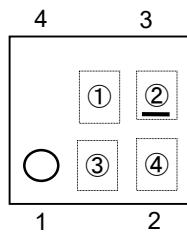

SSOT-24 (with underline mark②)



① represents products series

MARK	Registration order	PRODUCT SERIES
<u>X</u> (with underline)	1	XC6135*****-G
<u>1</u> (with overline)	2	
<u>3</u> (with overline)	3	
<u>5</u> (with overline)	4	
A	5	
B	6	
C	7	

\*Mark ① is a common symbol and Mark ② is assigned a sequential number.

(The sequential numbers of Mark② are numbered statina from "0".)

② represents internal sequential number

MARK①	MARK ①Line	MARK ②Line
<u>X</u>	with underline	-
<u>1</u>	with overline	-
<u>3</u>	with overline	-
<u>5</u>	with overline	-
A	-	with underline
B	-	with underline
C	-	with underline

sequential number 0~9, A~Z repeated.(G, I, J, O, Q, W excluded)

③,④ represents production lot number

01~09, 0A~0Z, 11~9Z, A1~A9, AA~A9, AA~Z9 repeated.

(G, I, J, O, Q, W excluded)

## ■ MARKING RULE

SOT-25 (under dot)

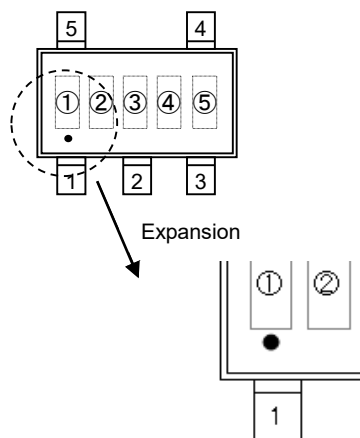

① represents products series

MARK	PRODUCT SERIES
X	XC6135*****-G

※Mark ① gets a serial number with a common symbol.

※Under dot

②③ represents internal sequential number

sequential number 01~09, 10~99, A0~A9, B0~B9...Z0~Z9, AA~AZ, BA~BZ...ZA~ZZ repeated.  
(G, I, J, O, Q, W excluded)

④⑤ represents production lot number

01~09, 0A~0Z, 11...9Z, A1~A9, AA...Z9, ZA~ZZ repeated  
(G, I, J, O, Q, W excluded)

\* No character inversion used.