

XC6136 Series

ETR02042-004

Ultra-Low Power (88nA) Voltage Detector

■ GENERAL DESCRIPTION

The XC6136 series is ultra-low power voltage detector with high accuracy detection, manufactured using CMOS process and laser trimming technologies.

The device is available in both CMOS and N-channel open drain output configurations. Also detect logic is available in both RESETB (Active Low) and RESET (Active High).

Ultra-small low height package USPQ-4B05 and standard packages SSOT-24 and SOT-25 which are ideally suited for small design of portable devices and high density mounting applications.

UVLO circuit is implemented in order to suppress the floating of RESETB pin (undefined operation) when V_{IN} voltage is lower than the minimum operating voltage.

■ APPLICATIONS

- Energy Harvesting
- Wearable devices
- Smart meter
- Microprocessor logic reset circuitry
- System battery life and charge voltage monitors
- Power-on reset circuits
- Power failure Detection

■ FEATURES

Ultra-Low Power	: 91nA TYP.(@detect, $V_{DF}=1.2V$, $V_{IN}=1.1V$) : 88nA TYP.(@release, $V_{DF}=1.2V$, $V_{IN}=1.32V$)
High Accuracy	: $\pm 0.8\%$ ($V_{DF} \leq 3.0V$, $T_a=25^\circ C$) : $\pm 1.0\%$ ($3.1V \leq V_{DF}$, $T_a=25^\circ C$) : $\pm 2.5\%$ ($V_{DF} \leq 3.0V$, $T_a=-40^\circ C \sim 105^\circ C$) : $\pm 2.7\%$ ($3.1V \leq V_{DF}$, $T_a=-40^\circ C \sim 105^\circ C$)
Temperature Characteristics	: $\pm 50ppm/^\circ C$ (TYP.)
Hysteresis width	: TYPE:A/C $V_{DF} \times 5.0\%$ (TYP.) : TYPE:B/D 2mV ~ 28mV (TYP.)
Detect voltage range	: 1.2V ~ 5.0V (0.1Vstep)
Operating voltage range	: 1.1V ~ 6.0V
Output type	: CMOS : Nch open drain
Output logic	: RESETB (Active Low) : RESET (Active High)
Undefined operation Protection (CMOS Output only)	: Output pin Voltage 0.38V (MAX: $T_a=-40^\circ C \sim 105^\circ C$) @Power supply Input pin Voltage < operating voltage (MIN.)
Packages	: USPQ-4B05, SSOT-24, SOT-25
Environment friendly	: EU RoHS Compliant, Pb Free

■ TYPICAL APPLICATION CIRCUIT



(*) Unused for the CMOS output products

■ TYPICAL PERFORMANCE CHARACTERISTICS



■ BLOCK DIAGRAMS

(1) XC6136C Series A/B type (RESETB OUTPUT:CMOS output/Active Low)

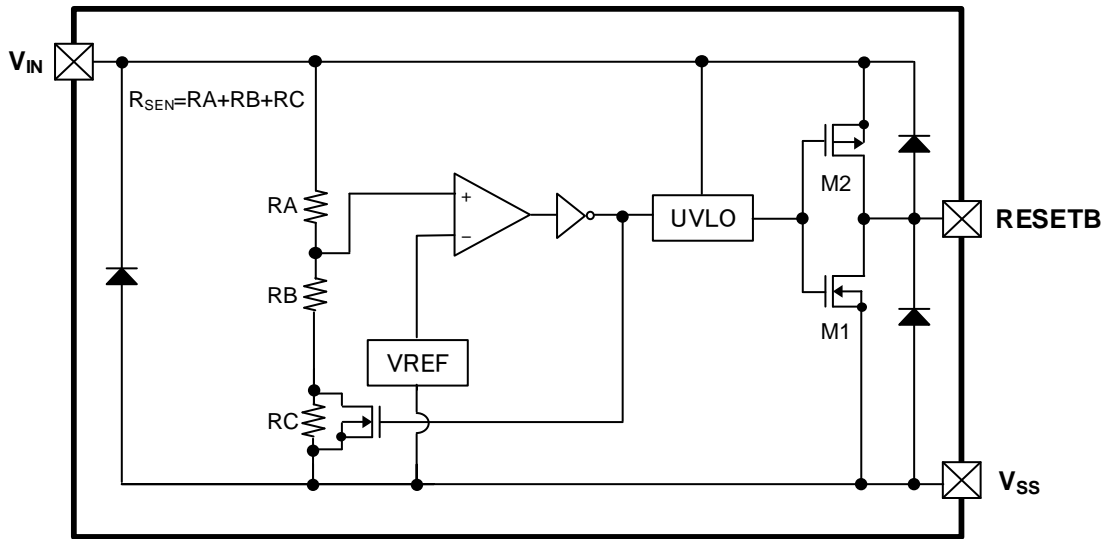

* Diodes inside the circuits are ESD protection diodes and parasitic diodes.

(2) XC6136C Series C/D type (RESET OUTPUT:CMOS output /Active High)



* Diodes inside the circuits are ESD protection diodes and parasitic diodes.

■ BLOCK DIAGRAMS

(3) XC6136N Series A/B type (RESETB OUTPUT: Nch open drain output /Active Low)



* Diodes inside the circuits are ESD protection diodes and parasitic diodes

(4) XC6136N Series C/D type (RESET OUTPUT: Nch open drain output /Active High)



* Diodes inside the circuits are ESD protection diodes and parasitic diodes

PRODUCT CLASSIFICATION

Ordering Information

XC6136①②③④⑤⑥-⑦^(*)

DESIGNATOR	ITEM	SYMBOL	DESCRIPTION
①	Output Configuration	C	CMOS output
		N	Nch open drain output
②③	Detect Voltage	12 ~ 50	e.g. 1.2V → ②=1, ③=2
④	Type	A	Refer to Selection Guide
		B	
		C	
		D	
⑤⑥-⑦ ^(*)	PKG	9R-G	USPQ-4B05 (5,000pcs/Reel)
		NR-G	SSOT-24 (3,000pcs/Reel)
		MR-G	SOT-25 (3,000pcs/Reel) ⁽²⁾

^(*) The “-G” suffix denotes Halogen and Antimony free as well as being fully EU RoHS compliant.

⁽²⁾ SOT-25 uses Cu bonding wires.

Selection Guide

TYPE	RESETB/RESET OUTPUT	HYSTERESIS
A	Active Low	$V_{DF} \times 5.0\%$ (TYP)
B	↑	2mV ~ 28mV (TYP) ^(*)
C	Active High	$V_{DF} \times 5.0\%$ (TYP)
D	↑	2mV ~ 28mV (TYP) ^(*)

^(*) Refer to SPEC TABLE.

PIN CONFIGURATION

Type : A/B



Type : C/D

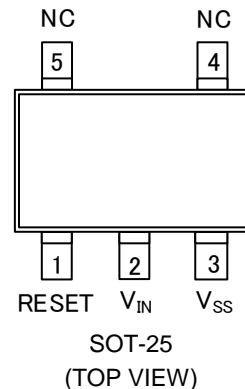

*The dissipation pad for the USPQ-4B05 package should be solder-plated in reference mount pattern and metal masking so as to enhance mounting strength and heat release. If the pad needs to be connected to other pins, it should be connected to V_{SS} (No. 3) pin.

■ PIN ASSIGNMENT

PIN NUMBER			PIN NAME	FUNCTION
USPQ-4B05	SSOT-24	SOT-25		
1	3	1	RESETB	Reset Output (Active Low) ⁽¹⁾
			RESET	Reset Output (Active High) ⁽²⁾
2	1	4, 5	NC	No Connection
3	2	3	V _{SS}	Ground
4	4	2	V _{IN}	Power Input

⁽¹⁾ Type A,B (Refer to the ④ in Ordering Information table.)

⁽²⁾ Type C,D (Refer to the ④ in Ordering Information table.)

■ ABSOLUTE MAXIMUM RATINGS

PARAMETER		SYMBOL		RATINGS	UNITS	
Input Voltage		V _{IN}		-0.3 ~ 7.0	V	
Output Voltage	XC6136C ⁽²⁾	V _{RESETB}	V _{RESET}	V _{SS} - 0.3 ~ V _{IN} + 0.3 or 7.0 ⁽¹⁾	V	
	XC6136N ⁽³⁾			V _{SS} - 0.3 ~ 7.0	V	
Output Current	XC6136C ⁽²⁾	I _{RBOUT}	I _{ROUT}	±50	mA	
	XC6136N ⁽³⁾			50		
Power Dissipation (Ta=25°C)	USPQ-4B05	Pd		100	mW	
				550 (40mm x 40mm Standard board) ⁽⁴⁾		
				150		
	SSOT-24			500 (40mm x 40mm Standard board) ⁽⁴⁾		
				680 (JESD51-7 board) ⁽⁴⁾		
	SOT-25			250		
				600 (40mm x 40mm Standard board) ⁽⁴⁾		
760 (JESD51-7 board) ⁽⁴⁾						
Operating Ambient Temperature		Topr		-40 ~ 105	°C	
Storage Temperature		Tstg		-55 ~ 125	°C	

* All voltages are described based on the V_{SS}.

⁽¹⁾ The maximum value should be either V_{IN}+0.3V or 7.0V in the lowest.

⁽²⁾ CMOS output

⁽³⁾ Nch open drain output

⁽⁴⁾ The power dissipation figure shown is PCB mounted and is for reference only.

Please refer to PACKAGING INFORMATION for the mounting condition.

ELECTRICAL CHARACTERISTICS

PARAMETER	SYMBOL	CONDITIONS	Ta=25°C			-40°C ≤ Ta ≤ 105°C ⁽⁵⁾			UNITS	CIRCUIT	
			MIN.	TYP.	MAX.	MIN.	TYP.	MAX.			
Operating Voltage	V _{IN}		1.1		6.0	1.1		6.0	V	①	
MIN Voltage Holding the Detection ⁽³⁾	V _{INL}	V _{IN} =V _{SEN}	-	-	0.4	-	-	0.4	V		
Detect Voltage	V _{DF}	V _{DF(T)} ⁽¹⁾ =1.2V~3.0V	V _{DF(T)} x0.992	V _{DF(T)}	V _{DF(T)} x1.008	V _{DF(T)} x0.975	V _{DF(T)}	V _{DF(T)} x1.025	V		
		V _{DF(T)} ⁽¹⁾ =3.1V~5.0V	V _{DF(T)} x0.990	V _{DF(T)}	V _{DF(T)} x1.010	V _{DF(T)} x0.973	V _{DF(T)}	V _{DF(T)} x1.027	V		
Temperature Characteristics	ΔV _{DF} / (ΔT _{opr} · V _{DF})	-40°C ≤ T _{opr} ≤ 105°C	-	±50	-	-	±50	-	ppm/°C		
Hysteresis Width (TYPE: A/C)	V _{HYS}		V _{DF} x0.032	V _{DF} x0.05	V _{DF} x0.068	V _{DF} x0.03	V _{DF} x0.05	V _{DF} x0.07	V		
Hysteresis Width (TYPE: B/D)			-	E-1 ⁽²⁾	-	E-2 ⁽²⁾	V				
Supply Current1 (TYPE:A/B) CMOS output	I _{ss1}	V _{IN} =V _{DF} x0.9	-	E-3 ⁽²⁾	-	-	-	-	E-4 ⁽²⁾	nA	②
Supply Current1 (TYPE:C/D) CMOS output									E-5 ⁽²⁾		
Supply Current1 (TYPE:A/B/C/D) Nch open drain output									E-6 ⁽²⁾		
Supply Current2 (TYPE:A/B) CMOS output	I _{ss2}	V _{IN} =V _{DF} x1.1	-	E-7 ⁽²⁾	-	-	-	-	E-8 ⁽²⁾		
Supply Current2 (TYPE:C/D) CMOS output									E-9 ⁽²⁾		
Supply Current2 (TYPE:A/B/C/D) Nch open drain output									E-10 ⁽²⁾		
Peak of Undefined Operation ⁽⁴⁾ (TYPE:A/B)	V _{UNO}	V _{IN} <0.4V	-	0.1	0.38	-	0.1	0.38	V	③	
UVLO Release Voltage	V _{UVLOR}	V _{IN} =0V→1.1V	-	0.82	-	-	0.82	-	V	-	
UVLO Detect Voltage	V _{UVLOD}	V _{IN} =1.1V→0V	-	0.79	-	-	0.79	-	V	-	
UVLO Release Delay Time	t _{UVLOR}	V _{IN} = 0V→1.1V	-	157	-	-	157	-	μs	-	

⁽¹⁾ V_{DF(T)}: Nominal detect voltage

⁽²⁾ Refer to SPEC TABLE(P.8,9).

⁽³⁾ For XC6136C (CMOS output) only. V_{IN} value where RESETB <0.05V or RESET > V_{IN}.0.05V.

⁽⁴⁾ XC6136C(CMOS output)only.

⁽⁵⁾ The ambient temperature range (-40°C ≤ Ta ≤ 105°C) is a design value.

ELECTRICAL CHARACTERISTICS

PARAMETER	SYMBOL	CONDITIONS	Ta=25°C			-40°C ≤ Ta ≤ 105°C ⁽¹⁷⁾			UNITS	CIRCUIT
			MIN.	TYP.	MAX.	MIN.	TYP.	MAX.		
Release Delay Time ⁽⁶⁾	t _{DR0}	V _{IN} = V _{DF} × 0.9 → V _{DF} × 1.1	-	44	200	-	44	224	μs	④
Detect Delay Time ⁽⁷⁾	t _{DF0}	V _{IN} = V _{DF} × 1.1 → V _{DF} × 0.9	-	40	170	-	40	184		
RESETB Output Current	I _{RBOUTN}	Nch. V _{RESETB} = 0.3V							mA	⑤
		V _{IN} = 1.1V	0.3	1.4	-	0.2	1.4	-		
		V _{IN} = 2.0V ⁽⁸⁾	4.1	6.2	-	3.1	6.2	-		
		V _{IN} = 3.0V ⁽⁹⁾	8.1	10.8	-	4.3	10.8	-		
	V _{IN} = 4.0V ⁽¹⁰⁾	11.2	14.3	-	6.2	14.3	-			
	I _{RBOUTP} ⁽¹¹⁾	Pch. V _{RESETB} = V _{IN} - 0.3V								
		V _{IN} = 3.0V ⁽¹²⁾	-	-3.2	-1.4	-	-3.2	-1.3		
		V _{IN} = 6.0V	-	-5.1	-2.9	-	-5.1	-2.6		
RESET Output Current	I _{ROUTN}	Nch. V _{RESET} = 0.3V							mA	⑤
		V _{IN} = 2.0V ⁽¹³⁾	4.1	6.2	-	3.1	6.2	-		
		V _{IN} = 3.0V ⁽¹²⁾	8.1	10.8	-	4.3	10.8	-		
		V _{IN} = 4.0V ⁽¹⁴⁾	11.2	14.3	-	6.2	14.3	-		
		V _{IN} = 5.0V ⁽¹⁵⁾	13.7	17.1	-	7.3	17.1	-		
	V _{IN} = 6.0V	15.7	19.3	-	8.1	19.3	-			
	I _{ROUTP} ⁽¹⁶⁾	Pch. V _{RESET} = V _{IN} - 0.3V								
		V _{IN} = 1.1V	-	-0.7	-0.2	-	-0.7	-0.15		
		V _{IN} = 3.0V ⁽⁹⁾	-	-3.2	-1.4	-	-3.2	-1.3		
RESETB Output Leakage Current	I _{LEAKN} ⁽¹⁶⁾	V _{IN} = 6.0V, Nch. V _{RESETB} = 6.0V	-	0.01	0.1	-	0.01	0.3	μA	⑤
	I _{LEAKP}	V _{IN} = 1.1V, Pch. V _{RESETB} = 0V	-	-0.01	-	-	-0.01	-		
RESET Output Leakage Current	I _{LEAKN} ⁽¹⁶⁾	V _{IN} = 1.1V, Nch. V _{RESET} = 6.0V	-	0.01	0.1	-	0.01	0.3		
	I _{LEAKP}	V _{IN} = 6.0V, Pch. V _{RESET} = 0V	-	-0.01	-	-	-0.01	-		

⁽⁶⁾ RESETB product: Time from when the V_{IN} pin voltage reaches the release voltage until the reset output pin reaches V_{IN} × 90%.

RESET product: Time from when the V_{IN} pin voltage reaches the release voltage until the reset output pin reaches V_{IN} × 10%

Release voltage (V_{DR}) = Detect voltage (V_{DF}) + Hysteresis width (V_{HYS}).

⁽⁷⁾ RESETB product: Time from when the V_{IN} pin voltage reaches the detect voltage until the reset output pin reaches V_{IN} × 10%.

RESET product: Time from when the V_{IN} pin voltage reaches the detect voltage until the reset output pin reaches V_{IN} × 90%.

⁽⁸⁾ For V_{DF(T)} ≥ 2.1V only

⁽⁹⁾ For V_{DF(T)} ≥ 3.1V only.

⁽¹⁰⁾ For V_{DF(T)} ≥ 4.1V only.

⁽¹¹⁾ For XC6136C (CMOS output) only.

⁽¹²⁾ For V_{DF(T)} ≤ 2.9V only.

⁽¹³⁾ For V_{DF(T)} ≤ 1.9V only.

⁽¹⁴⁾ For V_{DF(T)} ≤ 3.8V only.

⁽¹⁵⁾ For V_{DF(T)} ≤ 4.8V only.

⁽¹⁶⁾ Max. value is for XC6136N (Nch open drain).

⁽¹⁷⁾ The ambient temperature range (-40°C ≤ Ta ≤ 105°C) is a design Value.

ELECTRICAL CHARACTERISTICS (SPEC TABLE)

Table of Characteristics by Voltage Setting

NOMINAL DETECT VOLTAGE(V)	E-1		E-2		E-3		E-4		E-5		E-6	
	Ta=25°C		-40°C ≤ Ta ≤ 105°C		Ta=25°C		-40°C ≤ Ta ≤ 105°C					
	Hysteresis Width (mV)				Supply Current1 (nA)							
V _{DF(T)}	TYP.	MAX.	TYP.	MAX.	TYP.	MAX.	TYP.	MAX.	TYP.	MAX.	TYP.	MAX.
1.2	2	4.8	2	5.3	91	213	91	431	91	325	91	338
1.3	2	5.2	2	5.7	94	218	94	437	94	331	94	345
1.4	2	5.6	2	6.2	98	224	98	444	98	338	98	351
1.5	2	6.0	2	6.6	101	229	101	451	101	344	101	358
1.6	2	6.4	2	7.1	104	235	104	457	104	351	104	364
1.7	3	6.8	3	7.5	108	240	108	464	108	357	108	371
1.8	3	7.2	3	8.0	111	245	111	471	111	363	111	377
1.9	3	7.9	3	8.7	114	251	114	478	114	370	114	384
2.0	3	8.6	3	9.5	117	256	117	484	117	376	117	390
2.1	4	9.4	4	10	121	262	121	491	121	383	121	397
2.2	4	10	4	11	124	267	124	498	124	389	124	403
2.3	5	11	5	12	127	272	127	504	127	395	127	410
2.4	5	12	5	13	131	278	131	511	131	402	131	416
2.5	6	13	6	14	134	283	134	518	134	408	134	423
2.6	6	14	6	15	137	289	137	524	137	415	137	429
2.7	7	15	7	16	140	294	140	531	140	421	140	436
2.8	8	16	8	17	144	299	144	538	144	427	144	442
2.9	8	17	8	18	147	305	147	545	147	434	147	449
3.0	9	18	9	19	150	310	150	551	150	440	150	455
3.1	9	19	9	20	154	316	154	558	154	447	154	462
3.2	10	20	10	21	157	321	157	565	157	453	157	468
3.3	11	21	11	23	160	326	160	571	160	459	160	475
3.4	12	22	12	24	163	332	163	578	163	466	163	481
3.5	12	23	12	25	167	337	167	585	167	472	167	488
3.6	13	25	13	26	170	343	170	591	170	479	170	494
3.7	14	26	14	28	173	348	173	598	173	485	173	501
3.8	15	27	15	29	177	353	177	605	177	491	177	507
3.9	16	29	16	30	180	359	180	612	180	498	180	514
4.0	17	30	17	32	183	364	183	618	183	504	183	520
4.1	18	32	18	33	186	370	186	625	186	511	186	527
4.2	19	33	19	35	190	375	190	632	190	517	190	533
4.3	20	35	20	36	193	380	193	638	193	523	193	540
4.4	21	36	21	38	196	386	196	645	196	530	196	546
4.5	22	38	22	40	200	391	200	652	200	536	200	553
4.6	23	39	23	41	203	397	203	658	203	543	203	559
4.7	24	41	24	43	206	402	206	665	206	549	206	566
4.8	25	43	25	45	210	407	210	672	210	555	210	572
4.9	26	44	26	46	213	413	213	679	213	562	213	579
5.0	28	46	28	48	216	418	216	685	216	568	216	585

■ ELECTRICAL CHARACTERISTICS (SPEC TABLE)

Table of Characteristics by Voltage Setting

NOMINAL DETECT VOLTAGE(V)	E-7		E-8		E-9		E-10	
	Ta=25°C		-40°C ≤ Ta ≤ 105°C					
	Supply Current2 (nA)							
V _{DF(T)}	TYP.	MAX.	TYP.	MAX.	TYP.	MAX.	TYP.	MAX.
1.2	88	204	88	325	88	474	88	327
1.3	92	211	92	334	92	482	92	336
1.4	95	217	95	342	95	490	95	344
1.5	99	224	99	350	99	498	99	352
1.6	103	230	103	358	103	506	103	360
1.7	107	237	107	366	107	515	107	368
1.8	111	243	111	374	111	523	111	376
1.9	115	250	115	382	115	531	115	384
2.0	119	256	119	390	119	539	119	392
2.1	123	263	123	398	123	547	123	400
2.2	127	269	127	406	127	556	127	408
2.3	131	276	131	415	131	564	131	417
2.4	135	282	135	423	135	572	135	425
2.5	139	289	139	431	139	580	139	433
2.6	143	295	143	439	143	588	143	441
2.7	147	302	147	447	147	597	147	449
2.8	151	308	151	455	151	605	151	457
2.9	155	315	155	463	155	613	155	465
3.0	158	321	158	471	158	621	158	473
3.1	162	328	162	479	162	629	162	481
3.2	166	334	166	487	166	638	166	489
3.3	170	341	170	496	170	646	170	498
3.4	174	347	174	504	174	654	174	506
3.5	178	354	178	512	178	662	178	514
3.6	182	360	182	520	182	670	182	522
3.7	186	367	186	528	186	679	186	530
3.8	190	373	190	536	190	687	190	538
3.9	194	380	194	544	194	695	194	546
4.0	198	386	198	552	198	703	198	554
4.1	202	393	202	560	202	711	202	562
4.2	206	399	206	568	206	720	206	570
4.3	210	406	210	577	210	728	210	579
4.4	214	412	214	585	214	736	214	587
4.5	218	419	218	593	218	744	218	595
4.6	222	425	222	601	222	752	222	603
4.7	225	432	225	609	225	761	225	611
4.8	229	438	229	617	229	769	229	619
4.9	233	445	233	625	233	777	233	627
5.0	237	451	237	633	237	785	237	635

TEST CIRCUITS

CIRCUIT①

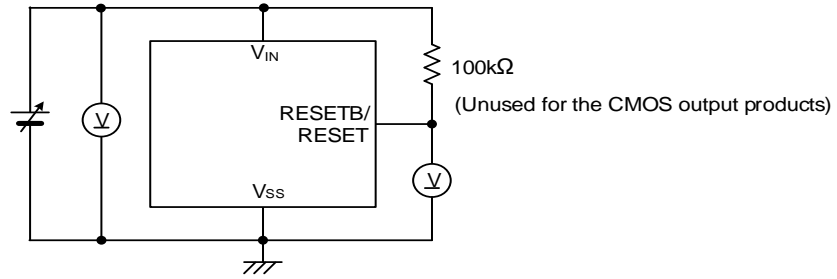

CIRCUIT②



CIRCUIT③



CIRCUIT④



CIRCUIT⑤



**RESETB" is A/B type, and "RESET" is C/D type.

■ OPERATIONAL DESCRIPTION



Fig. 1: Typical block diagram (CMOS output/Active Low product)



Fig. 2: Timing chart of Fig. 1

The circuit operation in the above representative circuit example will be explained using the timing chart.

- (1) Assume that the input voltage (V_{IN}) in the initial state is higher than the release voltage (V_{DR}), and V_{IN} gradually decreases. In a state where a voltage higher than the detection voltage (V_{DF}) is applied to the input voltage (V_{IN}), the input voltage (V_{IN}) is output to the RESETB pin (released state).
 - * In the case of N-ch open drain output products, the RESETB pin goes into a high impedance state. When the output is pulled up, the pull-up voltage is output to the RESETB pin.
- (2) When the input voltage (V_{IN}) drops below the detection voltage (V_{DF}), the ground potential (V_{SS}) is output to the RESETB pin (detection state).
 - * N-ch open drain output products are also the same.
- (3) If the input voltage (V_{IN}) further decreases and becomes lower than the minimum operating voltage (1.1V), the output becomes undefined.

However, the XC6136C series (CMOS output product) has an under-voltage lockout (UVLO) circuit to prevent undefined operation due to a decrease in V_{IN} .

Therefore, the floating of the RESETB terminal caused by less than the minimum operating voltage is minimized.

 - * Pull-up voltage may be output to the RESETB terminal when the output terminal is pulled up with an N-ch open drain output product.
- (4) The RESETB pin holds the ground potential (V_{SS}) until the input voltage (V_{IN}) rises above the minimum operating voltage (1.1V) and reaches the release voltage (V_{DR}).
- (5) When the input voltage (V_{IN}) becomes equal to or higher than the release voltage (V_{DR}), the input voltage (V_{IN}) is output to the RESETB pin.
 - * In the case of N-ch open drain output products, the RESETB pin goes into a high-impedance state in the same way as in 1), and if the output is pulled up, the pull-up voltage is output to the RESETB pin.
- (6) The difference between the release voltage (V_{DR}) and the detect voltage (V_{DF}) is the hysteresis width (V_{HYS}).

Note: In the above explanation, the operation time of the circuit is omitted for simplicity of explanation. In addition, above explanation is the operation using Active Low product.

For Active High products, please reverse the output logic of RESETB pin voltage.

NOTES ON USE

- (1) Please use this IC within the stated maximum ratings. For temporary, transitional voltage drop or voltage rising phenomenon, the IC is liable to malfunction should the ratings be exceeded.
- (2) The power input pin voltage may fall due to the flow through current during IC operation and the resistance component between the power supply and the power input pin.
In the case of CMOS output, a drop in the power input pin voltage may occur in the same way due to the output current. When this happens, if the power input pin voltage drops below the minimum operating voltage, a malfunction may occur.
- (3) Note that large, sharp changes of the power input pin voltage may lead to malfunction.
- (4) Since the power supply noise may cause malfunction, please fully evaluate with an actual system. As necessary, please take measures such as inserting a capacitor between V_{IN} and V_{SS} .
- (5) When an N-ch open drain output is used, the V_{RESETB} voltage at detection and release is determined by the pull-up resistance connected to the output pin. Refer to the following when selecting the resistance value.

At detection:

$$V_{RESETB} = V_{pull} / (1 + R_{pull} / R_{ON})$$

V_{pull} : Voltage after pull-up

$R_{ON}^{(*)}$: ON resistance of N-ch driver M1 (calculated from V_{RESETB}/I_{RBOUN} based on electrical characteristics)

Example: When $V_{IN}=2.0V^{(2)}$, $R_{ON} = 0.3V / (4.1 \times 10^{-3} A) \cong 73.2\Omega$ (MAX.)

If it is desired to make V_{RESETB} at detection 0.1V or less when V_{pull} is 3.0V,

$$R_{pull} = \{ (V_{pull} / V_{RESETB}) - 1 \} \times R_{ON} = \{ (3V / 0.1V) - 1 \} \times 73.2\Omega \cong 2.1k\Omega$$

Therefore, to make the output voltage at detection 0.1V or less under the above conditions, the pull-up resistance must be 2.1k Ω or higher.

^(*) Note that R_{ON} becomes larger as V_{IN} becomes smaller.

⁽²⁾ For V_{IN} in the calculation, use the lowest value of the input voltage range you will use.

At release:

$$V_{RESETB} = V_{pull} / (1 + R_{pull} / R_{off})$$

V_{pull} : Voltage after pull-up

R_{off} : Resistance when N-ch driver M1 is OFF (calculated from V_{RESETB}/I_{LEAKN} based on electrical characteristics)

Example: When V_{pull} is 6.0V, $R_{off} = 6V / (0.1 \times 10^{-6} A) = 60M\Omega$ (MIN.).

If it is desired to make V_{RESETB} 5.99V or higher,

$$R_{pull} = \{ (V_{pull} / V_{RESETB}) - 1 \} \times R_{off} = \{ (6V / 5.99V) - 1 \} \times 60 \times 10^6\Omega \cong 100k\Omega$$

Therefore, to make the output voltage at release 5.99V or higher under the above conditions, the pull-up resistance must be 100k Ω or less.

The above V_{RESETB} voltage is an example calculation of Active Low products.

To calculate the V_{RESET} voltage (Active High product), calculate by inverting the logic at detection and release.

- (6) Torex places an importance on improving our products and their reliability. We request that users incorporate fail-safe designs and post-aging protection treatment when using Torex products in their systems.

TYPICAL PERFORMANCE CHARACTERISTICS

(1) Detect, Release Voltage vs. Ambient Temperature



(2) Output Voltage vs. Input Voltage



(3) Hysteresis Width vs. Ambient Temperature



(4) Supply Current vs. Ambient Temperature

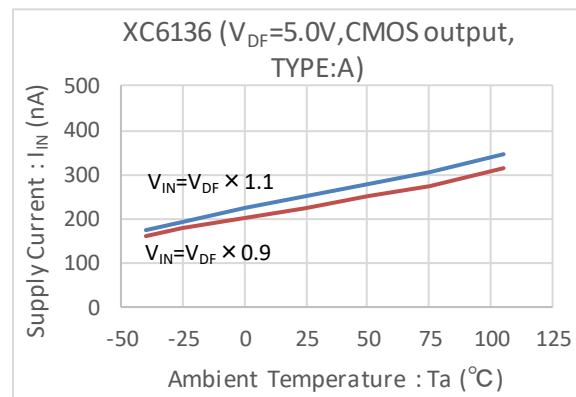
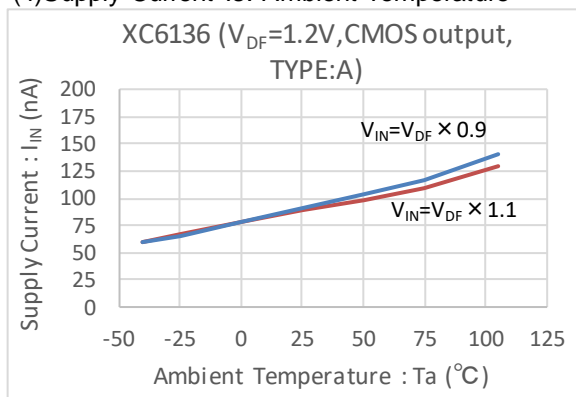

(5) Supply Current vs. Input Voltage

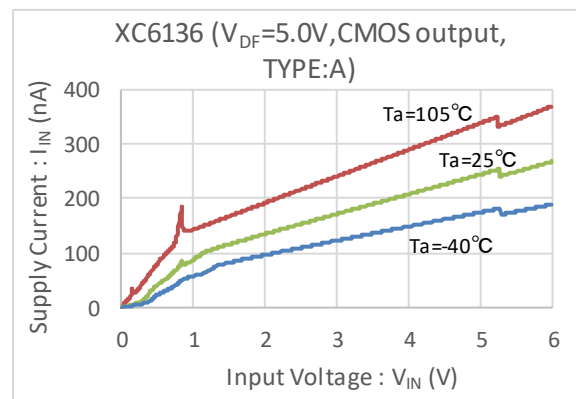
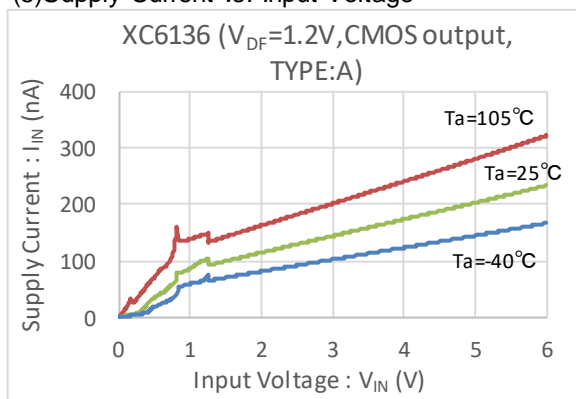

XC6136 Series

TYPICAL PERFORMANCE CHARACTERISTICS (Continued)

(6) Output Voltage vs. Input Voltage ($V_{IN} < \text{Operating Voltage}$)



(7) Release, Detect Delay Time vs. Ambient Temperature



(8) RESETB Output Current vs. Ambient Temperature



(9) RESETB Output Leakage Current vs. Ambient Temperature



■ PACKAGING INFORMATION

For the latest package information go to, www.torexsemi.com/technical-support/packages

PACKAGE	OUTLIN / LAND PATTERN	THERMAL CHARACTERISTICS	
SSOT-24	SSOT-24 PKG	Standard Board	SSOT-24 Power Dissipation
		JESD51-7 Board	
SOT-25	SOT-25 PKG	Standard Board	SOT-25 Power Dissipation
		JESD51-7 Board	
USPQ-4B05	USPQ-4B05 PKG	Standard Board	USPQ-4B05 Power Dissipation

MARKING RULE

USPQ-4B05 (with underline mark ①)

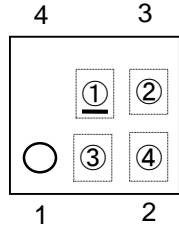

SSOT-24 (with underline mark) ①

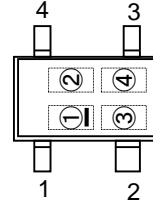

USPQ-4B05 (with overline mark) ①

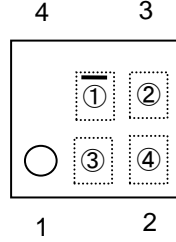

SSOT-24 (with overline mark) ①

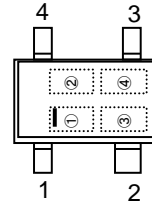

USPQ-4B05 (with underline mark ②)



SSOT-24 (with underline mark ②)

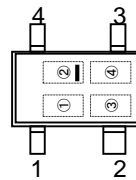

① represents products series

MARK	Registration order	PRODUCT SERIES
<u>X</u> (with underline)	1	XC6136*****-G
<u>1</u> (with overline)	2	
<u>3</u> (with overline)	3	
<u>5</u> (with overline)	4	
<u>A</u>	5	
<u>B</u>	6	
<u>C</u>	7	

*Mark ① is a common symbol and Mark ② is assigned a sequential number.
(The sequential numbers of Mark ② are numbered stating from "0".)

② represents internal sequential number

MARK①	MARK ①Line	MARK ②Line
<u>X</u>	with underline	-
<u>1</u>	with overline	-
<u>3</u>	with overline	-
<u>5</u>	with overline	-
A	-	with underline
B	-	with underline
C	-	with underline

sequential number 0~9, A~Z repeated.(G, I, J, O, Q, W excluded)

③,④ represents production lot number

01~09, 0A~0Z, 11~9Z, A1~A9, AA~A9, AA~Z9 repeated.

(G, I, J, O, Q, W excluded)

MARKING RULE

SOT-25 (under dot)



① represents products series

MARK	PRODUCT SERIES
X	XC6136*****-G

※Mark ① gets a serial number with a common symbol.

※Under dot

②③ represents internal sequential number

01~09, 10~99, A0~A9, B0~B9...Z0~Z9, AA~AZ, BA~BZ...ZA~ZZ repeated.

(G, I, J, O, Q, W excluded)

④⑤ represents production lot number

01~09, 0A~0Z, 11...9Z, A1~A9, AA...Z9, ZA~ZZ repeated

(G, I, J, O, Q, W excluded)

* No character inversion used.