

Positive Voltage Regulators

■ GENERAL DESCRIPTION

The XC6201 series are highly precise, low power consumption, positive voltage regulators manufactured using CMOS and laser trimming technologies.

The series provides large currents with a significantly small dropout voltage.

The XC6201 consists of a current limiter circuit, a driver transistor, a precision reference voltage and an error amplifier. Output voltage is selectable in 0.1V steps between 1.3V ~ 6.0V.

SOT-25, SOT-89, USP-6B and TO-92 packages are available.

■ APPLICATIONS

- Mobile Phones
- Cordless phones, wireless communication equipment
- Cameras, video recorders
- Portable games
- Portable AV equipment
- Reference voltage
- Battery powered equipment

■ FEATURES

Maximum Output Current	: 250mA (TYP.)
Dropout Voltage	: 0.16V @ 100mA : 0.40V @ 200mA
Maximum Operating Voltage	: 10V
Output Voltage Range	: 1.3V ~ 6.0V (0.1V increments)
Fixed Voltage Accuracy	: $\pm 1\%$ ($V_{OUT(T)} \geq 2.0V$) : $\pm 2\%$
Low Power Consumption	: 2.0 μ A (TYP.)
Operating Ambient Temperature	: -40°C ~ 85°C
Packages	: SOT-25, SOT-89 TO-92 USP-6B
Environmentally Friendly	: EU RoHS Compliant, Pb Free
Tantalum or Ceramic Capacitor compatible	

■ TYPICAL APPLICATION CIRCUIT



■ TYPICAL PERFORMANCE CHARACTERISTICS

- Supply Current vs. Input Voltage

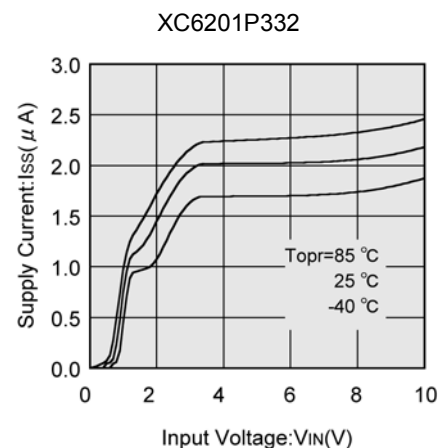

PIN CONFIGURATION

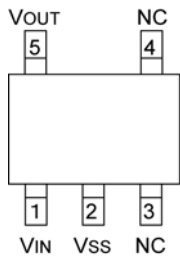

SOT-25
(TOP VIEW)

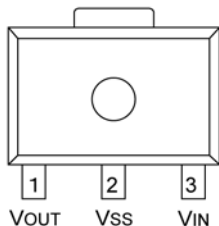

SOT-89
(TOP VIEW)

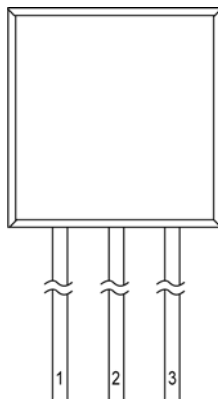

TO-92 (T Tvpde)
(SIDE VIEW)

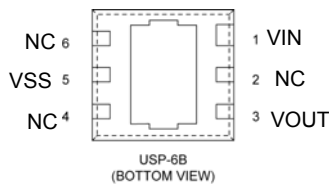

*The dissipation pad for the USP-6B package should be solder-plated in recommended mount pattern and metal masking so as to enhance mounting strength and heat release. If the pad needs to be connected to other pins, it should be connected to the VSS (No.5) pin.

PIN ASSIGNMENT

PIN NUMBER			PIN NAME	FUNCTION
SOT-25	SOT-89/TO-92 (T)	USP-6B		
5	1	3	VOUT	Output
2	2	5	VSS	Ground
1	3	1	VIN	Power Input
3, 4	—	2,4,6	NC	No Connection

PRODUCT CLASSIFICATION

Ordering Information

XC6201P ③④⑤⑥⑦⑧^(*)
 ↑ ↑
 ① ②

DESIGNATOR	ITEM	SYMBOL	DESCRIPTION
①	Product Number	01	-
②	Type of Regulator	P	3-pin regulator
③④	Output Voltage	13~60	e.g. 30:3.0V 50:5.0V
⑤	Output Voltage Accuracy	1	±1%
		2	±2%
⑥⑦⑧	Packages (Order Unit)	MR	SOT-25 (3,000/Reel)
		MR-G	SOT-25 (3,000/Reel)
		PR	SOT-89 (1,000/Reel)
		PR-G	SOT-89 (1,000/Reel)
		TH	TO-92 Taping Type: Paper type (2,000/Tape)
		TH-G	TO-92 Taping Type: Paper type (2,000/Tape)
		TB	TO-92 Taping Type: Bag (500/Bag)
		TB-G	TO-92 Taping Type: Bag (500/Bag)
		DR	USP-6B (3,000/Reel)
		DR-G	USP-6B (3,000/Reel)

(*) The "-G" suffix denotes Halogen and Antimony free as well as being fully RoHS compliant.

* ±1% accuracy can be set at $V_{OUT(T)} \geq 2.0V$.

■ BLOCK DIAGRAM

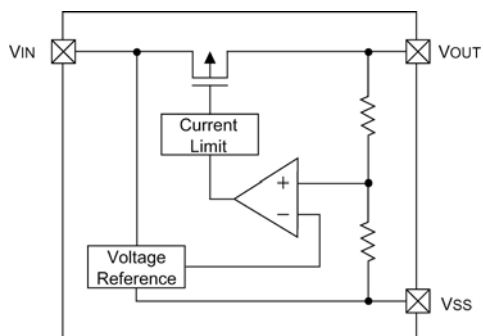

■ ABSOLUTE MAXIMUM RATINGS

Ta = 25°C

PARAMETER		SYMBOL	RATINGS	UNITS
Input Voltage		V _{IN}	12.0	V
Output Current		I _{OUT}	500	mA
Output Voltage		V _{OUT}	V _{SS} -0.3~V _{IN} +0.3	V
Power Dissipation	SOT-25	P _d	250	mW
	SOT-89		500	
	TO-92		300	
	USP-6B		120	
Operating Temperature		T _{opr}	-40~+85	°C
Storage Temperature		T _{stg}	-55~+125	°C

■ ELECTRICAL CHARACTERISTICS

XC6201P132 V_{OUT(T)}=1.3V (*1)

Ta=25°C

PARAMETER	SYMBOL	CONDITIONS	MIN.	TYP.	MAX.	UNITS	CIRCUIT
Output Voltage	V _{OUT(E)} (*2)	V _{IN} =2.3V I _{OUT} =10mA	1.274	1.300	1.326	V	②
Maximum Output Current	I _{OUTmax}	V _{IN} =2.3V V _{OUT(E)} ≥1.17V	60	-	-	mA	②
Load Regulation	ΔV _{OUT}	V _{IN} =2.3V 1mA≤I _{OUT} ≤30mA	-	10	30	mV	②
Dropout Voltage (*3)	V _{dif1}	I _{OUT} =30mA	-	200	600	mV	②
	V _{dif2}	I _{OUT} =60mA	-	500	810		
Supply Current	I _{SS}	V _{IN} =2.3V	-	2.0	5.0	μA	①
Line Regulation	$\frac{\Delta V_{OUT}}{\Delta V_{IN} \cdot \Delta V_{OUT}}$	I _{OUT} =10mA 2.3V≤V _{IN} ≤10.0V	-	0.2	0.3	%/V	②
Input Voltage	V _{IN}		1.8	-	10	V	-
Output Voltage Temperature Characteristics	$\frac{\Delta V_{OUT}}{\Delta T_{opr} \cdot \Delta V_{OUT}}$	I _{OUT} =40mA -40°C≤T _{opr} ≤85°C	-	±100	-	ppm/°C	②

ELECTRICAL CHARACTERISTICS (Continued)

XC6201P182 $V_{OUT(T)}=1.8V$ (*1) Ta=25°C

PARAMETER	SYMBOL	CONDITIONS	MIN.	TYP.	MAX.	UNITS	CIRCUIT
Output Voltage	$V_{OUT(E)}$ (*2)	$V_{IN}=2.8V$ $I_{OUT}=40mA$	1.764	1.800	1.836	V	②
Maximum Output Current	I_{OUTmax}	$V_{IN}=2.8V$ $V_{OUT(E)} \geq 1.62V$	80	-	-	mA	②
Load Regulation	ΔV_{OUT}	$V_{IN}=2.8V$ $1mA \leq I_{OUT} \leq 40mA$	-	10	30	mV	②
Dropout Voltage (*3)	Vdif1	$I_{OUT}=40mA$	-	200	370	mV	②
	Vdif2	$I_{OUT}=80mA$	-	450	710		
Supply Current	I_{SS}	$V_{IN}=2.8V$	-	2.0	5.0	μA	①
Line Regulation	$\frac{\Delta V_{OUT}}{\Delta V_{IN} \cdot \Delta V_{OUT}}$	$I_{OUT}=40mA$ $2.8V \leq V_{IN} \leq 10.0V$	-	0.2	0.3	%/V	②
Input Voltage	V_{IN}		1.8	-	10	V	-
Output Voltage Temperature Characteristics	$\frac{\Delta V_{OUT}}{\Delta T_{opr} \cdot \Delta V_{OUT}}$	$I_{OUT}=40mA$ $-40^\circ C \leq T_{opr} \leq 85^\circ C$	-	± 100	-	ppm/°C	②

XC6201P272 $V_{OUT(T)}=2.7V$ (*1) Ta=25°C

PARAMETER	SYMBOL	CONDITIONS	MIN.	TYP.	MAX.	UNITS	CIRCUIT
Output Voltage	$V_{OUT(E)}$ (*2)	$V_{IN}=3.7V$ $I_{OUT}=40mA$	2.646	2.700	2.754	V	②
Maximum Output Current	I_{OUTmax}	$V_{IN}=3.7V$ $V_{OUT(E)} \geq 2.43V$	100	-	-	mA	②
Load Regulation	ΔV_{OUT}	$V_{IN}=3.7V$ $1mA \leq I_{OUT} \leq 60mA$	-	15	40	mV	②
Dropout Voltage (*3)	Vdif1	$I_{OUT}=60mA$	-	200	370	mV	②
	Vdif2	$I_{OUT}=120mA$	-	450	710		
Supply Current	I_{SS}	$V_{IN}=3.7V$	-	2.0	5.0	μA	①
Line Regulation	$\frac{\Delta V_{OUT}}{\Delta V_{IN} \cdot \Delta V_{OUT}}$	$I_{OUT}=40mA$ $3.7V \leq V_{IN} \leq 10.0V$	-	0.2	0.3	%/V	②
Input Voltage	V_{IN}		1.8	-	10	V	-
Output Voltage Temperature Characteristics	$\frac{\Delta V_{OUT}}{\Delta T_{opr} \cdot \Delta V_{OUT}}$	$I_{OUT}=40mA$ $-40^\circ C \leq T_{opr} \leq 85^\circ C$	-	± 100	-	ppm/°C	②

■ ELECTRICAL CHARACTERISTICS (Continued)

XC6201P332

$V_{OUT(T)}=3.3V$ (*1)

$T_a=25^\circ C$

PARAMETER	SYMBOL	CONDITIONS	MIN.	TYP.	MAX.	UNITS	CIRCUIT
Output Voltage	$V_{OUT(E)}$ (*2)	$V_{IN}=4.3V$ $I_{OUT}=40mA$	3.234	3.300	3.366	V	②
Maximum Output Current	I_{OUTmax}	$V_{IN}=4.3V$ $V_{OUT(E)} \geq 2.97V$	150	-	-	mA	②
Load Regulation	ΔV_{OUT}	$V_{IN}=4.3V$ $1mA \leq I_{OUT} \leq 80mA$	-	20	50	mV	②
Dropout Voltage (*3)	Vdif1	$I_{OUT}=80mA$	-	200	360	mV	②
	Vdif2	$I_{OUT}=160mA$	-	450	700		
Supply Current	I_{SS}	$V_{IN}=4.3V$	-	2.0	5.0	μA	①
Line Regulation	$\frac{\Delta V_{OUT}}{\Delta V_{IN} \cdot \Delta V_{OUT}}$	$I_{OUT}=40mA$ $4.3V \leq V_{IN} \leq 10.0V$	-	0.2	0.3	%/V	②
Input Voltage	V_{IN}		1.8	-	10	V	-
Output Voltage Temperature Characteristics	$\frac{\Delta V_{OUT}}{\Delta T_{opr} \cdot \Delta V_{OUT}}$	$I_{OUT}=40mA$ $-40^\circ C \leq T_{opr} \leq 85^\circ C$	-	± 100	-	ppm/ $^\circ C$	②

XC6201P502

$V_{OUT(T)}=5.0V$ (*1)

$T_a=25^\circ C$

PARAMETER	SYMBOL	CONDITIONS	MIN.	TYP.	MAX.	UNITS	CIRCUIT
Output Voltage	$V_{OUT(E)}$ (*2)	$V_{IN}=6.0V$ $I_{OUT}=40mA$	4.900	5.000	5.100	V	②
Maximum Output Current	I_{OUTmax}	$V_{IN}=6.0V$ $V_{OUT(E)} \geq 4.57V$	200	-	-	mA	②
Load Regulation	ΔV_{OUT}	$V_{IN}=6.0V$ $1mA \leq I_{OUT} \leq 100mA$	-	30	70	mV	②
Dropout Voltage (*3)	Vdif1	$I_{OUT}=100mA$	-	160	340	mV	②
	Vdif2	$I_{OUT}=200mA$	-	400	600		
Supply Current	I_{SS}	$V_{IN}=6.0V$	-	2.0	6.0	μA	①
Line Regulation	$\frac{\Delta V_{OUT}}{\Delta V_{IN} \cdot \Delta V_{OUT}}$	$I_{OUT}=40mA$ $6.0V \leq V_{IN} \leq 10.0V$	-	0.2	0.3	%/V	②
Input Voltage	V_{IN}		1.8	-	10	V	-
Output Voltage Temperature Characteristics	$\frac{\Delta V_{OUT}}{\Delta T_{opr} \cdot \Delta V_{OUT}}$	$I_{OUT}=40mA$ $-40^\circ C \leq T_{opr} \leq 85^\circ C$	-	± 100	-	ppm/ $^\circ C$	②

NOTE:

*1: $V_{OUT(T)}$ = Nominal output voltage.

*2: $V_{OUT(E)}$ = Effective output voltage (i.e. the output voltage when " $V_{OUT(T)}+1.0V$ " is provided while maintaining a certain I_{OUT} value).

*3: $V_{dif} = (V_{IN1} - V_{OUT1})$

V_{IN1} : An Input Voltage when V_{OUT1} appears as the input voltage is gradually decreased.

V_{OUT1} : A voltage equal to 98% of the output voltage when a stabilized ($V_{OUT(T)} + 1.0V$) is input.

TYPICAL APPLICATION CIRCUIT

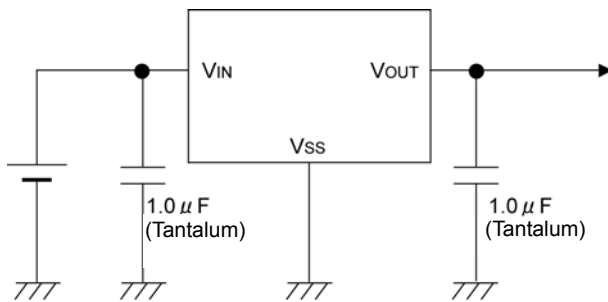

With the XC6201 series regulator, in order to ensure the stabilized output voltage, we suggest that an output capacitor (C_L) of $1 \mu F$ or more be connected between the output pin (V_{OUT}) and the V_{SS} pin. For using low ESR capacitor (e.g. ceramic capacitors), please make sure that the output voltage is more than 1.7V. When the output voltage is from 1.3V to 1.6V, the output capacitor should be a tantalum capacitor with a capacitance of $2.2 \mu F$. We also suggest an input capacitor (C_{IN}) should be connected between the V_{IN} and the V_{SS} in order to stabilize input power source.

OUTPUT VOLTAGE	C_{IN}	C_L (TANTALUM)	C_L (LOW ESR)
1.3V~1.6V	$\geq 1.0 \mu F$	$\geq 2.2 \mu F$	—
1.7V~6.0V	$\geq 1.0 \mu F$	$\geq 1.0 \mu F$	$\geq 1.0 \mu F$

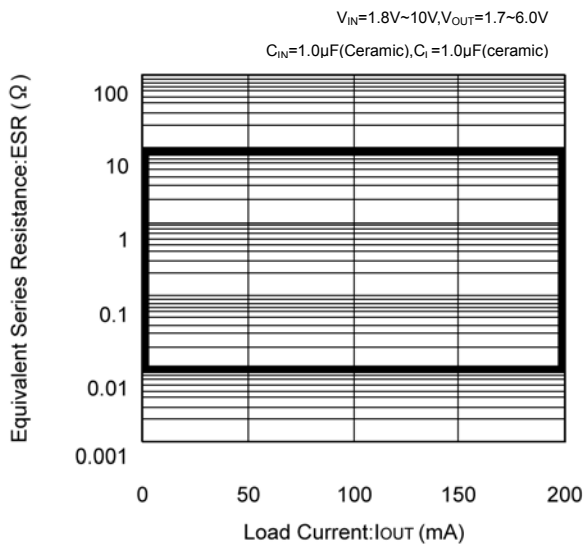

■ TEST CIRCUITS

Circuit ① : Supply Current

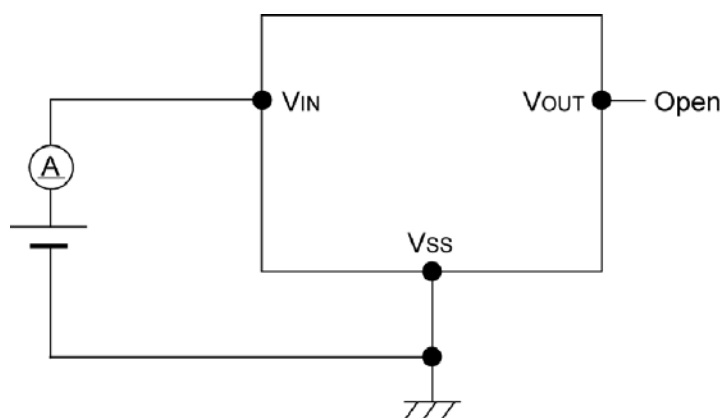

Circuit ② : Output Voltage, Oscillation, Line Regulation, Dropout Voltage, Load Regulation

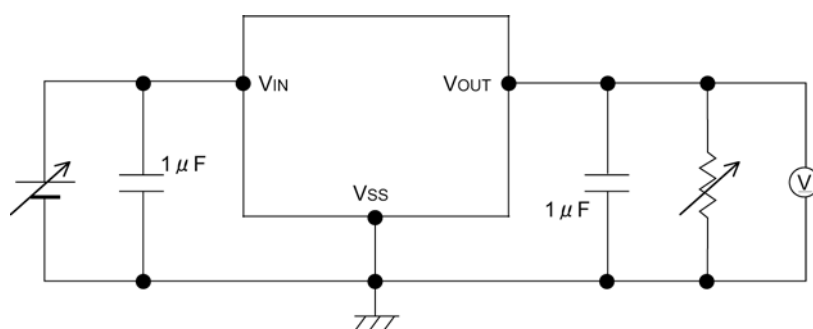

■ NOTE ON USE

1. Please use this IC within the stated absolute maximum ratings. The IC is liable to malfunction should the ratings be exceeded. When a voltage higher than the VIN flows to the VOUT like when using two power supplies, please connect a Schottky barrier diode between the VOUT and the VIN and do not exceed the VOUT rating.

2. An oscillation may occur by the impedance between a power supply and the input of the IC. Where the impedance is 10Ω or more, please use an input capacitor (CIN) of at least 1 μF. In case of high output current, operation can be stabilized by increasing the input capacitor value. Also an oscillation may occur if the input capacitor value is smaller than the input impedance when the output capacitance (CL) is large. In such cases, operations can be stabilized by either increasing the input capacitor value or reducing the output capacitor value.

3. Please ensure that output current (IOUT) is less than $Pd / (VIN - VOUT)$ and do not exceed the rated power dissipation value (Pd) of the package.

TYPICAL PERFORMANCE CHARACTERISTICS

(1) Output Voltage vs. Output Current

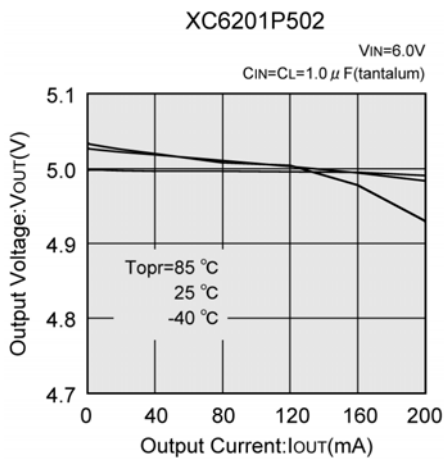
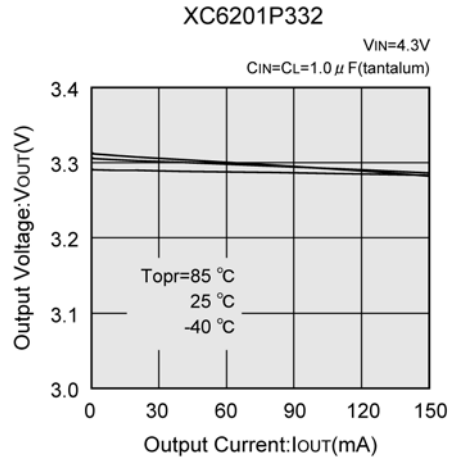
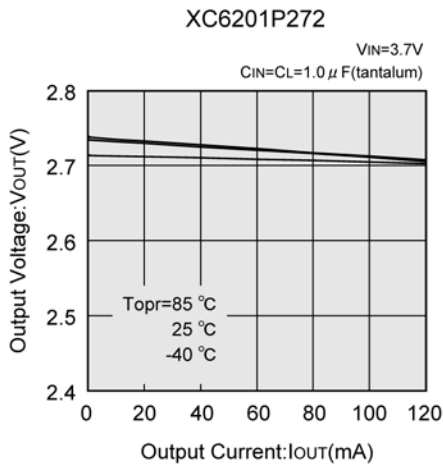
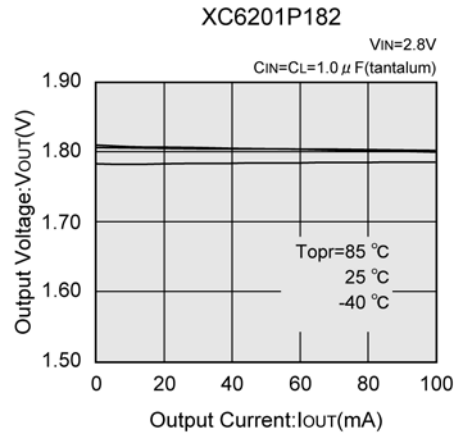
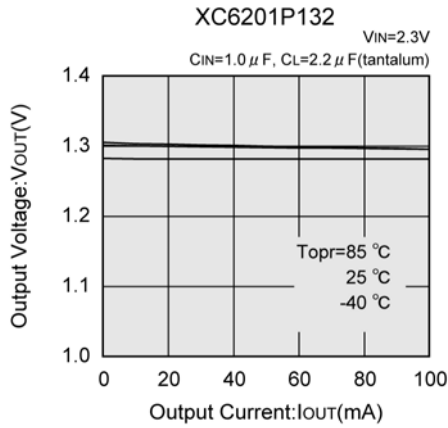

■ TYPICAL PERFORMANCE CHARACTERISTICS (Continued)

(2) Output Voltage vs. Input Voltage

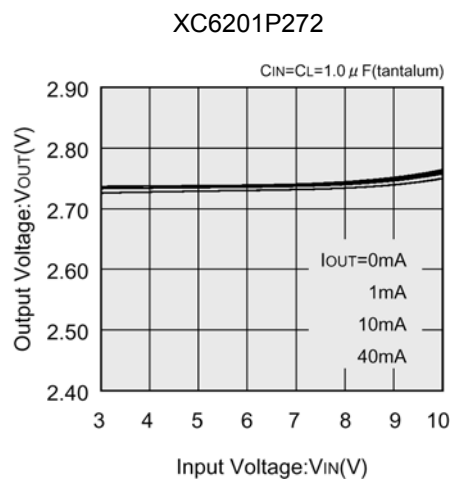
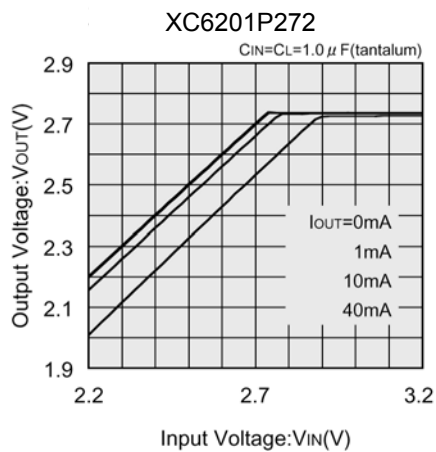
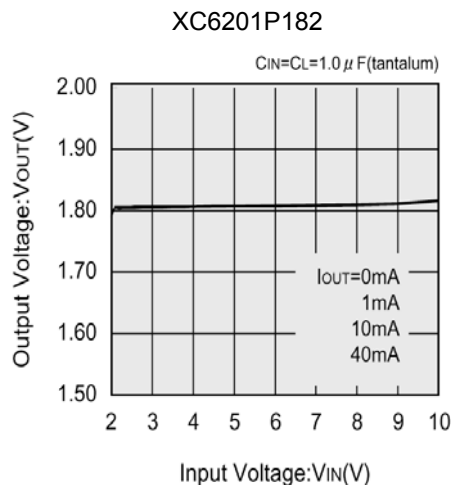
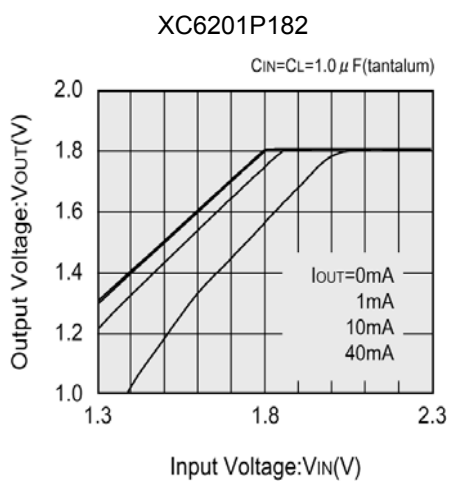
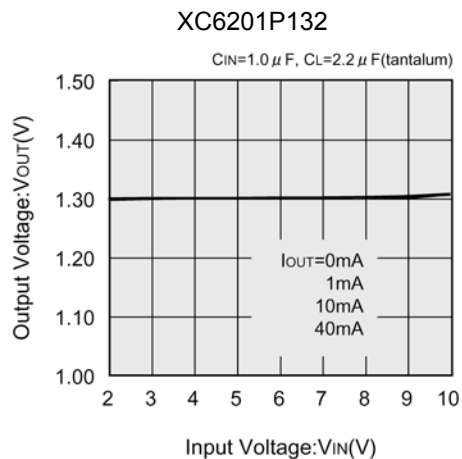
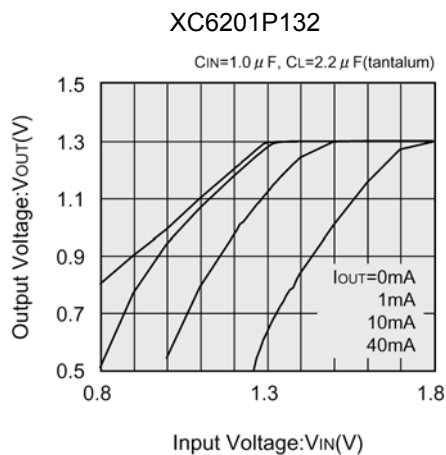

■ TYPICAL PERFORMANCE CHARACTERISTICS (Continued)

(2) Output Voltage vs. Input Voltage (Continued)

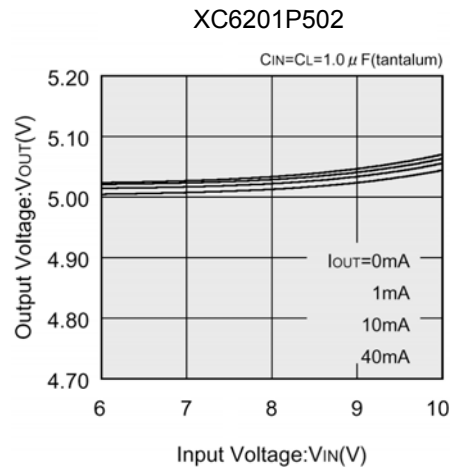
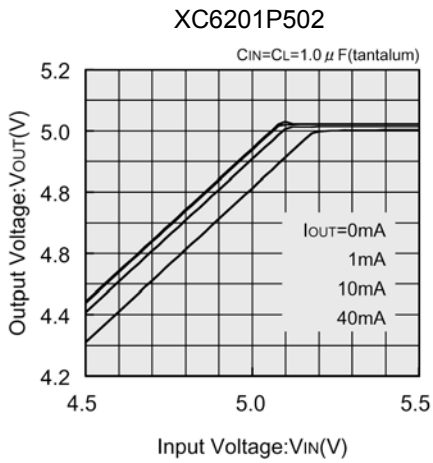
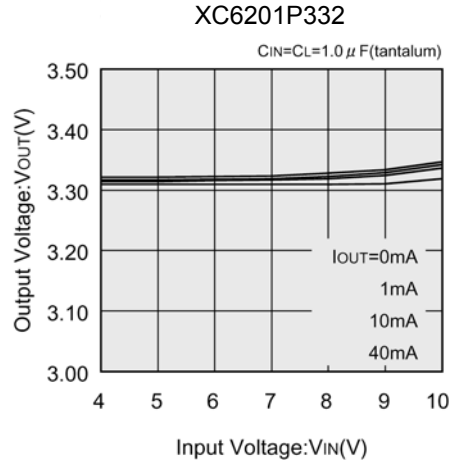
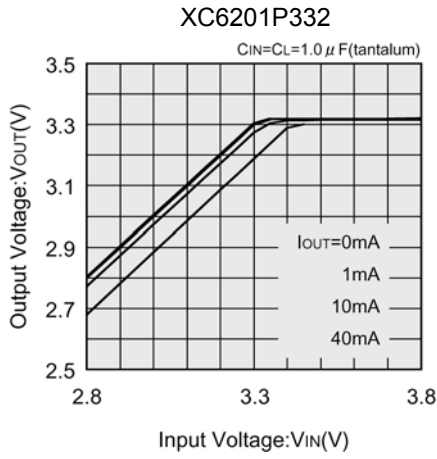

■ TYPICAL PERFORMANCE CHARACTERISTICS (Continued)

(3) Dropout Voltage vs. Output Current

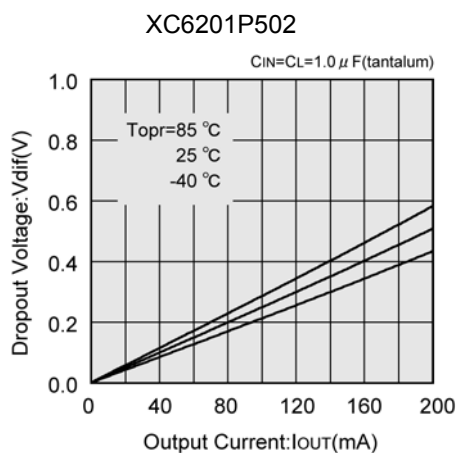
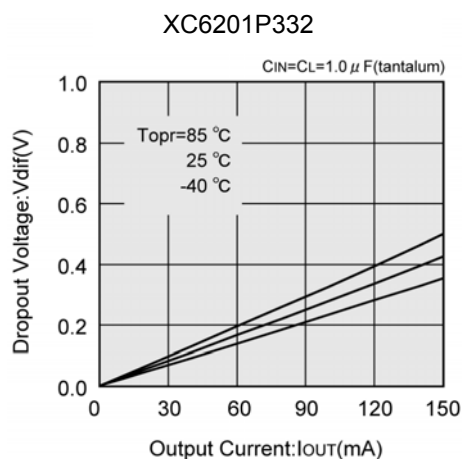
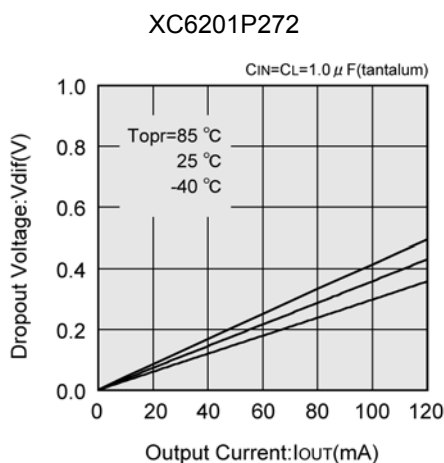
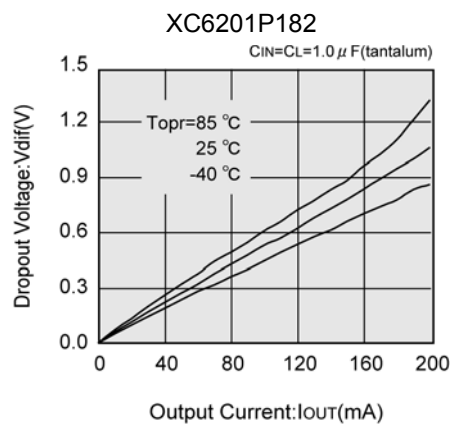
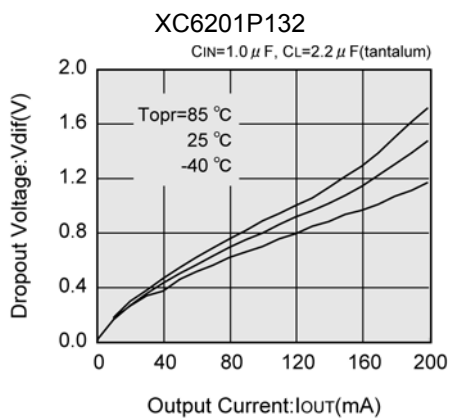

TYPICAL PERFORMANCE CHARACTERISTICS (Continued)

(4) Supply Current vs. Input Voltage

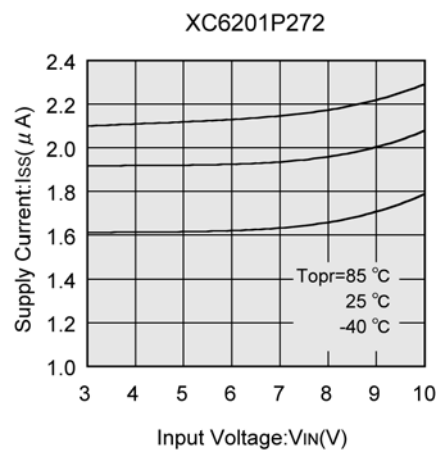
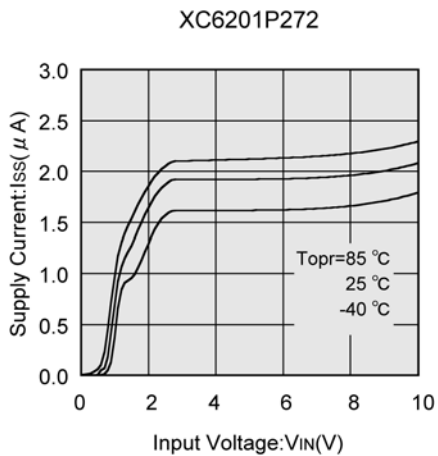
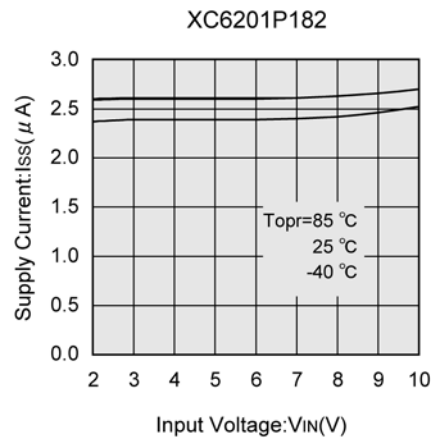
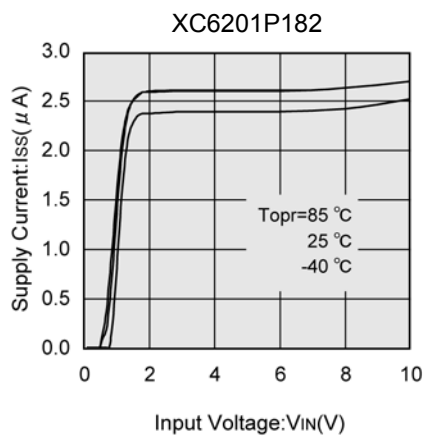
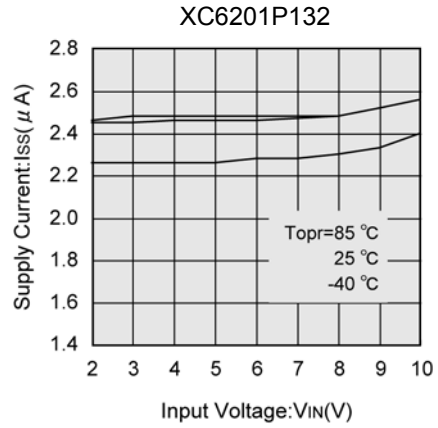
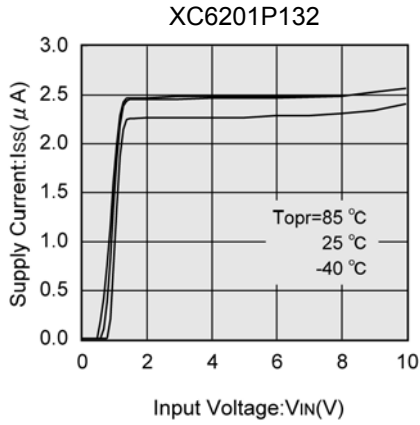

■ TYPICAL PERFORMANCE CHARACTERISTICS (Continued)

(4) Supply Current vs. Input Voltage (Continued)

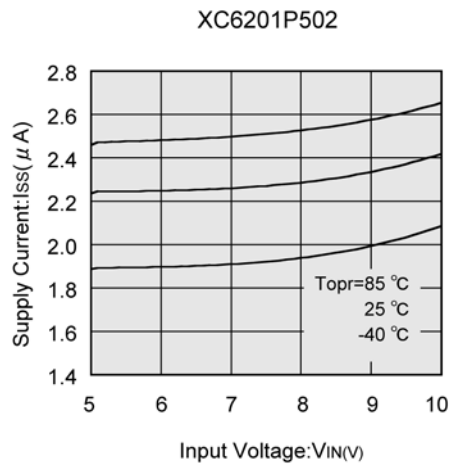
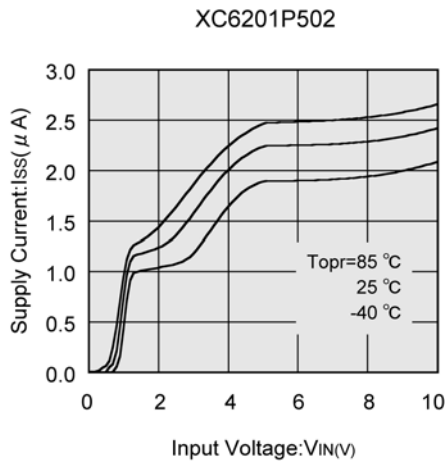
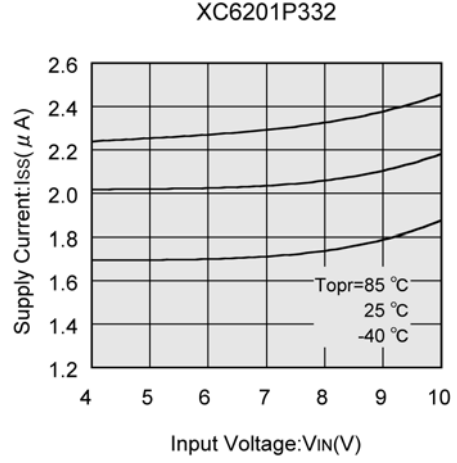
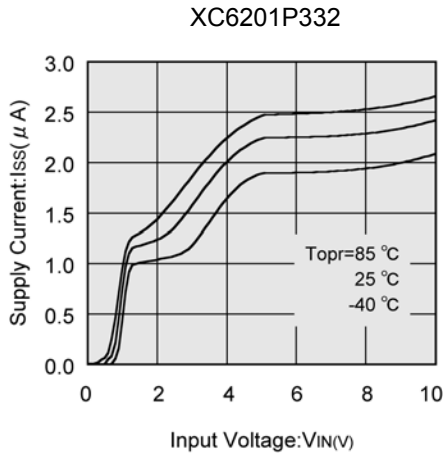

TYPICAL PERFORMANCE CHARACTERISTICS (Continued)

(5) Output Voltage vs. Ambient Temperature

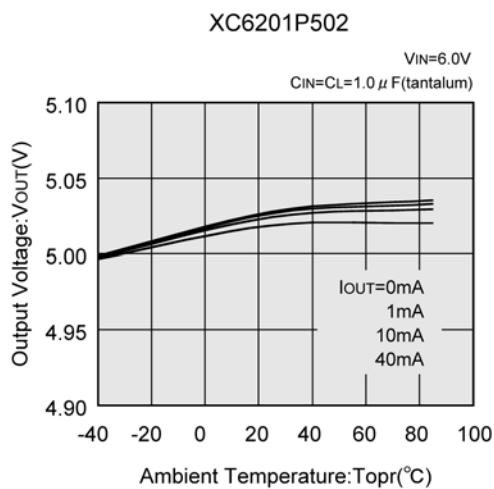
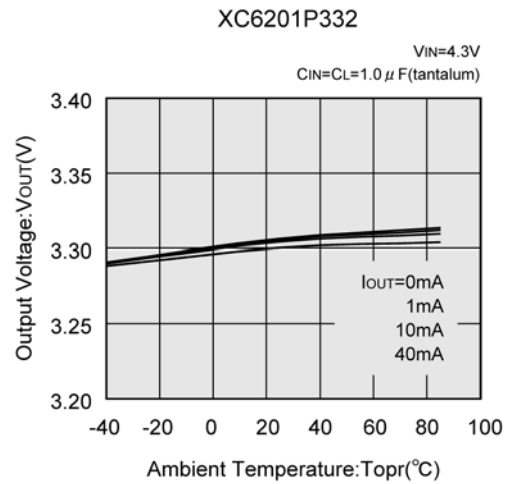
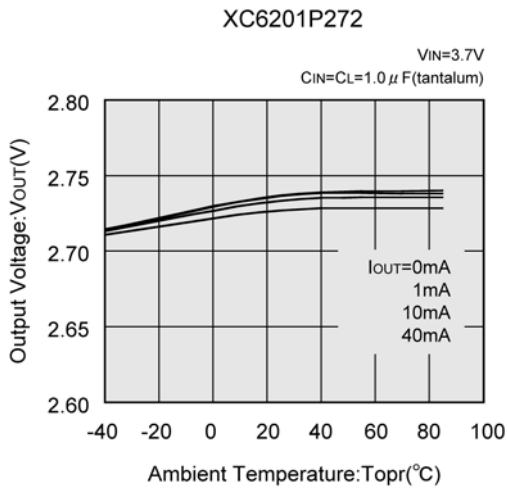
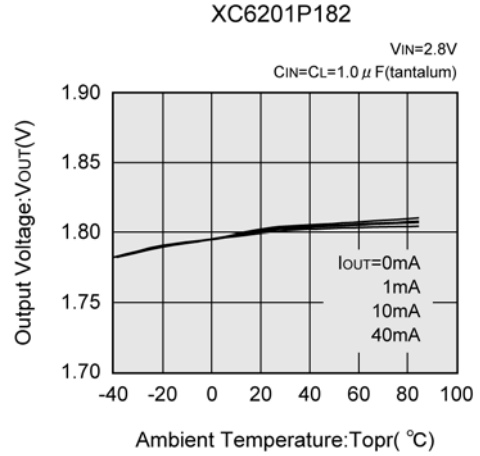
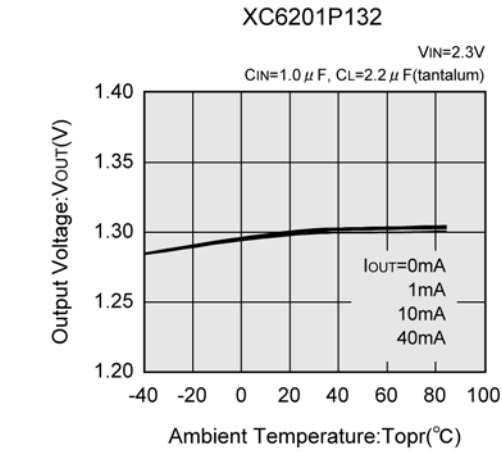

■ TYPICAL PERFORMANCE CHARACTERISTICS (Continued)

(6) Supply Current vs. Ambient Temperature

XC6201P132

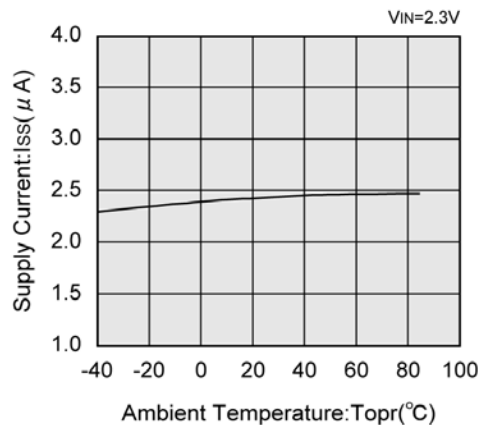

XC6201P182

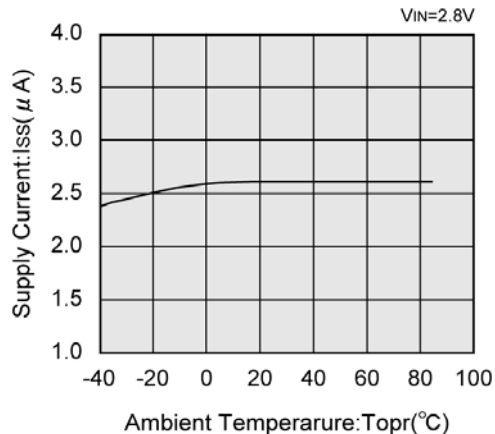

XC6201P272

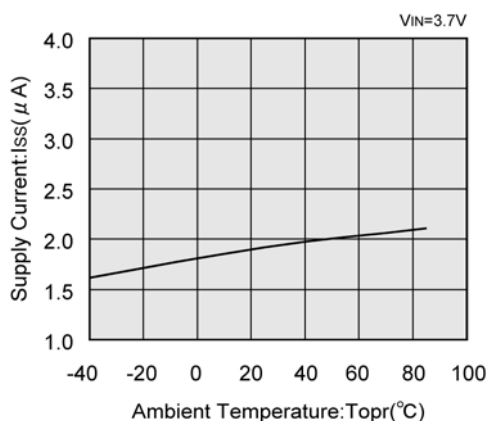

XC6201P332

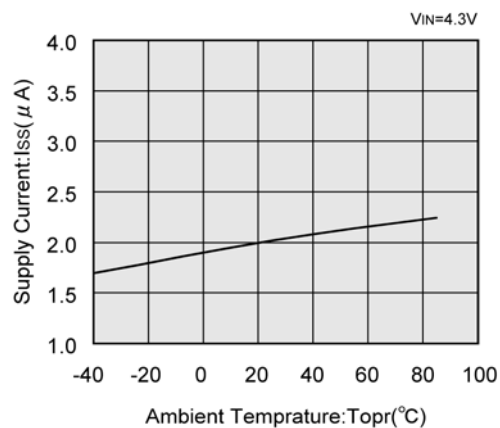

XC6201P502

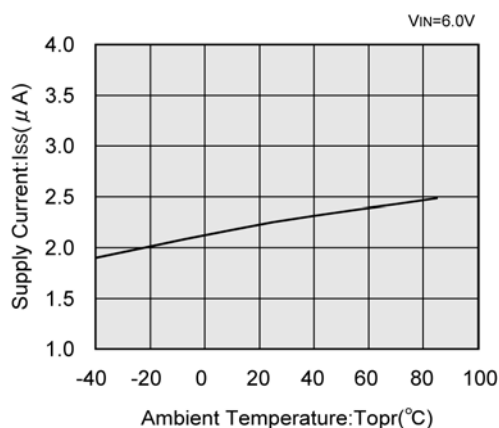

TYPICAL PERFORMANCE CHARACTERISTICS (Continued)

(7) Input Transient Response

XC6201P132

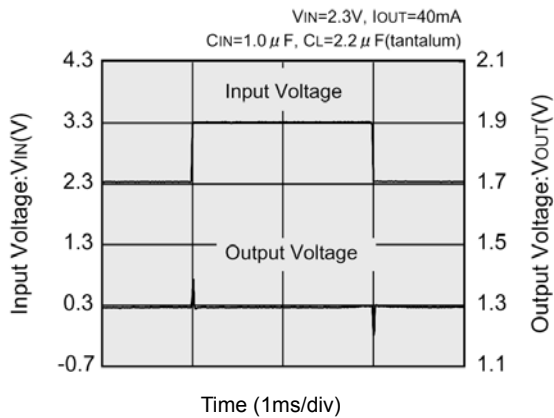

XC6201P182

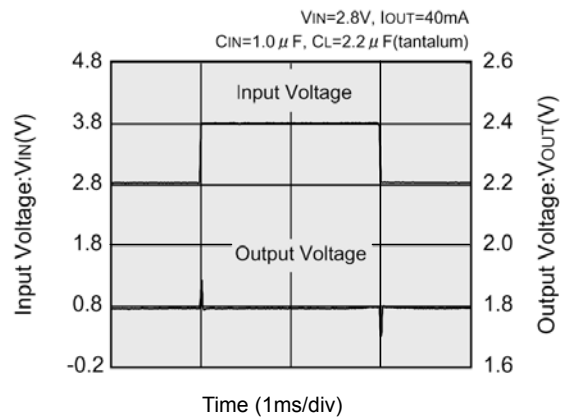

XC6201P272

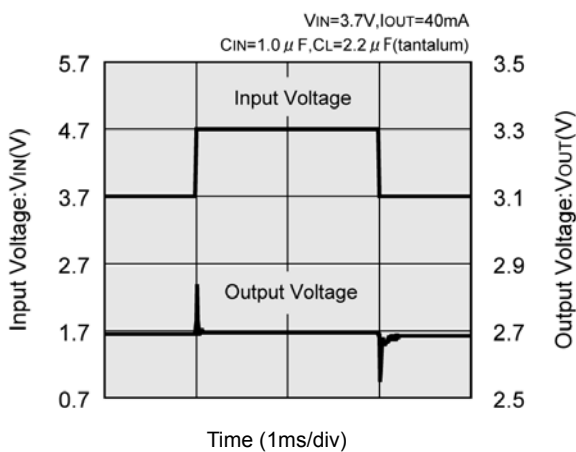

XC6201P332

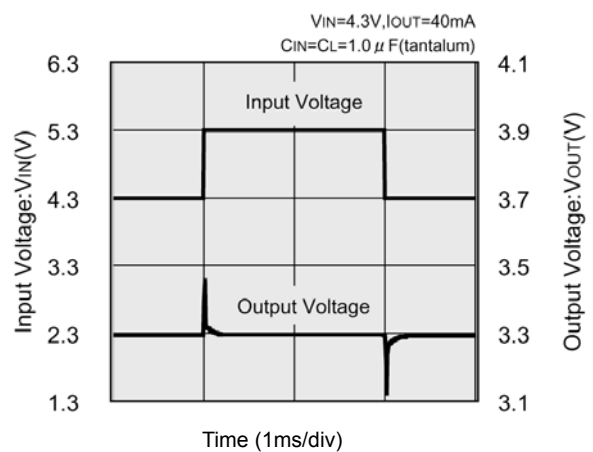

XC6201P502

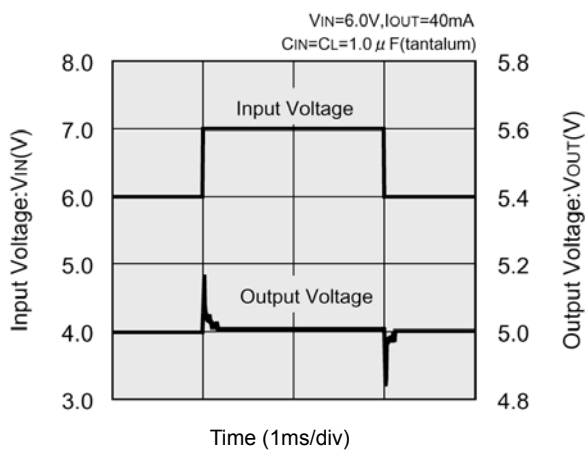

■ TYPICAL PERFORMANCE CHARACTERISTICS (Continued)

(8) Load Transient Response

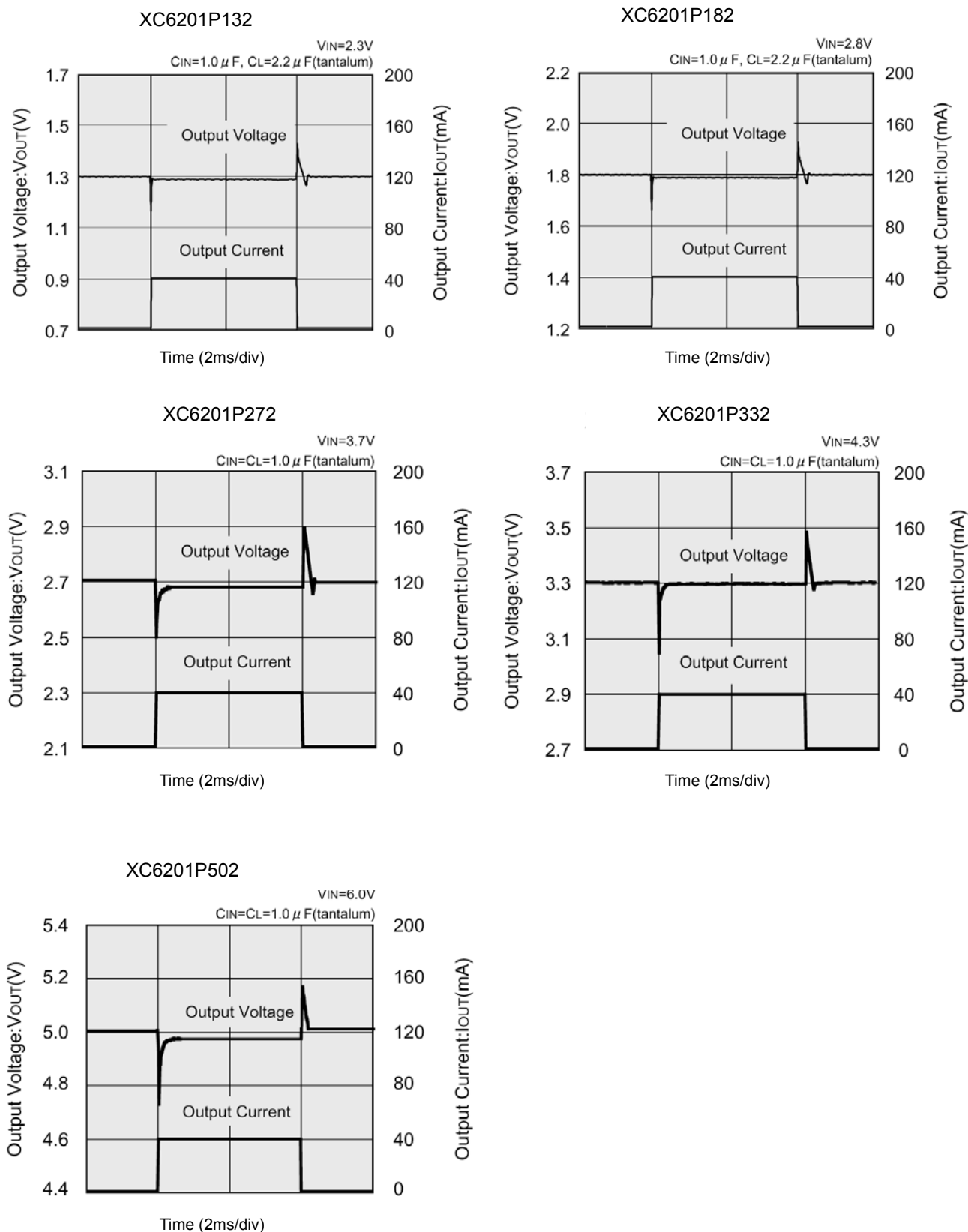

TYPICAL PERFORMANCE CHARACTERISTICS (Continued)

(9) Ripple Rejection Rate

XC6201P132

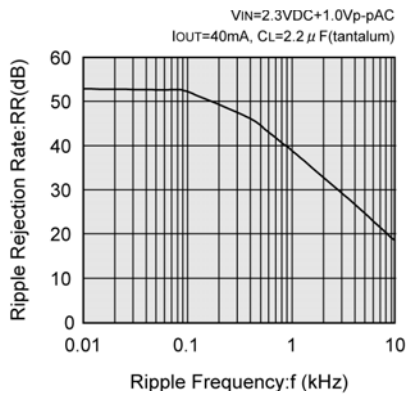

XC6201P182

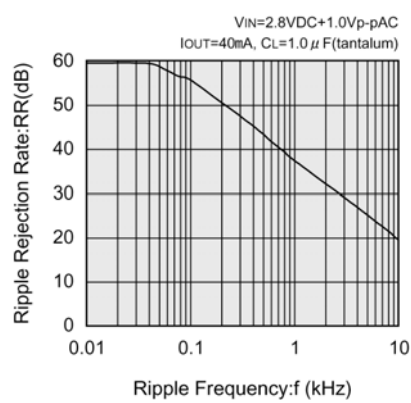

XC6201P272

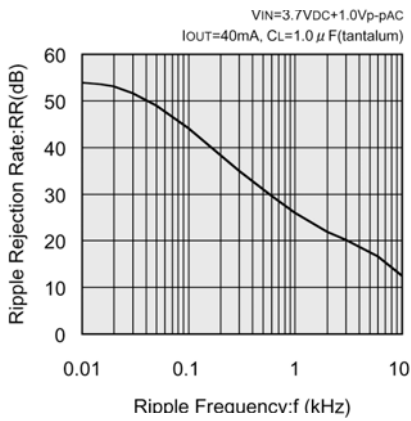

XC6201P332

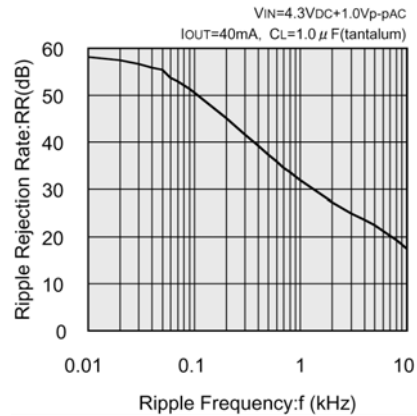

XC6201P502

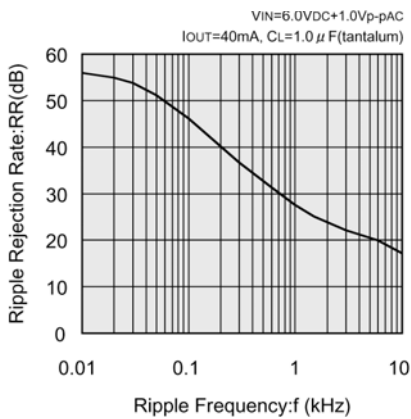

(10) Output Noise Density

XC6201P302

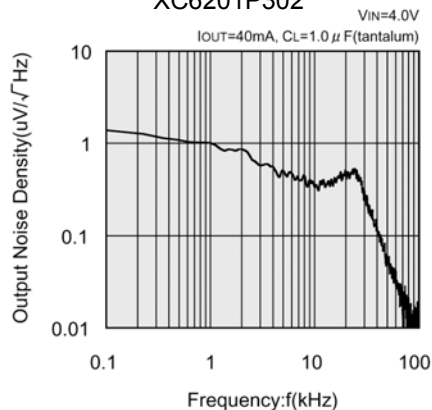

PACKAGING INFORMATION

● SOT-25

Unit : mm

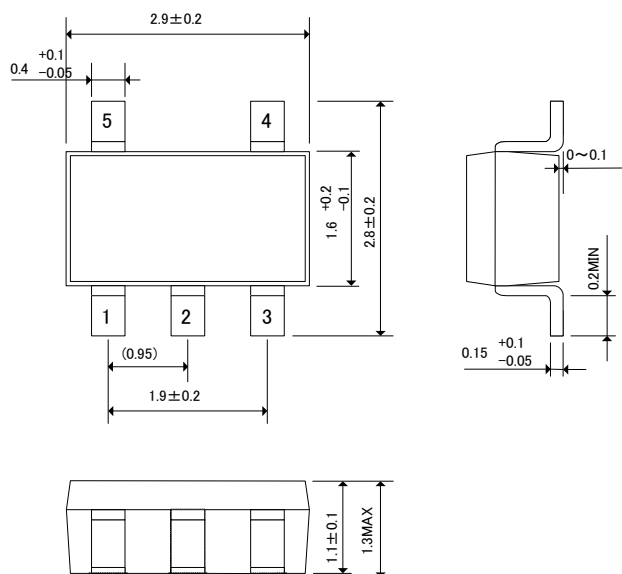

● SOT-89

Unit : mm

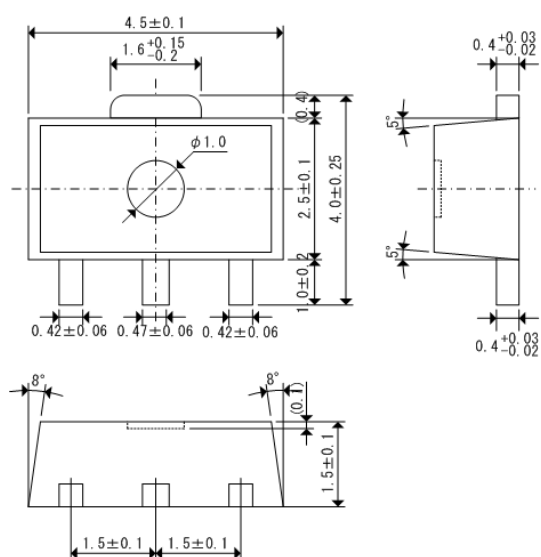

PACKAGING INFORMATION (Continued)

●TO-92

Paper type

Unit : mm

Bag

Unit : mm

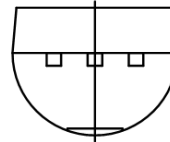
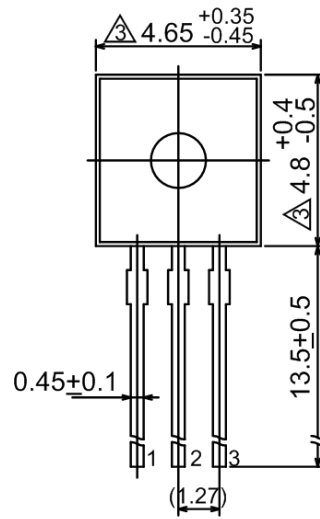
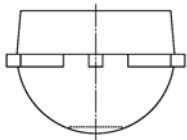
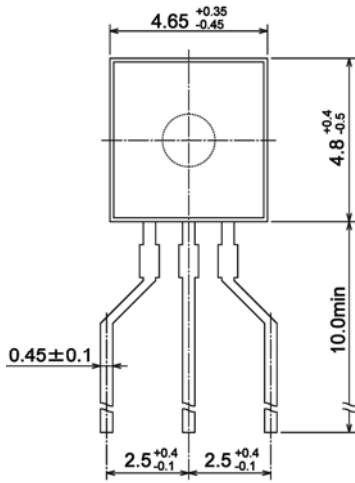

●USP-6B

Unit : mm

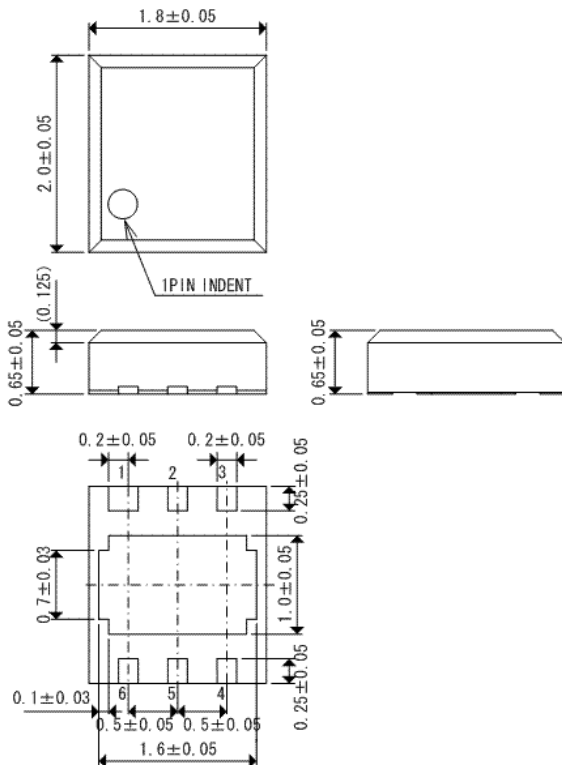

■ **PACKAGING INFORMATION (Continued)**

● USP-6B Reference Pattern Layout

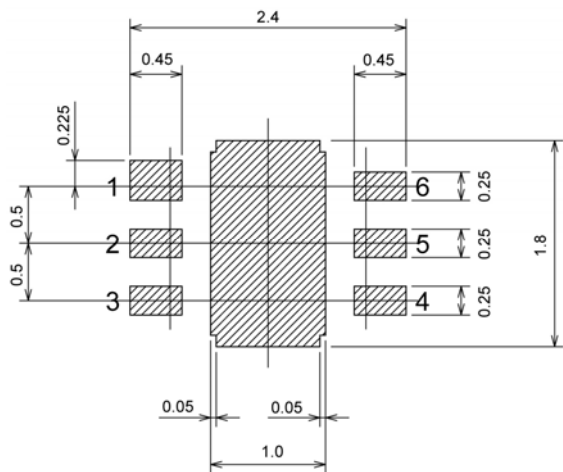

● USP-6B Reference Metal Mask Design

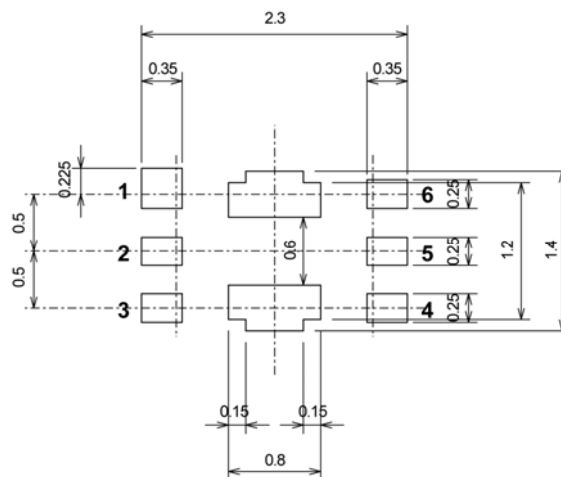

MARKING RULE

● SOT-89, SOT-25

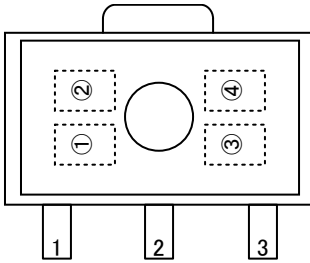

SOT-89
(TOP VIEW)

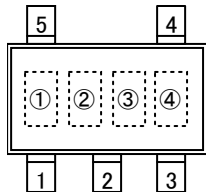

SOT-25
(TOP VIEW)

① represents the product series

MARK	PRODUCT SERIES
1	XC6201xxxxxx

② represents type of regulator

MARK		PRODUCT SERIES
Voltage= 0.1 ~ 3.0V	Voltage= 3.1 ~ 6.0V	
5	6	XC6201PXXXXX
8	9	XC6201TXXXXPX

③ represents output voltage

MARK	OUTPUT VOLTAGE (V)			MARK	OUTPUT VOLTAGE (V)		
0	—	3.1	—	F	1.6	4.6	—
1	—	3.2	—	H	1.7	4.7	—
2	—	3.3	—	K	1.8	4.8	—
3	—	3.4	—	L	1.9	4.9	—
4	—	3.5	—	M	2.0	5.0	—
5	—	3.6	—	N	2.1	5.1	—
6	—	3.7	—	P	2.2	5.2	—
7	—	3.8	—	R	2.3	5.3	—
8	—	3.9	—	S	2.4	5.4	—
9	—	4.0	—	T	2.5	5.5	—
A	—	4.1	—	U	2.6	5.6	—
B	—	4.2	—	V	2.7	5.7	—
C	1.3	4.3	—	X	2.8	5.8	—
D	1.4	4.4	—	Y	2.9	5.9	—
E	1.5	4.5	—	Z	3.0	6.0	—

④ represents assembly lot number

0 to 9, A to Z repeated (G, I, J, O, Q, W excluded)

MARKING RULE (Continued)

● TO-92

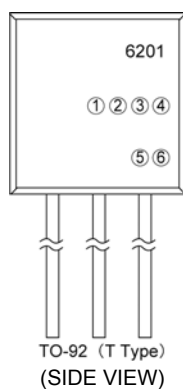

① represents type of regulator

MARK	PRODUCT SERIES
P	XC6201Pxxxx
T	XC6201Txxxx

②③ represents output voltage

MARK		VOLTAGE (V)	PRODUCT SERIES
②	③		
3	3	3.3	XC6201Px33xx
5	0	5.0	XC6201Px50xx

④ represents detect voltage accuracy

MARK	DETECT VOLTAGE ACCURACY	PRODUCT SERIES
1	Within $\pm 1\%$	XC6201Pxx1xx
2	Within $\pm 2\%$	XC6201Pxx2xx

⑤ represents least significant digit of production year

MARK	PRODUCTION YEAR
3	2003
4	2004

⑥ represents the production lot number

0 to 9, A to Z repeated (G, I, J, O, Q, W excluded)

Note: No character inversion used.

● USP-6B

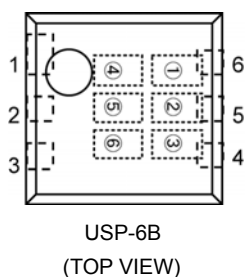

①② represents product series

MARK		PRODUCT SERIES
①	②	
0	1	XC6201xxxxDx

③ represents type of regulator

MARK	TYPE	PRODUCT SERIES
P	3pin Regulator	XC6201PxxxDx
T	$V_{IN}=7V(\text{Rated})$	XC6201TxxxDx

④⑤ represents output voltage

MARK		VOLTAGE (V)	PRODUCT SERIES
④	⑤		
3	3	3.3	XC6201x33xDx
5	0	5.0	XC6201x50xDx

⑥ represents assembly lot number

0 to 9, A to Z repeated (G, I, J, O, Q, W excluded)

Note: No character inversion used.