

High Speed LDO Regulators Low ESR Cap.Compatible,Output ON/OFFControl

GENERAL DESCRIPTION

The XC6209 series are highly precise, low noise, positive voltage LDO regulators manufactured using CMOS processes. The series achieves high ripple rejection and low dropout and consists of a voltage reference, an error amplifier, a current limiter and a phase compensation circuit plus a driver transistor.

Output voltage is selectable in 0.05V increments within a range of 0.9V ~ 6.0V.

The series is also compatible with low ESR ceramic capacitors which give added output stability. This stability can be maintained even during load fluctuations due to the excellent transient response of the series. The current limiter's foldback circuit also operates as a short protect for the output current limiter and the output pin.

The CE function enables the output to be turned off, resulting in greatly reduced power consumption.

APPLICATIONS

- Smart phones / Mobile phones
- Portable game consoles
- Digital still cameras / Camcorders
- Digital audio equipments
- Reference voltage sources
- Multi-function power supplies

FEATURES

- Maximum Output Current** : 150mA
(300mA=XC6209 E to H types)
- Dropout Voltage** : 60mV @ 30mA
: 200mV @ 100mA
- Maximum Operating Voltage** : 2.0V ~ 10V
- Output Voltage Range** : 0.9V ~ 6.0V(0.05V increments)
- Highly Accurate** : $\pm 2\%$ ($V_{OUT} > 1.5V$)
: $\pm 30mV$ ($V_{OUT} = 1.5V$)
- Low Power Consumption** : 25 μA (TYP.)
- Standby Current** : Less than 0.1 μA (TYP.)
- High Ripple Rejection** : 70dB (10kHz)
- Operating Ambient Temperature** : -40 ~ +85
- Low ESR Capacitor Compatible** : Ceramic capacitor
- Packages** : SOT-25
USP-6B
SOT-89-5
- Environmentally Friendly** : EU RoHS Compliant, Pb Free

TYPICAL APPLICATION CIRCUIT

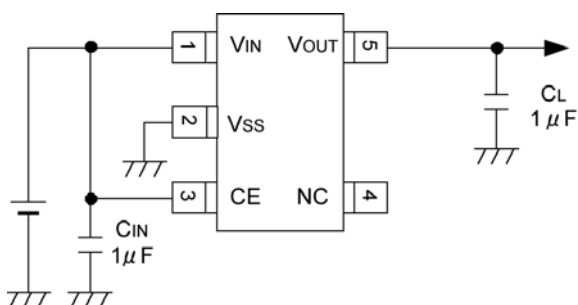

TYPICAL PERFORMANCE CHARACTERISTICS

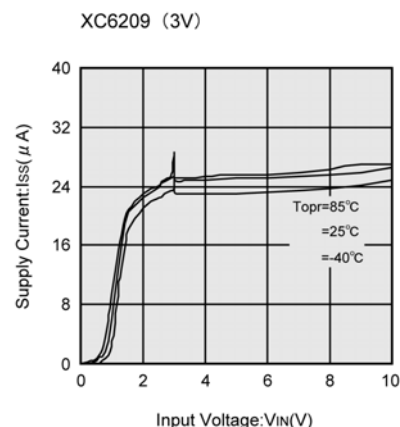

PIN CONFIGURATION



*The dissipation pad for the USP-6B package should be solder-plated in recommended mount pattern and metal masking so as to enhance mounting strength and heat release. If the pad needs to be connected to other pins, it should be connected to the Vss pin.

PIN ASSIGNMENT

PIN NUMBER			PIN NAME	FUNCTIONS
SOT-25	SOT-89-5	USP-6B		
1	4	1	VIN	Input
2	2	5	VSS	Ground
3	3	6	CE	ON/OFF Control
4	1	2,4	NC	No Connection
5	5	3	VOUT	Output

FUNCTIONS

TYPE	CE	OPERATIONAL STATE
Type A, B, E, F	H	ON
	L	OFF
Type C, D, G, H	H	OFF
	L	ON

H=High Level

L=Low Level

PRODUCT CLASSIFICATION

Ordering Information
XC6209 -

DESIGNATOR	ITEM	SYMBOL	DESCRIPTION
	Type of Regulator CE Pin Logic	A	150mA, Active High, Pull-down resistor built-in ^{(*)2} (Semi-custom)
		B	150mA, Active High, No pull-down resistor (Standard)
		C	150mA, Active Low, Pull-up resistor built-in ^{(*)2} (Semi-custom)
		D	150mA, Active Low, No pull-up resistor (Semi-custom)
		E	300mA ^{(*)1} , Active High, Pull-down resistor built-in ^{(*)2} (Semi-custom)
		F	300mA ^{(*)1} , Active High, No pull-down resistor (Standard)
		G	300mA ^{(*)1} , Active Low, Pull-up resistor built-in ^{(*)2} (Semi-custom)
		H	300mA ^{(*)1} , Active Low, No pull-up resistor (Semi-custom)
	Output Voltage	09 ~ 60	Output Voltage Range: 0.9V ~ 6.0V e.g.: 3.0V =3, =0
		30 ~ 60	For 1% product, output voltage range is 3.0V ~ 6.0V.
	Output Voltage Accuracy	2	0.1V increments, Accuracy: $\pm 2\%$ ^{(*)3} e.g.: 2.80V =2, =8, =2
		1	0.1V increments, Accuracy: $\pm 1\%$ e.g.: 3.00V =3, =0, =1
		A	0.05V increments, Accuracy: $\pm 2\%$ ^{(*)3} e.g.: 2.85V =2, =8, =A
		B	0.05V increments, Accuracy: $\pm 1\%$ e.g.: 3.05V =3, =0, =B
- ^{(*)4}	Packages (Order Unit)	MR	SOT-25 (3,000/Reel)
		MR-G	SOT-25 (3,000/Reel)
		PR	SOT-89-5 (1,000/Reel)
		PR-G	SOT-89-5 (1,000/Reel)
		DR	USP-6B (3,000/Reel)
		DR-G	USP-6B (3,000/Reel)

^{(*)1} The maximum output current of type E ~ H depends on setting output voltage.

^{(*)2} With the pull-up resistor or pull-down resistor built-in types, the supply current during operation will increase by $V_{IN} / 2M\Omega$ (TYP.).

^{(*)3} The output voltage accuracy is $\pm 30mV$ at $V_{OUT} = 1.5V$.

^{(*)4} The "-G" suffix denotes Halogen and Antimony free as well as being fully EU RoHS compliant.

BLOCK DIAGRAM

XC6209 Type A, E



XC6209 Type B, D, F, H



XC6209 Type C, G



* Diodes inside the circuits are ESD protection diodes and parasitic diodes.

ABSOLUTE MAXIMUM RATINGS

Ta=25

PARAMETER		SYMBOL	RATINGS	UNITS
Input Voltage		V _{IN}	12.0	V
Output Current		I _{OUT}	500 ^(*)	mA
Output Voltage		V _{OUT}	V _{SS} - 0.3 ~ V _{IN} + 0.3	V
CE Input Voltage		V _{CE}	V _{SS} - 0.3 ~ V _{IN} + 0.3	V
Power Dissipation	SOT-25	P _d	250	mW
			600(PCB mounted) ^(**)	
	SOT-89-5		500	
			1300(PCB mounted) ^(**)	
	USP-6B		120	
			1000(PCB mounted) ^(**)	
Operating Ambient Temperature		T _{opr}	-40 ~ +85	
Storage Temperature		T _{stg}	-55 ~ +125	

All voltages are described based on the V_{SS}.

^(*) I_{OUT} P_d/(V_{IN}-V_{OUT})

^(**) This is a reference data taken by using the test board. Please refer to page 25 to 27 for details.

ELECTRICAL CHARACTERISTICS

XC6209 (Type A, B)

Ta=25

PARAMETER	SYMBOL	CONDITIONS	MIN.	TYP.	MAX.	UNITS	CIRCUIT
Output Voltage (2%) ^{(*)5}	V _{OUT(E)} ^{(*)3}	I _{OUT} =30mA	V _{OUT(T)} ^{(*)2} ×0.98	V _{OUT(T)} ^{(*)2}	V _{OUT(T)} ^{(*)2} ×1.02	V	
Output Voltage (1%) ^{(*)6}			V _{OUT(T)} ^{(*)2} ×0.99		V _{OUT(T)} ^{(*)2} ×1.01		
Maximum Output Current	I _{OUTMAX}	-	150	-	-	mA	
Load Regulation	V _{OUT}	1mA I _{OUT} 100mA	-	15	50	mV	
Dropout Voltage ^{(*)4}	V _{dif1}	I _{OUT} =30mA	E-1			mV	
	V _{dif2}	I _{OUT} =100mA	E-2			mV	
Supply Current (Type A)	I _{DD}	V _{CE} =V _{IN} =V _{OUT(T)} +1.0V	-	28	55	μA	
Supply Current (Type B)		When V _{OUT} 0.95V, V _{IN} =V _{CE} =2.0V	-	25	50		
Stand-by Current	I _{STB}	V _{IN} =V _{OUT(T)} +1.0V, V _{CE} =V _{SS} When V _{OUT} 0.95V, V _{IN} =2.0V	-	0.01	0.10	μA	
Line Regulation	V _{OUT} / (V _{IN} ·V _{OUT})	V _{OUT(T)} +1.0V V _{IN} 10V When V _{OUT} 0.95, 2.0V=V _{IN} 10V I _{OUT} =30mA When V _{OUT} 1.75V, I _{OUT} =10mA	-	0.01	0.20	%/V	
Input Voltage	V _{IN}		2	-	10	V	-
Output Voltage Temperature Characteristics	V _{OUT} / (T _{opr} ·V _{OUT})	I _{OUT} =30mA -40 T _{opr} 85	-	100	-	ppm/	
Power Supply Rejection Ratio	PSRR	V _{IN} =[V _{OUT(T)} +1.0]V+1.0Vp-p _{AC} When V _{OUT} 1.5V, V _{IN} =2.5V+1.0Vp-p _{AC} I _{OUT} =50mA, f=10kHz	-	70	-	dB	
Current Limit	I _{lim}	V _{IN} =V _{OUT(T)} +1.0V, V _{CE} =V _{SS} When V _{OUT} 1.75, V _{IN} =V _{OUT(T)} +2.0V	-	300	-	mA	
Short Current	I _{SHORT}	V _{IN} =V _{OUT(T)} +1.0V, V _{CE} =V _{SS} When V _{OUT} 1.75, V _{IN} =V _{OUT(T)} +2.0V	-	50	-	mA	
CE "H" Level Voltage	V _{CEH}	-	1.6	-	V _{IN}	V	
CE "L" Level Voltage	V _{CEL}	-	-	-	0.25	V	
CE "H" Level Current (Type A)	I _{CEH}	V _{IN} =V _{CE} =V _{OUT(T)} +1.0V, When V _{OUT} 0.95V, V _{IN} =V _{CE} =2.0V	0.8	-	5.0	μA	
CE "H" Level Current (Type B)			-0.1	-	0.1		
CE "L" Level Current	I _{CEL}	V _{IN} =V _{OUT(T)} +1.0V, V _{CE} =V _{SS} When V _{OUT} 0.95V, V _{IN} =2.0V	-0.1	-	0.1	μA	

*1: Unless otherwise stated, V_{IN}=V_{OUT(T)}+1.0V. If V_{OUT} is less than 0.95V, V_{IN}=2.0V.

*2: V_{OUT(T)} is Nominal output voltage

*3: V_{OUT(E)} is Effective output voltage

(I.e. the output voltage when "V_{OUT(T)}+1.0V" is provided at the V_{IN} pin while maintaining a certain I_{OUT} value).

*4: V_{dif}={V_{IN1}-V_{OUT1}}

V_{OUT1} is the voltage equal to 98% of the output voltage whenever an amply stabilized V_{OUT(T)}+1.0V is input for every I_{OUT}.

V_{IN1} is the input voltage when V_{OUT1} appears while input voltage is gradually decreased.

*5: If V_{OUT(T)} is less than 1.45V, V_{OUT(T)}-30mV (MIN.), V_{OUT(T)}+30mV (MAX.)

*6: Only for the V_{OUT(T)} is more than 3.0V products.

ELECTRICAL CHARACTERISTICS

XC6209 (Type C, D)

Ta=25

PARAMETER	SYMBOL	CONDITIONS	MIN.	TYP.	MAX.	UNITS	CIRCUIT
Output Voltage ^(*5) (2%)	V _{OUT(E)} ^(*3)	I _{OUT} =30mA	V _{OUT(T)} ^(*2) ×0.98	V _{OUT(T)} ^(*2)	V _{OUT(T)} ^(*2) ×1.02	V	
Output Voltage ^(*6) (1%)			V _{OUT(T)} ^(*2) ×0.99		V _{OUT(T)} ^(*2) ×1.01		
Maximum Output Current	I _{OUTMAX}	-	150	-	-	mA	
Load Regulation	ΔV _{OUT}	1mA I _{OUT} 100mA	-	15	50	mV	
Dropout Voltage ^(*4)	V _{dif1}	I _{OUT} =30mA	-	E-1		mV	
	V _{dif2}	I _{OUT} =100mA	-	E-2			
Supply Current (Type C)	I _{DD}	V _{IN} =V _{OUT(T)} +1.0V	-	28	55	μA	
Supply Current (Type D)		When V _{OUT} 0.95V, V _{IN} =2.0V V _{CE} =V _{SS}	-	25	50		
Stand-by Current	I _{STB}	V _{IN} =V _{OUT(T)} +1.0V, V _{CE} =V _{IN} When V _{OUT} 0.95V, V _{IN} =V _{CE} =2.0V	-	0.01	0.10	μA	
Line Regulation	ΔV _{OUT} / (ΔV _{IN} · V _{OUT})	V _{OUT(T)} +1.0V V _{IN} 10V V _{OUT} 0.95V is 2.0V V _{IN} 10V I _{OUT} =30mA When V _{OUT} 1.75V, I _{OUT} =10mA	-	0.01	0.20	%/V	
Input Voltage	V _{IN}	-	2	-	10	V	-
Output Voltage Temperature Characteristics	ΔV _{OUT} / (ΔT _{opr} · V _{OUT})	I _{OUT} =30mA -40 T _{opr} 85	-	±100	-	ppm/	
Power Supply Rejection Ratio	PSRR	V _{IN} =[V _{OUT(T)} +1.0]V+1.0Vp-p _{AC} When V _{OUT} 1.5V, V _{IN} =2.5V+1.0Vp-p _{AC} I _{OUT} =50mA, f=10kHz	-	70	-	dB	
Current Limit	I _{lim}	V _{IN} =V _{OUT(T)} +1.0V, V _{CE} =V _{SS} When V _{OUT} 1.75V, V _{IN} =V _{OUT(T)} +2.0V	-	300	-	mA	
Short Current	I _{SHORT}	V _{IN} =V _{OUT(T)} +1.0V, V _{CE} =V _{SS} When V _{OUT} 1.75V, V _{IN} =V _{OUT(T)} +2.0V	-	50	-	mA	
CE "H" Level Voltage	V _{CEH}	-	1.6	-	V _{IN}	V	
CE "L" Level Voltage	V _{CEL}	-	-	-	0.25	V	
CE "H" Level Current	I _{CEH}	V _{CE} =V _{IN} =V _{OUT(T)} +1.0V When V _{OUT} 0.95V, V _{CE} =V _{IN} =2.0V	-0.1	-	0.1	μA	
CE "L" Level Current (Type C)	I _{CEL}	V _{IN} =V _{OUT(T)} +1.0V, V _{CE} =V _{SS} When V _{OUT} 0.95V, V _{IN} =2.0V	-5.0	-	-0.8	μA	
CE "L" Level Current (Type D)			-0.1	-	0.1		

*1: Unless otherwise stated, V_{IN}=V_{OUT(T)}+1.0V. If V_{OUT} is less than 0.95V, V_{IN}= 2.0V.

*2: V_{OUT(T)} is Nominal output voltage

*3: V_{OUT(E)} is Effective output voltage

(I.e. the output voltage when "V_{OUT(T)}+1.0V" is provided at the V_{IN} pin while maintaining a certain I_{OUT} value).

*4: V_{dif}={V_{IN1}-V_{OUT1}}

V_{OUT1} is the voltage equal to 98% of the output voltage whenever an amply stabilized V_{OUT(T)}+1.0V is input for every I_{OUT}.

V_{IN1} is the input voltage when V_{OUT1} appears while input voltage is gradually decreased.

*5: If V_{OUT(T)} is less than 1.45V, V_{OUT(T)}-30mV (MIN.), V_{OUT(T)} + 30mV (MAX.)

*6: Only for the V_{OUT(T)} is more than 3.0V products.

ELECTRICAL CHARACTERISTICS (Continued)

XC6209 (Type E,F)

Ta=25

PARAMETER	SYMBOL	CONDITIONS	MIN.	TYP.	MAX.	UNITS	CIRCUIT
Output Voltage (2%) ^(*5)	V _{OUT(E)} ^(*3)	I _{OUT} =30mA	V _{OUT(T)} ^(*2) ×0.98	V _{OUT(T)} ^(*2)	V _{OUT(T)} ^(*2) ×1.02	V	
Output Voltage (1%) ^(*6)			V _{OUT(T)} ^(*2) ×0.99		V _{OUT(T)} ^(*2) ×1.01		
Maximum Output Current	I _{OUTMAX}	V _{IN} =E-3 ^(*7)	E-4	-	-	mA	
Load Regulation	V _{OUT}	1mA ≤ I _{OUT} ≤ 100mA	-	15	50	mV	
Load Regulation 2	V _{OUT2}	1mA ≤ I _{OUT} ≤ 300mA	-	-	100	mV	
Dropout Voltage ^(*4)	V _{dif1}	I _{OUT} =30mA	E-1			mV	
	V _{dif2}	I _{OUT} =100mA	E-2			mV	
Supply Current (Type E)	I _{DD}	V _{CE} =V _{IN} =V _{OUT(T)} +1.0V	-	28	55	μA	
Supply Current (Type F)		When V _{OUT} 0.95V, V _{CE} =V _{IN} =2.0V	-	25	50		
Stand-by Current	I _{STB}	V _{IN} =V _{OUT(T)} +1.0V, V _{CE} =V _{SS} When V _{OUT} 0.95V, V _{CE} =V _{IN} =2.0V	-	0.01	0.10	μA	
Line Regulation	V _{OUT} / (V _{IN} ·V _{OUT})	V _{OUT(T)} +1.0V V _{IN} 10V When V _{OUT} 0.95V, 2.0V V _{IN} 10V I _{OUT} =30mA V _{OUT} 1.75V, I _{OUT} =10mA	-	0.01	0.20	%/V	
Input Voltage	V _{IN}	-	2	-	10	V	-
Output Voltage Temperature Characteristics	V _{OUT} / (Topr·V _{OUT})	I _{OUT} =30mA -40 ≤ Topr ≤ 85	-	100	-	ppm/	
Power Supply Rejection Ratio	PSRR	V _{IN} ={V _{OUT(T)} +1.0}V+1.0Vp-p _{AC} , When V _{OUT} ≤ 1.5V, V _{IN} =2.5V+1.0Vp-p _{AC} , I _{OUT} =50mA, f=10kHz	-	70	-	dB	
Current Limit	I _{lim}	V _{IN} =V _{OUT(T)} +1.0V, V _{CE} =V _{IN} , When V _{OUT} ≤ 1.75V, V _{IN} =V _{OUT(T)} +2.0V	-	380	-	mA	
Short Current	I _{SHORT}	V _{IN} =V _{OUT(T)} +1.0V, V _{CE} =V _{IN} , When V _{OUT} < 1.75V, V _{IN} =V _{OUT(T)} +2.0V	-	50	-	mA	
CE "H" Level Voltage	V _{CEH}	-	1.6	-	V _{IN}	V	
CE "L" Level Voltage	V _{CEL}	-	-	-	0.25	V	
CE "H" Level Current (Type E)	I _{CEH}	V _{IN} =V _{CE} =V _{OUT(T)} +1.0V When V _{OUT} 0.95V, V _{IN} =V _{CE} =2.0V	0.8	-	5.0	μA	
CE "H" Level Current (Type F)			-0.1	-	0.1		
CE "L" Level Current	I _{CEL}	V _{IN} =V _{OUT(T)} +1.0V, V _{CE} =V _{SS} When V _{OUT} 0.95V, V _{IN} =2.0V	-0.1	-	0.1	μA	

*1: Unless otherwise stated, V_{IN}=V_{OUT(T)}+1.0V. If V_{OUT} is less than 0.95V, V_{IN}= 2.0V.

*2: V_{OUT(T)} is Nominal output voltage

*3: V_{OUT(E)} is Effective output voltage

(I.e. the output voltage when "V_{OUT(T)}+1.0V" is provided at the V_{IN} pin while maintaining a certain I_{OUT} value).

*4: V_{dif}={V_{IN1}-V_{OUT1}}

V_{OUT1} is the voltage equal to 98% of the output voltage whenever an amply stabilized V_{OUT(T)}+1.0V is input for every I_{OUT}.

V_{IN1} is the input voltage when V_{OUT1} appears while input voltage is gradually decreased.

*5: If V_{OUT(T)} is less than 1.45V, V_{OUT(T)}-30mV (MIN.), V_{OUT(T)} + 30mV (MAX.)

*6: Only for the V_{OUT(T)} is more than 3.0V products.

*7: Please refer to the "Dropout Voltage" table.

ELECTRICAL CHARACTERISTICS (Continued)

XC6209 (Type G, H)

Ta=25

PARAMETER	SYMBOL	CONDITIONS	MIN.	TYP.	MAX.	UNITS	CIRCUIT
Output Voltage ⁽⁵⁾ (2%)	V _{OUT(E)} ⁽³⁾	I _{OUT} =30mA	V _{OUT(T)} ⁽²⁾ ×0.98	V _{OUT(T)} ⁽²⁾	V _{OUT(T)} ⁽²⁾ ×1.02	V	
Output Voltage ⁽⁶⁾ (1%)			V _{OUT(T)} ⁽²⁾ ×0.99		V _{OUT(T)} ⁽²⁾ ×1.01		
Maximum Output Current	I _{OUTMAX}	V _{IN} =E-3 ⁽⁷⁾	E-4	-	-	mA	
Load Regulation	ΔV _{OUT}	1mA I _{OUT} 100mA	-	15	50	mV	
Load Regulation 2	ΔV _{OUT2}	1mA I _{OUT} 300mA	-	-	100	mV	
Dropout Voltage ⁽⁴⁾	Vdif1	I _{OUT} =30mA	-	E-1		mV	
	Vdif2	I _{OUT} =100mA	-	E-2			
Supply Current (Type G)	I _{DD}	V _{IN} =V _{OUT(T)} +1.0V	-	28	55	μA	
Supply Current (Type H)		When V _{OUT} 0.95V, V _{IN} =2.0V, V _{CE} =V _{SS}	-	25	50		
Stand-by Current	I _{STB}	V _{IN} =V _{OUT(T)} +1.0V, V _{CE} =V _{IN} When V _{OUT} 0.95V, V _{CE} =V _{IN} =2.0V	-	0.01	0.10	μA	
Line Regulation	ΔV _{OUT} / (ΔV _{IN} · V _{OUT})	V _{OUT(T)} +1.0V V _{IN} 10V When V _{OUT} 0.95V, 2.0V V _{IN} 10V I _{OUT} =30mA When V _{OUT} 1.75V, I _{OUT} =10mA	-	0.01	0.20	%/V	
Input Voltage	V _{IN}	-	2	-	10	V	-
Output Voltage Temperature Characteristics	ΔV _{OUT} / (ΔT _{opr} · V _{OUT})	I _{OUT} =30mA -40 T _{opr} 85	-	±100	-	ppm/	
Power Supply Rejection Ratio	PSRR	V _{IN} =[V _{OUT(T)} +1.0]V+1.0Vp-p _{AC} When V _{OUT} 1.5V, V _{IN} =2.5V+1.0Vp-p _{AC} I _{OUT} =50mA, f=10kHz	-	70	-	dB	
Current Limit	I _{lim}	V _{IN} =V _{OUT(T)} +1.0V, V _{CE} =V _{SS} When V _{OUT} 1.75V, V _{IN} =V _{OUT(T)} +2.0V	-	380	-	mA	
Short Current	I _{SHORT}	V _{IN} =V _{OUT(T)} +1.0V, V _{OUT} =V _{SS} When V _{OUT} 1.75V, V _{IN} =V _{OUT(T)} +2.0V	-	50	-	mA	
CE "H" Level Voltage	V _{CEH}	-	1.6	-	V _{IN}	V	
CE "L" Level Voltage	V _{CEL}	-	-	-	0.25	V	
CE "H" Level Current	I _{CEH}	V _{CE} =V _{IN} =V _{OUT(T)} +1.0V When V _{OUT} 0.95V, V _{CE} =V _{IN} =2.0V	-0.1	-	0.1	μA	
CE "L" Level Current (Type G)	I _{CEL}	V _{IN} =V _{OUT(T)} +1.0V, V _{CE} =V _{SS}	-5.0	-	-0.8	μA	
CE "L" Level Current (Type H)		When V _{OUT} 0.95V, V _{IN} =2.0V	-0.1	-	0.1		

*1: Unless otherwise stated, V_{IN}=V_{OUT(T)}+1.0V. If V_{OUT} is less than 0.95V, V_{IN}= 2.0V.

*2: V_{OUT(T)} is Nominal output voltage

*3: V_{OUT(E)} is Effective output voltage

(I.e. the output voltage when "V_{OUT(T)}+1.0V" is provided at the V_{IN} pin while maintaining a certain I_{OUT} value).

*4: Vdif={V_{IN1}-V_{OUT1}}

V_{OUT1} is the voltage equal to 98% of the output voltage whenever an amply stabilized V_{OUT(T)}+1.0V is input for every I_{OUT}.

V_{IN1} is the input voltage when V_{OUT1} appears while input voltage is gradually decreased.

*5: If V_{OUT(T)} is less than 1.45V, V_{OUT(T)}-30mV (MIN.), V_{OUT(T)} + 30mV (MAX.)

*6: Only for the V_{OUT(T)} is more than 3.0V products.

*7: Please refer to the "Dropout Voltage" table.

ELECTRICAL CHARACTERISTICS (Continued)

Dropout Voltage

Voltage Accuracy 2% products

Ta=25

SYMBOL PARAMETER NOMINAL OUTPUT VOLTAGE	E-0		E-1		E-2	
	OUTPUT VOLTAGE (V) (2%)		DROPOUT VOLTAGE 1 (mV) (I _{OUT} =30mA)		DROPOUT VOLTAGE 2 (mV) (I _{OUT} =100mA)	
	V _{OUT}		Vdif1		Vdif2	
V _{OUT(T)}	MIN.	MAX.	TYP.	MAX.	TYP.	MAX.
0.90 *	0.870	0.930	1100	1110	1150	1200
0.95 *	0.920	0.980				
1.00 *	0.970	1.030	1000	1010	1050	1100
1.05 *	1.020	1.080				
1.10 *	1.070	1.130	900	910	950	1000
1.15 *	1.120	1.180				
1.20 *	1.170	1.230	800	810	850	900
1.25 *	1.220	1.280				
1.30 *	1.270	1.330	700	710	750	800
1.35 *	1.320	1.380				
1.40 *	1.370	1.430	600	610	650	700
1.45 *	1.420	1.480				
1.50 *	1.470	1.530	500	510	550	600
1.55 *	1.519	1.581				
1.60 *	1.568	1.632	400	410	500	550
1.65 *	1.617	1.683				
1.70 *	1.666	1.734	300	310	400	450
1.75 *	1.715	1.785				
1.80 *	1.764	1.836	200	210	300	400
1.85 *	1.813	1.887				
1.90 *	1.862	1.938	120	150	280	380
1.95 *	1.911	1.989				
2.00	1.960	2.040	80	120	240	350
2.05	2.009	2.091				330
2.10	2.058	2.142				
2.15	2.107	2.193				
2.20	2.156	2.244				
2.25	2.205	2.295				
2.30	2.254	2.346				
2.35	2.303	2.397				
2.40	2.352	2.448				
2.45	2.401	2.499				
2.50	2.450	2.550	70	100	220	290
2.55	2.499	2.601				270
2.60	2.548	2.652				
2.65	2.597	2.703				
2.70	2.646	2.754				
2.75	2.695	2.805				
2.80	2.744	2.856				
2.85	2.793	2.907				
2.90	2.842	2.958				
2.95	2.891	3.009				
3.00	2.940	3.060	60	90	200	250
3.05	2.989	3.111				
3.10	3.038	3.162				
3.15	3.087	3.213				
3.20	3.136	3.264				
3.25	3.185	3.315				
3.30	3.234	3.366				
3.35	3.283	3.417				
3.40	3.332	3.468				
3.45	3.381	3.519				
3.50	3.430	3.570				
3.55	3.479	3.621				

* The input voltage 2.0V (MIN.) is needed to operate the IC. 2.0V-V_{OUT(T)} of dropout voltage is needed at minimum.

ELECTRICAL CHARACTERISTICS (Continued)

Dropout Voltage (Continued)

Voltage Accuracy 2% products

Ta=25

SYMBOL	E-0		E-1		E-2	
PARAMETER NOMINAL OUTPUT VOLTAGE	OUTPUT VOLTAGE (V) (2%)		DROPOUT VOLTAGE 1 (mV) (I _{OUT} =30mA)		DROPOUT VOLTAGE 2 (mV) (I _{OUT} =100mA)	
	V _{OUT}		V _{dif1}		V _{dif2}	
V _{OUT(T)}	MIN.	MAX.	TYP.	MAX.	TYP.	MAX.
3.60	3.528	3.672	60	90	200	250
3.65	3.577	3.723				
3.70	3.626	3.774				
3.75	3.675	3.825				
3.80	3.724	3.876				
3.85	3.773	3.927				
3.90	3.822	3.978				
3.95	3.871	4.029				
4.00	3.920	4.080				
4.05	3.969	4.131				
4.10	4.018	4.182				
4.15	4.067	4.233				
4.20	4.116	4.284				
4.25	4.165	4.335				
4.30	4.214	4.386				
4.35	4.263	4.437				
4.40	4.312	4.488				
4.45	4.361	4.539				
4.50	4.410	4.590				
4.55	4.459	4.641				
4.60	4.508	4.692				
4.65	4.557	4.743				
4.70	4.606	4.794				
4.75	4.655	4.845				
4.80	4.704	4.896				
4.85	4.753	4.947				
4.90	4.802	4.998				
4.95	4.851	5.049				
5.00	4.900	5.100				
5.05	4.949	5.151				
5.10	4.998	5.202				
5.15	5.047	5.253				
5.20	5.096	5.304				
5.25	5.145	5.355				
5.30	5.194	5.406				
5.35	5.243	5.457				
5.40	5.292	5.508				
5.45	5.341	5.559				
5.50	5.390	5.610				
5.55	5.439	5.661				
5.60	5.488	5.712				
5.65	5.537	5.763				
5.70	5.586	5.814				
5.75	5.635	5.865				
5.80	5.684	5.916				
5.85	5.733	5.967				
5.90	5.782	6.018				
5.95	5.831	6.069				
6.00	5.880	6.120				
			50	70	160	210

ELECTRICAL CHARACTERISTICS (Continued)

Output Voltage

Voltage Accuracy 1% products

SYMBOL NOMINAL OUTPUT VOLTAGE	E-0	
	OUTPUT VOLTAGE (V) (1%)	
	V _{OUT}	
V _{OUT(T)}	MIN.	MAX.
3.00	2.970	3.030
3.05	3.020	3.081
3.10	3.069	3.131
3.15	3.119	3.182
3.20	3.168	3.232
3.25	3.218	3.283
3.30	3.267	3.333
3.35	3.317	3.384
3.40	3.366	3.434
3.45	3.416	3.485
3.50	3.465	3.535
3.55	3.515	3.586
3.60	3.564	3.636
3.65	3.614	3.687
3.70	3.663	3.737
3.75	3.713	3.788
3.80	3.762	3.838
3.85	3.812	3.889
3.90	3.861	3.939
3.95	3.911	3.990
4.00	3.960	4.040
4.05	4.010	4.091
4.10	4.059	4.141
4.15	4.109	4.192
4.20	4.158	4.242
4.25	4.208	4.293
4.30	4.257	4.343
4.35	4.307	4.394
4.40	4.356	4.444
4.45	4.405	4.494
4.50	4.455	4.545

SYMBOL NOMINAL OUTPUT VOLTAGE	E-0	
	OUTPUT VOLTAGE (V) (1%)	
	V _{OUT}	
V _{OUT(T)}	MIN.	MAX.
4.55	4.505	4.596
4.60	4.554	4.646
4.65	4.604	4.697
4.70	4.653	4.747
4.75	4.703	4.798
4.80	4.752	4.848
4.85	4.802	4.899
4.90	4.851	4.949
4.95	4.901	5.000
5.00	4.950	5.050
5.05	4.000	5.101
5.10	4.049	5.151
5.15	4.099	5.202
5.20	4.148	5.252
5.25	5.198	5.303
5.30	5.247	5.353
5.35	5.297	5.404
5.40	5.346	5.454
5.45	5.396	5.505
5.50	5.445	5.555
5.55	5.495	5.606
5.60	5.544	5.656
5.65	5.594	5.707
5.70	5.643	5.757
5.75	5.693	5.808
5.80	5.742	5.858
5.85	5.792	5.909
5.90	5.841	5.959
5.95	5.891	6.010
6.00	5.940	6.060

Conditions

SYMBOL CONDITIONS, SPEC. NOMINAL OUTPUT VOLTAGE (V)	E-3	E-4
	INPUT VOLTAGE (V)	MAXIMUM OUTPUT CURRENT (mA)
	V _{IN}	MIN.
0.90 ~ 0.95	2.5	260
1.00 ~ 1.05	2.5	260
1.10 ~ 1.15	2.6	270
1.20 ~ 1.25	2.7	290
1.30 ~ 1.35	2.8	300
1.40 ~ 1.45	2.9	
1.50 ~ 1.95	3.0	
2.00 ~ 6.00	V _{OUT(T)} + 1.0	

* V_{OUT(T)} is Nominal output voltage value.

OPERATIONAL EXPLANATION



Output voltage control with the XC6209 series:

The voltage divided by resistors R1 & R2 is compared with the internal reference voltage by the error amplifier.

The P-channel MOSFET, which is connected to the VOUT pin, is then driven by the subsequent output signal. The output voltage at the VOUT pin is controlled & stabilized by a system of negative feedback.

The current limit circuit and short protect circuit operate in relation to the level of output current. Further, the IC's internal circuitry can be shutdown via the CE pin's signal.

<Low ESR Capacitors>

With the XC6209 series, a stable output voltage is achievable even if used with low ESR capacitors as a phase compensation circuit is built-in. In order to ensure the effectiveness of the phase compensation, we suggest that an output capacitor (C_L) is connected as close as possible to the output pin (VOUT) and the VSS pin. Please use an output capacitor with a capacitance value of at least $1 \mu\text{F}$. Also, please connect an input capacitor (C_{IN}) of $0.1 \mu\text{F}$ between the VIN pin and the VSS pin in order to ensure a stable power input.

Stable phase compensation may not be ensured if the capacitor runs out capacitance when depending on bias and temperature. In case the capacitor depends on the bias and temperature, please make sure the capacitor can ensure the actual capacitance.

<Current Limiter, Short-Circuit Protection>

The XC6209 series includes a combination of a fixed current limiter circuit & a foldback circuit, which aid the operations of the current limiter and circuit protection. When the load current reaches the current limit level, the fixed current limiter circuit operates and output voltage drops. As a result of this drop in output voltage, the foldback circuit operates, output voltage drops further and output current decreases. When the output pin is shorted, a current of about 50mA flows.

<CE Pin>

The IC's internal circuitry can be shutdown via the signal from the CE pin with the XC6209 series. In shutdown mode, output at the VOUT pin will be pulled down to the VSS level via R1 & R2. The operational logic of the IC's CE pin is selectable (please refer to the selection guide). Note that as the standard XC6209B type is 'Active High /No Pull Down', operations will become unstable with the CE pin open. Although the CE pin is equal to an inverter input with CMOS hysteresis, with either the pull-up or pull-down options, the CE pin input current will increase when the IC's in operation.

We suggest that you use this IC with either a VIN voltage or a VSS voltage input at the CE pin. If this IC is used with the correct specifications for the CE pin, the IC will operate normally. However, supply current may increase as a result of through current in the IC's internal circuitry

NOTES ON USE

1. For temporary, transitional voltage drop or voltage rising phenomenon, the IC is liable to malfunction should the ratings be exceeded.
2. Where wiring impedance is high, operations may become unstable due to noise and/or phase lag depending on output current. Please strengthen V_{IN} and V_{SS} wiring in particular.
3. Please wire the input capacitor (C_{IN}) and the output capacitor (C_L) as close to the IC as possible.
4. The IC is controlled with constant current start-up. Start-up sequence control is requested to draw a load current after even nominal output voltage rising up the output voltage.
5. Torex places an importance on improving our products and their reliability.
We request that users incorporate fail-safe designs and post-aging protection treatment when using Torex products in their systems.

TEST CIRCUITS

Circuit



Circuit

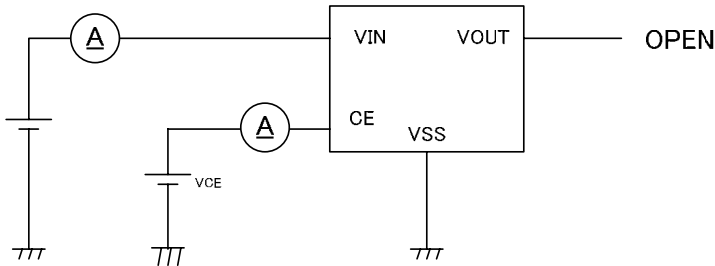

Circuit



Circuit



* Each Test Circuit, V_{CE} (CE pin Voltage)

Active

XC6209, Type A, B, E, F: $V_{CE} = V_{IN}$

XC6209, Type C, D, G, H: $V_{CE} = V_{SS}$

Stand-by

XC6209, Type A, B, E, F: $V_{CE} = V_{SS}$

XC6209, Type C, D, G, H: $V_{CE} = V_{IN}$

TYPICAL PERFORMANCE CHARACTERISTICS

(1) Output Voltage vs. Output Current

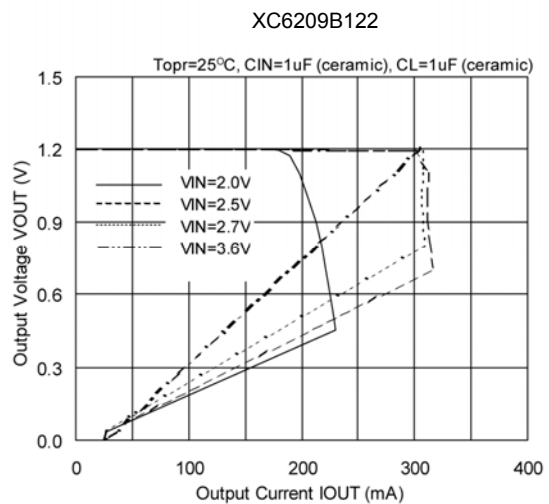

TYPICAL PERFORMANCE CHARACTERISTICS (Continued)

(1) Output Voltage vs. Output Current (Continued)

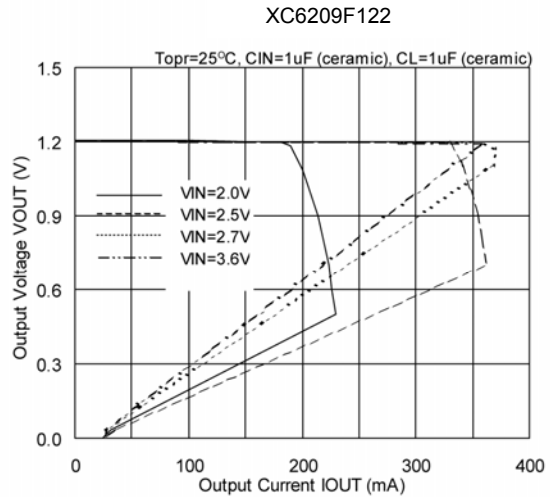
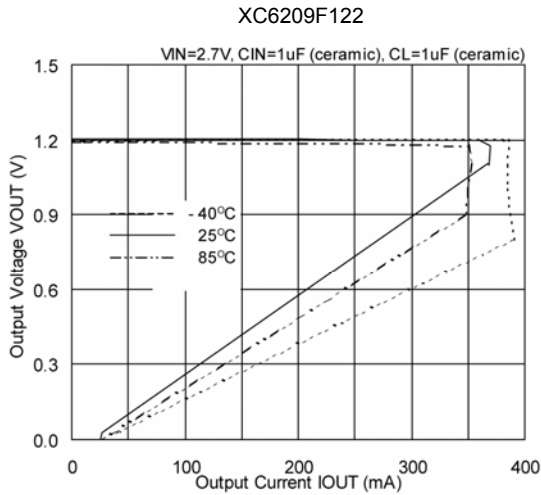

(2) Output Voltage vs. Input Voltage

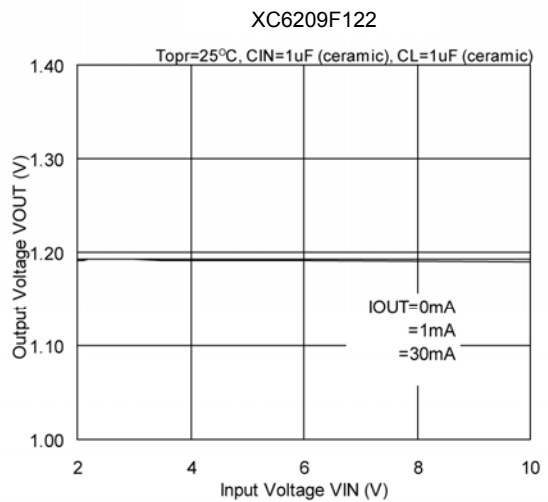
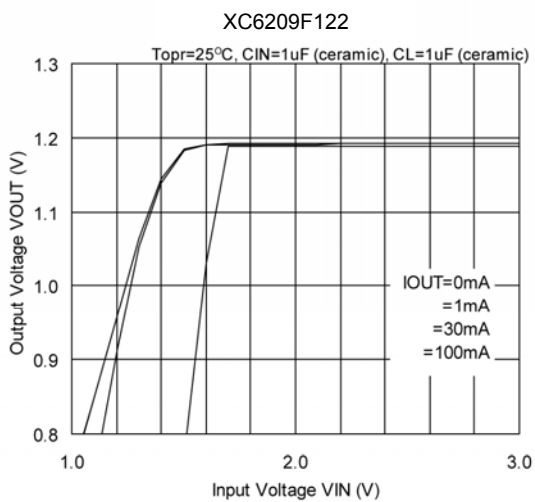
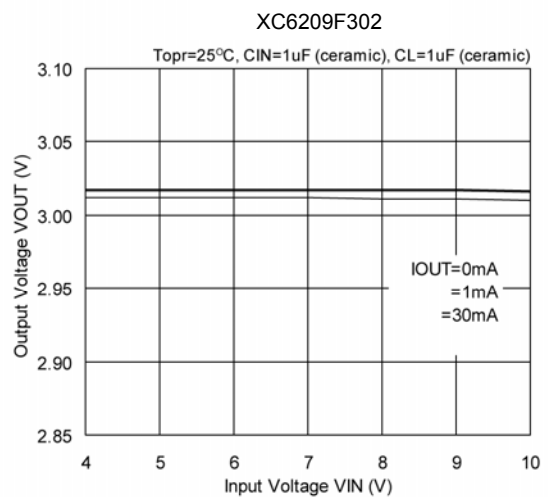
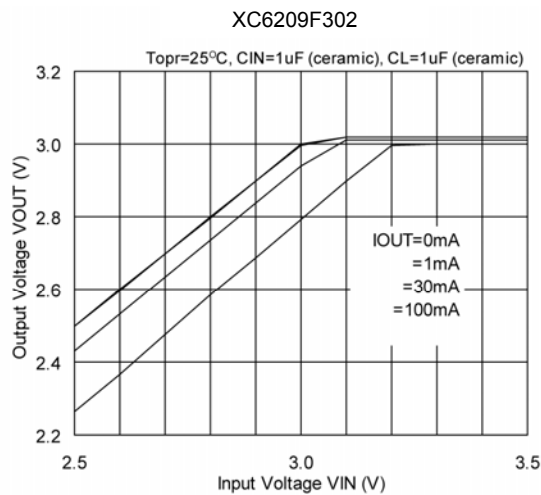

TYPICAL PERFORMANCE CHARACTERISTICS (Continued)

(3) Dropout Voltage vs. Output Current



(4) Supply Current vs. Input Voltage

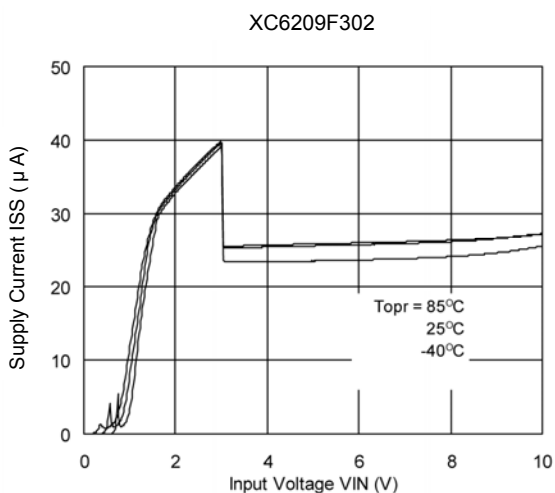

TYPICAL PERFORMANCE CHARACTERISTICS (Continued)

(5) Output Voltage vs. Ambient Temperature

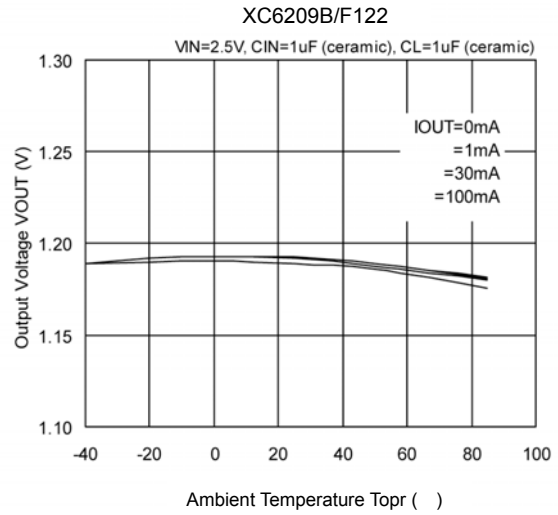
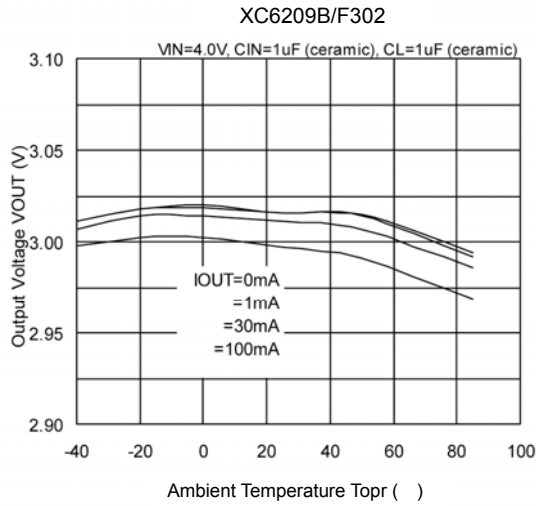

(6) Supply Current vs. Ambient Temperature

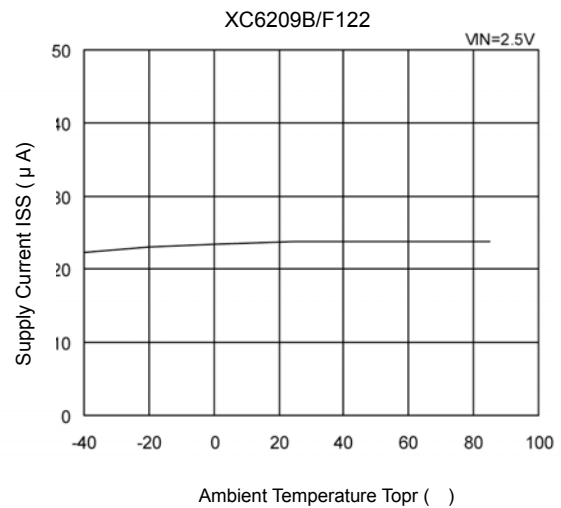
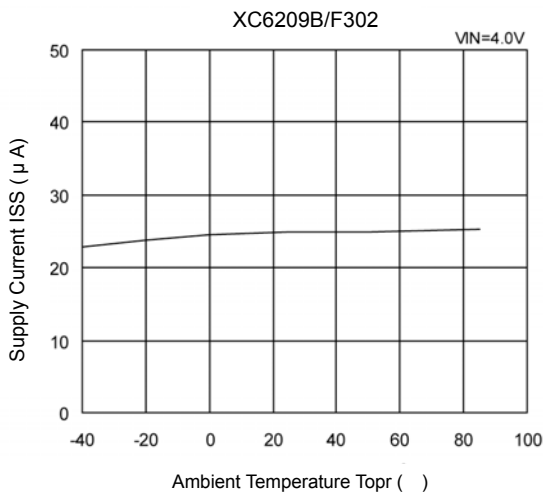

(7) P-ch Driver Transistor Characteristics



TYPICAL PERFORMANCE CHARACTERISTICS (Continued)

(8) Input Transient Response

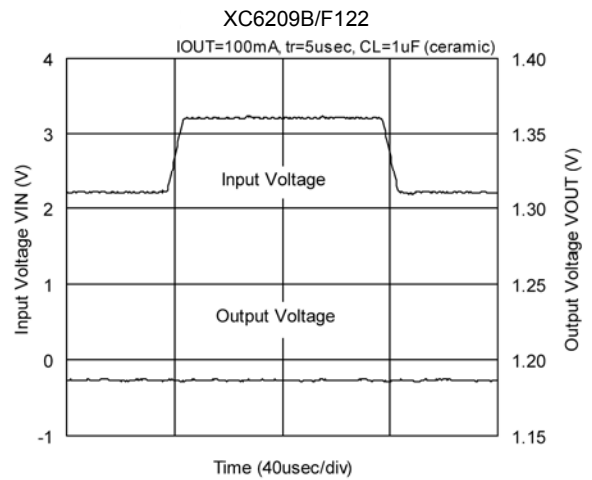
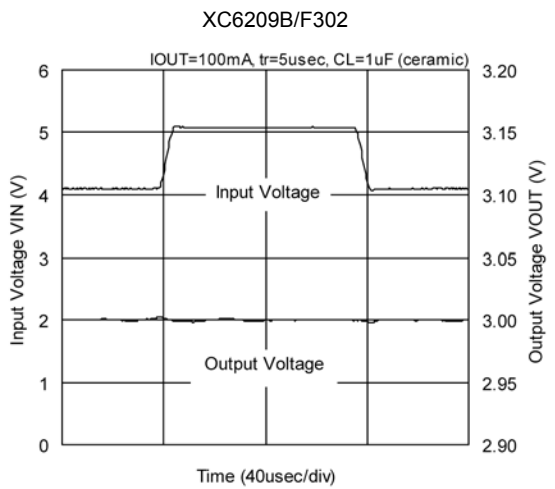

TYPICAL PERFORMANCE CHARACTERISTICS (Continued)

(9) Load Transient Response

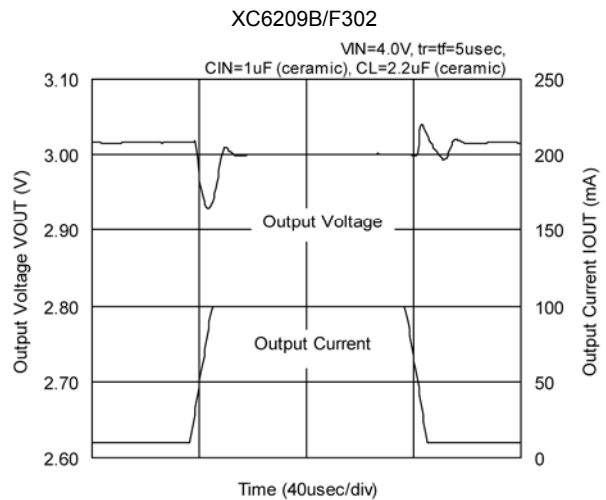
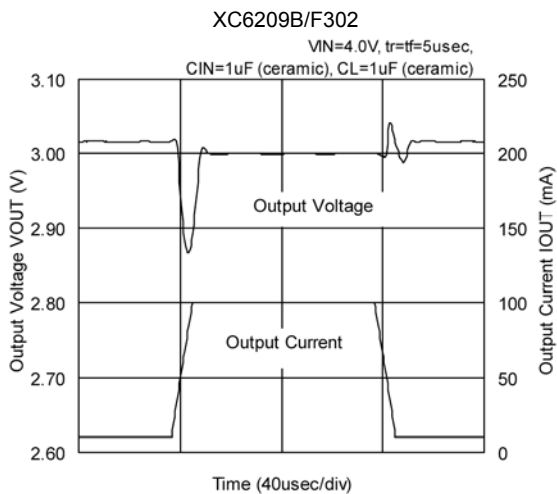
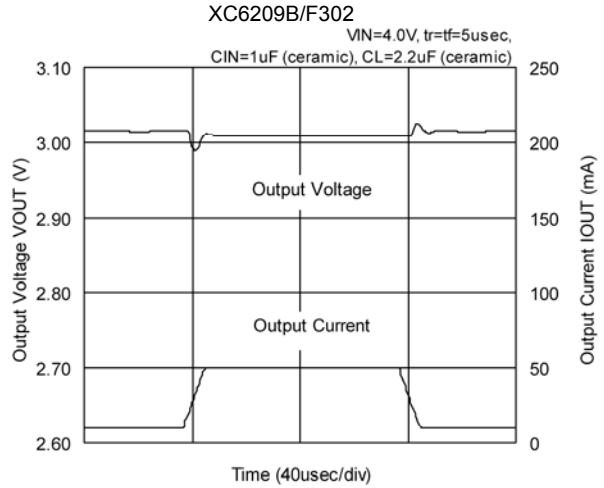

TYPICAL PERFORMANCE CHARACTERISTICS (Continued)

(9) Load Transient Response (Continued)

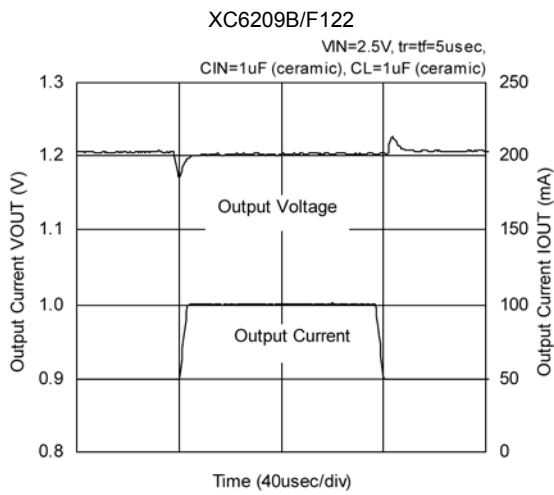

TYPICAL PERFORMANCE CHARACTERISTICS (Continued)

(10) Ripple Rejection Rate

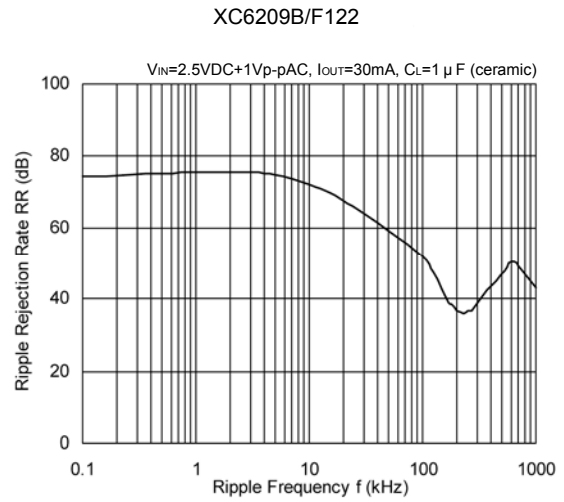

PACKAGING INFORMATION

SOT-25 (unit:mm)



SOT-89-5 (unit:mm)

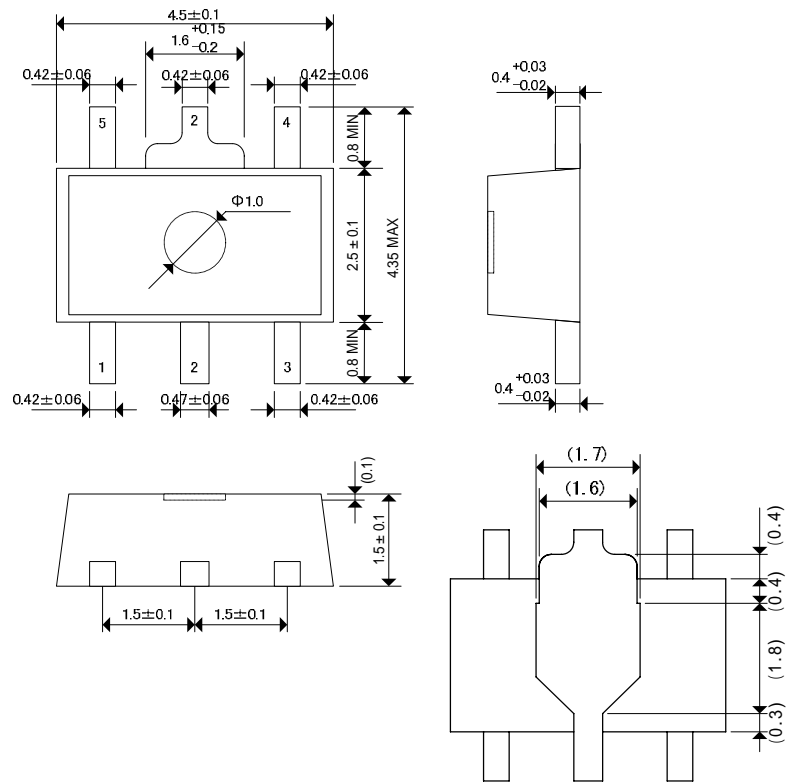

USP-6B (unit:mm)

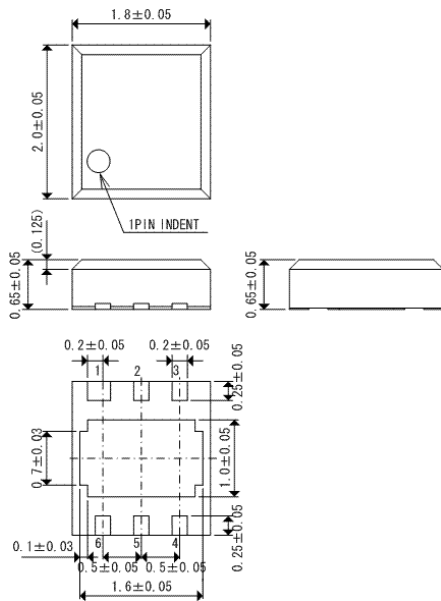

PACKAGING INFORMATION (Continued)

USP-6B Reference Pattern Layout (unit:mm)

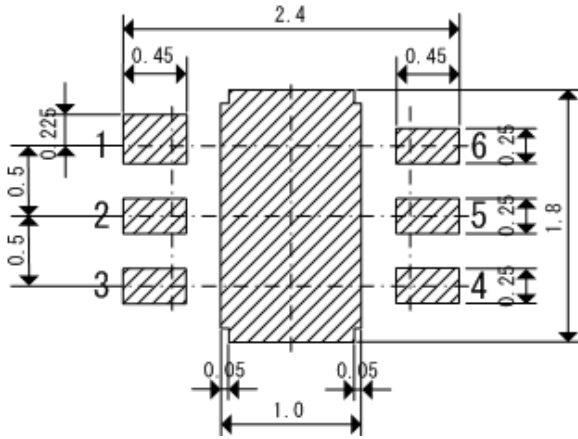

USP-6B Reference Metal Mask Design (unit:mm)

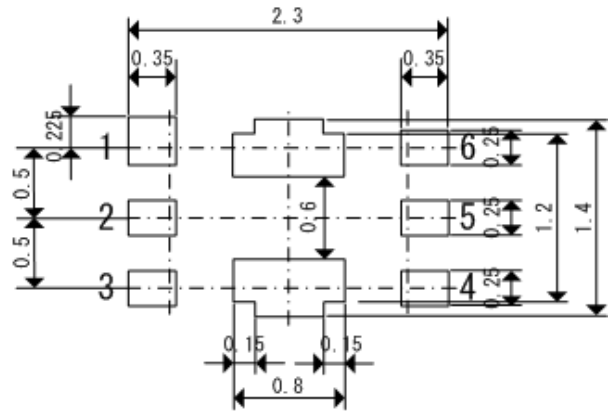

SOT-25 Power Dissipation

Power dissipation data for the SOT-25 is shown in this page.
The value of power dissipation varies with the mount board conditions.
Please use this data as the reference data taken in the following condition.

1. Measurement Condition

Condition: Mount on a board
 Ambient: Natural convection
 Soldering: Lead (Pb) free
 Board: Dimensions 40×40mm (1600mm² in one side)
 Copper (Cu) traces occupy 50% of the board area
 In top and back faces
 Package heat-sink is tied to the copper traces
 (Board of SOT-26 is used)
 Material: Glass Epoxy (FR-4)
 Thickness: 1.6mm
 Through-hole: 4 x 0.8 Diameter



Evaluation Board (unit: mm)

2. Power Dissipation vs. Ambient Temperature

Board Mount (T_{jmax}=125 °C)

Ambient Temperature (°C)	Power Dissipation Pd (mW)	Thermal Resistance (°C/W)
25	600	166.67
85	240	



SOT-89-5 Power Dissipation

Power dissipation data for the SOT-89-5 is shown in this page.
 The value of power dissipation varies with the mount board conditions.
 Please use this data as the reference data taken in the following condition.

1. Measurement Condition

- Condition: Mount on a board
- Ambient: Natural convection
- Soldering: Lead (Pb) free
- Board: Dimensions 40 x 40 mm (1600 mm² in one side)
 Copper (Cu) traces occupy 50% of the board area
 In top and back faces
 Package heat-sink is tied to the copper traces
- Material: Glass Epoxy (FR-4)
- Thickness: 1.6 mm
- Through-hole: 5 x 0.8 Diameter



Evaluation Board (unit: mm)

2. Power Dissipation vs. Ambient Temperature

Board Mount (T_{jmax}=125 °C)

Ambient Temperature (°C)	Power Dissipation Pd (mW)	Thermal Resistance (°C/W)
25	1300	76.92
85	520	

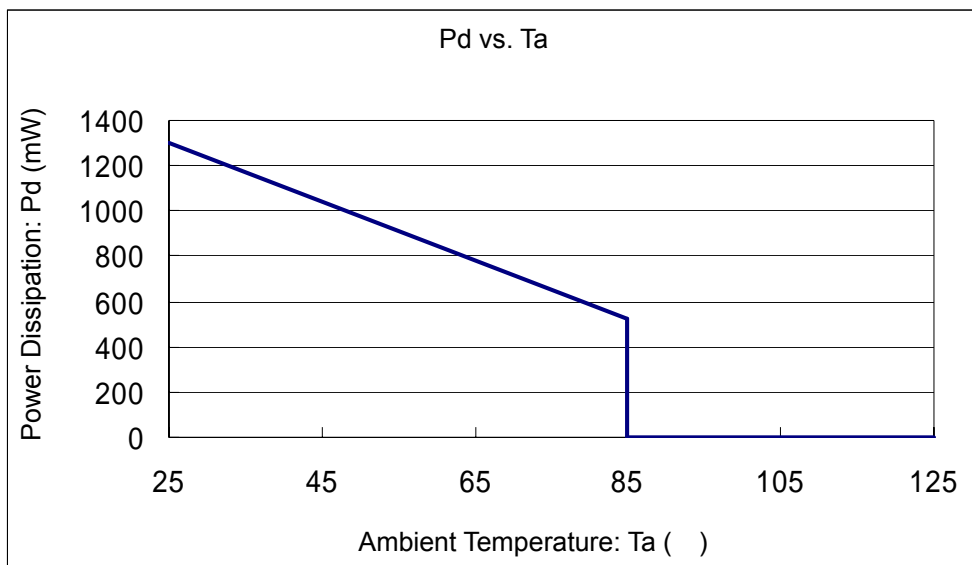

USP-6B Power Dissipation

Power dissipation data for the USP-6B is shown in this page.
The value of power dissipation varies with the mount board conditions.
Please use this data as the reference data taken in the following condition.

1. Measurement Condition

- Condition: Mount on a board
- Ambient: Natural convection
- Soldering: Lead (Pb) free
- Board: Dimensions 40×40mm (1600mm² in one side)
Copper (Cu) traces occupy 50% of the board area
In top and back faces
Package heat-sink is tied to the copper traces
- Material: Glass Epoxy (FR-4)
- Thickness: 1.6mm
- Through-hole: 4 x 0.8 Diameter



Evaluation Board (unit: mm)

2. Power Dissipation vs. Ambient Temperature

Board Mount (Tjmax=125 °C)

Ambient Temperature (°C)	Power Dissipation Pd (mW)	Thermal Resistance (°C/W)
25	1000	100.00
85	400	

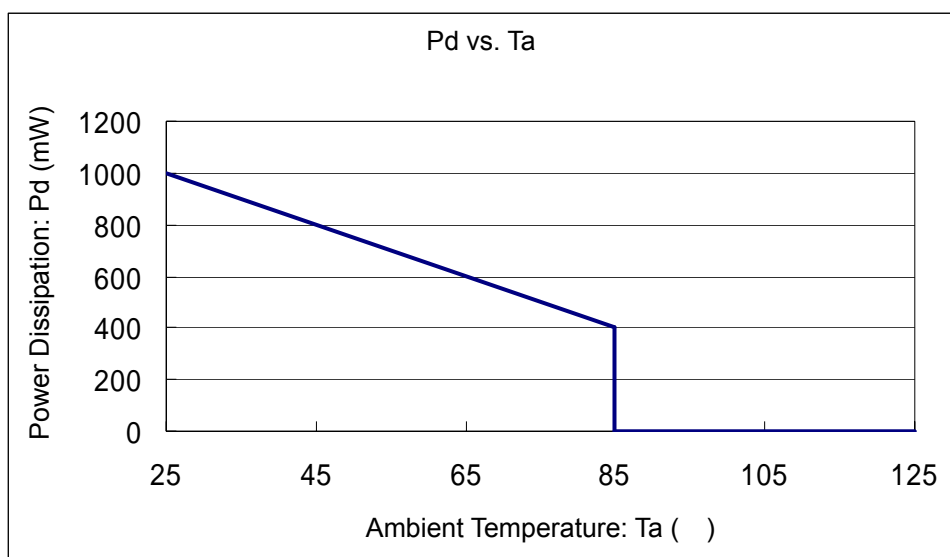

MARKING RULE

SOT-25 & SOT-89-5



SOT-25
(TOP VIEW)



SOT-89-5
(TOP VIEW)

represents product series

MARK	PRODUCT SERIES
9	XC6209xxxxxx

represents type of regulator

MARK				PRODUCT SERIES
V _{OUT} 0.1V INCREMENTS		V _{OUT} 0.05V INCREMENTS		
VOLTAGE= 0.1 ~ 3.0V	VOLTAGE= 3.1 ~ 6.0V	VOLTAGE= 0.15 ~ 3.05V	VOLTAGE= 3.15 ~ 6.05V	
V	A	E	L	XC6209Axxxxx
X	B	F	M	XC6209Bxxxxx
Y	C	H	N	XC6209Cxxxxx
Z	D	K	P	XC6209Dxxxxx
<u>V</u>	<u>A</u>	<u>E</u>	<u>L</u>	XC6209Exxxxx
<u>X</u>	<u>B</u>	<u>F</u>	<u>M</u>	XC6209Fxxxxx
<u>Y</u>	<u>C</u>	<u>H</u>	<u>N</u>	XC6209Gxxxxx
<u>Z</u>	<u>D</u>	<u>K</u>	<u>P</u>	XC6209Hxxxxx

represents integer of the output voltage

MARK	OUTPUT VOLTAGE (V)				MARK	OUTPUT VOLTAGE (V)			
0	-	3.1	-	3.15	F	1.6	4.6	1.65	4.65
1	-	3.2	-	3.25	H	1.7	4.7	1.75	4.75
2	-	3.3	-	3.35	K	1.8	4.8	1.85	4.85
3	-	3.4	-	3.45	L	1.9	4.9	1.95	4.95
4	-	3.5	-	3.55	M	2.0	5.0	2.05	5.05
5	-	3.6	-	3.65	N	2.1	5.1	2.15	5.15
6	-	3.7	-	3.75	P	2.2	5.2	2.25	5.25
7	-	3.8	-	3.85	R	2.3	5.3	2.35	5.35
8	0.9	3.9	0.95	3.95	S	2.4	5.4	2.45	5.45
9	1.0	4.0	1.05	4.05	T	2.5	5.5	2.55	5.55
A	1.1	4.1	1.15	4.15	U	2.6	5.6	2.65	5.65
B	1.2	4.2	1.25	4.25	V	2.7	5.7	2.75	5.75
C	1.3	4.3	1.35	4.35	X	2.8	5.8	2.85	5.85
D	1.4	4.4	1.45	4.45	Y	2.9	5.9	2.95	5.95
E	1.5	4.5	1.55	4.55	Z	3.0	6.0	3.05	-

represents production lot number

0 to 9, A to Z reversed character of 0 to 9 and A to Z repeated
(G, I, J, O, Q, W excluded)

MARKING RULE (Continued)

USP-6B

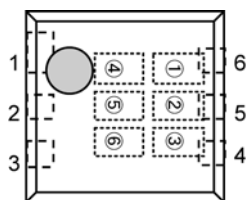

USP-6B
(TOP VIEW)

, represents product series

MARK		PRODUCT SERIES
0	9	

represents type of regulator

MARK	TYPE	PRODUCT SERIES
A	CE pin, Active High pull-down resistor built in	XC6209AxxxDx
B	CE pin, Active High no pull-down resistor built in	XC6209BxxxDx
C	CE pin, Active Low pull-up resistor built in	XC6209CxxxDx
D	CE pin, Active Low no pull-up resistor built in	XC6209DxxxDx

represents integer of output voltage

MARK	VOLTAGE (V)	PRODUCT SERIES
3	3.X	XC6209x3xxDx
5	5.X	XC6209x5xxDx

represents decimal number of output voltage

MARK	VOLTAGE (V)	PRODUCT SERIES	MARK	VOLTAGE (V)	PRODUCT SERIES
0	X.0	XC6209xx0xDx	A	X.05	XC6209xx0ADx
1	X.1	XC6209xx1xDx	B	X.15	XC6209xx1ADx
2	X.2	XC6209xx2xDx	C	X.25	XC6209xx2ADx
3	X.3	XC6209xx3xDx	D	X.35	XC6209xx3ADx
4	X.4	XC6209xx4xDx	E	X.45	XC6209xx4ADx
5	X.5	XC6209xx5xDx	F	X.55	XC6209xx5ADx
6	X.6	XC6209xx6xDx	H	X.65	XC6209xx6ADx
7	X.7	XC6209xx7xDx	K	X.75	XC6209xx7ADx
8	X.8	XC6209xx8xDx	L	X.85	XC6209xx8ADx
9	X.9	XC6209xx9xDx	M	X.95	XC6209xx9ADx

Represents production lot number

0 to 9, A to Z repeated (G, I, J, O, Q, W excluded)

Note: No character inversion used.