

## High Current, High Speed LDO Regulators

### ■ GENERAL DESCRIPTION

The XC6210 series are precise, low noise, high current, positive voltage low dropout regulators. They are fabricated using Torex's CMOS process.

The series features a voltage reference, an error amplifier, a current limiter, and a phase compensation circuit plus a driver transistor. With a low ON resistance driver transistor built into, batteries can be used until input-output voltage differential is minimal and can accordingly be used for a longer time.

The series is also compatible with low ESR ceramic capacitors which give added output stability.

The output voltage of the LDO is selectable in 0.05V increments within the range of 0.80V to 5.00V.

The current limiter's foldback circuit also operates as the output current limiter and the output pin protection.

The IC's internal regulator circuit can be placed in stand-by mode via the CE function. In the stand-by mode, power consumption is greatly reduced.

### ■ APPLICATIONS

- Optical disk drive
- Magnetic disk drive
- Digital still cameras / Camcorders
- Digital audio equipments
- Multi-function power supplies

### ■ FEATURES

- Maximum Output Current** : More than 700mA  
(800mA limit, TYP.)  
( $1.60V \leq V_{OUT} \leq 5.00V$ )
- Dropout Voltage** : 50mV @ 100mA  
: 100mV @ 200mA
- Operating Voltage Range** : 1.50V ~ 6.00V
- Output Voltage Range** : 0.80V ~ 5.00V (0.05V increments)
- Highly Accurate** :  $\pm 2\%$  ( $1.55V \leq V_{OUT} \leq 5.00V$ )  
:  $\pm 30mV$  ( $0.80V \leq V_{OUT} \leq 1.50V$ )
- Low Power Consumption** : 35  $\mu$ A (TYP.)
- High Ripple Rejection** : 60dB @ 1kHz
- Operational Ambient Temperature** : -40°C ~ 85°C

#### CMOS

#### Low ESR Capacitor Compatible

- Packages** : SOT-25  
: SOT-89-5  
: USP-6B

**Environmentally Friendly** : EU RoHS Compliant, Pb Free

### ■ TYPICAL APPLICATION CIRCUIT



### ■ TYPICAL PERFORMANCE CHARACTERISTICS

- Dropout Voltage vs. Output Current



## ■ BLOCK DIAGRAM

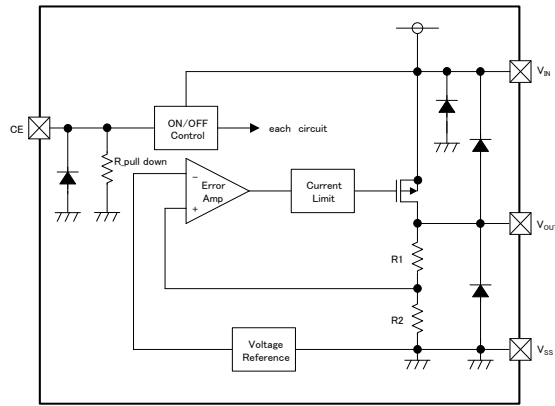

**XC6210A Series**



**XC6210B/D Series**

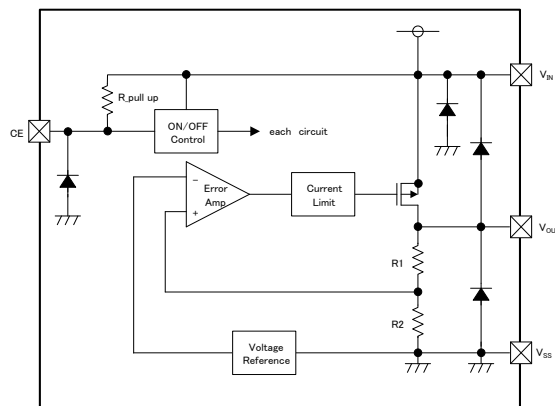

**XC6210C Series**

\*Diodes shown in the above circuit are ESD protection diodes and parasitic diodes

## ■ PRODUCT CLASSIFICATION

### ● Ordering Information

XC6210 ①②③④⑤⑥-⑦<sup>(\*)</sup>

DESIGNATOR	ITEM	SYMBOL	DESCRIPTION
①	Type	A	Refer to Selection Guide
		B	
		C	
		D	
②③	Output Voltage	08 ~ 50	e.g. 3.00V → ②=3, ③=0
④	Output Voltage Accuracy	2	Output voltage {x.x0v} (the 2nd decimal place is "0") $0.80V \leq V_{OUT(T)} \leq 1.50V : V_{OUT(T)} \pm 30mV$ $1.60V \leq V_{OUT(T)} \leq 5.00V : V_{OUT(T)} \pm 2\%$ e.g. 3.00V → ②=3, ③=0, ④=2
		A	Output voltage {x.x5v} (the 2nd decimal place is "5") $0.85V \leq V_{OUT(T)} \leq 1.45V : V_{OUT(T)} \pm 30mV$ $1.55V \leq V_{OUT(T)} \leq 4.95V : V_{OUT(T)} \pm 2\%$ e.g. 3.05V → ②=3, ③=0, ④=A
⑤⑥-⑦ <sup>(*)</sup>	Packages	MR	SOT-25 (3,000pcs/Reel)
		MR-G	SOT-25 (3,000pcs/Reel)
		PR	SOT-89-5 (1,000pcs/Reel)
		PR-G	SOT-89-5 (1,000pcs/Reel)
		DR	USP-6B (3,000pcs/Reel)
		DR-G	USP-6B (3,000pcs/Reel)

<sup>(\*)</sup> The "-G" suffix indicates that the products are Halogen and Antimony free as well as being fully EU RoHS compliant.

### ● Selection Guide

TYPE	CE High Active	CE Low Active	CE PULL-DOWN RESISTOR	CE PULL-UP RESISTOR
A	Yes	No	Yes	No
B	Yes	No	No	No
C	No	Yes	No	Yes
D	No	Yes	No	No

## PIN CONFIGURATION



SOT-25  
(TOP VIEW)

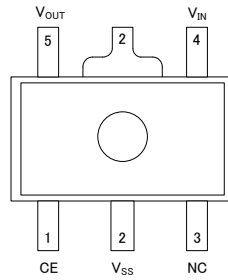

SOT-89-5  
(TOP VIEW)

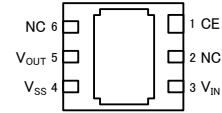

USP-6B  
(BOTTOM VIEW)

\*The dissipation pad for the USP-6B package should be solder-plated in reference mount pattern and metal masking so as to enhance mounting strength and heat release. If the pad needs to be connected to other pins, it should be connected to the Vss pins.

## PIN ASSIGNMENT

PIN NUMBER			PIN NAME	FUNCTION
SOT-25	SOT-89-5	USP-6B		
3	1	1	CE	ON/OFF Control
1	4	3	V <sub>IN</sub>	Power Input
2	2	4	V <sub>SS</sub>	Ground
5	5	5	V <sub>OUT</sub>	Output
4	3	2, 6	NC	No Connection

## ■ PIN FUNCTION ASSIGNMENT

1) XC6210 Series A Type (CE High Active, CE pull-down resistor)

PIN NAME	SIGNAL	STATUS
CE	H	Active
	L	Stand-by
	OPEN	

2) XC6210 Series B Type (CE High Active, CE no pull-down resistor)

PIN NAME	SIGNAL	STATUS
CE	H	Active
	L	Stand-by
	OPEN	Undefined state

3) XC6210 Series C Type (CE Low Active, CE pull-up resistor)

PIN NAME	SIGNAL	STATUS
CE	H	Stand-by
	L	Active
	OPEN	Stand-by

4) XC6210 Series D Type (CE Low Active, CE no pull-up resistor)

PIN NAME	SIGNAL	STATUS
CE	H	Stand-by
	L	Active
	OPEN	Undefined state

## ■ ABSOLUTE MAXIMUM RATINGS

PARAMETER	SYMBOL	RATINGS	UNITS
Input Voltage	$V_{IN}$	6.5	V
Output Current *	$I_{OUT}$	900	mA
Output Voltage	$V_{OUT}$	$V_{SS} - 0.3 \sim V_{IN} + 0.3$	V
CE Pin Voltage	$V_{CE}$	$V_{SS} - 0.3 \sim 6.5$	V
Power Dissipation ( $T_a=25^{\circ}\text{C}$ )	SOT-25	250	mW
		600 (40mm x 40mm standard board) <sup>(*)2)</sup>	
		760 (JESD51-7 board) <sup>(*)2)</sup>	
	SOT-89-5	500	
		1300 (40mm x 40mm standard board) <sup>(*)2)</sup>	
	USP-6B	1750 (JESD51-7 board) <sup>(*)2)</sup>	
		100	
1000 (40mm x 40mm standard board) <sup>(*)2)</sup>			
Operating Temperature Range	$T_{opr}$	-40 ~ 85	$^{\circ}\text{C}$
Storage Temperature Range	$T_{stg}$	-55 ~ 125	$^{\circ}\text{C}$

(\*)  $I_{OUT}=P_d / (V_{IN} - V_{OUT})$

(\*)2) The power dissipation figure shown is PCB mounted and is for reference only.  
The mounting condition is please refer to PACKAGING INFORMATION.

## ELECTRICAL CHARACTERISTICS

●XC6210 series

Ta=25°C

PARAMETER	SYMBOL	CONDITIONS	MIN.	TYP.	MAX.	UNIT	CIRCUIT
Output Voltage	V <sub>OUT(E)</sub> <sup>(*)3</sup>	V <sub>IN</sub> =V <sub>OUT(T)</sub> +1.0V, I <sub>OUT</sub> =30mA V <sub>CE</sub> =ON (V <sub>IN</sub> or V <sub>SS</sub> ) (V <sub>OUT(T)</sub> > 1.50V)	x 0.98	V <sub>OUT(T)</sub> <sup>(*)2</sup>	x 1.02	V	①
		V <sub>IN</sub> =V <sub>OUT(T)</sub> +1.0V, I <sub>OUT</sub> =30mA, V <sub>CE</sub> =ON(V <sub>IN</sub> or V <sub>SS</sub> )(V <sub>OUT(T)</sub> ≤ 1.50V)	(-30mV)	V <sub>OUT(T)</sub> <sup>(*)2</sup>	(+30mV)		
Maximum Output Current	I <sub>OUTMAX</sub>	V <sub>IN</sub> =V <sub>OUT(T)</sub> +1.0V, V <sub>CE</sub> =ON(V <sub>IN</sub> or V <sub>SS</sub> ) (V <sub>OUT(T)</sub> > 1.50V)	700	-	-	mA	①
		V <sub>IN</sub> =V <sub>OUT(T)</sub> +1.0V, V <sub>CE</sub> =ON(V <sub>IN</sub> or V <sub>SS</sub> ) (V <sub>OUT(T)</sub> ≤ 1.50V)	500	-	-		
Load Regulation	ΔV <sub>OUT</sub>	1mA≤I <sub>OUT</sub> ≤100mA, V <sub>CE</sub> =ON(V <sub>IN</sub> or V <sub>SS</sub> )	-	15	60	mV	①
Dropout Voltage	V <sub>dif1</sub> <sup>(*)4</sup>	I <sub>OUT</sub> =30mA, V <sub>CE</sub> =ON(V <sub>IN</sub> or V <sub>SS</sub> )	E-1			mV	①
	V <sub>dif2</sub> <sup>(*)4</sup>	I <sub>OUT</sub> =100mA, V <sub>CE</sub> =ON(V <sub>IN</sub> or V <sub>SS</sub> )	E-2				
Supply Current (A type)	I <sub>DD</sub>	V <sub>IN</sub> =V <sub>CE</sub> =V <sub>OUT(T)</sub> +1.0V	E-3			μA	②
Supply Current (B type)		V <sub>IN</sub> =V <sub>CE</sub> =V <sub>OUT(T)</sub> +1.0V	-	35	55		
Supply Current (C type)		V <sub>IN</sub> =V <sub>OUT(T)</sub> +1.0V, V <sub>CE</sub> =V <sub>SS</sub>	E-3				
Supply Current (D type)		V <sub>IN</sub> =V <sub>OUT(T)</sub> +1.0V, V <sub>CE</sub> =V <sub>SS</sub>	-	35	55		
Stand-by Current	I <sub>STBY</sub>	V <sub>IN</sub> =6.0V, V <sub>CE</sub> =OFF(V <sub>IN</sub> or V <sub>SS</sub> )	-0.10	-	0.10	μA	②
Line Regulation	$\frac{\Delta V_{OUT}}{\Delta V_{IN} \cdot V_{OUT}}$	V <sub>OUT(T)</sub> +1.0V≤V <sub>IN</sub> ≤6.0V V <sub>CE</sub> =ON(V <sub>IN</sub> or V <sub>SS</sub> ), I <sub>OUT</sub> =30mA V <sub>OUT(T)</sub> <4.50V	-	0.01	0.20	% / V	①
		5.5V≤V <sub>IN</sub> ≤6.0V V <sub>CE</sub> =ON(V <sub>IN</sub> or V <sub>SS</sub> ), I <sub>OUT</sub> =30mA V <sub>OUT(T)</sub> ≥4.50V					
Input Voltage	V <sub>IN</sub>	-	1.5	-	6.0	V	-
Output Voltage Temperature Characteristics	$\frac{\Delta V_{OUT}}{\Delta T_{opr} \cdot V_{OUT}}$	I <sub>OUT</sub> =30mA, V <sub>CE</sub> =ON (V <sub>IN</sub> or V <sub>SS</sub> ) -40°C≤T <sub>opr</sub> ≤85°C	-	±100	-	ppm/ °C	①
Ripple Rejection Rate	PSRR	V <sub>IN</sub> =[V <sub>OUT(T)</sub> +1.0]V <sub>DC</sub> +0.5V <sub>P-PAC</sub> V <sub>CE</sub> =ON(V <sub>IN</sub> or V <sub>SS</sub> ), I <sub>OUT</sub> =30mA, f=1kHz V <sub>OUT(T)</sub> <4.75V	-	60	-	dB	③
		V <sub>IN</sub> =5.75V <sub>DC</sub> +0.5V <sub>P-PAC</sub> V <sub>CE</sub> =ON(V <sub>IN</sub> or V <sub>SS</sub> ), I <sub>OUT</sub> =30mA, f=1kHz V <sub>OUT(T)</sub> ≥4.75V					
Current Limiter	I <sub>LIM</sub>	V <sub>IN</sub> =V <sub>OUT(T)</sub> +1.0V, V <sub>CE</sub> =ON(V <sub>IN</sub> or V <sub>SS</sub> ) V <sub>OUT(T)</sub> >1.50V	700	800	-	mA	①
		V <sub>IN</sub> =V <sub>OUT(T)</sub> +1.0V, V <sub>CE</sub> =ON(V <sub>IN</sub> or V <sub>SS</sub> ) V <sub>OUT(T)</sub> ≤1.50V	-	800	-		
Short-Circuit Current	I <sub>SHORT</sub>	V <sub>IN</sub> =V <sub>OUT(T)</sub> +1.0V, V <sub>CE</sub> =ON(V <sub>IN</sub> or V <sub>SS</sub> )	-	50	-	mA	①
CE "H" Level Voltage	V <sub>CEH</sub>	-	1.3	-	6.0	V	①
CE "L" Level Voltage	V <sub>CEL</sub>	-	-	-	0.25		
CE "H" Level Current	I <sub>CEH</sub>	V <sub>CE</sub> =V <sub>IN</sub> =V <sub>OUT(T)</sub> +1.0V (Type A)	E-4	-	E-4	μA	①
		V <sub>CE</sub> =V <sub>IN</sub> =V <sub>OUT(T)</sub> +1.0V (Type B/C/D)	- 0.10	-	0.10		
CE "L" Level Current	I <sub>CEL</sub>	V <sub>IN</sub> =V <sub>OUT(T)</sub> +1.0V, V <sub>CE</sub> =V <sub>SS</sub> (Type C)	E-5	-	E-5	μA	①
		V <sub>IN</sub> =V <sub>OUT(T)</sub> +1.0V, V <sub>CE</sub> =V <sub>SS</sub> (Type A/B/D)	- 0.10	-	0.10		

NOTE:

\*1: Unless otherwise stated, V<sub>IN</sub>=V<sub>OUT(T)</sub>+1.0V

\*2: V<sub>OUT(T)</sub>=Specified output voltage

\*3: V<sub>OUT(E)</sub>=Effective output voltage

(i.e. the output voltage when "V<sub>OUT(T)</sub>+1.0V" is provided while maintaining a certain I<sub>OUT</sub> value).

\*4: V<sub>dif</sub>={V<sub>IN1</sub><sup>(\*)6</sup>-V<sub>OUT1</sub><sup>(\*)5</sup>}

\*5: A voltage equal to 98% of the output voltage whenever a stabilized V<sub>OUT1</sub>=I<sub>OUT</sub>{V<sub>OUT(T)</sub>+1.0V} is input.

\*6: V<sub>IN1</sub>= the input voltage when V<sub>OUT1</sub>, which appears as input voltage is gradually decreased.

\*7: V<sub>CE</sub> conditions: XC6210 Series A / B type: ON=V<sub>IN</sub>, OFF=V<sub>SS</sub>  
XC6210 Series C / D type: ON=V<sub>SS</sub>, OFF=V<sub>IN</sub>

## VOLTAGE CHART

● Dropout Voltage, Supply Current, CE "H / L" Level Current Chart

Ta=25°C

SETTING OUTPUT VOLTAGE	Output Voltage		E-1		E-2		E-3		E-4		E-5											
			Dropout Voltage (I <sub>OUT</sub> =30mA)		Dropout Voltage (I <sub>OUT</sub> =100mA)		Supply Current		CE "H" Level Current		CE "L" Level Current											
(V)	(V)		(mV)		(mV)		(μA)		(μA)		(μA)											
V <sub>OUT(T)</sub>	V <sub>OUT</sub>		V <sub>dif1</sub>		V <sub>dif2</sub>		I <sub>DD</sub>		I <sub>CEH</sub>		I <sub>CEL</sub>											
	MIN.	MAX.	TYP.	MAX.	TYP.	MAX.	TYP.	MAX.	MIN.	MAX.	MIN.	MAX.										
0.80	0.770	0.830	100.0	700.0	250.0	800.0	38.0	60.0	1.50	5.00	-5.00	-1.50										
0.85	0.820	0.880																				
0.90	0.870	0.930																				
0.95	0.920	0.980																				
1.00	0.970	1.030	50.0	500.0	150.0	600.0	38.5	61.5	2.00	6.50	-6.50	-2.00										
1.05	1.020	1.080																				
1.10	1.070	1.130																				
1.15	1.120	1.180																				
1.20	1.170	1.230	30.0	300.0	100.0	400.0	39.0	63.0	2.50	8.00	-8.00	-2.50										
1.25	1.220	1.280																				
1.30	1.270	1.330																				
1.35	1.320	1.380																				
1.40	1.370	1.430																				
1.45	1.420	1.480																				
1.50	1.470	1.530	27.0	41.0	90.0	135.0	39.5	64.5	3.00	9.50	-9.50	-3.00										
1.55	1.519	1.581																				
1.60	1.568	1.632																				
1.65	1.617	1.683																				
1.70	1.666	1.734																				
1.75	1.715	1.785																				
1.80	1.764	1.836																				
1.85	1.813	1.887																				
1.90	1.862	1.938																				
1.95	1.911	1.989																				
2.00	1.960	2.040											25.0	37.0	80.0	120.0	40.0	66.0	3.50	11.00	-11.00	-3.50
2.05	2.009	2.091																				
2.10	2.058	2.142																				
2.15	2.107	2.193																				
2.20	2.156	2.244																				
2.25	2.205	2.295																				
2.30	2.254	2.346																				
2.35	2.303	2.397																				
2.40	2.352	2.448																				
2.45	2.401	2.499																				
2.50	2.450	2.550	18.0	28.0	60.0	90.0	40.0	66.0	3.50	11.00	-11.00	-3.50										
2.55	2.499	2.601																				
2.60	2.548	2.652																				
2.65	2.597	2.703																				
2.70	2.646	2.754																				
2.75	2.695	2.805																				
2.80	2.744	2.856																				
2.85	2.793	2.907																				
2.90	2.842	2.958																				
2.95	2.891	3.009																				

## VOLTAGE CHART (Continued)

● Dropout Voltage, Supply Current, CE "H / L" Level Current Chart

Ta=25°C

SETTING OUTPUT VOLTAGE	Output Voltage		E-1		E-2		E-3		E-4		E-5	
			Dropout Voltage (I <sub>OUT</sub> =30mA)		Dropout Voltage (I <sub>OUT</sub> =100mA)		Supply Current		CE "H" Level Current		CE "L" Level Current	
(V)	(V)		(mV)		(mV)		(μA)		(μA)		(μA)	
V <sub>OUT(T)</sub>	V <sub>OUT</sub>		Vdif1		Vdif2		I <sub>DD</sub>		I <sub>CEH</sub>		I <sub>CEL</sub>	
	MIN.	MAX.	TYP.	MAX.	TYP.	MAX.	TYP.	MAX.	MIN.	MAX.	MIN.	MAX.
3.00	2.940	3.060	15.0	23.0	50.0	75.0	40.5	67.5	4.00	12.50	-12.50	-4.00
3.05	2.989	3.111										
3.10	3.038	3.162										
3.15	3.087	3.213										
3.20	3.136	3.264										
3.25	3.185	3.315										
3.30	3.234	3.366										
3.35	3.283	3.417										
3.40	3.332	3.468										
3.45	3.381	3.519										
3.50	3.430	3.570	15	23	50	75	41.0	69.0	4.40	14.00	-14.00	-4.40
3.55	3.479	3.621										
3.60	3.528	3.672										
3.65	3.577	3.723										
3.70	3.626	3.774										
3.75	3.675	3.825										
3.80	3.724	3.876										
3.85	3.773	3.927										
3.90	3.822	3.978										
3.95	3.871	4.029										
4.00	3.920	4.080	15.0	23.0	50.0	75.0	41.5	70.5	4.85	15.50	-15.50	-4.85
4.05	3.969	4.131										
4.10	4.018	4.182										
4.15	4.067	4.233										
4.20	4.116	4.284										
4.25	4.165	4.335										
4.30	4.214	4.386										
4.30	4.214	4.386										
4.40	4.312	4.488										
4.45	4.361	4.539										
4.50	4.410	4.590										
4.55	4.459	4.641										
4.60	4.508	4.692										
4.65	4.557	4.743										
4.70	4.606	4.794										
4.75	4.655	4.845										
4.80	4.704	4.896										
4.85	4.753	4.947										
4.90	4.802	4.998										
4.95	4.851	5.049										
5.00	4.900	5.100					42.0	72.0	5.30	17.00	-17.00	-5.30



## TEST CIRCUITS

● Circuit ①

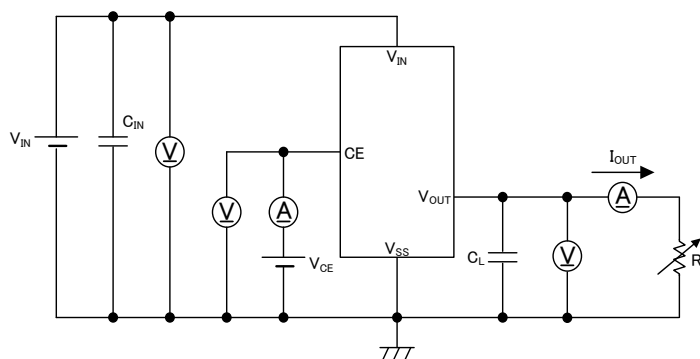

● Circuit ②



● Circuit ③



● Output Capacitor Corresponding Chart(MIN)

OUTPUT VOLTAGE	$C_L$
0.80V ~ 1.45V	More than 6.8 $\mu$ F
1.50V ~ 1.75V	More than 4.7 $\mu$ F
1.80V ~ 5.00V	More than 1.0 $\mu$ F

## OPERATIONAL EXPLANATION

### <Output Voltage Regulator Control>

The voltage, divided by resistors R1 & R2, which are connected to the V<sub>OUT</sub> pin is compared with the internal reference voltage by the error amplifier. The P-channel MOSFET, which is connected to the V<sub>OUT</sub> pin, is then driven by the subsequent output signal. The output voltage at the V<sub>OUT</sub> pin is controlled & stabilized by negative feedback. The constant current limit circuit and short circuit protection operate in relation to the level of output current.



### <Low ESR Capacitor>

With the XC6210 series regulator, a stable output voltage is achievable even if low ESR capacitors are used, as a phase compensation circuit is built into the regulator. In order to ensure the effectiveness of the phase compensation, we suggest that an output capacitor (C<sub>L</sub>) be connected as close as possible, between the output pin (V<sub>OUT</sub>) and the V<sub>SS</sub> pin. Please use an output capacitor (C<sub>L</sub>) with a capacitance, based on the chart below. We also suggest an input capacitor (C<sub>IN</sub>) of 1.0μF: this should be connected between V<sub>IN</sub> and V<sub>SS</sub> in order to stabilize input power source.

Output Capacitor Corresponding Chart(MIN)

OUTPUT VOLTAGE RANGE	OUTPUT CAPACITOR
0.80V ~ 1.45V	More than 6.8 μ F
1.50V ~ 1.75V	More than 4.7 μ F
1.80V ~ 5.00V	More than 1.0 μ F

### <Current Limiter, Short-Circuit Protection>

The XC6210 series regulator offers a combination of current limit and short circuit protection by means of a built-in fixed current limiter circuit and a foldback circuit. When the load current reaches the current limit level, the fixed current limiter circuit operates and output voltage drops. As a result of this drop in output voltage, the foldback circuit operates, the output voltage drops further and output current decreases. When the output pin is shorted, a current of about 50mA flows.

### <CE Pin>

The IC's internal regulator circuitry can be shut down via the signal from the CE pin with the XC6210 series. In shutdown mode, output at the V<sub>OUT</sub> pin will be pulled down to the V<sub>SS</sub> level via R1 & R2. Options are available for the CE pin logic (See the product classification). Note that as the XC6210 series B types are 'High Active / No Pull-Down', operations will become unstable with the CE pin open. Although the CE pin is equal to an inverter input with CMOS hysteresis, with either the pull-up or pull-down options, the CE pin input current will increase when the IC is in operation.

We suggest that you use this IC with either a V<sub>IN</sub> voltage or a V<sub>SS</sub> voltage input at the CE pin. If this IC is used with the correct specifications for the CE pin, the IC will operate normally. However, supply current may increase as a result of through current in the IC's internal circuitry if a voltage other than V<sub>IN</sub> or V<sub>SS</sub> is applied.

## ■ NOTES ON USE

1. Please use this IC within the stated maximum ratings. For temporary, transitional voltage drop or voltage rising phenomenon, the IC is liable to malfunction should the ratings be exceeded.
2. Where wiring impedance is high, operations may become unstable due to noise and/or phase lag depending on output current. Please strengthen  $V_{IN}$  and  $V_{SS}$  wiring in particular.
3. Please wire the input capacitor ( $C_{IN}$ ) and the output capacitor ( $C_L$ ) as close to the IC as possible. If rapid input fluctuation or load fluctuation should occur, please increase the capacitor value such as  $C_{IN}$  or  $C_L$  more than the recommended values to stabilize the operation.
4. Torex places an importance on improving our products and its reliability. However, by any possibility, we would request user fail-safe design and post-aging treatment on system or equipment.

## TYPICAL PERFORMANCE CHARACTERISTICS

### (1) Output Voltage vs. Output Current

XC6210x082xx

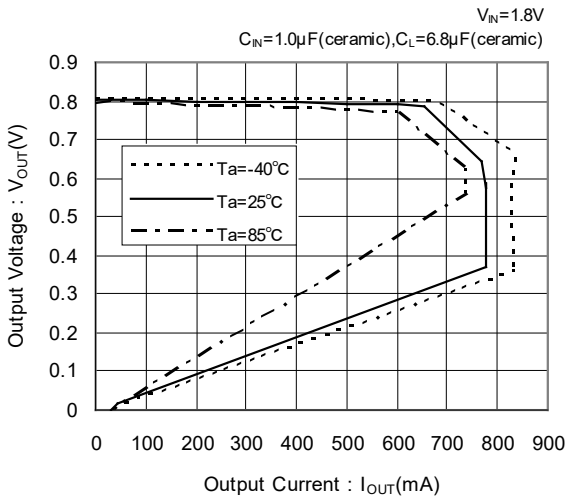

XC6210x082xx

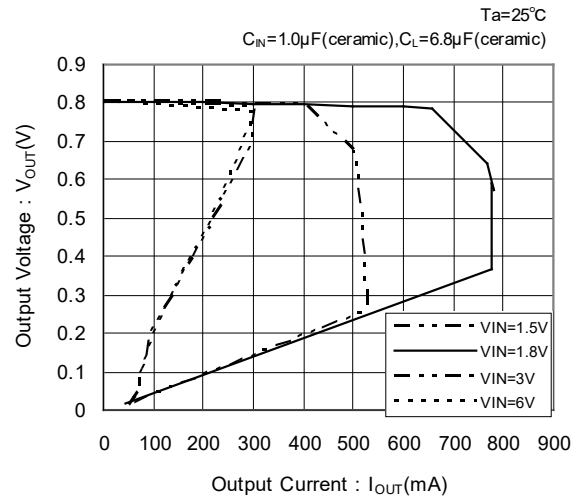

XC6210x302xx

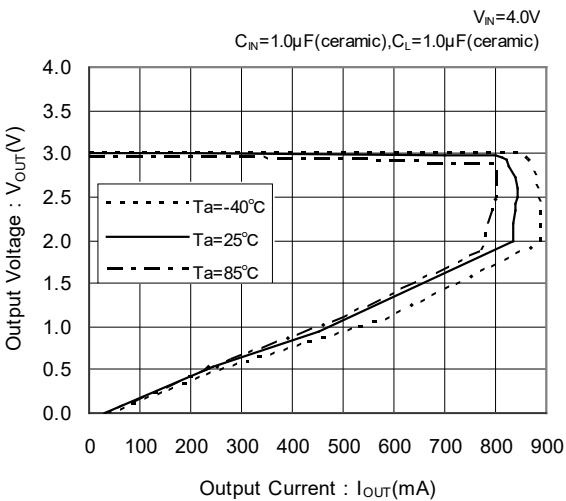

XC6210x302xx

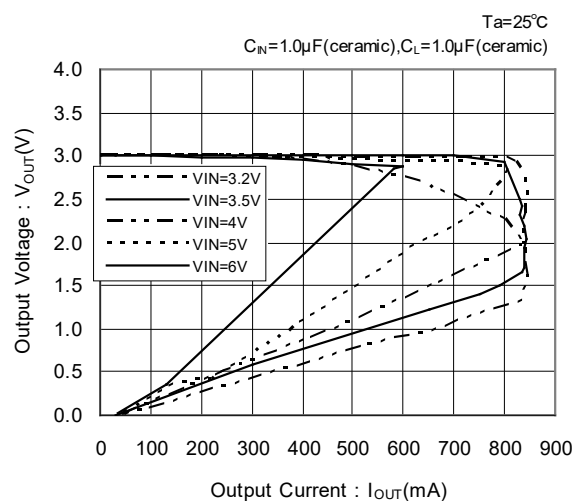

XC6210x502xx

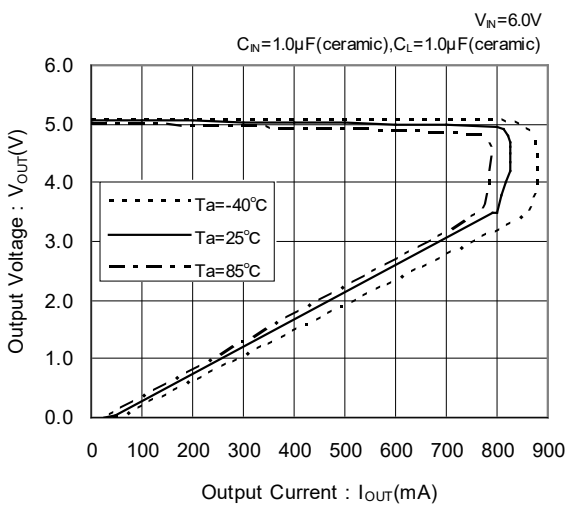

XC6210x502xx

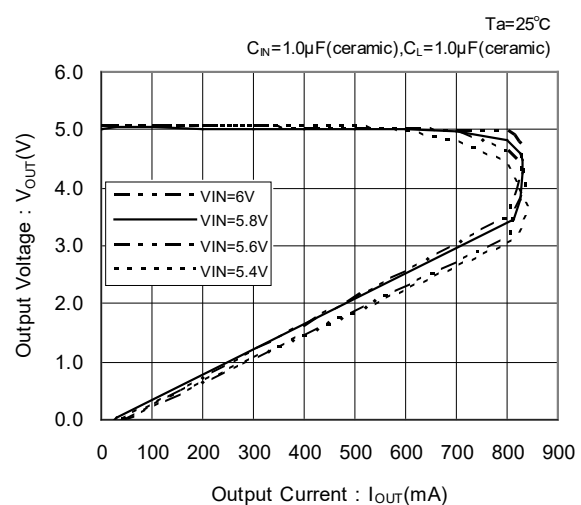

**TYPICAL PERFORMANCE CHARACTERISTICS (Continued)**

(2) Output Voltage vs. Input Voltage

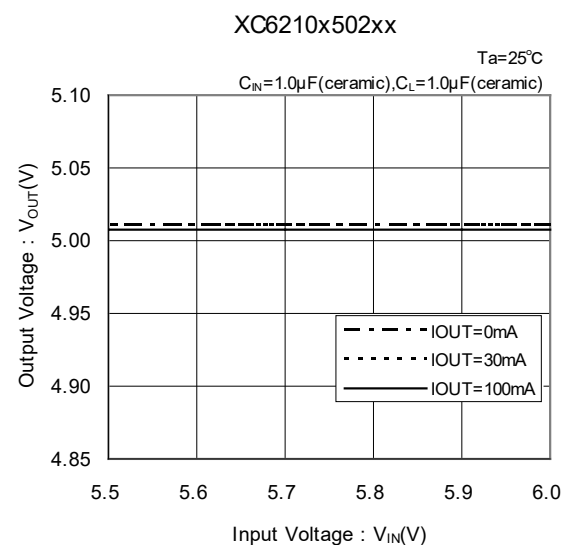
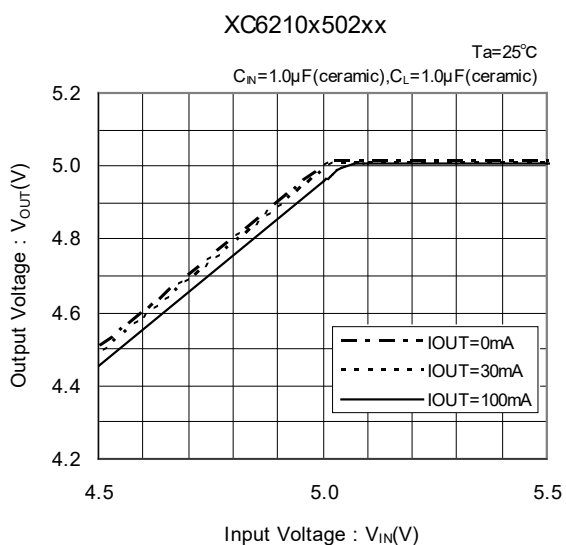
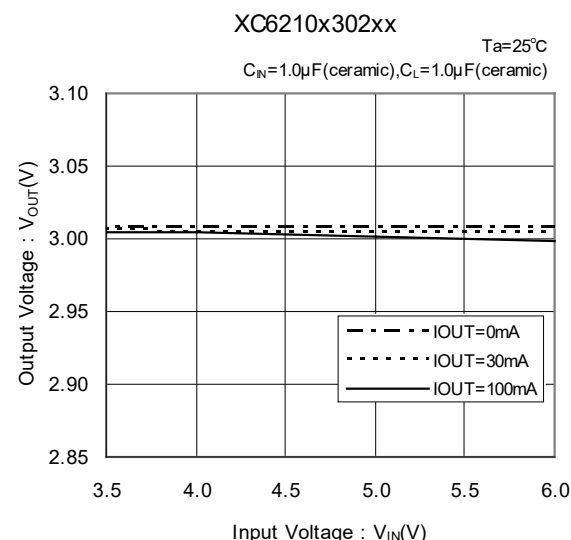
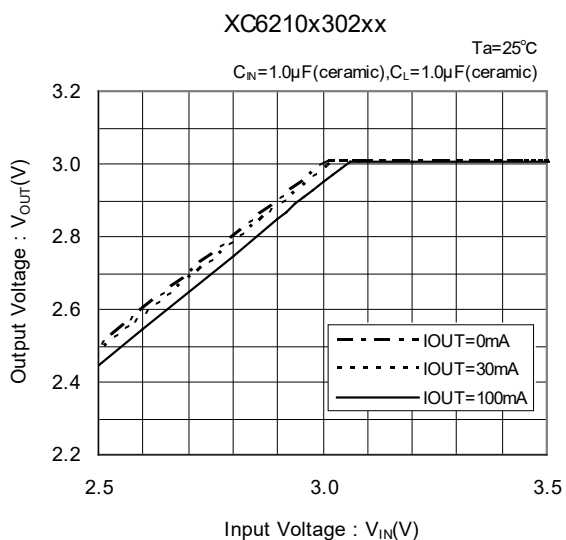
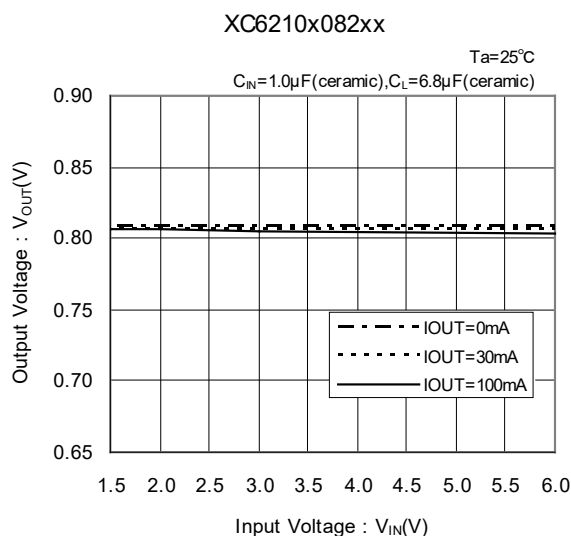
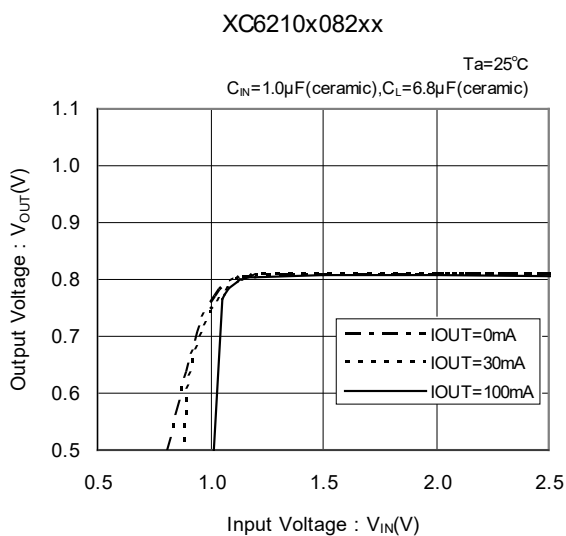

## TYPICAL PERFORMANCE CHARACTERISTICS (Continued)

### (3) Dropout Voltage vs. Output Current

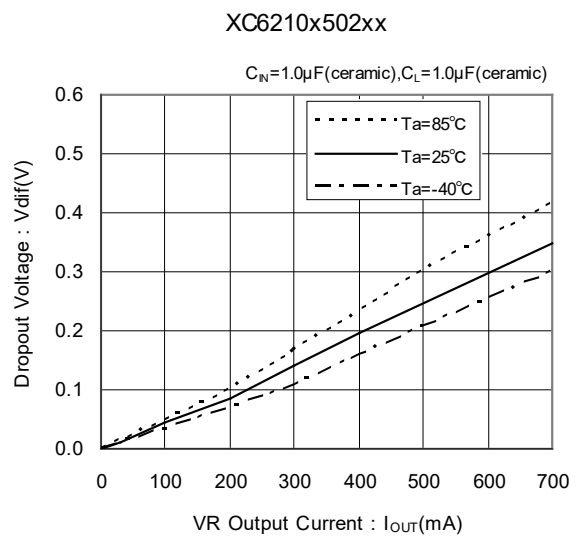
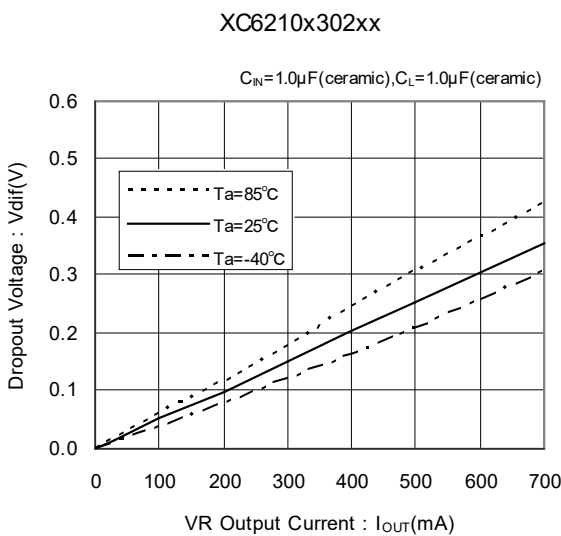
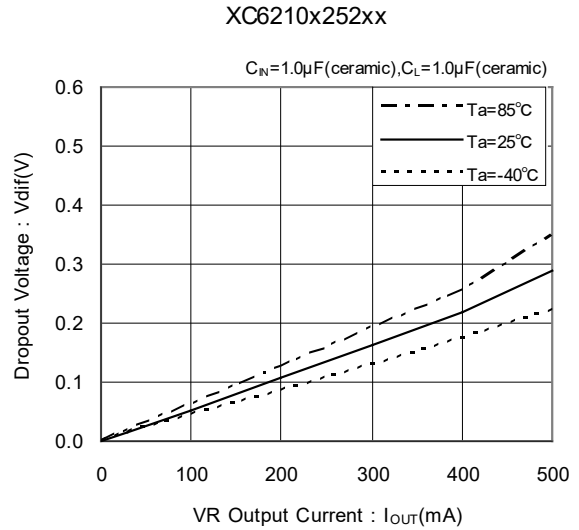
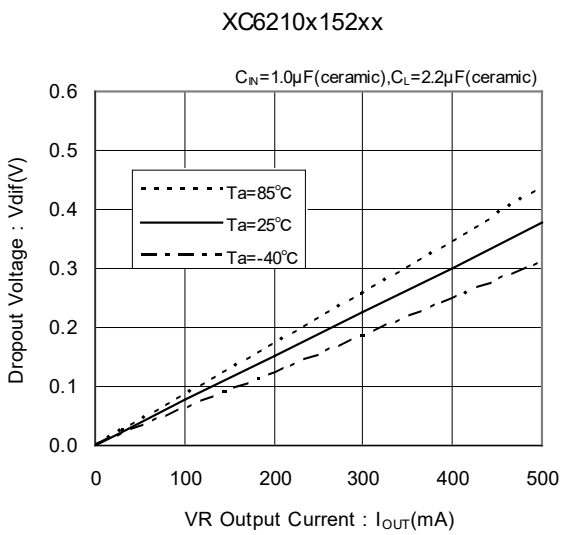
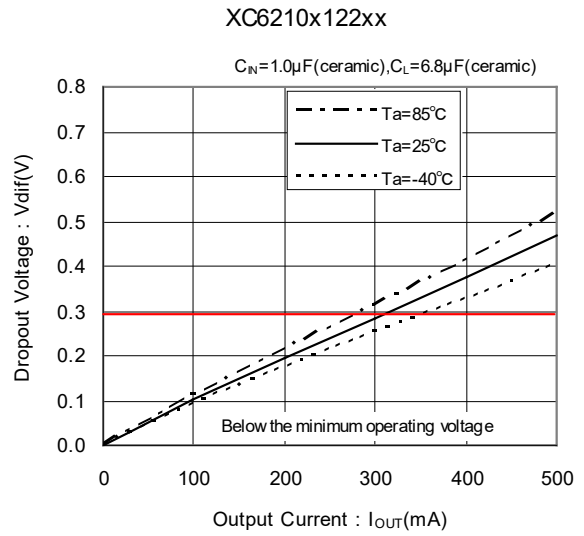
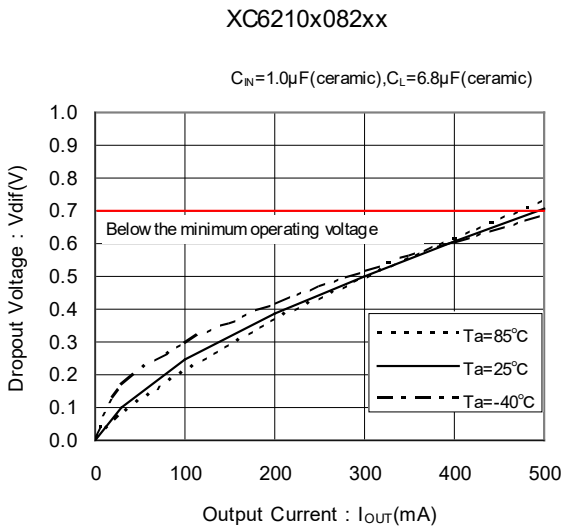

## ■ TYPICAL PERFORMANCE CHARACTERISTICS (Continued)

### (4) Supply Current vs. Input Voltage



### (5) Output Voltage vs. Ambient Temperature

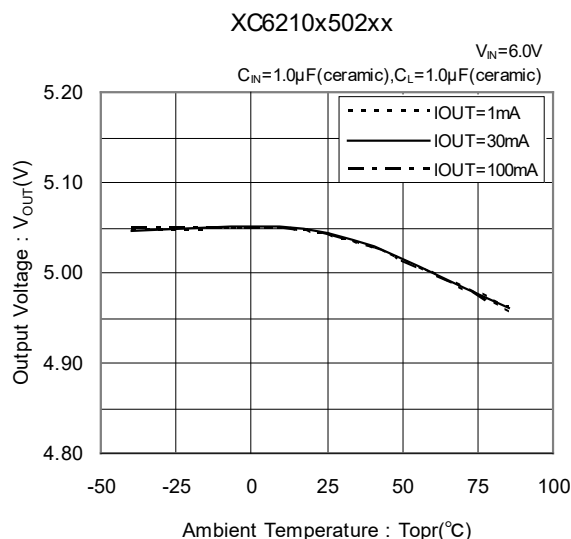
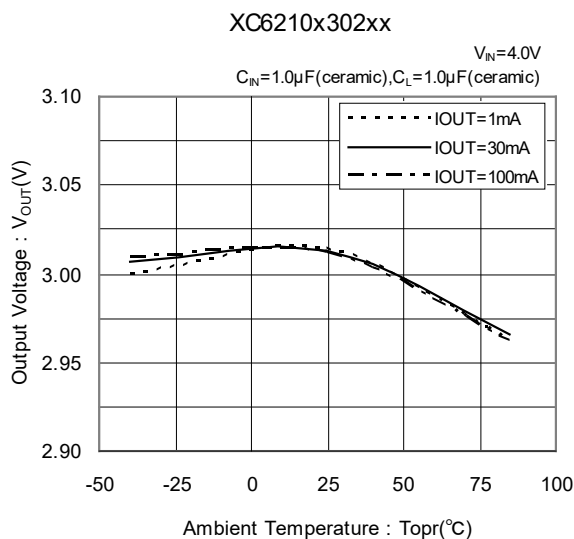
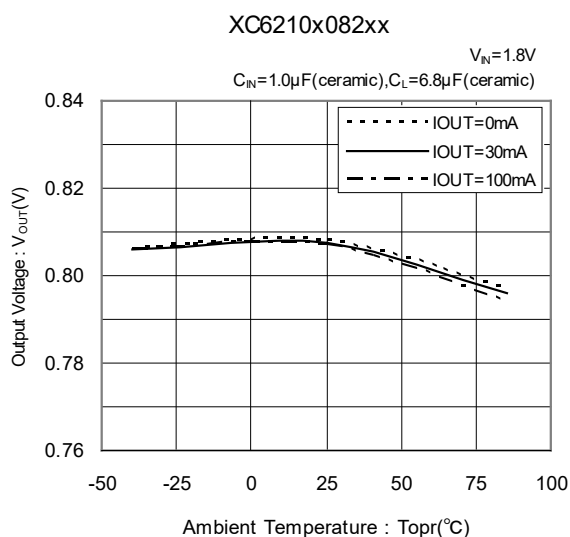
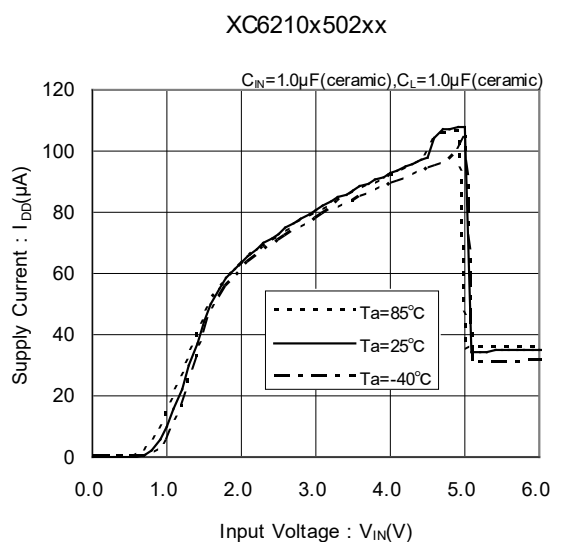

## TYPICAL PERFORMANCE CHARACTERISTICS (Continued)

### (6) Supply Current vs. Ambient Temperature



### (7) CE Pin Threshold Voltage vs. Ambient Temperature

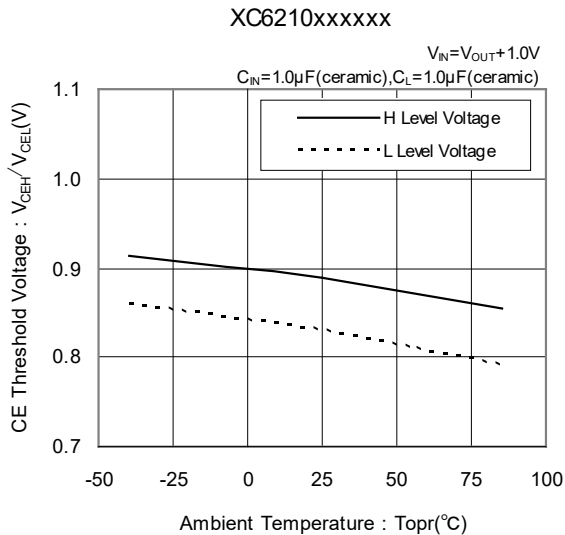



**■ TYPICAL PERFORMANCE CHARACTERISTICS (Continued)**

(8) Input Transient Response 1

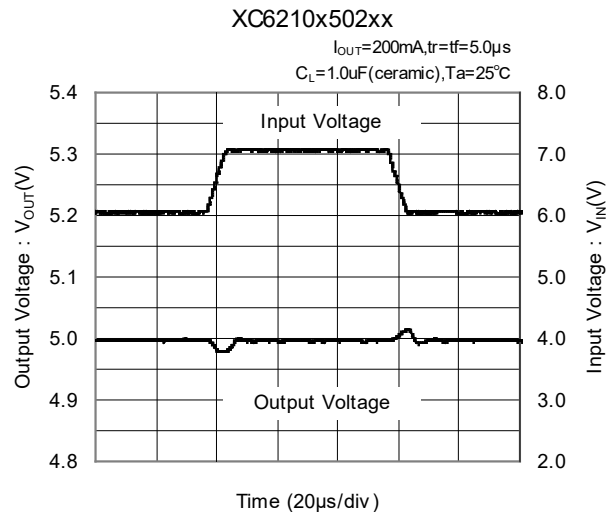
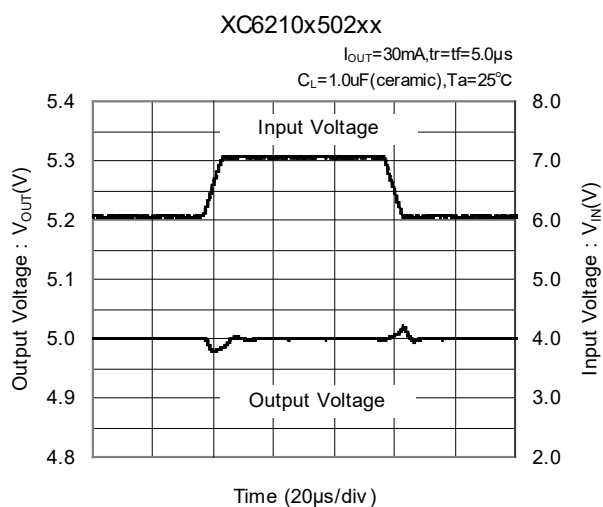

## TYPICAL PERFORMANCE CHARACTERISTICS (Continued)

### (9) Load Transient Response

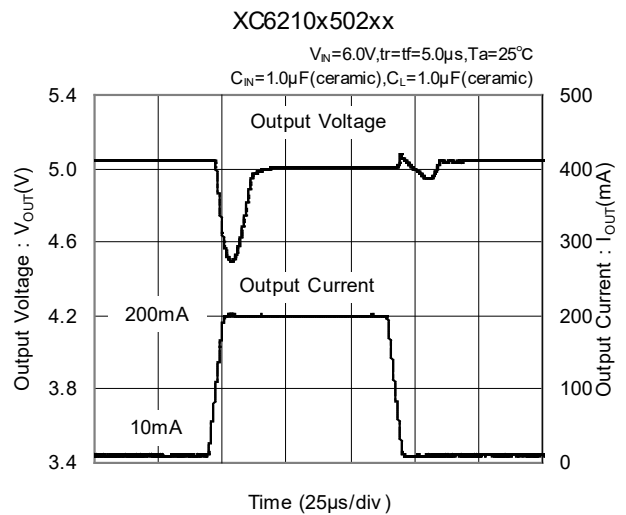
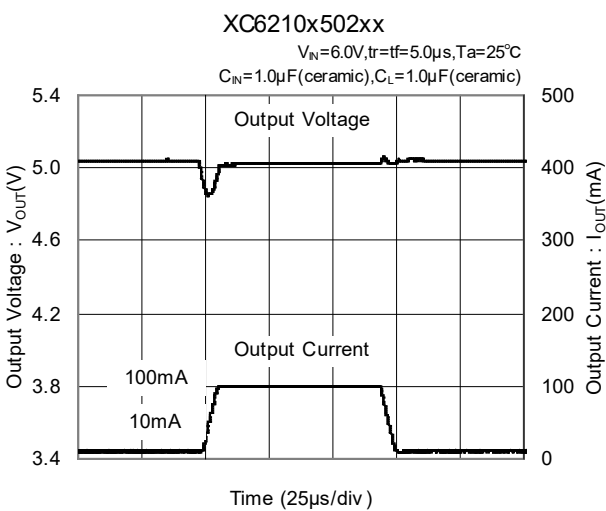
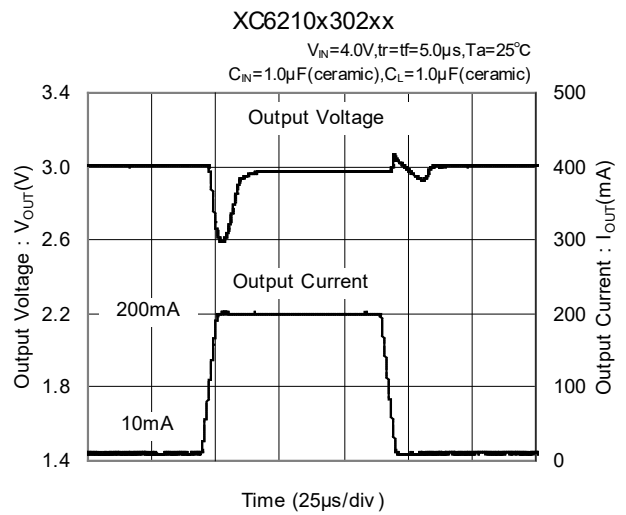
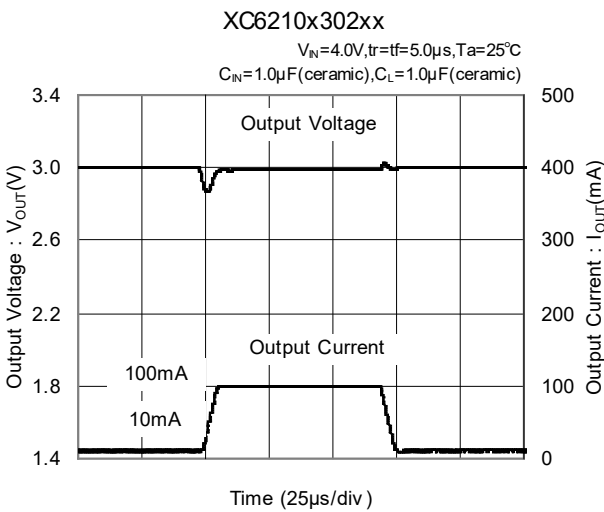
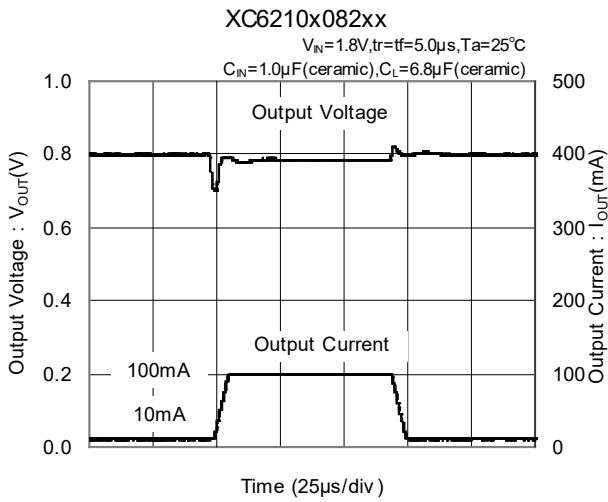

## ■ TYPICAL PERFORMANCE CHARACTERISTICS (Continued)

### (10) Ripple Rejection Rate

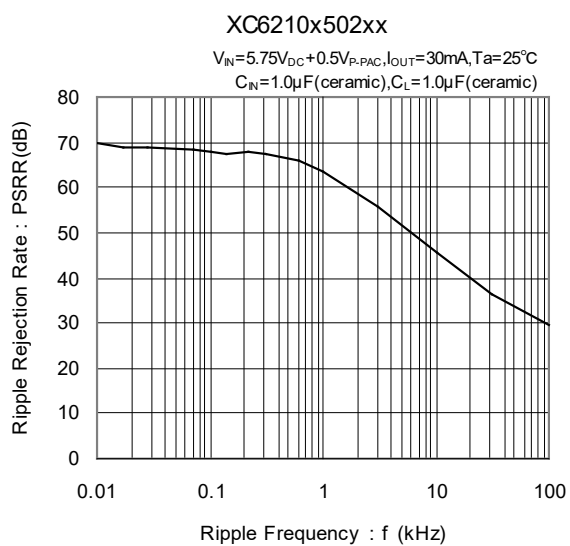
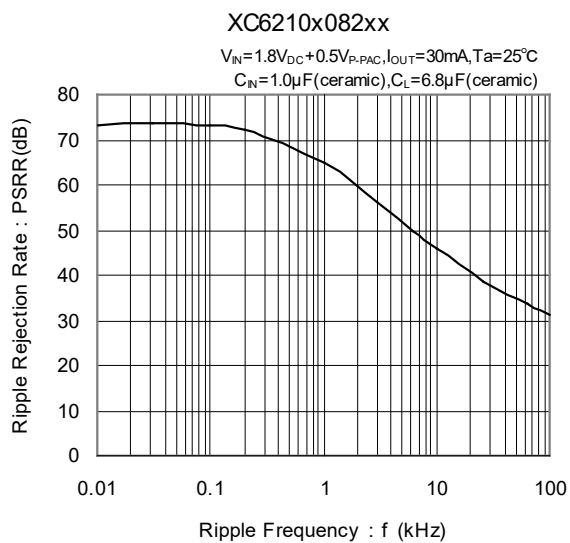

## TYPICAL PERFORMANCE CHARACTERISTICS (Continued)

### (11) Input Transient Response 2

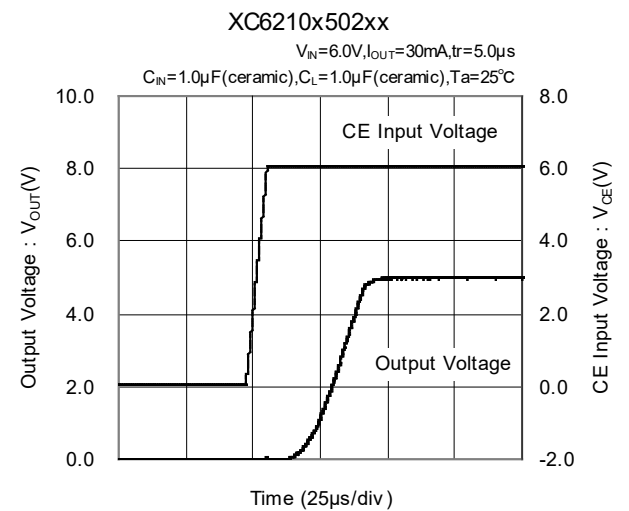
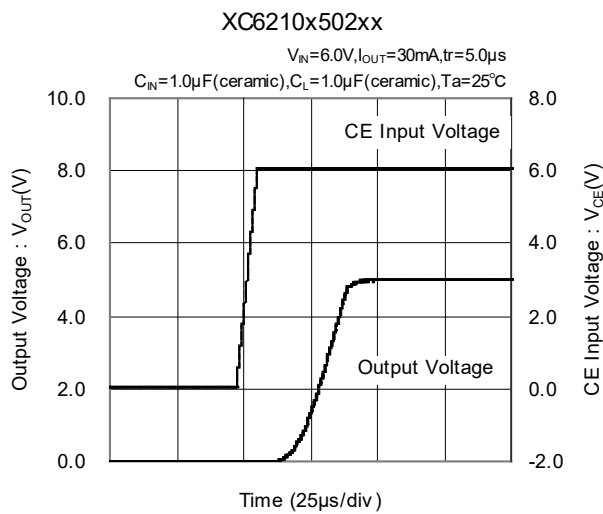
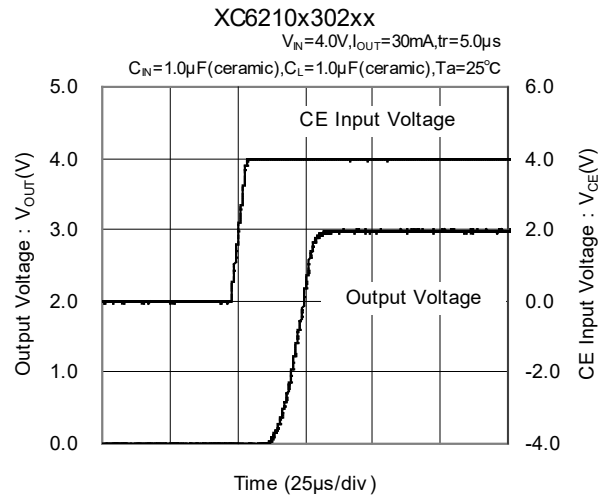
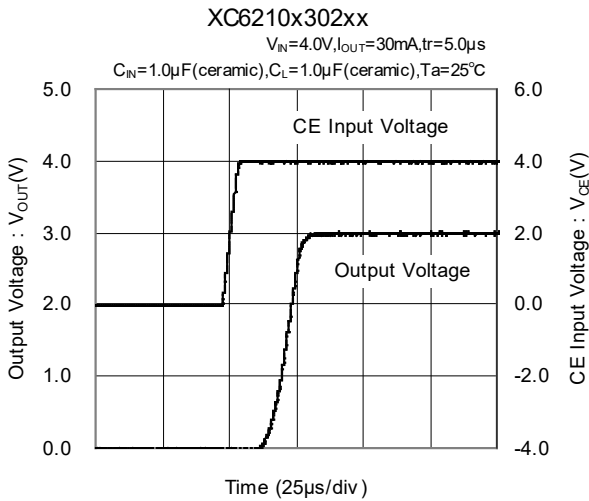
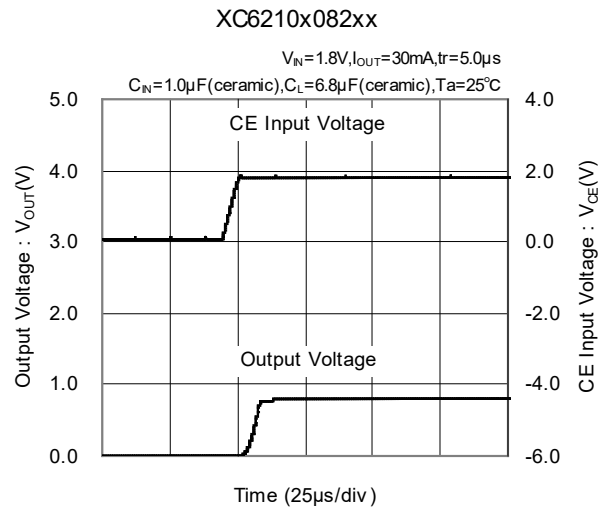
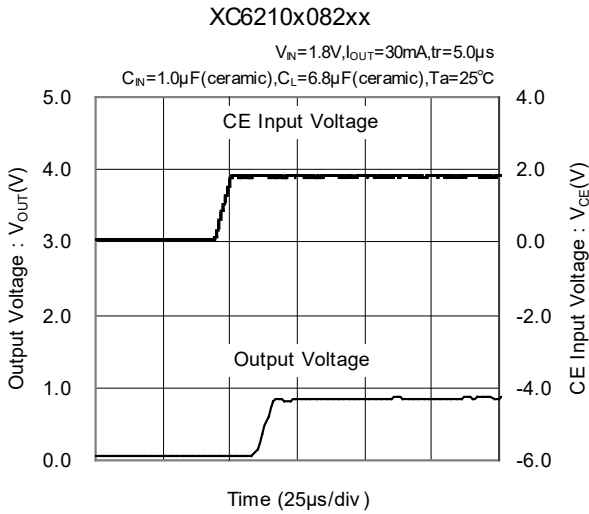

## ■ PACKAGING INFORMATION

For the latest package information go to, [www.torexsemi.com/technical-support/packages](http://www.torexsemi.com/technical-support/packages)

PACKAGE	OUTLINE / LAND PATTERN	THERMAL CHARACTERISTICS	
SOT-25	<a href="#">SOT-25 PKG</a>	Standard Board	<a href="#">SOT-25 Power Dissipation</a>
		JESD51-7 Board	
SOT-89-5	<a href="#">SOT-89-5 PKG</a>	Standard Board	<a href="#">SOT-89-5 Power Dissipation</a>
		JESD51-7 Board	
USP-6B	<a href="#">USP-6B PKG</a>	Standard Board	<a href="#">USP-6B Power Dissipation</a>

## MARKING RULE

### ● SOT-25

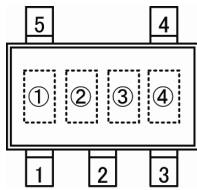

SOT-25  
(TOP VIEW)

### ● SOT-89-5

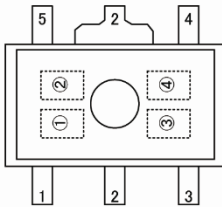

SOT-89-5  
(TOP VIEW)

① represents product series

MARK	PRODUCT SERIES
0	XC6210xxxxxx

② represents CE function

MARK				PRODUCT SERIES
OUTPUT VOLTAGE= 0.80~3.00V	OUTPUT VOLTAGE= 3.10~5.00V	OUTPUT VOLTAGE= 0.85~3.05V	OUTPUT VOLTAGE= 3.15~4.95V	
V	A	E	L	XC6210Axxxxx
X	B	F	M	XC6210Bxxxxx
Y	C	H	N	XC6210Cxxxxx
Z	D	K	P	XC6210Dxxxxx

③ represents output voltage

MARK	OUTPUT VOLTAGE (V)				MARK	OUTPUT VOLTAGE (V)			
	-	3.10	-	3.15		1.60	4.60	1.65	4.65
0	-	3.10	-	3.15	F	1.60	4.60	1.65	4.65
1	-	3.20	-	3.25	H	1.70	4.70	1.75	4.75
2	-	3.30	-	3.35	K	1.80	4.80	1.85	4.85
3	-	3.40	-	3.45	L	1.90	4.90	1.95	4.95
4	-	3.50	-	3.55	M	2.00	5.00	2.05	-
5	-	3.60	-	3.65	N	2.10	-	2.15	-
6	-	3.70	-	3.75	P	2.20	-	2.25	-
7	0.80	3.80	0.85	3.85	R	2.30	-	2.35	-
8	0.90	3.90	0.95	3.95	S	2.40	-	2.45	-
9	1.00	4.00	1.05	4.05	T	2.50	-	2.55	-
A	1.10	4.10	1.15	4.15	U	2.60	-	2.65	-
B	1.20	4.20	1.25	4.25	V	2.70	-	2.75	-
C	1.30	4.30	1.35	4.35	X	2.80	-	2.85	-
D	1.40	4.40	1.45	4.45	Y	2.90	-	2.95	-
E	1.50	4.50	1.55	4.55	Z	3.00	-	3.05	-

④ represents production lot number

0 to 9, A to Z reverse character 0 to 9, A to Z repeated (G, I, J, O, Q, W excluded)

## MARKING RULE (Continued)

● USP-6B

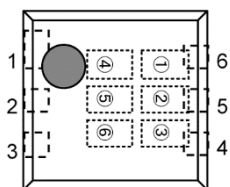

USP-6B  
(TOP VIEW)

①② represents product series

MARK		PRODUCT SERIES
①	②	
1	0	XC6210xxxxxx

③ represents CE Function

MARK	TYPE	PRODUCT SERIES
A	CE High Active with pull-down resistor	XC6210AxxxDx
B	CE High Active with no pull-down resistor	XC6210BxxxDx
C	CE Low Active with pull-up resistor	XC6210CxxxDx
D	CE Low Active with no pull-up resistor	XC6210DxxxDx

④ represents the integer number of output voltage  
ex.)

MARK	VOLTAGE (V)	PRODUCT SERIES
3	3.x	XC6210x3xxDx
5	5.x	XC6210x5xxDx

⑤ represents the decimal point of output voltage

MARK	VOLTAGE (V)	PRODUCT SERIES	MARK	VOLTAGE (V)	PRODUCT SERIES
0	x.00	XC6210xx02Dx	A	x.05	XC6210xx0ADx
1	x.10	XC6210xx12Dx	B	x.15	XC6210xx1ADx
2	x.20	XC6210xx22Dx	C	x.25	XC6210xx2ADx
3	x.30	XC6210xx32Dx	D	x.35	XC6210xx3ADx
4	x.40	XC6210xx42Dx	E	x.45	XC6210xx4ADx
5	x.50	XC6210xx52Dx	F	x.55	XC6210xx5ADx
6	x.60	XC6210xx62Dx	H	x.65	XC6210xx6ADx
7	x.70	XC6210xx72Dx	K	x.75	XC6210xx7ADx
8	x.80	XC6210xx82Dx	L	x.85	XC6210xx8ADx
9	x.90	XC6210xx92Dx	M	x.95	XC6210xx9ADx

⑥ represents production lot number  
0 to 9, A to Z repeated (G, I, J, O, Q, W, excluded)  
Note: No character inversion used.