

28V Low Power Consumption 150mA Voltage Regulators (with Stand-by Function)

■ GENERAL DESCRIPTION

XC6216/XE6216 series are positive voltage regulator ICs with 28V of operation voltage. The series consists of a voltage reference, an error amplifier, a current limiter, a thermal shutdown circuit and a phase compensation circuit plus a driver transistor.

The output voltage is selectable in 0.1V increments within the range of 1.8V to 12V using laser trimming technologies. With external resistors, the output voltage range can be expanded from 2.0V to 23V. The output stabilization capacitor (CL) is also compatible with low ESR ceramic capacitors.

The over current protection circuit and the thermal shutdown circuit are built-in. These two protection circuits will operate when the output current reaches current limit level or the junction temperature reaches temperature limit level.

The CE function enables the output to be turned off and the IC becomes a stand-by mode resulting in greatly reduced power consumption.

■ APPLICATIONS

- Car audio, Car navigation systems
- Note PCs / Tablet PCs
- Mobile devices / terminals
- Digital still cameras / Camcorders
- Smart phones / Mobile phones
- Multi-function power supplies

■ FEATURES

Max Output Current	: More than 150mA (200mA limit) ($V_{IN}=V_{OUT}+3.0V$)
Dropout Voltage	: 300mV@ $I_{OUT}=20mA$
Input Voltage Range	: 2.0V~28.0V
Output Voltage Range	: 1.8V~12.0V (0.1V increments) 2.0V~23V with external resistors
Fixed Output Accuracy	: $\pm 2\%$ $\pm 1\%$ ($V_{out} \geq 2.00V$) $\pm 20mV$ ($V_{out} \leq 1.9V$)
Low Power Consumption	: 5 μA
Stand-by Current	: Less than 0.1 μA
High Ripple Rejection	: 30dB@1kHz
Operating Temperature	: -40°C~+85°C
Low ESR Capacitor	: Ceramic Capacitor Compatible
Built-in Protection	: Current Limit Circuit Thermal Shutdown Circuit
Operating Ambient Temperature	: -40°C ~ +85°C
Packages	: SOT-25, SOT-89, SOT-89-5, USP-6C, SOT-223, TO-252 USP-6B06, SOT-23
Environmentally Friendly	: EU RoHS Compliant, Pb Free

■ TYPICAL APPLICATION CIRCUIT

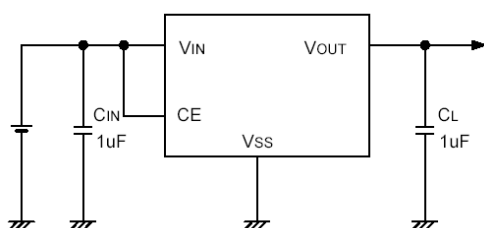

Fixed Output Voltage
XC6216B/XE6216B Series

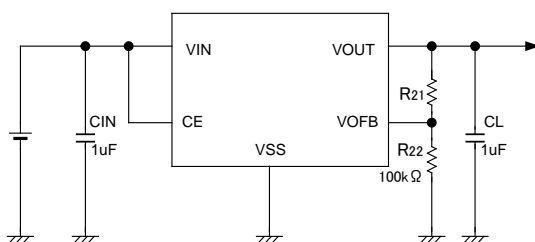

Output Voltage External Setting
XC6216C Series

■ TYPICAL PERFORMANCE CHARACTERISTICS

- Output Voltage vs. Input Voltage



XC6216/XE6216 Series

■ BLOCK DIAGRAMS

● XC6216 Series

● XC6216 Series B Type

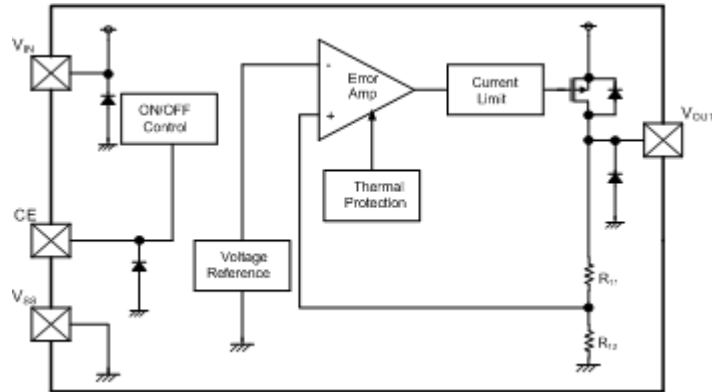

● XC6216 Series C Type

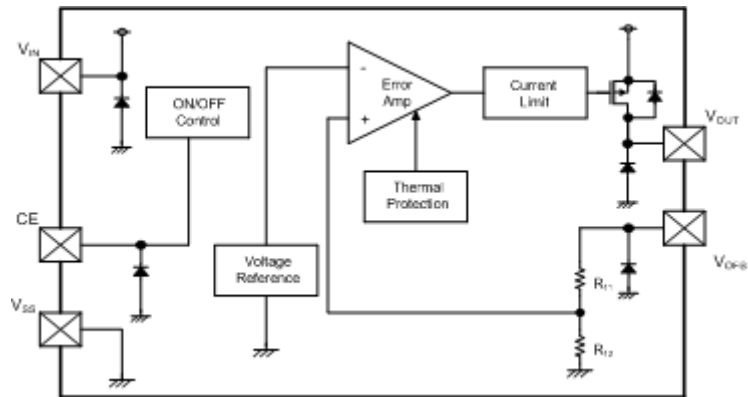

● XC6216 Series D Type

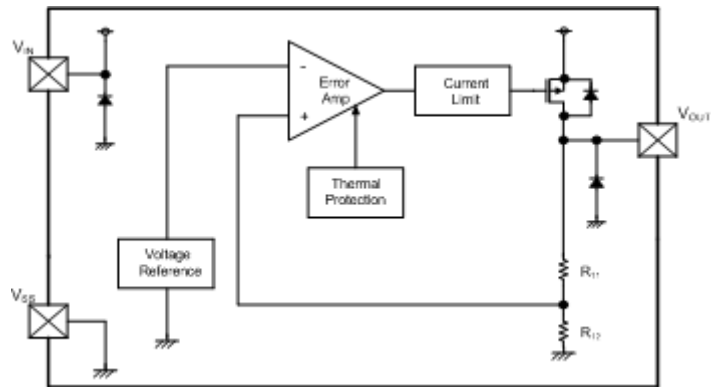

● XE6216 Series

● XE6216 Series B Type

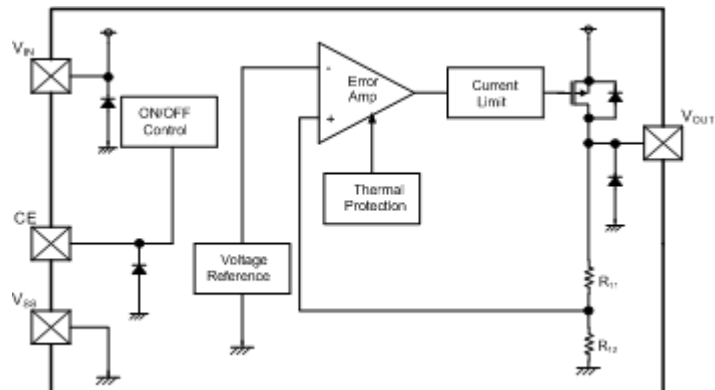

*Diodes inside the circuit are an ESD protection diode and parasitic diodes.

■ PRODUCT CLASSIFICATION

● Ordering Information

XC6216①②③④⑤⑥-⑦^(*): CE function (Active High) Fixed output voltage 1.8V ~ 12.0V(0.1V increments)

DESIGNATOR	ITEM	SYMBOL	DESCRIPTION
①	Type and Options of Regulators	B	Fixed output voltage
		C	Output voltage externally set ($V_{OFB}=2.0V$) ^(*)
②③	Output Voltage	18 ~ C0	For the voltage within 1.8V ~ 9.9V (0.1V increments); e.g. 2.5V ⇒ 25, 5.0V ⇒ 50
			For the voltage within 10.0V ~ 12.0V (0.1V increments); e.g. 10.6V ⇒ A6, 11.2V ⇒ B2, 12.0V ⇒ C0
		20	For C type (output voltage externally set), $V_{OFB}=2.0V$ only
④	Output Voltage Accuracy ^(*)	2	±2%
		1	$V_{OUT} \geq 2.00V : \pm 1\%, V_{OUT} \leq 1.9V : \pm 20mV$ ^(*)
⑤⑥-⑦ ^(*)	Packages (Order Unit)	MR	SOT-25 (3,000pcs/Reel)
		MR-G	SOT-25 (3,000pcs/Reel)
		PR	SOT-89-5 (1,000pcs/Reel)
		PR-G	SOT-89-5 (1,000pcs/Reel)
		ER	USP-6C (3,000pcs/Reel)
		ER-G	USP-6C (3,000pcs/Reel)
		8R-G	USP-6B06 (5,000pcs/Reel)

^(*) The "-G" suffix denotes Halogen and Antimony free as well as being fully EU RoHS compliant.

^(*) For the Type C, the accuracy is based on V_{OFB} voltage. The actual output voltage accuracy is depended on the external resistances.

^(*) For the Type C and Output Voltage Accuracy±1% (±20mV) do not have USP-6B06 package

XC6216D①②③④⑤-⑥^(*): 3 pin regulator (No CE function), Fixed output voltage 1.8V ~ 12.0V(0.1V increments)

DESIGNATOR	ITEM	SYMBOL	DESCRIPTION
①②	Output Voltage	20 ~ C0	For the voltage within 1.8V ~ 9.9V (0.1V increments); e.g. 2.5V ⇒ 25, 5.0V ⇒ 50
			For the voltage within 10.0V ~ 12.0V (0.1V increments); e.g. 10.6V ⇒ A6, 11.2V ⇒ B2, 12.0V ⇒ C0
③	Output Voltage Accuracy	2	±2%
		1	$V_{OUT} \geq 2.00V : \pm 1\%, V_{OUT} \leq 1.9V : \pm 20mV$
④⑤-⑥ ^(*)	Packages (Order Unit)	PR	SOT-89 (1,000pcs/Reel)
		PR-G	SOT-89 (1,000pcs/Reel)
		FR	SOT-223 (1,000pcs/Reel)
		FR-G	SOT-223 (1,000pcs/Reel)
		JR	TO-252 (2,500pcs/Reel)
		JR-G	TO-252 (2,500pcs/Reel)
		MR-G	SOT-23 (3,000pcs/Reel)

^(*) The "-G" suffix denotes Halogen and Antimony free as well as being fully EU RoHS compliant.

XE6216B①②③④⑤-⑥^(*): CE function (Active High), Fixed output voltage 2.0V ~ 12.0V(0.1V increments)

Characteristics are guaranteed over the temperature range of -40°C to 85°C.

DESIGNATOR	ITEM	SYMBOL	DESCRIPTION
①②	Output Voltage	20 ~ C0	For the voltage within 2.0V ~ 9.9V (0.1V increments); e.g. 2.5V ⇒ 25, 5.0V ⇒ 50
			For the voltage within 10.0V ~ 12.0V (0.1V increments); e.g. 10.6V ⇒ A6, 11.2V ⇒ B2, 12.0V ⇒ C0
③	Output Voltage Accuracy	2	±2%
④⑤-⑥ ^(*)	Package (Order Unit)	PR	SOT-89-5 (1,000pcs/Reel)
		PR-G	SOT-89-5 (1,000pcs/Reel)

^(*) The "-G" suffix denotes Halogen and Antimony free as well as being fully EU RoHS compliant.

XC6216/XE6216 Series

PIN CONFIGURATION

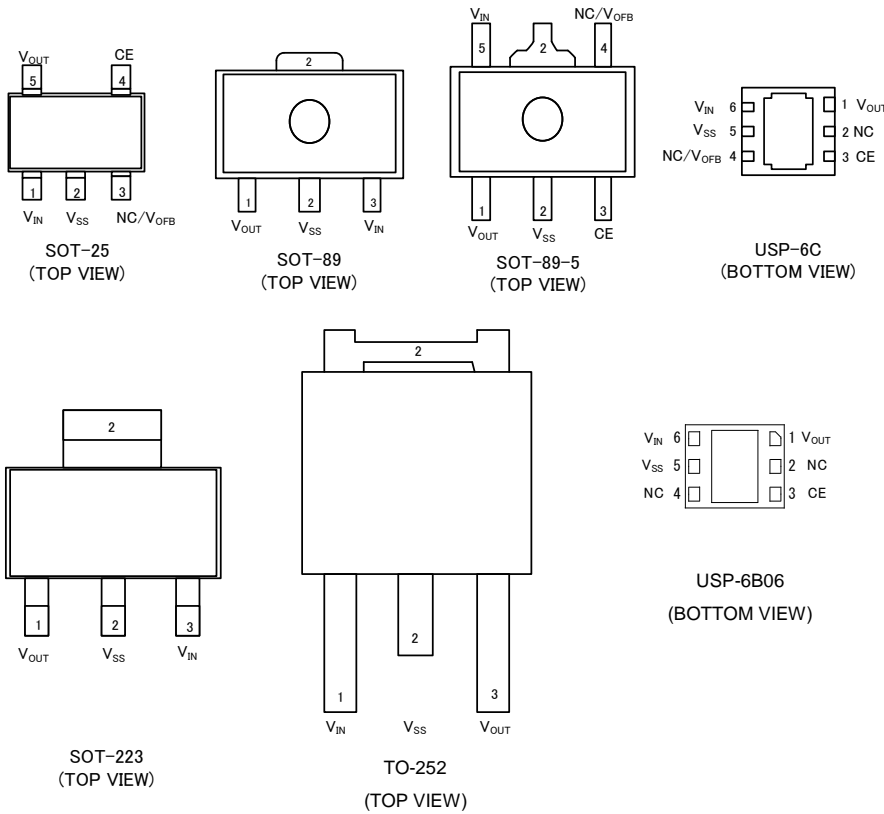

* The dissipation pad for the USP-6C and USP-6B06 packages should be solder-plated in reference mount pattern and metal masking so as to enhance mounting strength and heat release. If the pad needs to be connected to other pins, it should be connected to the V_{SS} (No. 5) pin.

PIN ASSIGNMENT

●XC6216 Series B Type

PIN NUMBER				PIN NAME	FUNCTIONS
SOT-25	SOT-89-5	USP-6C	USP-6B06		
1	5	6	6	V_{IN}	Power Input
2	2	5	5	V_{SS}	Ground
3	4	2,4	2,4	NC	No connection
4	3	3	3	CE	ON/OFF Control
5	1	1	1	V_{OUT}	Output

●XC6216 Series C Type

PIN NUMBER			PIN NAME	FUNCTIONS
SOT-25	SOT-89-5	USP-6C		
1	5	6	V_{IN}	Power Input
2	2	5	V_{SS}	Ground
3	4	4	V_{OFB}	Output Voltage Adjustment
4	3	3	CE	ON/OFF Control
5	1	1	V_{OUT}	Output
-	-	2	NC	No connection

●XC6216 Series D Type

PIN NUMBER				PIN NAME	FUNCTIONS
SOT-89	SOT-223	TO-252	SOT-23		
3	3	1	2	V_{IN}	Power Input
2	2	2	3	V_{SS}	Ground
1	1	3	1	V_{OUT}	Output

■ PIN ASSIGNMENT

●XC6216 Series B Type

PIN NUMBER	PIN NAME	FUNCTIONS
	SOT-89-5	
1	V _{OUT}	Output
2	V _{SS}	Ground
3	CE	ON/OFF Control
4	NC	No connection
5	V _{IN}	Power Input

■ LOGIC CONDITION FOR THE PIN

PIN NAME	DESIGNATOR	CONDITIONS	IC OPERATION
CE	L	$0V \leq V_{CE} \leq 0.35V$	OFF
	H	$1.1V \leq V_{CE} \leq 28.0V$	ON
	OPEN	CE=OPEN	Undefined state

* Please avoid the state of OPEN, and make CE Pin arbitrary fixed potential.

(XC6216 Series B Type, XE6216 Series B Type, XC6216 Series C Type)

■ PIN FUNCTION ASSIGNMENT

SERIES	CHIP ENABLE PIN
XC6216 Series B Type/XE6216 Series B Type	Available
XC6216 Series C Type	Available
XC6216 Series D Type	Not Available

■ ABSOLUTE MAXIMUM RATINGS

●XC6216 Series B Type

PARAMETER	SYMBOL	RATINGS	UNITS
Input Voltage	V _{IN}	V _{SS} -0.3 ~ +30	V
Output Current	I _{OUT}	300 ^(*)	mA
Output Voltage	V _{OUT}	V _{SS} -0.3 ~ V _{IN} +0.3	V
CE Input Voltage	V _{CE}	V _{SS} -0.3 ~ 30	V
Power Dissipation (Ta=25°C)	SOT-25	250	mW
		600 (40mm x 40mm Standard board) ^(*)	
		760 (JESD51-7 board) ^(*)	
		500	
	SOT-89-5	1300 (40mm x 40mm Standard board) ^(*)	
		1750 (JESD51-7 board) ^(*)	
	USP-6C	120	
		1000 (40mm x 40mm Standard board) ^(*)	
USP-6B06	1250 (JESD51-7 board) ^(*)		
900 (40mm x 40mm Standard board) ^(*)			
Operating Ambient Temperature	Topr	-40 ~ +85	°C
Storage Temperature	Tstg	-55 ~ +125	°C

^(*)Pd > (V_{IN}-V_{OUT}) × I_{OUT}

^(*) The power dissipation figure shown is PCB mounted and is for reference only.

The mounting condition is please refer to PACKAGING INFORMATION.

ABSOLUTE MAXIMUM RATINGS (Continued)

●XC6216 Series C Type

PARAMETER		SYMBOL	RATINGS	UNITS
Input Voltage		V_{IN}	$V_{SS}-0.3 \sim +30$	V
Output Current		I_{OUT}	300 ^{(*)1}	mA
Output Voltage		V_{OUT}	$V_{SS}-0.3 \sim V_{IN}+0.3$	V
CE Input Voltage		V_{CE}	$V_{SS}-0.3 \sim +30$	V
FB Voltage		V_{OFB}	$V_{SS}-0.3 \sim +30$	V
Power Dissipation ($T_a=25^\circ\text{C}$)	SOT-25	Pd	250	mW
			600 (40mm x 40mm Standard board) ^{(*)2}	
			760 (JESD51-7 board) ^{(*)2}	
	SOT-89-5		500	
			1300 (40mm x 40mm Standard board) ^{(*)2}	
	USP-6C		1750 (JESD51-7 board) ^{(*)2}	
			120	
		1000 (40mm x 40mm Standard board) ^{(*)2}		
		1250 (JESD51-7 board) ^{(*)2}		
Operating Ambient Temperature		T_{opr}	$-40 \sim +85$	$^\circ\text{C}$
Storage Temperature		T_{stg}	$-55 \sim +125$	$^\circ\text{C}$

^{(*)1} $P_d > (V_{IN}-V_{OUT}) \times I_{OUT}$

^{(*)2} The power dissipation figure shown is PCB mounted and is for reference only.

The mounting condition is please refer to PACKAGING INFORMATION.

●XC6216D Series

PARAMETER		SYMBOL	RATINGS	UNITS
Input Voltage		V_{IN}	$V_{SS}-0.3 \sim +30$	V
Output Current		I_{OUT}	300 ^{(*)1}	mA
Output Voltage		V_{OUT}	$V_{SS}-0.3 \sim V_{IN}+0.3$	V
Power Dissipation ($T_a=25^\circ\text{C}$)	SOT-89	Pd	500	mW
			1000 (40mm x 40mm Standard board) ^{(*)2}	
	SOT-223		300	
			1500 (40mm x 40mm Standard board) ^{(*)2}	
	TO-252		500	
			1800 (40mm x 40mm Standard board) ^{(*)2}	
	SOT-23		250	
730 (JESD51-7 board) ^{(*)2}				
		500 (40mm x 40mm Standard board) ^{(*)2}		
Operating Ambient Temperature		T_{opr}	$-40 \sim +85$	$^\circ\text{C}$
Storage Temperature		T_{stg}	$-55 \sim +125$	$^\circ\text{C}$

^{(*)1} $P_d > (V_{IN}-V_{OUT}) \times I_{OUT}$

^{(*)2} The power dissipation figure shown is PCB mounted and is for reference only.

The mounting condition is please refer to PACKAGING INFORMATION.

●XE6216 Series B Type

PARAMETER		SYMBOL	RATINGS	UNITS
Input Voltage		V_{IN}	$V_{SS}-0.3 \sim +30$	V
Output Current		I_{OUT}	300 ^{(*)1}	mA
Output Voltage		V_{OUT}	$V_{SS}-0.3 \sim V_{IN}+0.3$	V
CE Input Voltage		V_{CE}	$V_{SS}-0.3 \sim +30$	V
Power Dissipation ($T_a=25^\circ\text{C}$)	SOT-89-5	Pd	500	mW
			1300 (40mm x 40mm Standard board) ^{(*)2}	
			1750 (JESD51-7 board) ^{(*)2}	
Operating Ambient Temperature		T_{opr}	$-40 \sim +85$	$^\circ\text{C}$
Junction Temperature		T_J	$-40 \sim +125$	$^\circ\text{C}$
Storage Temperature		T_{stg}	$-55 \sim +125$	$^\circ\text{C}$

^{(*)1} $P_d > (V_{IN}-V_{OUT}) \times I_{OUT}$

^{(*)2} The power dissipation figure shown is PCB mounted and is for reference only.

The mounting condition is please refer to PACKAGING INFORMATION.

ELECTRICAL CHARACTERISTICS

●XC6216 Series B Type

Ta=25°C

PARAMETER	SYMBOL	CONDITIONS	MIN.	TYP.	MAX.	UNITS	CIRCUIT
Output Voltage	V _{OUT(E)} ^(*2)	I _{OUT} =20mA, V _{CE} =V _{IN}	E-0			V	①
Maximum Output Current	I _{OUTMAX}	V _{IN} =V _{OUT(T)} +3.0V, V _{CE} =V _{IN} ^(*1) (V _{OUT(T)} ≥3.0V)	150	-	-	mA	①
		V _{IN} =V _{OUT(T)} +3.0V, V _{CE} =V _{IN} ^(*1) (V _{OUT(T)} <3.0V)	100	-	-	mA	①
Load Regulation	ΔV _{OUT}	1mA≤I _{OUT} ≤50mA, V _{CE} =V _{IN} (1.8V≤V _{OUT(T)} ≤7.0V)	-	50	90	mV	①
		1mA≤I _{OUT} ≤50mA, V _{CE} =V _{IN} (7.0<V _{OUT(T)} ≤12.0V)	-	110	140	mV	①
Dropout Voltage 1	V _{dif1} ^(*3)	I _{OUT} =20mA, V _{CE} =V _{IN}	-	E-1		mV	①
Dropout Voltage 2	V _{dif2} ^(*3)	I _{OUT} =100mA, V _{CE} =V _{IN}	-	E-2		mV	①
Supply Current	I _{SS}	V _{CE} =V _{IN}	1	5	9	μA	②
Stand-by Current	I _{STB}	V _{CE} =V _{SS}	-	0.01	0.10	μA	②
Line Regulation 1	ΔV _{OUT} / (ΔV _{IN} · V _{OUT})	V _{OUT(T)} +2.0V≤V _{IN} ≤28.0V ^(*1) I _{OUT} =5mA, V _{CE} =V _{IN}	-	0.05	0.10	%/V	①
Line Regulation 2	ΔV _{OUT} / (ΔV _{IN} · V _{OUT})	V _{OUT(T)} +2.0V≤V _{IN} ≤28.0V ^(*1) I _{OUT} =13mA, V _{CE} =V _{IN}	-	0.15	0.30	%/V	①
Input Voltage	V _{IN}		2.0	-	28.0	V	-
Output Voltage Temperature Characteristics	ΔV _{OUT} / (ΔT _{opr} · V _{OUT})	I _{OUT} =20mA, V _{CE} =V _{IN} -40°C≤T _{opr} ≤85°C	-	±100	-	ppm/°C	①
Power Supply Rejection Ratio	PSRR	V _{IN} =[V _{OUT(T)} +2.0]V+0.5Vp-pA ^(*1) I _{OUT} =20mA, f=1kHz, V _{CE} =V _{IN}	-	30	-	dB	③
Short Current	I _{SHORT}	V _{CE} =V _{IN} ^(*1)	-	30	-	mA	①
CE "H" Level Voltage	V _{CEH}	-	1.1	-	28.0	V	①
CE "L" Level Voltage	V _{CEL}	-	0	-	0.35	V	①
CE "H" Level Current	I _{CEH}	V _{IN} =V _{CE} =28.0V	-0.1	-	0.1	μA	①
CE "L" Level Current	I _{CEL}	V _{IN} =28.0V, V _{CE} =V _{SS}	-0.1	-	0.1	μA	①
Thermal Shutdown Detect Temperature	T _{TSD}	V _{CE} =V _{IN} Junction Temperature	-	150	-	°C	①
Thermal Shutdown Release Temperature	T _{TSR}	V _{CE} =V _{IN} Junction Temperature	-	125	-	°C	①
Hysteresis Width	T _{TSD} -T _{TSR}	V _{CE} =V _{IN} Junction Temperature	-	25	-	°C	-

Unless otherwise stated, V_{IN}=V_{OUT(T)}+2.0V.

NOTE:

*1: V_{OUT(T)}: Nominal output voltage

*2: V_{OUT(E)}: Effective output voltage

(i.e. the output voltage when "V_{OUT(T)}+2.0V" is provided at the V_{IN} pin while maintaining a certain I_{OUT} value.)

*3: V_{dif}={V_{IN1} - V_{OUT1}}

V_{OUT1}: V_{OUT(T)}<3.0V, A voltage equal to 98% of the output voltage whenever an amply stabilized I_{OUT}{V_{OUT(T)}+3.0V} is input.

V_{OUT(T)}≥3.0V, A voltage equal to 98% of the output voltage whenever an amply stabilized I_{OUT}{V_{OUT(T)}+2.0V} is input.

V_{IN1}: The input voltage when V_{OUT1} appears as input voltage is gradually decreased.

ELECTRICAL CHARACTERISTICS (Continued)

●XC6216 Series C Type

Ta=25°C

PARAMETER	SYMBOL	CONDITIONS	MIN.	TYP.	MAX.	UNITS	CIRCUIT
Output Voltage (Accuracy±2%)	$V_{OUT(E)}^{(*2)}$	$V_{IN}=4.0V, I_{OUT}=20mA, V_{CE}=V_{IN}, V_{OFB}=V_{OUT}$	1.96	2.00	2.04	V	①
Output Voltage (Accuracy±1%)	$V_{OUT(E)}^{(*2)}$	$V_{IN}=4.0V, I_{OUT}=20mA, V_{CE}=V_{IN}, V_{OFB}=V_{OUT}$	1.98	2.00	2.02		
Divided Resistor	R_{FB}	$V_{IN}=V_{OUT}=5.0V, V_{CE}=V_{SS}, V_{OFB}=V_{OUT}$	1.70	4.10	6.30	MΩ	④
Maximum Output Current	I_{OUTMAX}	$V_{IN}=5.0V, V_{CE}=V_{IN}, V_{OFB}=V_{OUT}$	100	-	-	mA	①
Load Regulation	ΔV_{OUT}	$V_{IN}=4.0V, 1mA \leq I_{OUT} \leq 50mA, V_{CE}=V_{IN}, V_{OFB}=V_{OUT}$	-	50	90	mV	①
Dropout Voltage1	$V_{dif1}^{(*3)}$	$I_{OUT}=20mA, V_{CE}=V_{IN}, V_{OFB}=V_{OUT}$	-	450	600	mV	①
Dropout Voltage2	$V_{dif2}^{(*3)}$	$I_{OUT}=100mA, V_{CE}=V_{IN}, V_{OFB}=V_{OUT}$	-	1900	2600	mV	①
Supply Current	I_{SS}	$V_{IN}=4.0V, V_{CE}=V_{IN}, V_{OFB}=V_{OUT}$	1	5	9	μA	②
Stand-by Current	I_{STB}	$V_{IN}=4.0V, V_{CE}=V_{SS}, V_{OFB}=V_{OUT}$	-	0.01	0.10	μA	②
Line Regulation1	$\frac{\Delta V_{OUT}}{(\Delta V_{IN} \cdot V_{OUT})}$	$4.0V \leq V_{IN} \leq 28.0V, I_{OUT}=5mA, V_{CE}=V_{IN}, V_{OFB}=V_{OUT}$	-	0.05	0.10	%/V	①
Line Regulation2	$\frac{\Delta V_{OUT}}{(\Delta V_{IN} \cdot V_{OUT})}$	$4.0V \leq V_{IN} \leq 28.0V, I_{OUT}=13mA, V_{CE}=V_{IN}, V_{OFB}=V_{OUT}$	-	0.15	0.30	%/V	①
Input Voltage	V_{IN}		2.0	-	28.0	V	-
Output Voltage Temperature Characteristics	$\frac{\Delta V_{OUT}}{(\Delta T_{opr} \cdot V_{OUT})}$	$V_{IN}=4.0V, I_{OUT}=20mA, V_{CE}=V_{IN}, V_{OFB}=V_{OUT}, -40^{\circ}C \leq T_{opr} \leq 85^{\circ}C$	-	±100	-	ppm/°C	①
Power Supply Rejection Ratio	PSRR	$V_{IN}=4.0V+0.5Vp-pAC, I_{OUT}=20mA, f=1kHz, V_{CE}=V_{IN}, V_{OFB}=V_{OUT}$	-	30	-	dB	③
Short Current	I_{SHORT}	$V_{IN}=4.0V, V_{CE}=V_{IN}, V_{OFB}=V_{OUT}$	-	30	-	mA	①
CE "H" Level Voltage	V_{CEH}	$V_{IN}=4.0V, V_{OFB}=V_{OUT}$	1.1	-	28.0	V	①
CE "L" Level Voltage	V_{CEL}	$V_{IN}=4.0V, V_{OFB}=V_{OUT}$	0	-	0.35	V	①
CE "H" Level Current	I_{CEH}	$V_{IN}=V_{CE}=28.0V, V_{OFB}=V_{OUT}$	-0.1	-	0.1	μA	①
CE "L" Level Current	I_{CEL}	$V_{IN}=28.0V, V_{CE}=V_{SS}, V_{OFB}=V_{OUT}$	-0.1	-	0.1	μA	①
Thermal Shutdown Detect Temperature	T_{TSD}	$V_{IN}=4.0V, V_{CE}=V_{IN}$ Junction Temperature	-	150	-	°C	①
Thermal Shutdown Release Temperature	T_{TSR}	$V_{IN}=4.0V, V_{CE}=V_{IN}$ Junction Temperature	-	125	-	°C	①
Hysteresis Width	$T_{TSD}-T_{TSR}$	$V_{IN}=4.0V, V_{CE}=V_{IN}$ Junction Temperature	-	25	-	°C	-

NOTE:

*1: $V_{OUT(T)}$: Nominal output voltage C type is 2.0V.

*2: $V_{OUT(E)}$: Effective output voltage

(i.e. the output voltage when " $V_{OUT(T)}+2.0V$ " is provided at the V_{IN} pin while maintaining a certain I_{OUT} value.)

*3: $V_{dif}=(V_{IN1} - V_{OUT1})$

V_{OUT1} : $V_{OUT(T)} < 3.0V$, A voltage equal to 98% of the output voltage whenever an amply stabilized $I_{OUT}(V_{OUT(T)}+3.0V)$ is input.

$V_{OUT(T)} \geq 3.0V$, A voltage equal to 98% of the output voltage whenever an amply stabilized $I_{OUT}(V_{OUT(T)}+2.0V)$ is input.

V_{IN1} : The input voltage when V_{OUT1} appears as input voltage is gradually decreased.

■ ELECTRICAL CHARACTERISTICS (Continued)

● XC6216 Series D type

Ta=25°C

PARAMETER	SYMBOL	CONDITIONS	MIN.	TYP.	MAX.	UNITS	CIRCUIT
Output Voltage	V _{OUT(E)} ^(*)2)	I _{OUT} =20mA	E-0			V	①
Maximum Output Current	I _{OUTMAX}	V _{IN} =V _{OUT(T)} +3.0V ^(*)1) (V _{OUT(T)} ≥3.0V)	150	-	-	mA	①
		V _{IN} =V _{OUT(T)} +3.0V ^(*)1) (V _{OUT(T)} <3.0V)	100	-	-	mA	①
Load Regulation	ΔV _{OUT}	1mA≤I _{OUT} ≤50mA (1.8V≤V _{OUT(T)} ≤7.0V)	-	50	90	mV	①
		1mA≤I _{OUT} ≤50mA (7.0V<V _{OUT(T)} ≤12.0V)	-	110	140	mV	①
Dropout Voltage1	V _{dif1} ^(*)3)	I _{OUT} =20mA	-	E-1		mV	①
Dropout Voltage2	V _{dif2} ^(*)3)	I _{OUT} =100mA	-	E-2		mV	①
Supply Current	I _{SS}		1	5	9	μA	②
Line Regulation1	ΔV _{OUT} / (ΔV _{IN} · V _{OUT})	V _{OUT(T)} +2.0V≤V _{IN} ≤28.0V ^(*)1) I _{OUT} =5mA	-	0.05	0.10	%/V	①
Line Regulation2	ΔV _{OUT} / (ΔV _{IN} · V _{OUT})	V _{OUT(T)} +2.0V≤V _{IN} ≤28.0V ^(*)1) I _{OUT} =13mA	-	0.15	0.30	%/V	①
Input Voltage	V _{IN}		2.0	-	28.0	V	-
Output Voltage Temperature Characteristics	ΔV _{OUT} / (ΔT _{opr} · V _{OUT})	I _{OUT} =20mA -40°C≤T _{opr} ≤85°C	-	±100	-	ppm/°C	①
Power Supply Rejection Ratio	PSRR	V _{IN} =[V _{OUT(T)} +2.0]V+0.5Vp-pAC ^(*)1) I _{OUT} =20mA, f=1kHz	-	30	-	dB	③
Short Current	I _{SHORT}	V _{IN} =V _{OUT(T)} +2.0V ^(*)1)	-	30	-	mA	①
Thermal Shutdown Detect Temperature	T _{TSD}	Junction Temperature	-	150	-	°C	①
Thermal Shutdown Release Temperature	T _{TSR}	Junction Temperature	-	125	-	°C	①
Hysteresis Width	T _{TSD} -T _{TSR}	Junction Temperature	-	25	-	°C	-

Unless otherwise stated, V_{IN}=V_{OUT(T)}+2.0V.

NOTE:

*1: V_{OUT(T)}: Nominal output voltage

*2: V_{OUT(E)}: Effective output voltage

(i.e. the output voltage when "V_{OUT(T)}+2.0V" is provided at the V_{IN} pin while maintaining a certain I_{OUT} value.)

*3: V_{dif}={V_{IN1} - V_{OUT1} }

V_{OUT1}: V_{OUT(T)}<3.0V, A voltage equal to 98% of the output voltage whenever an amply stabilized I_{OUT}{V_{OUT(T)}+3.0V} is input.

V_{OUT1}≥3.0V, A voltage equal to 98% of the output voltage whenever an amply stabilized I_{OUT}{V_{OUT(T)}+2.0V} is input.

V_{IN1}: The input voltage when V_{OUT1} appears as input voltage is gradually decreased.

ELECTRICAL CHARACTERISTICS (Continued)

● Voltage Chart (XC6216 Series)

PARAMETER	E-0				E-1		E-2	
	OUTPUT VOLTAGE (V) 2% ACCURACY		OUTPUT VOLTAGE (V) 1% ACCURACY		DROPOUT VOLTAGE 1 (mV) $I_{OUT}=20mA$		DROPOUT VOLTAGE 2 (mV) $I_{OUT}=100mA$	
	$V_{OUT(E)}$		$V_{OUT(E)}$		V_{dif1}		V_{dif2}	
$V_{OUT(T)}$	MIN.	MAX.	MIN.	MAX.	TYP.	MAX.	TYP.	MAX.
1.8	1.764	1.836	1.780	1.820	550	710	2200	2700
1.9	1.862	1.938	1.880	1.920	550	710	2200	2700
2.0	1.960	2.040	1.980	2.020	450	600	1900	2600
2.1	2.058	2.142	2.079	2.121	450	600	1900	2600
2.2	2.156	2.244	2.178	2.222	390	520	1700	2200
2.3	2.254	2.346	2.277	2.323	390	520	1700	2200
2.4	2.352	2.448	2.376	2.424	390	520	1700	2200
2.5	2.450	2.550	2.475	2.525	310	450	1500	1900
2.6	2.548	2.652	2.574	2.626	310	450	1500	1900
2.7	2.646	2.754	2.673	2.727	310	450	1500	1900
2.8	2.744	2.856	2.772	2.828	310	450	1500	1900
2.9	2.842	2.958	2.871	2.929	310	450	1500	1900
3.0	2.940	3.060	2.970	3.030	260	360	1300	1700
3.1	3.038	3.162	3.069	3.131	260	360	1300	1700
3.2	3.136	3.264	3.168	3.232	260	360	1300	1700
3.3	3.234	3.366	3.267	3.333	260	360	1300	1700
3.4	3.332	3.468	3.366	3.434	260	360	1300	1700
3.5	3.430	3.570	3.465	3.535	260	360	1300	1700
3.6	3.528	3.672	3.564	3.636	260	360	1300	1700
3.7	3.626	3.774	3.663	3.737	260	360	1300	1700
3.8	3.724	3.876	3.762	3.838	260	360	1300	1700
3.9	3.822	3.978	3.861	3.939	260	360	1300	1700
4.0	3.920	4.080	3.960	4.040	220	320	1100	1500
4.1	4.018	4.182	4.059	4.141	220	320	1100	1500
4.2	4.116	4.284	4.158	4.242	220	320	1100	1500
4.3	4.214	4.386	4.257	4.343	220	320	1100	1500
4.4	4.312	4.488	4.356	4.444	220	320	1100	1500
4.5	4.410	4.590	4.455	4.545	220	320	1100	1500
4.6	4.508	4.692	4.554	4.646	220	320	1100	1500
4.7	4.606	4.794	4.653	4.747	220	320	1100	1500
4.8	4.704	4.896	4.752	4.848	220	320	1100	1500
4.9	4.802	4.998	4.851	4.949	220	320	1100	1500

■ ELECTRICAL CHARACTERISTICS (Continued)

● Voltage Chart (XC6216 Series) (Continued)

PARAMETER	E-0				E-1		E-2	
NOMINAL OUTPUT VOLTAGE(V)	OUTPUT VOLTAGE (V) 2% ACCURACY		OUTPUT VOLTAGE (V) 1% ACCURACY		DROPOUT VOLTAGE 1 (mV) I _{OUT} =20mA		DROPOUT VOLTAGE 2 (mV) I _{OUT} =100mA	
V _{OUT(T)}	V _{OUT(E)}		V _{OUT(E)}		V _{dif1}		V _{dif2}	
	MIN.	MAX.	MIN.	MAX.	TYP.	MAX.	TYP.	MAX.
5.0	4.900	5.100	4.950	5.050	190	280	1000	1300
5.1	4.998	5.202	5.049	5.151	190	280	1000	1300
5.2	5.096	5.304	5.148	5.252	190	280	1000	1300
5.3	5.194	5.406	5.247	5.353	190	280	1000	1300
5.4	5.292	5.508	5.346	5.454	190	280	1000	1300
5.5	5.390	5.610	5.445	5.555	190	280	1000	1300
5.6	5.488	5.712	5.544	5.656	190	280	1000	1300
5.7	5.586	5.814	5.643	5.757	190	280	1000	1300
5.8	5.684	5.916	5.742	5.916	190	280	1000	1300
5.9	5.782	6.018	5.841	5.959	190	280	1000	1300
6.0	5.880	6.120	5.940	6.060	190	280	1000	1300
6.1	5.978	6.222	6.039	6.161	190	280	1000	1300
6.2	6.076	6.324	6.138	6.262	190	280	1000	1300
6.3	6.174	6.426	6.237	6.363	190	280	1000	1300
6.4	6.272	6.528	6.336	6.464	190	280	1000	1300
6.5	6.370	6.630	6.435	6.565	170	230	800	1150
6.6	6.468	6.732	6.534	6.666	170	230	800	1150
6.7	6.566	6.834	6.633	6.767	170	230	800	1150
6.8	6.664	6.936	6.732	6.868	170	230	800	1150
6.9	6.762	7.038	6.831	6.969	170	230	800	1150
7.0	6.860	7.140	6.930	7.070	170	230	800	1150
7.1	6.958	7.242	7.029	7.171	170	230	800	1150
7.2	7.056	7.344	7.128	7.272	170	230	800	1150
7.3	7.154	7.446	7.227	7.373	170	230	800	1150
7.4	7.252	7.548	7.326	7.474	170	230	800	1150
7.5	7.350	7.650	7.425	7.575	170	230	800	1150
7.6	7.448	7.752	7.524	7.676	170	230	800	1150
7.7	7.546	7.854	7.623	7.777	170	230	800	1150
7.8	7.644	7.956	7.722	7.878	170	230	800	1150
7.9	7.742	8.058	7.821	7.979	170	230	800	1150
8.0	7.840	8.160	7.920	8.080	170	230	800	1150

■ ELECTRICAL CHARACTERISTICS (Continued)

● Voltage Chart (XC6216 Series) (Continued)

PARAMETER	E-0				E-1		E-2	
NOMINAL OUTPUT VOLTAGE(V)	OUTPUT VOLTAGE (V) 2% ACCURACY		OUTPUT VOLTAGE (V) 1% ACCURACY		DROPOUT VOLTAGE 1 (mV) $I_{OUT}=20mA$		DROPOUT VOLTAGE 2 (mV) $I_{OUT}=100mA$	
$V_{OUT(T)}$	$V_{OUT(E)}$		$V_{OUT(E)}$		V_{dif1}		V_{dif2}	
	MIN.	MAX.	MIN.	MAX.	TYP.	MAX.	TYP.	MAX.
8.1	7.938	8.262	8.019	8.181	130	190	700	950
8.2	8.036	8.364	8.118	8.282	130	190	700	950
8.3	8.134	8.466	8.217	8.383	130	190	700	950
8.4	8.232	8.568	8.316	8.484	130	190	700	950
8.5	8.330	8.670	8.415	8.585	130	190	700	950
8.6	8.428	8.772	8.514	8.686	130	190	700	950
8.7	8.526	8.874	8.613	8.787	130	190	700	950
8.8	8.624	8.976	8.712	8.888	130	190	700	950
8.9	8.722	9.078	8.811	8.989	130	190	700	950
9.0	8.820	9.180	8.910	9.090	130	190	700	950
9.1	8.918	9.282	9.009	9.191	130	190	700	950
9.2	9.016	9.384	9.108	9.292	130	190	700	950
9.3	9.114	9.486	9.207	9.393	130	190	700	950
9.4	9.212	9.588	9.306	9.494	130	190	700	950
9.5	9.310	9.690	9.405	9.595	130	190	700	950
9.6	9.408	9.792	9.504	9.696	130	190	700	950
9.7	9.506	9.894	9.603	9.797	130	190	700	950
9.8	9.604	9.996	9.702	9.898	130	190	700	950
9.9	9.702	10.098	9.801	9.999	130	190	700	950
10.0	9.800	10.200	9.900	10.100	130	190	700	950
10.1	9.898	10.302	9.999	10.201	120	160	650	850
10.2	9.996	10.404	10.098	10.302	120	160	650	850
10.3	10.094	10.506	10.197	10.403	120	160	650	850
10.4	10.192	10.608	10.296	10.504	120	160	650	850
10.5	10.290	10.710	10.395	10.605	120	160	650	850
10.6	10.388	10.812	10.494	10.706	120	160	650	850
10.7	10.486	10.914	10.593	10.807	120	160	650	850
10.8	10.584	11.016	10.692	10.908	120	160	650	850
10.9	10.682	11.118	10.791	11.009	120	160	650	850
11.0	10.780	11.220	10.890	11.110	120	160	650	850
11.1	10.878	11.322	10.989	11.211	120	160	650	850
11.2	10.976	11.424	11.088	11.312	120	160	650	850
11.3	11.074	11.526	11.187	11.413	120	160	650	850
11.4	11.172	11.628	11.286	11.514	120	160	650	850
11.5	11.270	11.730	11.385	11.615	120	160	650	850
11.6	11.368	11.832	11.484	11.716	120	160	650	850
11.7	11.466	11.934	11.583	11.817	120	160	650	850
11.8	11.564	12.036	11.682	11.918	120	160	650	850
11.9	11.662	12.138	11.781	12.019	120	160	650	850
12.0	11.760	12.240	11.880	12.120	120	160	650	850

■ ELECTRICAL CHARACTERISTICS (Continued)

● XE6216 Series B Type

PARAMETER	SYMBOL	CONDITIONS	Ta=25°C			Ta=-40°C ~ 85°C			UNITS	CIRCUIT
			MIN.	TYP.	MAX.	MIN.	TYP.	MAX.		
Output Voltage	$V_{OUT(E)}^{(*)2}$	$I_{OUT}=20mA, V_{CE}=V_{IN}$	E-0-1			E-0-2			V	①
Maximum Output Current ^(*)	I_{OUTMAX}	$V_{IN}=V_{OUT(T)}+3.0V, V_{CE}=V_{IN}^{(*)1}$ ($V_{OUT(T)} \geq 3.0V$)	-	-	-	150	-	-	mA	①
		$V_{IN}=V_{OUT(T)}+3.0V, V_{CE}=V_{IN}^{(*)1}$ ($V_{OUT(T)} < 3.0V$)	-	-	-	100	-	-	mA	①
Load Regulation ^(*)	ΔV_{OUT}	$V_{CE}=V_{IN}, 1mA \leq I_{OUT} \leq 50mA$	-	E-1-1		-	E-1-2		mV	①
Dropout Voltage1	$V_{dif1}^{(*)3}$	$I_{OUT}=20mA, V_{CE}=V_{IN}$	-	E-2-1		-	E-2-2		mV	①
Dropout Voltage2 ^(*)	$V_{dif2}^{(*)3}$	$I_{OUT}=100mA, V_{CE}=V_{IN}$	-	E-3-1		-	E-3-2		mV	①
Supply Current	I_{SS}	$V_{CE}=V_{IN}$	1	5	9	0.5	5	10	μA	②
Stand-by Current	I_{STB}	$V_{CE}=V_{SS}$	-	0.01	0.1	-	0.01	4	μA	②
Line Regulation1 ^(*)	$\frac{\Delta V_{OUT}}{(\Delta V_{IN} \cdot V_{OUT})}$	$V_{OUT(T)}+2.0V \leq V_{IN} \leq 28.0V^{(*)1}$ $I_{OUT}=5mA, V_{CE}=V_{IN}$	-	0.05	0.10	-	0.05	0.12	%/V	①
Line Regulation2 ^(*)	$\frac{\Delta V_{OUT}}{(\Delta V_{IN} \cdot V_{OUT})}$	$V_{OUT(T)}+2.0V \leq V_{IN} \leq 28.0V^{(*)1}$ $I_{OUT}=13mA, V_{CE}=V_{IN}$	-	0.15	0.30	-	0.15	0.32	%/V	①
Input Voltage	V_{IN}		2.0		28.0	2.0		28.0	V	
Output Voltage Temperature Characteristics	$\frac{\Delta V_{OUT}}{(\Delta T_{opr} \cdot V_{OUT})}$	$I_{OUT}=20mA, V_{CE}=V_{IN}$ $-40^{\circ}C \leq T_{opr} \leq 85^{\circ}C$	-	± 100	± 350	-	-	-	ppm/ $^{\circ}C$	①
Power Supply Rejection Ratio	PSRR	$V_{IN}=[V_{OUT(T)}+2.0]V+0.5Vp-pAC^{(*)1}$ $I_{OUT}=20mA, f=1kHz, V_{CE}=V_{IN}$	-	30	-	-	30	-	dB	③
Short Current	I_{SHORT}	$V_{CE}=V_{IN}$	-	30	-	-	30	-	mA	①
CE "H" Level Voltage	V_{CEH}	-	-	-	-	1.1	-	28.0	V	①
CE "L" Level Voltage	V_{CEL}	-	-	-	-	0	-	0.35	V	①
CE "H" Level Current	I_{CEH}	$V_{IN}=V_{CE}=28.0V$	-0.1	-	0.1	-0.1	-	0.7	μA	②
CE "L" Level Current	I_{CEL}	$V_{IN}=28.0V, V_{CE}=V_{SS}$	-0.1	-	0.1	-0.2	-	-0.2	μA	②
Thermal Shutdown Detect Temperature	T_{TSD}	$V_{CE}=V_{IN}$, Junction Temperature	-	150	-	-	150	-	$^{\circ}C$	①
Thermal Shutdown Release Temperature	T_{TSR}	$V_{CE}=V_{IN}$, Junction Temperature	-	125	-	-	125	-	$^{\circ}C$	①
Hysteresis Width	$T_{TSD} - T_{TSR}$	$V_{CE}=V_{IN}$, Junction Temperature	-	25	-	-	25	-	$^{\circ}C$	-

Unless otherwise stated, $V_{IN}=V_{OUT(T)}+2.0V$.

NOTE:

*1: $V_{OUT(T)}$: Nominal output voltage

*2: $V_{OUT(E)}$: Effective output voltage

(i.e. the output voltage when " $V_{OUT(T)}+2.0V$ " is provided at the V_{IN} pin while maintaining a certain I_{OUT} value.)

*3: $V_{dif}=\{V_{IN1} - V_{OUT1}\}$

V_{OUT1} : $V_{OUT(T)} < 3.0V$, A voltage equal to 98% of the output voltage whenever an amply stabilized $I_{OUT}\{V_{OUT(T)}+3.0V\}$ is input.

$V_{OUT(T)} \geq 3.0V$, A voltage equal to 98% of the output voltage whenever an amply stabilized $I_{OUT}\{V_{OUT(T)}+2.0V\}$ is input.

V_{IN1} : The input voltage when V_{OUT1} appears as input voltage is gradually decreased.

(*) Junction temperature range is $T_j=-40 \sim 125^{\circ}C$ for this table.

■ ELECTRICAL CHARACTERISTICS (Continued)

● Voltage Chart 1 (XE6216 Series)

MBOL	E-0-1		E-0-2	
Temperature / Ta	25°C		-40 ~ 85°C	
PARAMETER	OUTPUT VOLTAGE (V) Accuracy ±2%		OUTPUT VOLTAGE (V) Accuracy +3%, -3.5%	
NOMINAL OUTPUT VOLTAGE(V)	V _{OUT(E)}		V _{OUT(E)}	
V _{OUT(T)}	MIN.	MAX.	MIN.	MAX.
2.0	1.960	2.040	1.930	2.060
2.1	2.058	2.142	2.027	2.163
2.2	2.156	2.244	2.123	2.266
2.3	2.254	2.346	2.220	2.369
2.4	2.352	2.448	2.316	2.472
2.5	2.450	2.550	2.413	2.575
2.6	2.548	2.652	2.509	2.678
2.7	2.646	2.754	2.606	2.781
2.8	2.744	2.856	2.702	2.884
2.9	2.842	2.958	2.799	2.987
3.0	2.940	3.060	2.895	3.090
3.1	3.038	3.162	2.992	3.193
3.2	3.136	3.264	3.088	3.296
3.3	3.234	3.366	3.185	3.399
3.4	3.332	3.468	3.281	3.502
3.5	3.430	3.570	3.378	3.605
3.6	3.528	3.672	3.474	3.708
3.7	3.626	3.774	3.571	3.811
3.8	3.724	3.876	3.667	3.914
3.9	3.822	3.978	3.764	4.017
4.0	3.920	4.080	3.860	4.120
4.1	4.018	4.182	3.957	4.223
4.2	4.116	4.284	4.053	4.326
4.3	4.214	4.386	4.150	4.429
4.4	4.312	4.488	4.246	4.532
4.5	4.410	4.590	4.342	4.635
4.6	4.508	4.692	4.439	4.738
4.7	4.606	4.794	4.535	4.841
4.8	4.704	4.896	4.632	4.944
4.9	4.802	4.998	4.728	5.047

SYMBOL	E-0-1		E-0-2	
Temperature / Ta	25°C		-40 ~ 85°C	
PARAMETER	OUTPUT VOLTAGE (V) Accuracy ±2%		OUTPUT VOLTAGE (V) Accuracy +3%, -3.5%	
NOMINAL OUTPUT VOLTAGE(V)	V _{OUT(E)}		V _{OUT(E)}	
V _{OUT(T)}	MIN.	MAX.	MIN.	MAX.
5.0	4.900	5.100	4.825	5.150
5.1	4.998	5.202	4.921	5.253
5.2	5.096	5.304	5.018	5.356
5.3	5.194	5.406	5.114	5.459
5.4	5.292	5.508	5.211	5.562
5.5	5.390	5.610	5.307	5.665
5.6	5.488	5.712	5.404	5.768
5.7	5.586	5.814	5.500	5.871
5.8	5.684	5.916	5.597	5.974
5.9	5.782	6.018	5.693	6.077
6.0	5.880	6.120	5.790	6.180
6.1	5.978	6.222	5.886	6.283
6.2	6.076	6.324	5.983	6.386
6.3	6.174	6.426	6.079	6.489
6.4	6.272	6.528	6.176	6.592
6.5	6.370	6.630	6.272	6.695
6.6	6.468	6.732	6.369	6.798
6.7	6.566	6.834	6.465	6.901
6.8	6.664	6.936	6.562	7.004
6.9	6.762	7.038	6.658	7.107
7.0	6.860	7.140	6.755	7.210
7.1	6.958	7.242	6.851	7.313
7.2	7.056	7.344	6.948	7.416
7.3	7.154	7.446	7.044	7.519
7.4	7.252	7.548	7.141	7.622
7.5	7.350	7.650	7.237	7.725
7.6	7.448	7.752	7.334	7.828
7.7	7.546	7.854	7.430	7.931
7.8	7.644	7.956	7.527	8.034
7.9	7.742	8.058	7.623	8.137

■ ELECTRICAL CHARACTERISTICS (Continued)

● Voltage Chart 2 (XE6216 Series)

SYMBOL	E-0-1		E-0-2	
Temperature /Ta	25°C		-40 ~ 85°C	
PARAMETER	OUTPUT VOLTAGE (V) Accuracy ±2%		OUTPUT VOLTAGE (V) Accuracy +3% , -3.5%	
NOMINAL OUTPUT VOLTAGE(V)	V _{OUT(E)}		V _{OUT(E)}	
V _{OUT(T)}	MIN.	MAX.	MIN.	MAX.
8.0	7.840	8.160	7.720	8.240
8.1	7.938	8.262	7.816	8.343
8.2	8.036	8.364	7.913	8.446
8.3	8.134	8.466	8.009	8.549
8.4	8.232	8.568	8.106	8.652
8.5	8.330	8.670	8.202	8.755
8.6	8.428	8.772	8.299	8.858
8.7	8.526	8.874	8.395	8.961
8.8	8.624	8.976	8.492	9.064
8.9	8.722	9.078	8.588	9.167
9.0	8.820	9.180	8.685	9.270
9.1	8.918	9.282	8.781	9.373
9.2	9.016	9.384	8.878	9.476
9.3	9.114	9.486	8.974	9.579
9.4	9.212	9.588	9.071	9.682
9.5	9.310	9.690	9.167	9.785
9.6	9.408	9.792	9.264	9.888
9.7	9.506	9.894	9.360	9.991
9.8	9.604	9.996	9.457	10.094
9.9	9.702	10.098	9.553	10.197
10.0	9.800	10.200	9.650	10.300
10.1	9.898	10.302	9.747	10.403
10.2	9.996	10.404	9.843	10.506
10.3	10.094	10.506	9.940	10.609
10.4	10.192	10.608	10.036	10.712
10.5	10.290	10.710	10.133	10.815
10.6	10.388	10.812	10.229	10.918
10.7	10.486	10.914	10.326	11.021
10.8	10.584	11.016	10.422	11.124
10.9	10.682	11.118	10.519	11.227
11.0	10.780	11.220	10.615	11.330
11.1	10.878	11.322	10.712	11.433
11.2	10.976	11.424	10.808	11.536
11.3	11.074	11.526	10.905	11.639
11.4	11.172	11.628	11.001	11.742
11.5	11.270	11.730	11.098	11.845
11.6	11.368	11.832	11.194	11.948
11.7	11.466	11.934	11.291	12.051
11.8	11.564	12.036	11.387	12.154
11.9	11.662	12.138	11.484	12.257
12.0	11.760	12.240	11.580	12.360

■ ELECTRICAL CHARACTERISTICS (Continued)

● Voltage Chart 3 (XE6216 Series)

SYMBOL	E-1-1		E-1-2		E-2-1		E-2-2		E-3-1		E-3-2	
Temperature /Ta	25°C		-40 ~ 85°C		25°C		-40 ~ 85°C		25°C		-40 ~ 85°C	
PARAMETER	LOAD REGULATION (mV)		LOAD REGULATION (mV)		DROPOUT VOLTAGE 1 (mV) I _{OUT} =20mA		DROPOUT VOLTAGE 1 (mV) I _{OUT} =20mA		DROPOUT VOLTAGE 2 (mV) I _{OUT} =100mA		DROPOUT VOLTAGE 2 (mV) I _{OUT} =100mA	
NOMINAL OUTPUT VOLTAGE(V)	ΔV _{OUT}		ΔV _{OUT}		V _{dif1}		V _{dif1}		V _{dif2}		V _{dif2}	
V _{OUT(T)} (V)	TYP.	MAX.	TYP.	MAX.	TYP.	MAX.	TYP.	MAX.	TYP.	MAX.	TYP.	MAX.
2.0	50	90	50	103	450	600	450	735	1900	2600	1900	3060
2.1					390	520	390	675	1700	2200	1700	2760
2.2					310	450	310	620	1500	1900	1500	2620
2.3												
2.4					260	360	260	520	1300	1700	1300	2370
2.5												
2.6												
2.7												
2.8												
2.9												
3.0												
3.1												
3.2												
3.3												
3.4					220	320	220	410	1100	1500	1100	2045
3.5												
3.6												
3.7												
3.8												
3.9												
4.0	220	320	220	410	1100	1500	1100	2045				
4.1												
4.2												
4.3												
4.4												
4.5	220	320	220	410	1100	1500	1100	2045				
4.6												
4.7												
4.8												
4.9	220	320	220	410	1100	1500	1100	2045				

■ ELECTRICAL CHARACTERISTICS (Continued)

● Voltage Chart 4 (XE6216 Series)

SYMBOL	E-1-1		E-1-2		E-2-1		E-2-2		E-3-1		E-3-2	
Temperature / Ta	25°C		-40 ~ 85°C		25°C		-40 ~ 85°C		25°C		-40 ~ 85°C	
PARAMETER	LOAD REGULATION (mV)		LOAD REGULATION (mV)		DROPOUT VOLTAGE 1 (mV) I _{OUT} =20mA		DROPOUT VOLTAGE 1 (mV) I _{OUT} =20mA		DROPOUT VOLTAGE 2 (mV) I _{OUT} =100mA		DROPOUT VOLTAGE 2 (mV) I _{OUT} =100mA	
NOMINAL OUTPUT VOLTAGE(V)	ΔV _{OUT}		ΔV _{OUT}		V _{dif1}		V _{dif1}		V _{dif2}		V _{dif2}	
V _{OUT(T)} (V)	TYP.	MAX.	TYP.	MAX.	TYP.	MAX.	TYP.	MAX.	TYP.	MAX.	TYP.	MAX.
5.0												
5.1												
5.2												
5.3												
5.4												
5.5												
5.6												
5.7					190	280	190	380	1000	1300	1000	1730
5.8												
5.9												
6.0	50	90	50	103								
6.1												
6.2												
6.3												
6.4												
6.5												
6.6												
6.7												
6.8												
6.9												
7.0												
7.1												
7.2					170	230	170	340	800	1150	800	1580
7.3												
7.4												
7.5	110	140	110	150								
7.6												
7.7												
7.8												
7.9												
8.0												

XC6216/XE6216 Series

ELECTRICAL CHARACTERISTICS (Continued)

● Voltage Chart 5 (XE6216 Series)

SYMBOL	E-1-1		E-1-2		E-2-1		E-2-2		E-3-1		E-3-2	
Temperature / Ta	25°C		-40 ~ 85°C		25°C		-40 ~ 85°C		25°C		-40 ~ 85°C	
PARAMETER	LOAD REGULATION (mV)		LOAD REGULATION (mV)		DROPOUT VOLTAGE 1 (mV) I _{OUT} =20mA		DROPOUT VOLTAGE 1 (mV) I _{OUT} =20mA		DROPOUT VOLTAGE 2 (mV) I _{OUT} =100mA		DROPOUT VOLTAGE 2 (mV) I _{OUT} =100mA	
NOMINAL OUTPUT VOLTAGE(V)	ΔV _{OUT}		ΔV _{OUT}		V _{dif1}		V _{dif1}		V _{dif2}		V _{dif2}	
V _{OUT(T)} (V)	TYP.	MAX.	TYP.	MAX.	TYP.	MAX.	TYP.	MAX.	TYP.	MAX.	TYP.	MAX.
8.1												
8.2												
8.3												
8.4												
8.5												
8.6												
8.7												
8.8												
8.9												
9.0					130	190	130	320	700	950	700	1460
9.1												
9.2												
9.3												
9.4												
9.5												
9.6												
9.7												
9.8												
9.9												
10.0	110	140	110	150								
10.1												
10.2												
10.3												
10.4												
10.5												
10.6												
10.7												
10.8												
10.9												
11.0					120	160	120	285	650	850	650	1160
11.1												
11.2												
11.3												
11.4												
11.5												
11.6												
11.7												
11.8												
11.9												
12.0												

TEST CIRCUITS

Circuit ①

●XC6216B/XE6216B Type

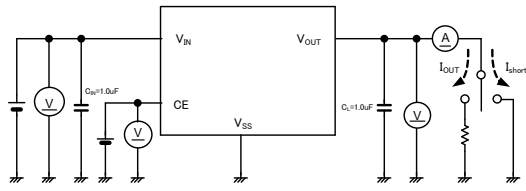

●XC6216C Type

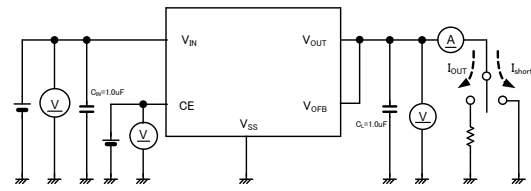

●XC6216D Type

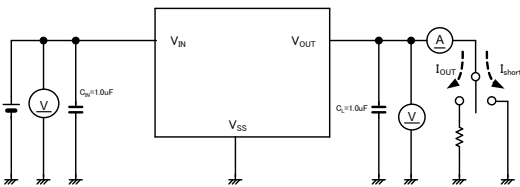

Circuit ②

●XC6216B/XE6216B Type

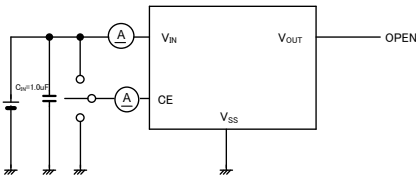

●XC6216C Type

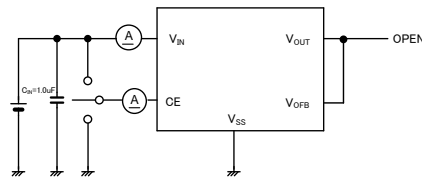

●XC6216D Type

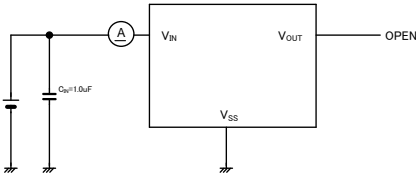

Circuit ③

●XC6216B/XE6216B Type

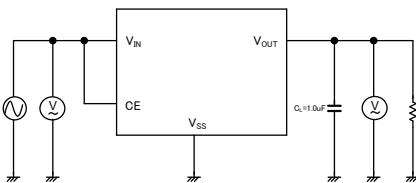

●XC6216C Type

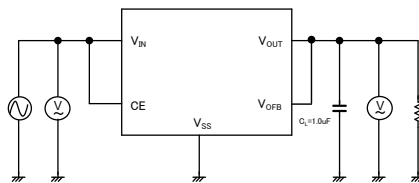

●XC6216D Type

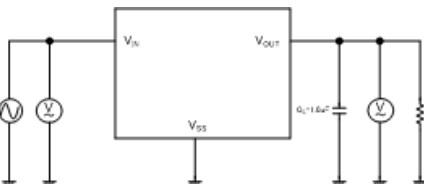

Circuit ④

●XC6216C Type

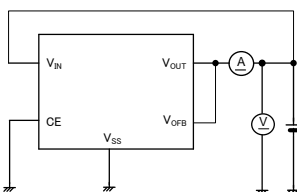

OPERATIONAL EXPLANATION

<Output Voltage Control>

The voltage divided by resistors R11 & R12 is compared with the internal reference voltage by the error amplifier. The P-channel MOSFET which is connected to the V_{OUT} pin is then driven by the subsequent controlled signal. The output voltage at the V_{OUT} pin is controlled and stabilized by a system of negative feedback. The current limit circuit and short protect circuit operate in relation to the level of output current and heat dissipation. Further, the IC's internal circuitry can be shutdown via the CE pin's signal.

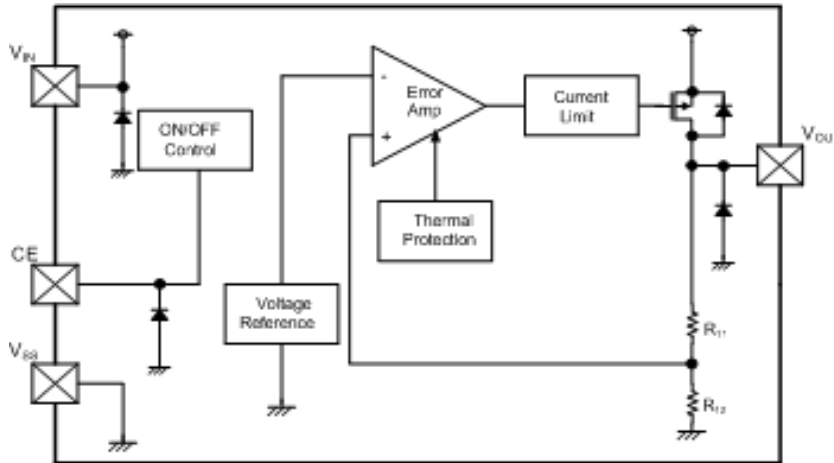

<Short-Circuit Protection>

The XC6216/XE6216 series includes a current fold-back circuit as a short circuit protection. When the load current reaches the current limit level, the current fold-back circuit operates and output voltage drops. The output voltage drops further and output current decreases. When the output pin is shorted, a current of about 30mA flows.

<CE Pin>

The IC's internal circuitry can be shutdown via the signal from the CE pin with the XC6216/XE6216 series. In shutdown mode, output at the V_{OUT} pin will be pulled down by R11 and R12 to the V_{SS} level. Note that as the XC6216/XE6216 series has no pull down resistor so that it will become unstable with the CE pin open. We suggest that you use this IC with either a V_{IN} voltage or a V_{SS} voltage input at the CE pin. If this IC is used with the correct specifications for the CE pin, the operational logic is fixed and the IC will operate normally. However, supply current may increase as a result of through current in the IC's internal circuitry if a medium voltage is applied.

<Thermal Protection>

When the junction temperature of the built-in driver transistor reaches the temperature limit, the thermal shutdown circuit operates and the driver transistor will be set to OFF. The IC resumes its operation when the thermal shutdown function is released and the IC's operation is automatically restored because the junction temperature drops to the level of the thermal shutdown release voltage.

<Minimum Operating Voltage>

For the stable operation of the IC, over 2.0V of input voltage is necessary. The output voltage may not be generated normally if the input voltage is less than 2.0V.

NOTES ON USE

1. Please use this IC within the stated absolute maximum ratings. The IC is liable to malfunction should the ratings be exceeded.
2. Where wiring impedance is high, operations may become unstable due to the noise and/or phase lag depending on output current. Please strengthen V_{IN} and V_{SS} wiring in particular.
3. Phase compensation inside the IC is performed in the XC6216/XE6216 series. Therefore, an abnormal oscillation does not occur even if there is no output capacitor C_L. An input capacitor C_{IN} around 0.1 μ F~1.0 μ F between the power input pin (V_{IN}) and the ground pin (V_{SS}) is required for input stability. Also, the output voltage fluctuation such as under shoot or over shoot, which occurs because of the load change can be controlled by placing the output capacitor C_L around 0.1 μ F~1.0 μ F between the V_{OUT} pin and V_{SS} pin. The input capacitor (C_{IN}) and the output capacitor (C_L) should be placed to the IC as close as possible with a shorter wiring.

NOTES ON USE

4. Notes on setting output voltage externally (C type) $T_a=25^\circ\text{C}$

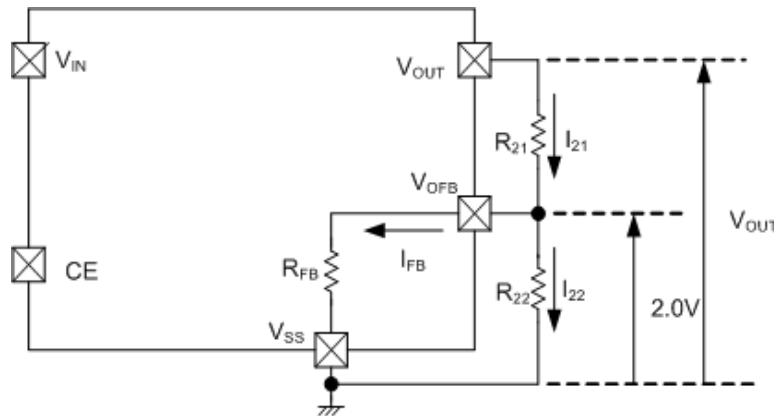

The output voltage can be set externally by the following equation:

$$I_{21} = I_{FB} + I_{22} \quad \dots \dots \dots (1)$$

$$I_{22} = 2.0V / R_{22} \quad \dots \dots \dots (2)$$

$$I_{21} = I_{FB} + 2.0V / R_{22} \quad \dots \dots \dots (3)$$

If the equation (3) is assigned to the equation (2), the equation becomes as below:

$$V_{OUT} = 2.0V + R_{21} \cdot I_{21} \quad \dots \dots \dots (3)$$

For this, the following equation can be used for setting output voltage externally:

$$V_{OUT} = 2.0V + R_{21} \cdot I_{21} \quad \dots \dots \dots (4)$$

And the equation (4) will be;

$$\begin{aligned} V_{OUT} &= 2.0V + R_{21} \cdot (I_{FB} + 2.0V / R_{22}) \quad \dots \dots \dots (5) \\ &= 2.0V \cdot (R_{21} + R_{22}) / R_{22} + R_{21} \cdot I_{FB} \end{aligned}$$

The second term of the equation (6), $R_{21} \cdot I_{FB}$, is the cause of the output accuracy error.

The I_{FB} can be calculated by the following equation:

$$I_{FB} = 2.0V / R_{FB} \quad \dots \dots \dots (6)$$

The cause of the output accuracy error, $R_{21} \cdot I_{FB}$ can be calculated by the equation below;

$$\begin{aligned} R_{21} \cdot I_{FB} &= R_{21} \cdot 2.0V / R_{FB} \quad \dots \dots \dots (7) \\ &= 2.0V \cdot R_{21} / R_{FB} \end{aligned}$$

Accordingly, if $R_{21} \ll R_{FB}$, the output voltage error becomes minute.

● Setting Resistance-Dependent of XC6216 Series C type's Output Voltage

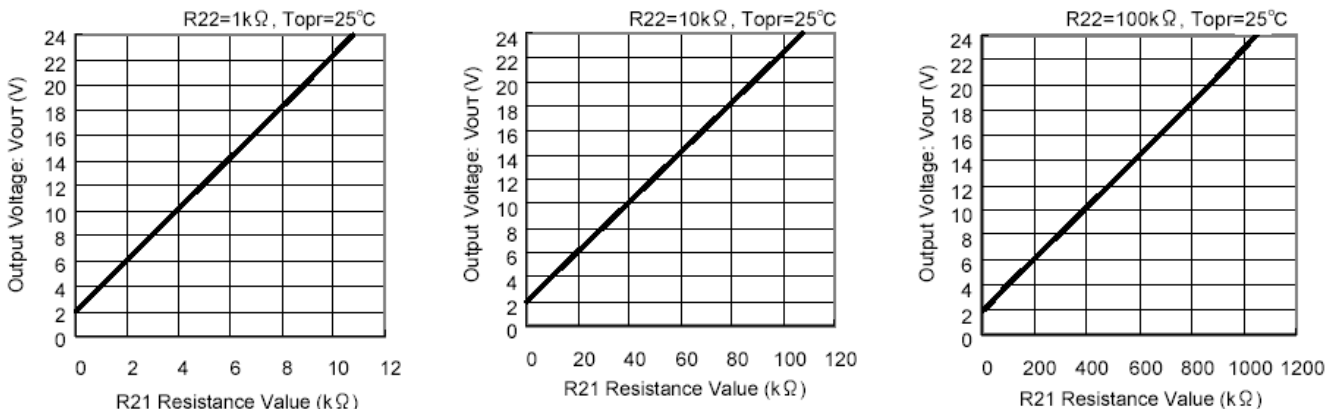

5. Torex places an importance on improving our products and its reliability. However, by any possibility, we would request user fail-safe design and post-aging treatment on system or equipment.

TYPICAL PERFORMANCE CHARACTERISTICS

(1) Output Voltage vs. Output Current

XC6216B/C/D 202

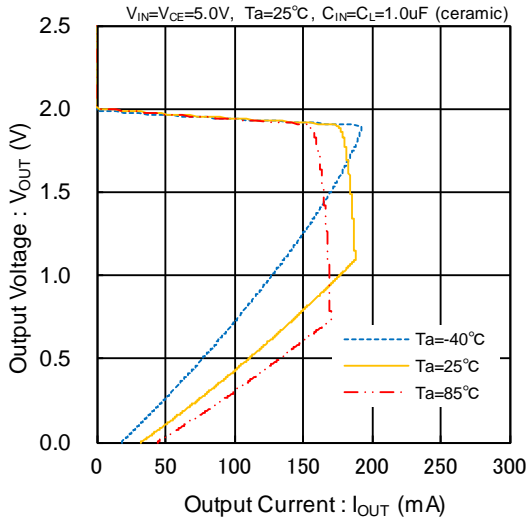

XC6216B/C/D 202

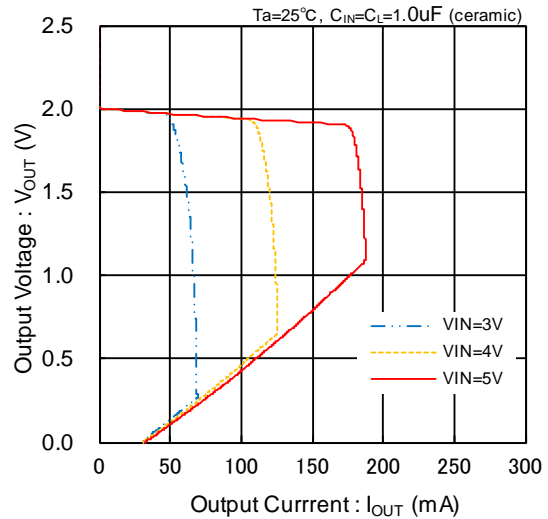

XC6216B/D 332

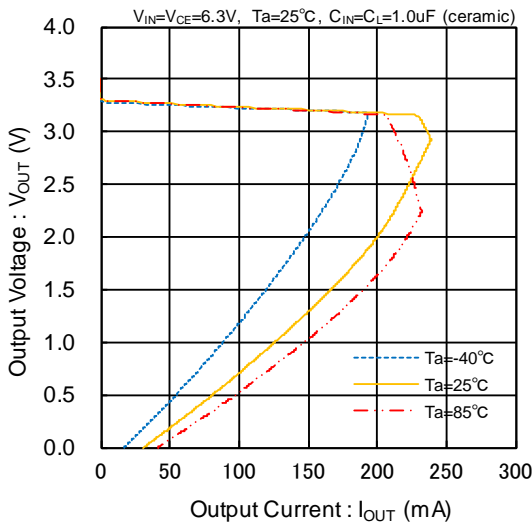

XC6216B/D 332

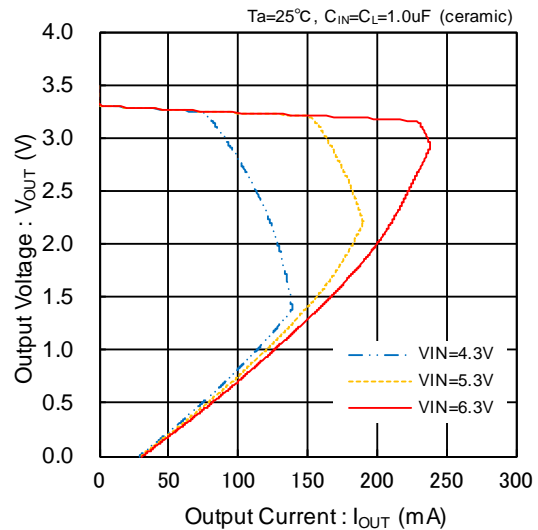

XC6216B/D 502

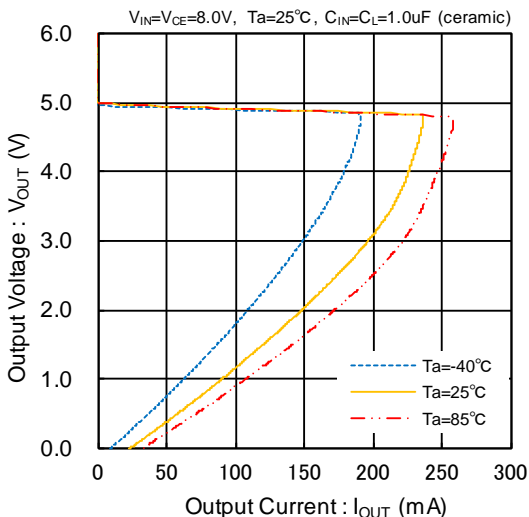

XC6216B/D 502

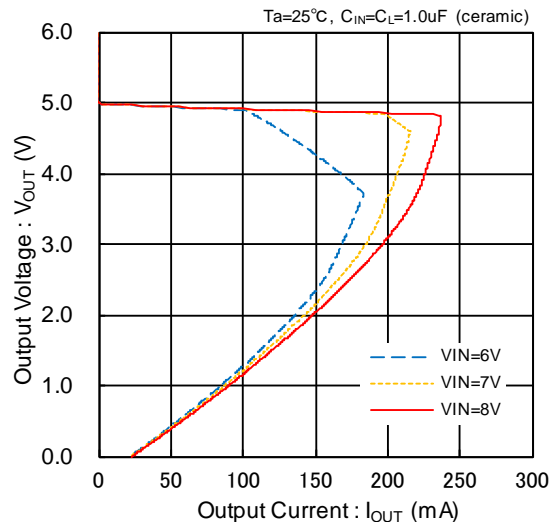

■ TYPICAL PERFORMANCE CHARACTERISTICS (Continued)

(1) Output Voltage vs. Output Current (Continued)

XC6216B/D C02



XC6216B/D C02

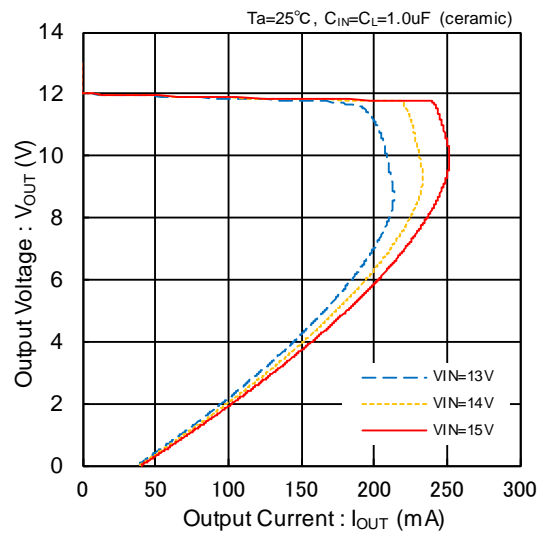

(2) Output Voltage vs. Input Voltage

XC6216B/C/D 202



XC6216B/C/D 202



XC6216B/D 332

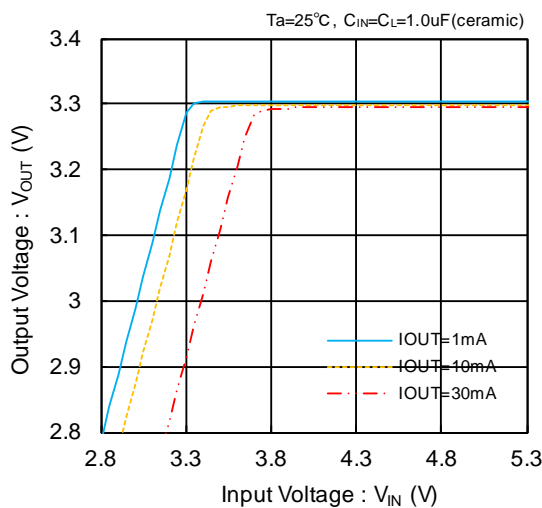

XC6216B/D 332

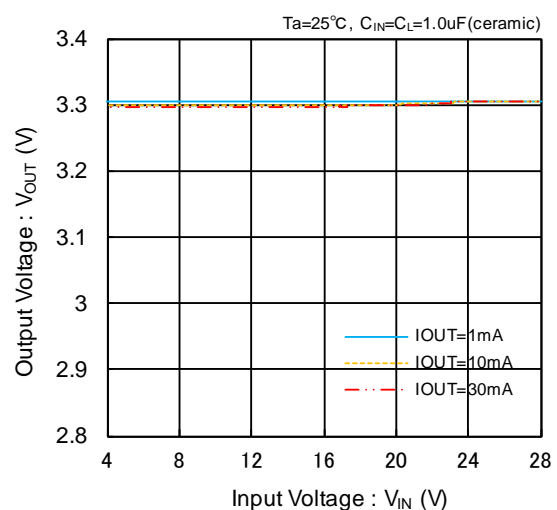

TYPICAL PERFORMANCE CHARACTERISTICS (Continued)

(2) Output Voltage vs. Input Voltage (Continued)

XC6216B/D 502

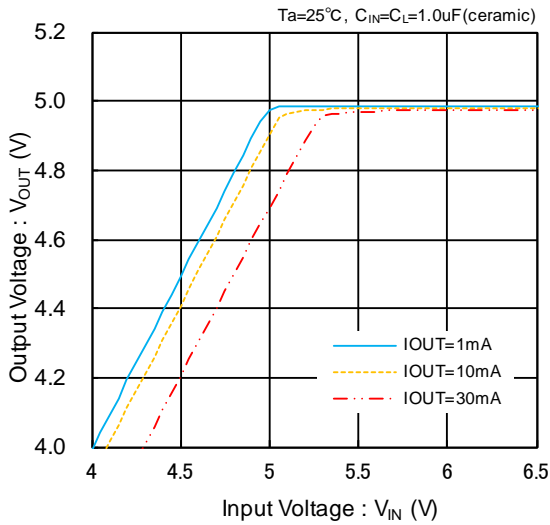

XC6216B/D 502

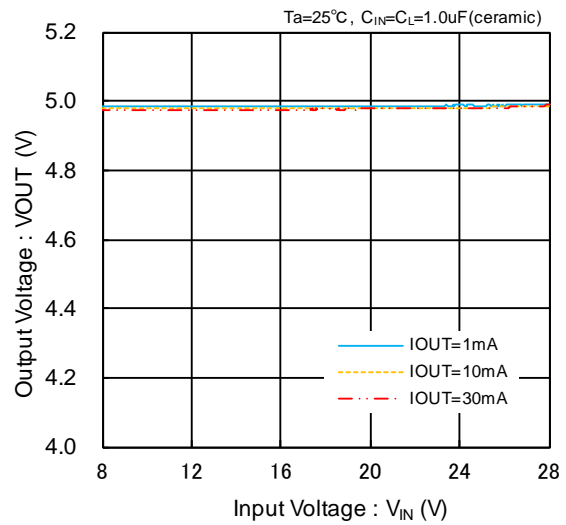

XC6216B/D C02

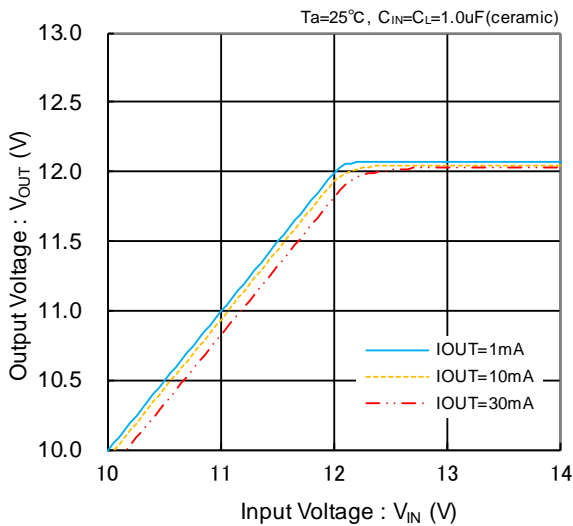

XC6216B/D C02

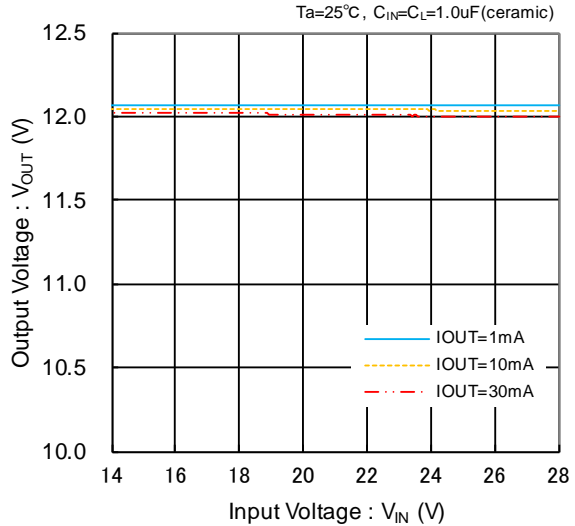

(3) Dropout Voltage vs. Output Current

XC6216B/C/D 202

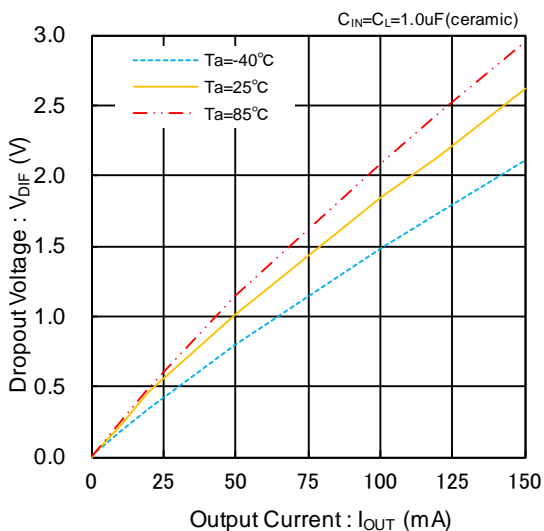

XC6216B/D 332

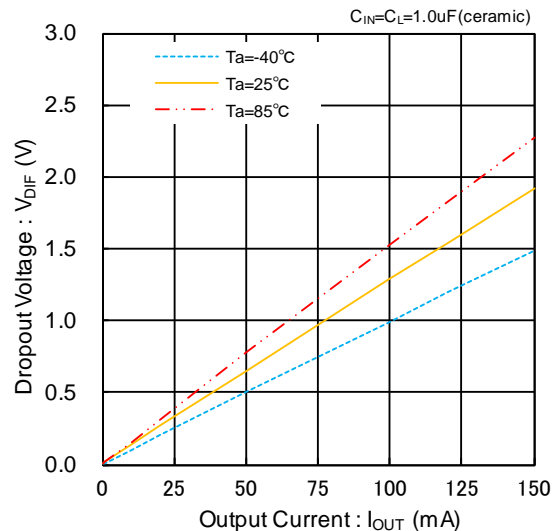

TYPICAL PERFORMANCE CHARACTERISTICS (Continued)

(3) Dropout Voltage vs. Output Current (Continued)

XC6216B/D 502

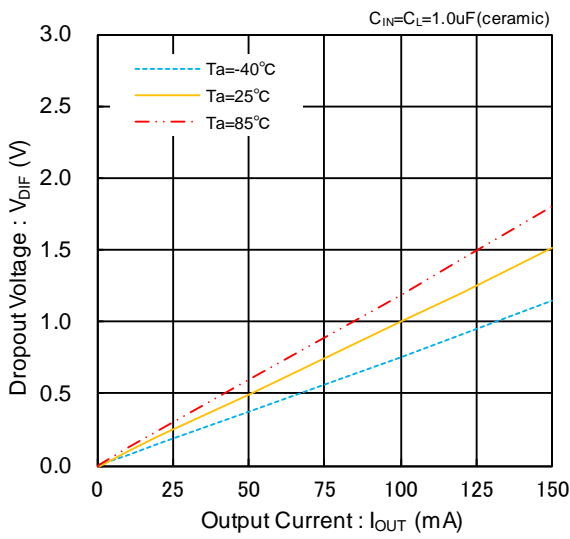

XC6216B/D C02

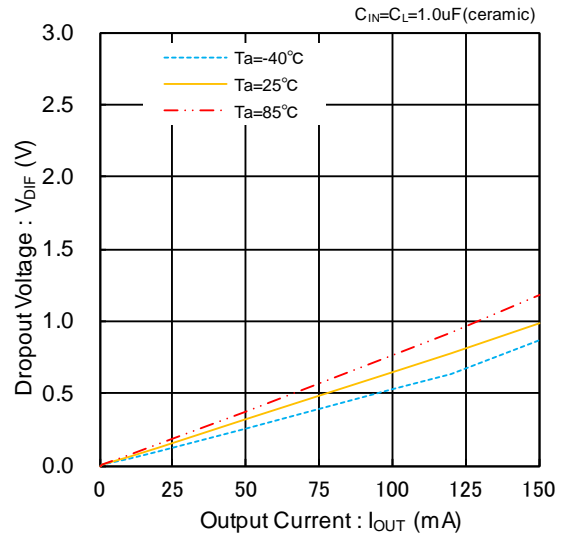

(4) Supply Current vs. Input Voltage

XC6216B/C/D 202

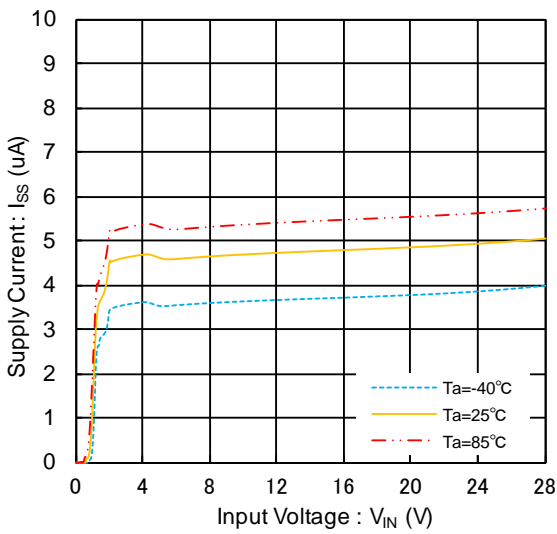

XC6216B/C/D 202

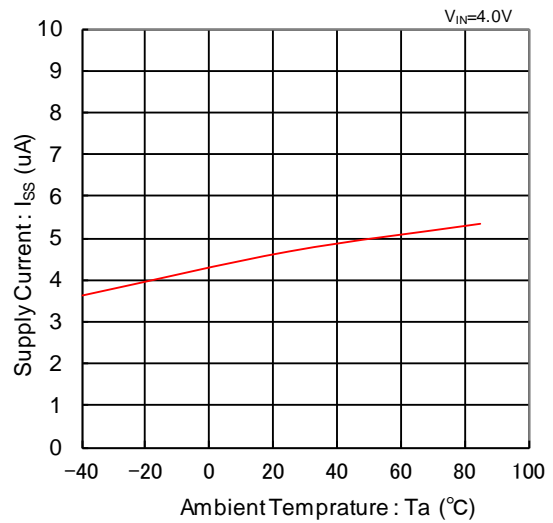

XC6216B/D 332

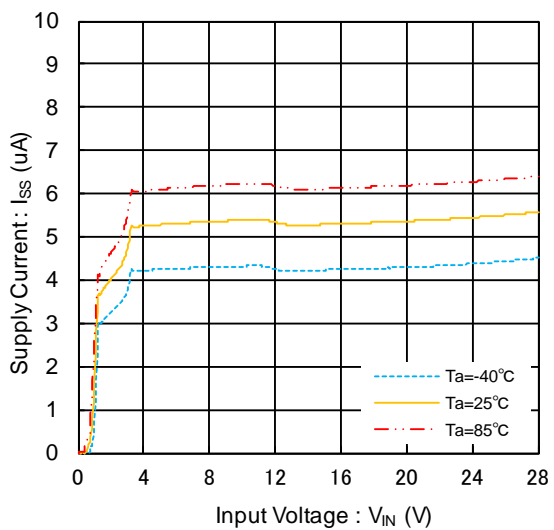

XC6216B/D 332

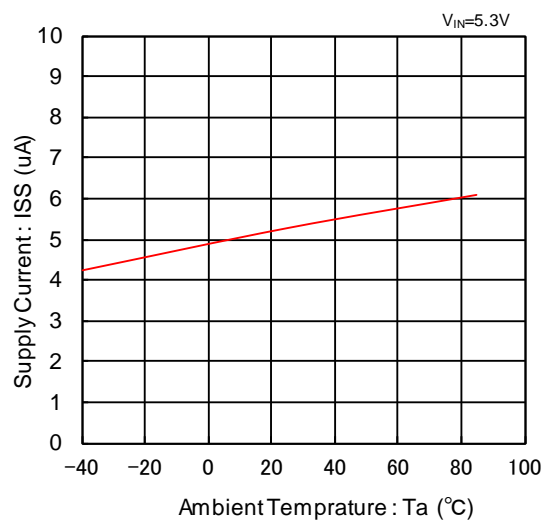

XC6216/XE6216 Series

TYPICAL PERFORMANCE CHARACTERISTICS (Continued)

(4) Supply Current vs. Input Voltage (Continued)

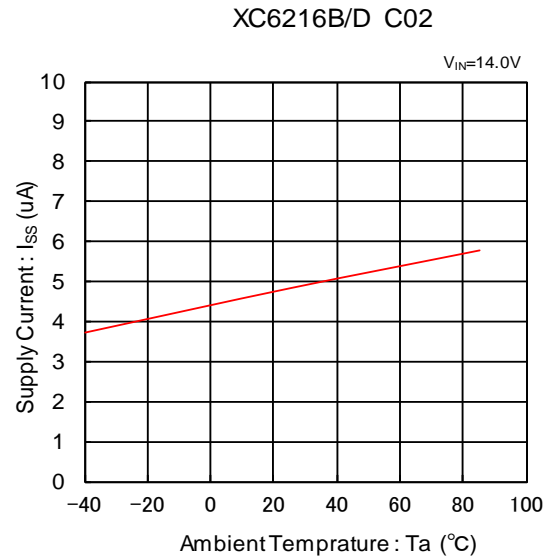
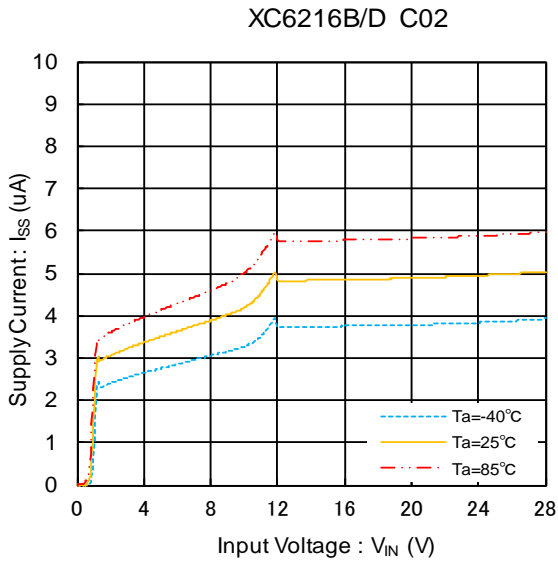
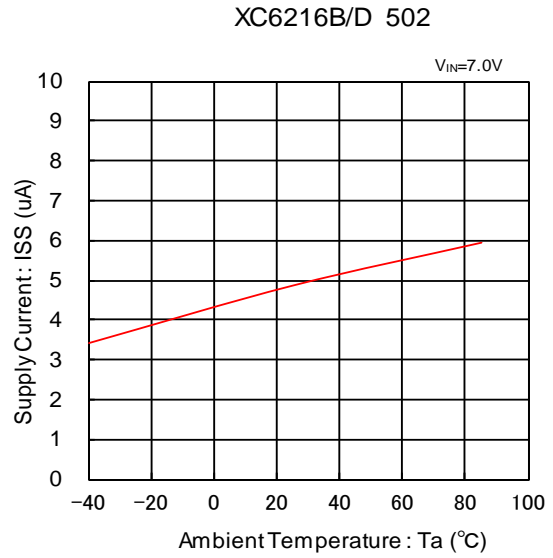
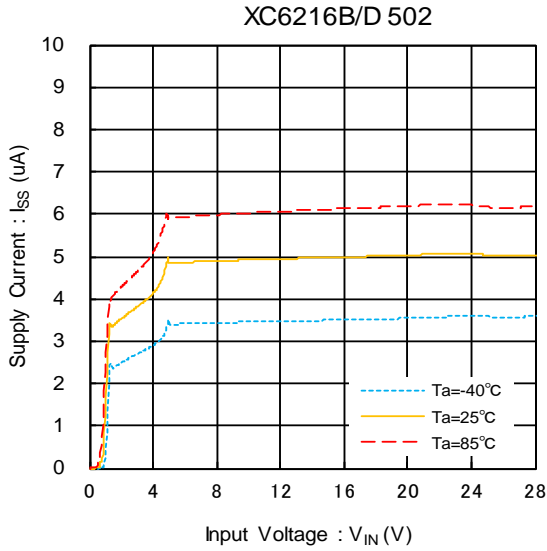

(5) Output Voltage vs. Ambient Temperature

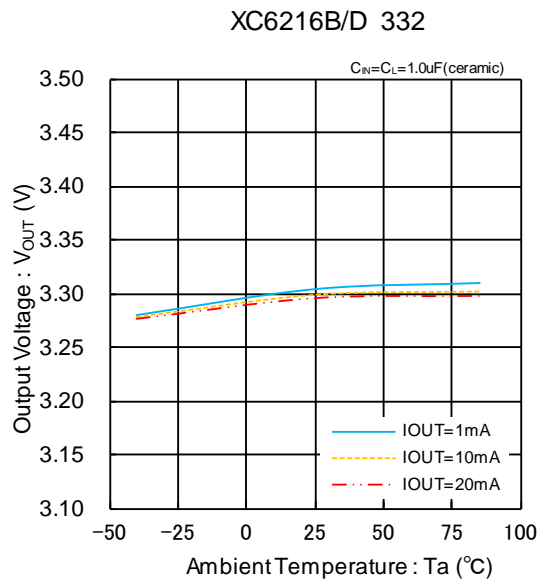
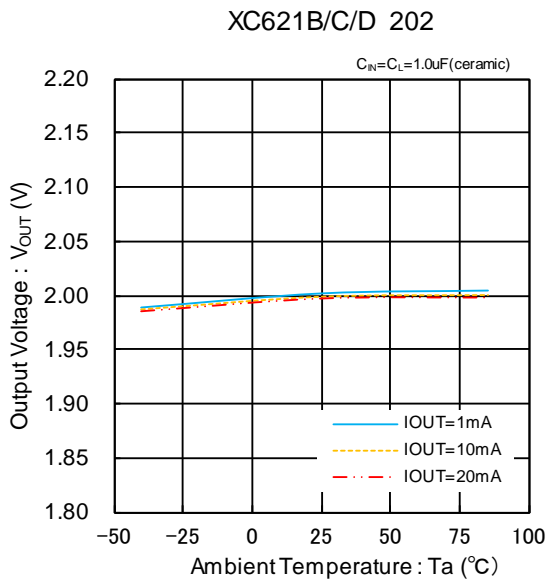

TYPICAL PERFORMANCE CHARACTERISTICS (Continued)

(5) Output Voltage vs. Ambient Temperature (Continued)

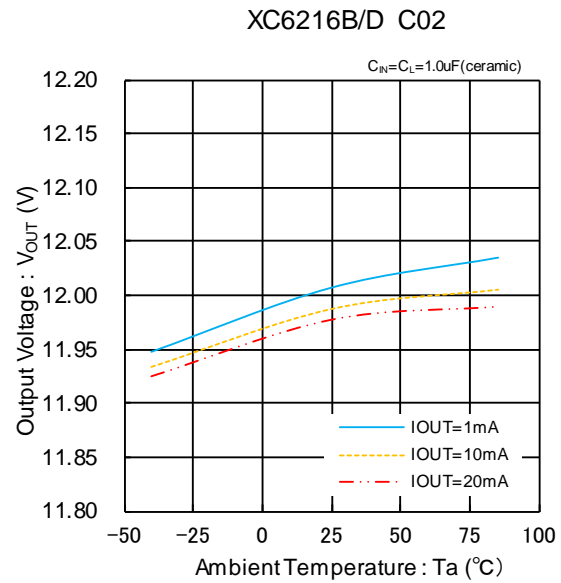
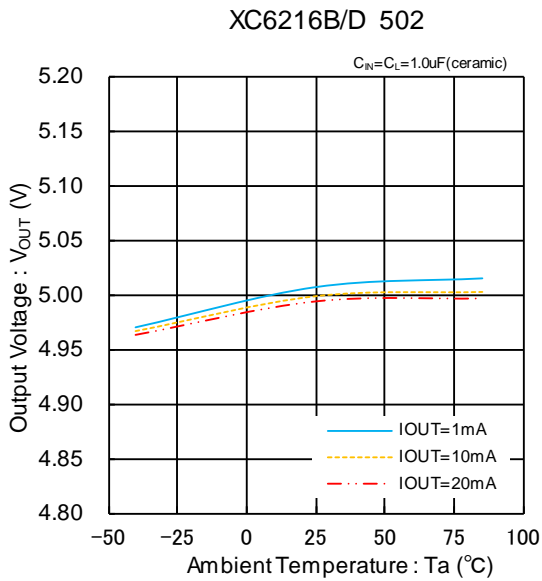

(6) Line Transient Response

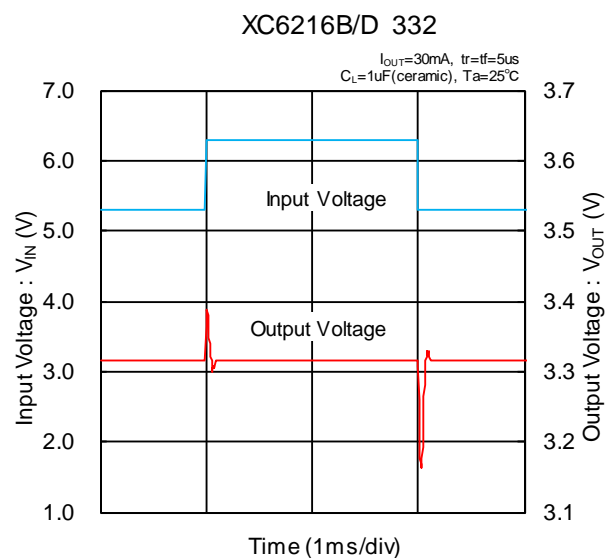
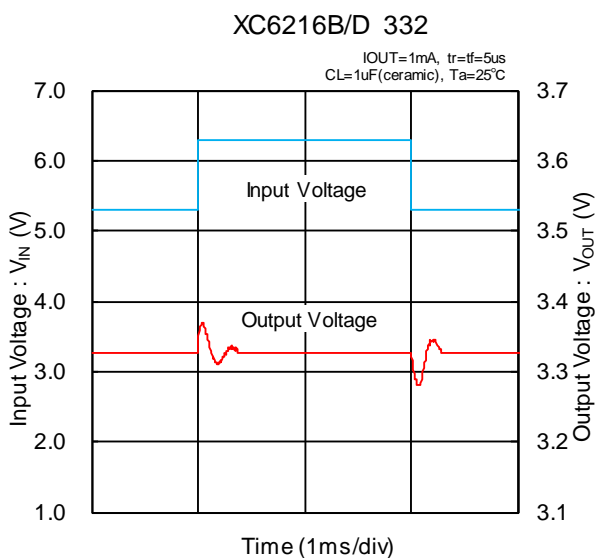
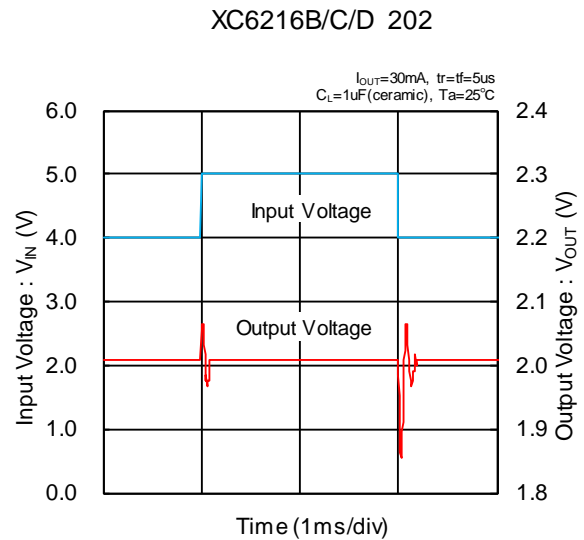
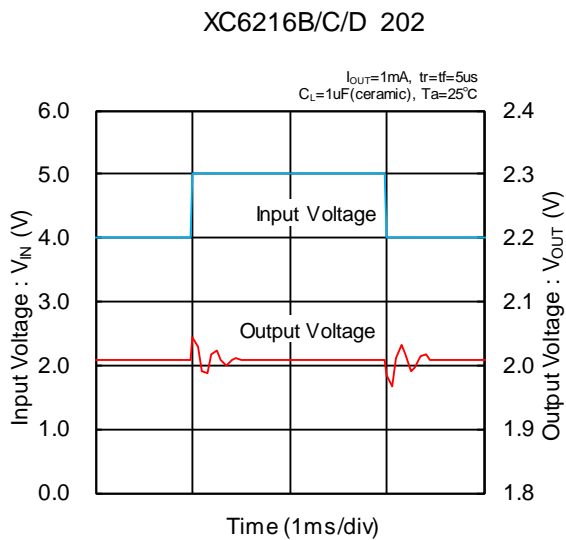

TYPICAL PERFORMANCE CHARACTERISTICS (Continued)

(6) Line Transient Response (Continued)

XC6216B/D 502

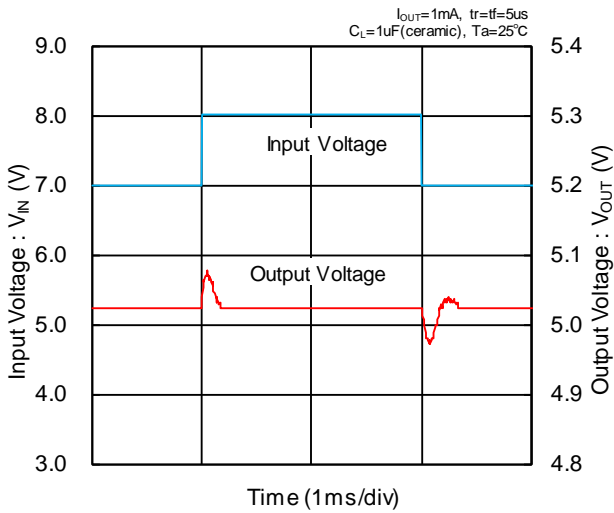

XC6216B/D 502

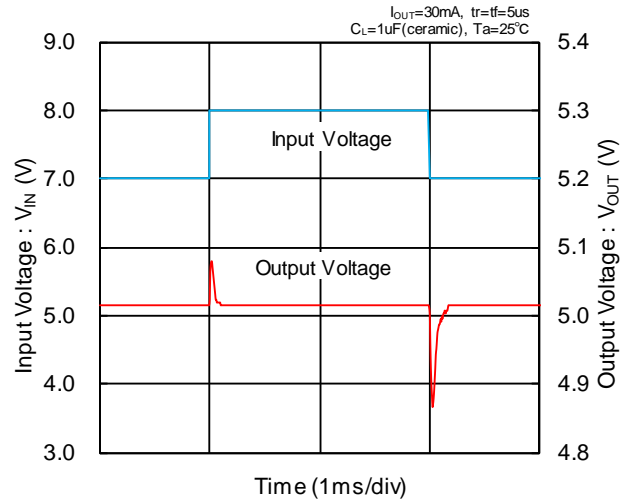

XC6216B/D C02

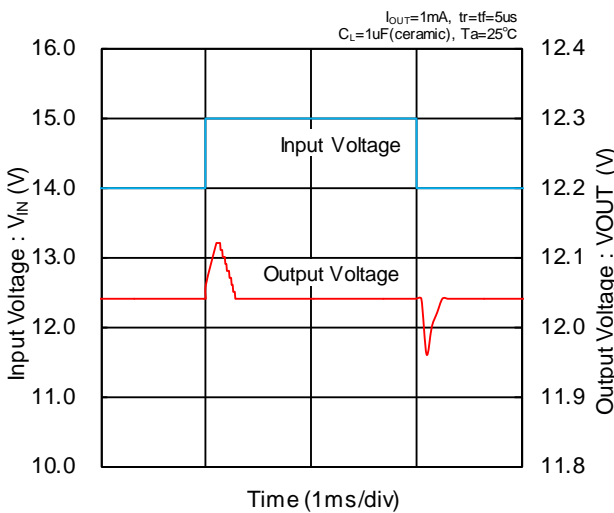

XC6216B/D C02

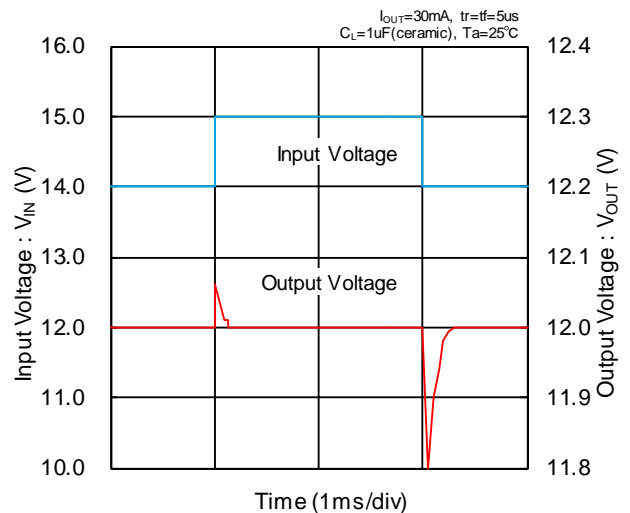

(7) Load Transient Response

XC6216B/C/D 202

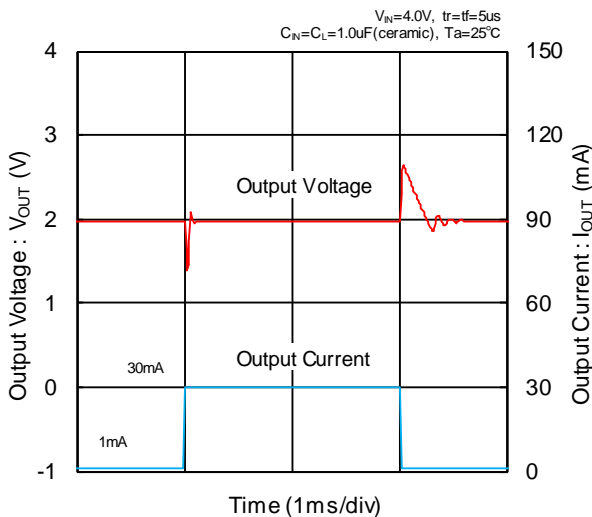

XC6216B/D 332

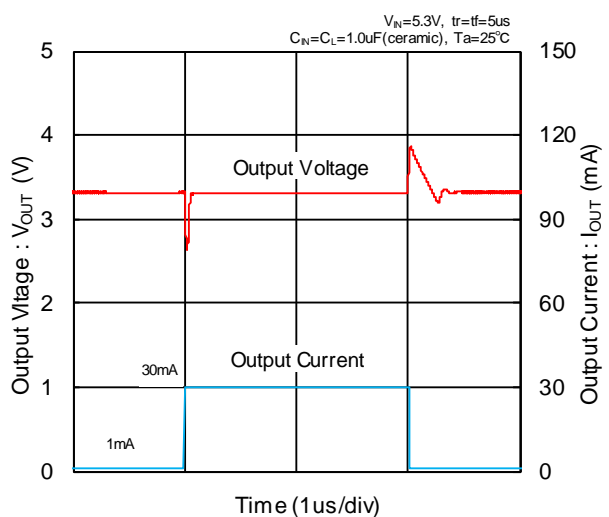

■ TYPICAL PERFORMANCE CHARACTERISTICS (Continued)

(7) Load Transient Response (Continued)

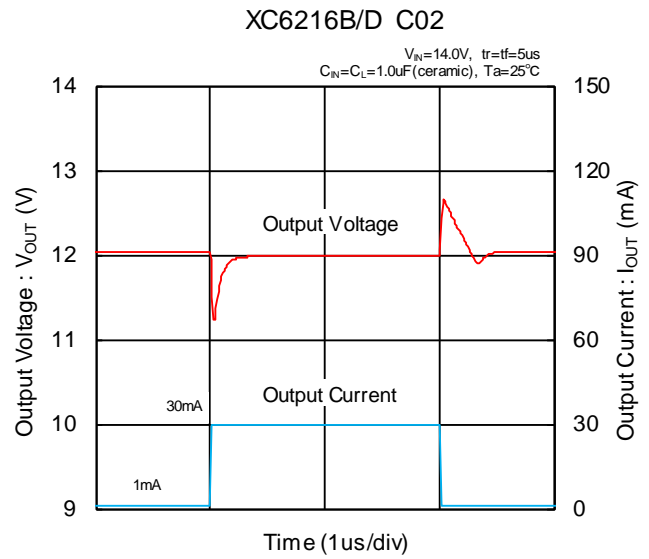
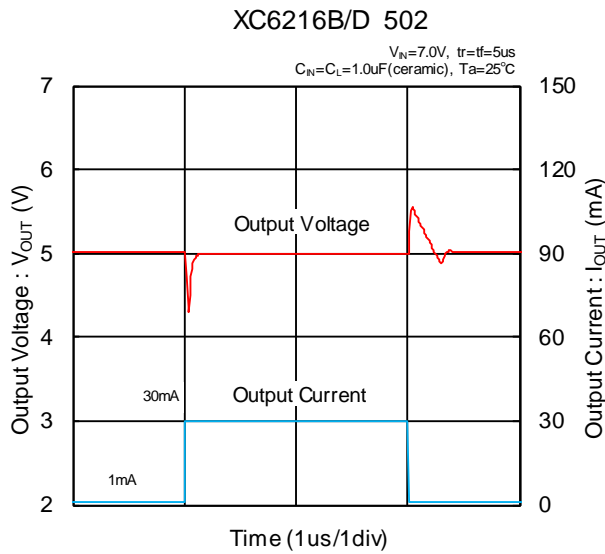

(8) Input Rise Time

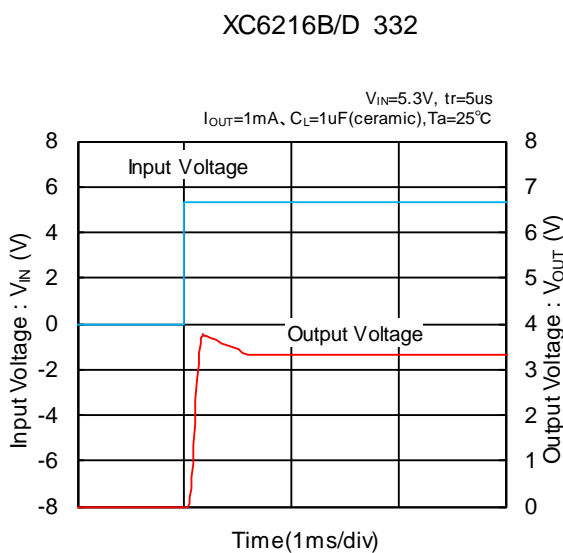
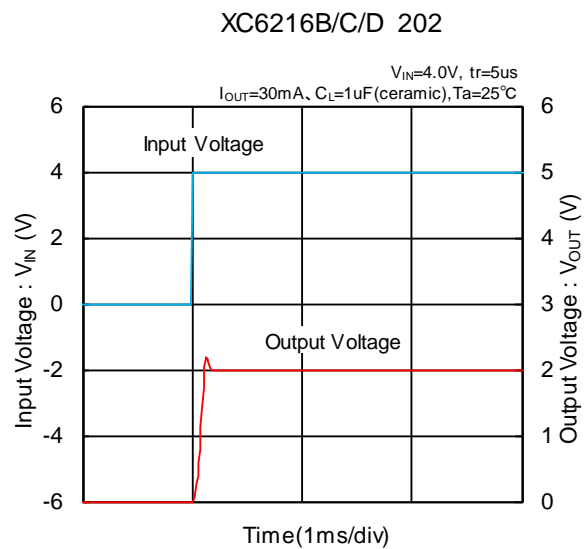
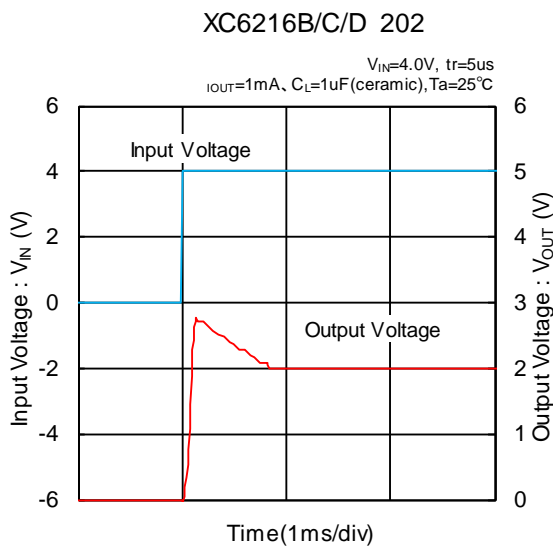

TYPICAL PERFORMANCE CHARACTERISTICS (Continued)

(8) Input Rise Time (Continued)

XC6216B/D 502



XC6216B/D 502

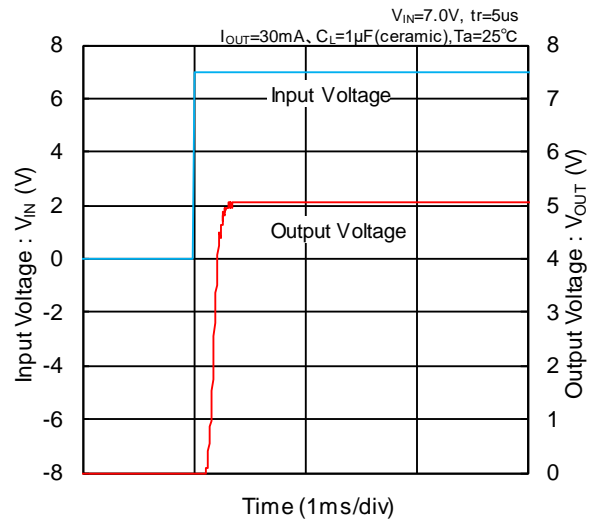

XC6216B/D C02



XC6216B/D C02

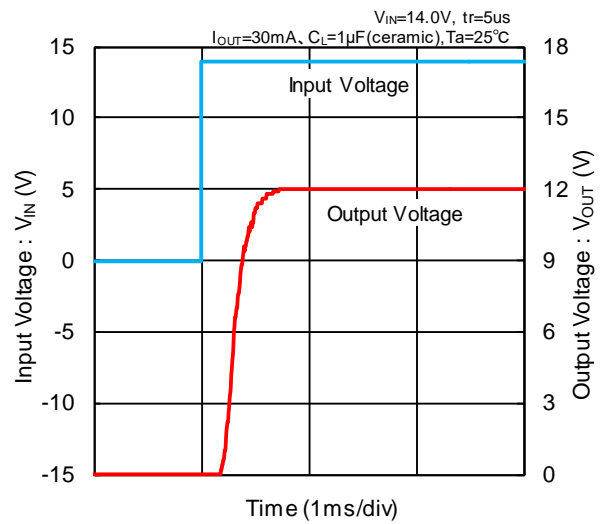

(9) CE Rise Time

XC6216B/C/D 202

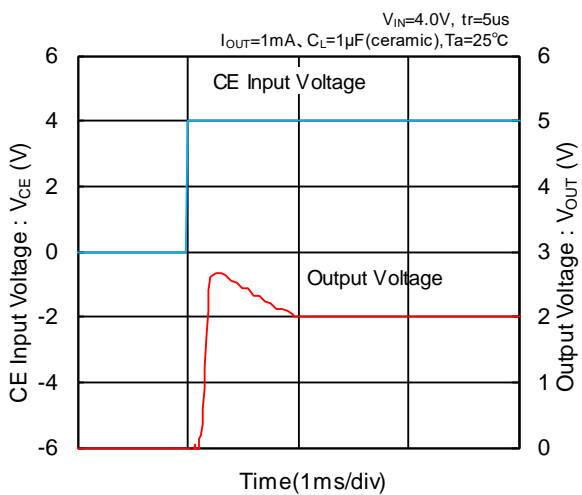

XC6216B/C/D 202

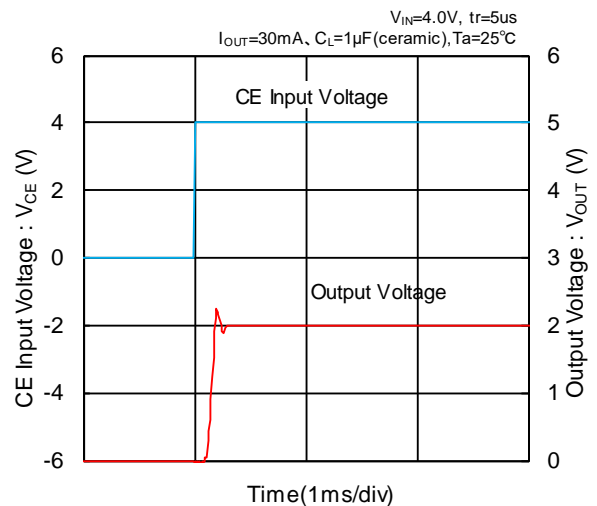

TYPICAL PERFORMANCE CHARACTERISTICS (Continued)

(9) CE Rise Time (Continued)

XC6216B/D 332



XC6216B/D 332



XC6216B/D 502

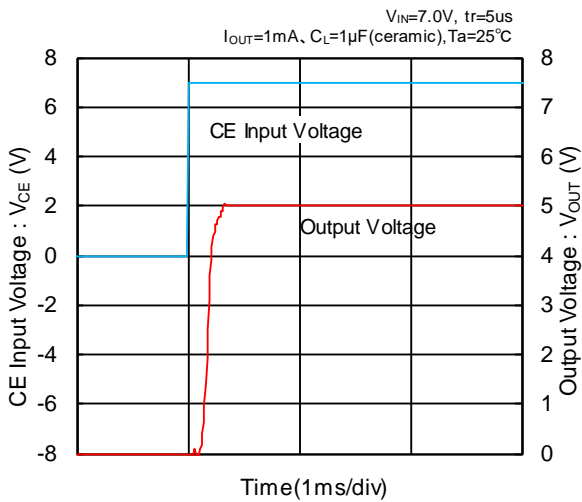

XC6216B/D 502

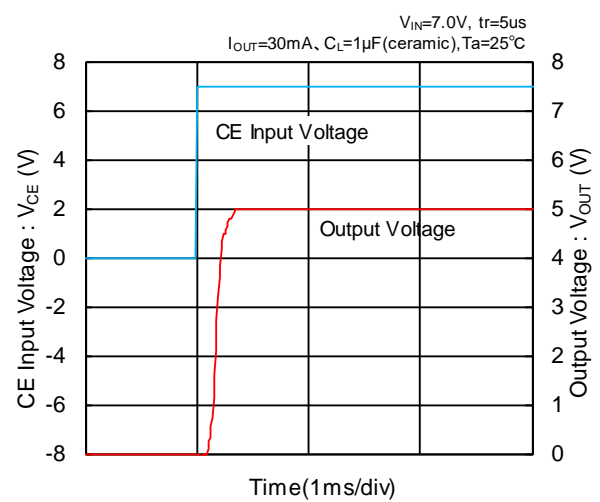

XC6216B/D C02



XC6216B/D C02

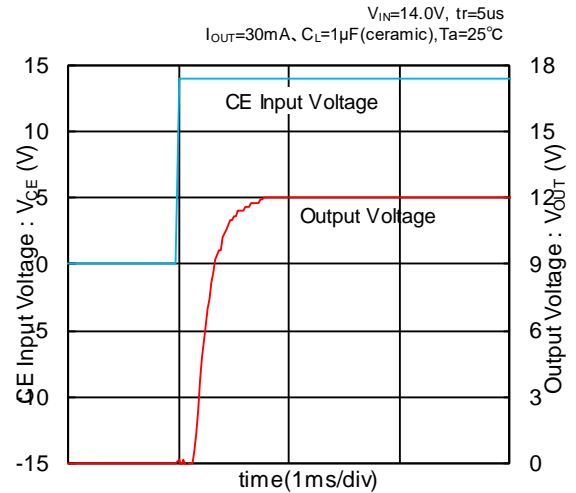

TYPICAL PERFORMANCE CHARACTERISTICS (Continued)

(10) Ripple Rejection Rate

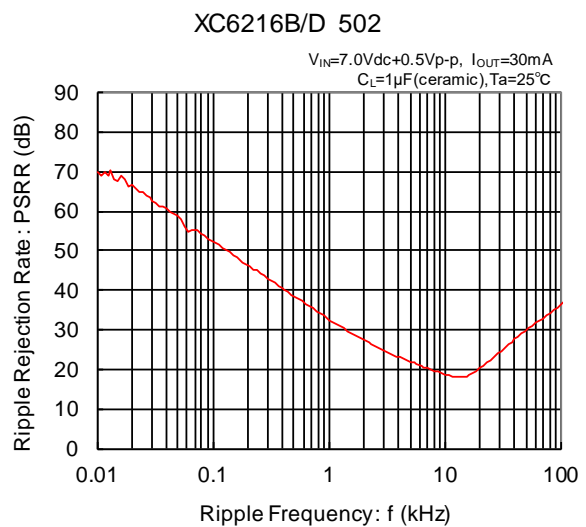
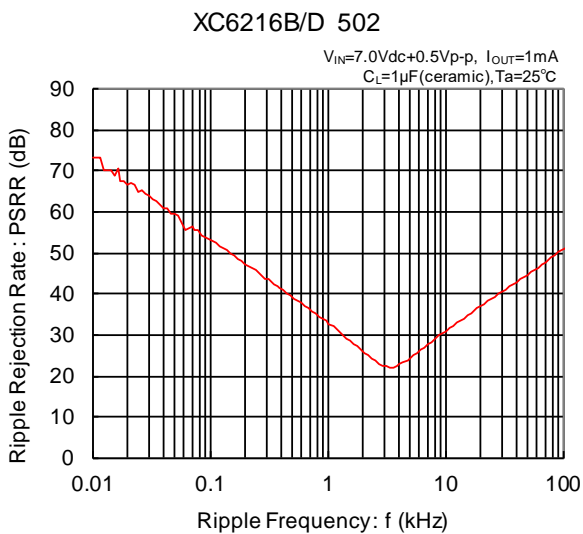
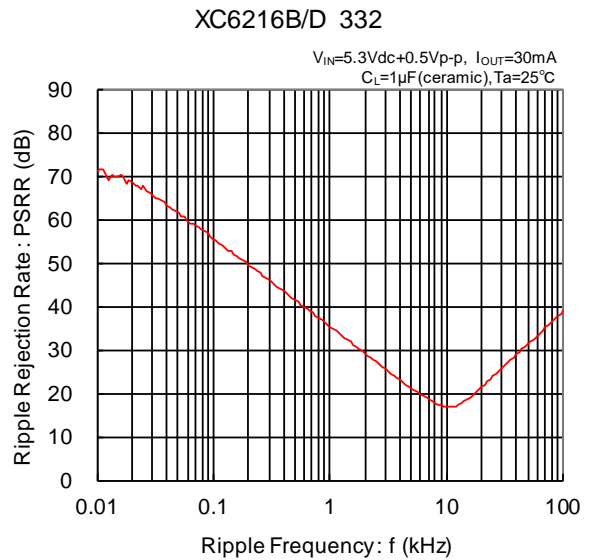
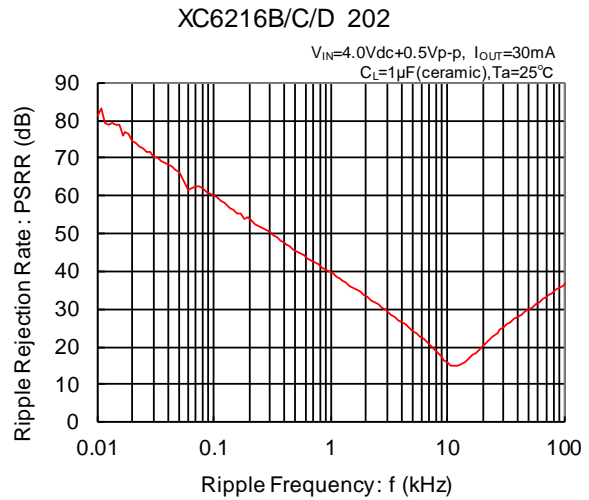
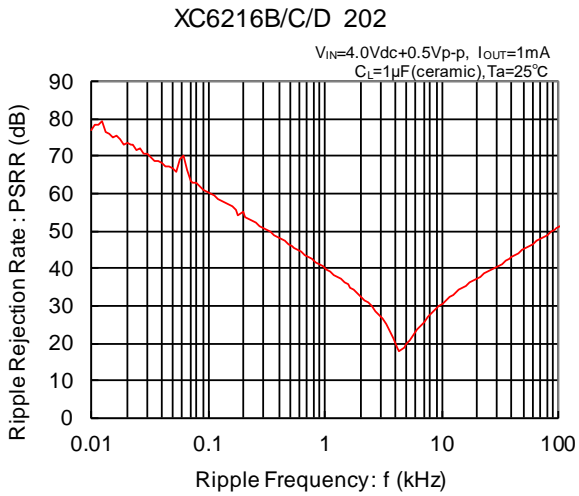

■ TYPICAL PERFORMANCE CHARACTERISTICS (Continued)

(10) Ripple Rejection Time (Continued)

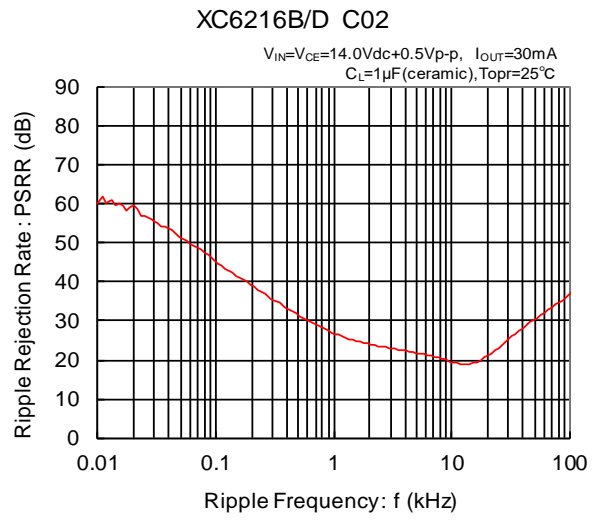
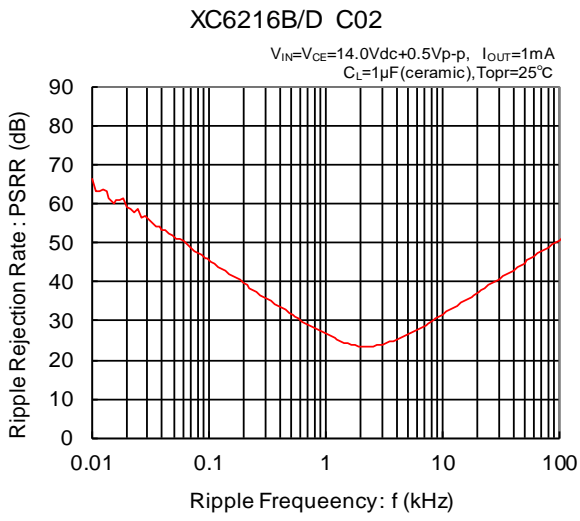

■ PACKAGING INFORMATION

For the latest package information go to, www.torexsemi.com/technical-support/packages

PACKAGE	OUTLINE / LAND PATTERN	THERMAL CHARACTERISTICS	
SOT-23	SOT-23 PKG	Standard Board	SOT-23 Power Dissipation
SOT-25	SOT-25 PKG	Standard Board	SOT-25 Power Dissipation
		JESD51-7 Board	
SOT-89	SOT-89 PKG	Standard Board	SOT-89 Power Dissipation
SOT-89-5	SOT-89-5 PKG	Standard Board	SOT-89-5 Power Dissipation
		JESD51-7 Board	
SOT-223	SOT-223 PKG	Standard Board	SOT-223 Power Dissipation
TO-252	TO-252 PKG	Standard Board	TO-252 Power Dissipation
USP-6C	USP-6C PKG	Standard Board	USP-6C Power Dissipation
		JESD51-7 Board	
USP-6B06	USP-6B06 PKG	Standard Board	USP-6B06 Power Dissipation

■ MARKING RULE (XC6216 Series)

● SOT-25, SOT-89, SOT-89-5, USP-6C, SOT-223, TO-252, USP-6B06, SOT-23

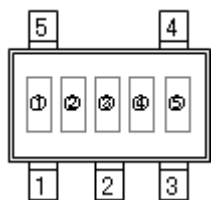

SOT-25

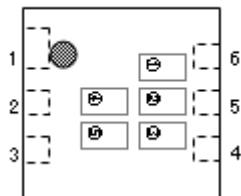

USP-6C

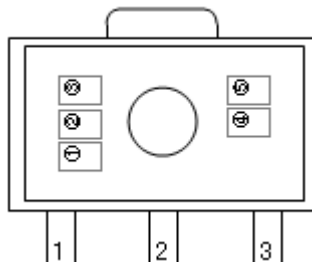

SOT-89

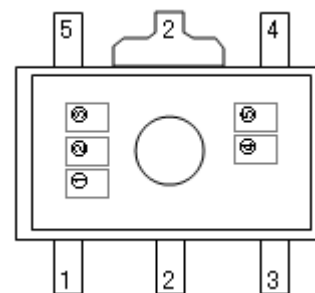

SOT-89-5

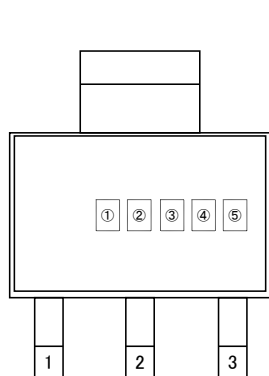

SOT-223

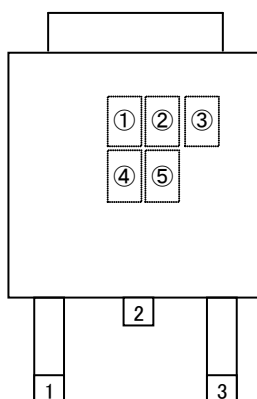

TO-252

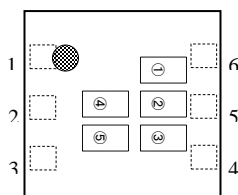

USP-6B06

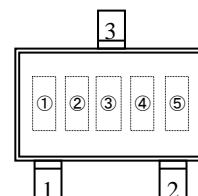

SOT-23

(mark header : ①~③) *Mark header does not change with a lot.

① represents the product series

MARK	PRODUCT SERIES
2	XC6216xxxxxx

② represents the output voltage range

MARK	VOLTAGE (V)	PRODUCT SERIES
0	1.8~3.0	XC6216Bxxxxx
1	3.1~6.0	
2	6.1~9.0	
3	9.1~12.0	
4	1.8~3.0	XC6216Dxxxxx
5	3.1~6.0	
6	6.1~9.0	
7	9.1~12.0	
8	2.0	XC6216Cxxxxx

■ MARKING RULE (XC6216 Series) (Continued)

③ represents the output voltage

MARK	VOLTAGE(V)			MARK	VOLTAGE(V)				
0	-	3.1	6.1	9.1	F	-	4.6	7.6	10.6
1	-	3.2	6.2	9.2	H	-	4.7	7.7	10.7
2	-	3.3	6.3	9.3	K	1.8	4.8	7.8	10.8
3	-	3.4	6.4	9.4	L	1.9	4.9	7.9	10.9
4	-	3.5	6.5	9.5	M	2.0	5.0	8.0	11.0
5	-	3.6	6.6	9.6	N	2.1	5.1	8.1	11.1
6	-	3.7	6.7	9.7	P	2.2	5.2	8.2	11.2
7	-	3.8	6.8	9.8	R	2.3	5.3	8.3	11.3
8	-	3.9	6.9	9.9	S	2.4	5.4	8.4	11.4
9	-	4.0	7.0	10.0	T	2.5	5.5	8.5	11.5
A	-	4.1	7.1	10.1	U	2.6	5.6	8.6	11.6
B	-	4.2	7.2	10.2	V	2.7	5.7	8.7	11.7
C	-	4.3	7.3	10.3	X	2.8	5.8	8.8	11.8
D	-	4.4	7.4	10.4	Y	2.9	5.9	8.9	11.9
E	-	4.5	7.5	10.5	Z	3.0	6.0	9.0	12.0

④⑤ represents assembly lot number

01 to 09, 0A to 0Z, 11 to 9Z, A1 to A9, AA to AZ, B1 to ZZ repeated (G, I, J, O, Q, W excluded)

Note: No character inversion used.

MARKING RULE (XE6216 Series)

● SOT-89-5

① represents the product series

MARK	PRODUCT SERIES
2	XE6216xxxxxx

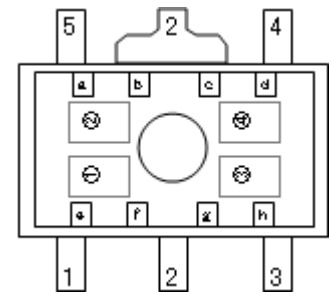

SOT-89-5

② represents the output voltage range

MARK	VOLTAGE (V)	PRODUCT SERIES
0	2.0~3.0	XE6216Bxxxxx
1	3.1~6.0	
2	6.1~9.0	
3	9.1~12.0	

MARK	VOLTAGE(V)			MARK	VOLTAGE(V)				
0	-	3.1	6.1	9.1	F	-	4.6	7.6	10.6
1	-	3.2	6.2	9.2	H	-	4.7	7.7	10.7
2	-	3.3	6.3	9.3	K	-	4.8	7.8	10.8
3	-	3.4	6.4	9.4	L	-	4.9	7.9	10.9
4	-	3.5	6.5	9.5	M	2.0	5.0	8.0	11.0
5	-	3.6	6.6	9.6	N	2.1	5.1	8.1	11.1
6	-	3.7	6.7	9.7	P	2.2	5.2	8.2	11.2
7	-	3.8	6.8	9.8	R	2.3	5.3	8.3	11.3
8	-	3.9	6.9	9.9	S	2.4	5.4	8.4	11.4
9	-	4.0	7.0	10.0	T	2.5	5.5	8.5	11.5
A	-	4.1	7.1	10.1	U	2.6	5.6	8.6	11.6
B	-	4.2	7.2	10.2	V	2.7	5.7	8.7	11.7
C	-	4.3	7.3	10.3	X	2.8	5.8	8.8	11.8
D	-	4.4	7.4	10.4	Y	2.9	5.9	8.9	11.9
E	-	4.5	7.5	10.5	Z	3.0	6.0	9.0	12.0

④ represents assembly lot number

0, ..., 9, A, B, ..., Z, □, ..., □, A, B, ..., □, 0, ..., repeated (G, I, J, O, Q, W excluded)

Bar marking of a-b-c-d combination represents production year.

Production Year	a	b	c	d
xxx0	□	-	-	-
xxx1	-	□	-	-
xxx2	-	-	□	-
xxx3	-	-	-	□
xxx4	□	□	-	-
xxx5	□	-	□	-
xxx6	□	-	-	□
xxx7	-	□	□	-
xxx8	-	□	-	□
xxx9	-	-	□	□

Bar marking of e-f-g-h combination represents production month.

Production Month	e	f	g	h
January	□	-	-	-
February	-	□	-	-
March	-	-	□	-
April	-	-	-	□
May	□	□	-	-
June	□	-	□	-
July	□	-	-	□
August	-	□	□	-
September	-	□	-	□
October	-	-	□	□
November	□	□	□	-
December	□	□	-	□