

## 1A LDO Voltage Regulator with "Green Operation"

## ■ GENERAL DESCRIPTION

☆ Green Operation-Compatible

The XC6220 series is a highly accurate, low noise, high speed, low dropout, and large current CMOS voltage regulator with Green Operation function. The series consists of a voltage reference, an error amplifier, a current limiter, an inrush current prevention circuit and a phase compensation circuit plus a driver transistor.

With a 0.2Ω on-resistance driver transistor integrated, the ultra low dropout voltage performance with output currents up to 1A greatly extends battery life as does the Green Operation function which can switch between high speed and power save modes automatically. A low ESR ceramic capacitor can be used for the output stabilization capacitor ( $C_L$ ).

Output voltage is selectable in 0.05V increments within the range of 0.8V~5.0V, using laser trimming technologies.

An over current protection circuit and a thermal shutdown circuit are built in. The over current protection circuit will operate when the output current reaches its limit current. The thermal shutdown circuit will operate when the junction temperature reaches its limit temperature. The inrush prevention circuit works by controlling the inrush current which charges to  $C_L$  when the IC starts up. In this way, voltage fluctuations in power supply caused by inrush current during system start up can be minimized.

The CE function enables the output to be turned off and the IC becomes a stand-by mode resulting in greatly reduced power consumption.

## ■ APPLICATIONS

- Optical disk drive
- Magnetic disk drive
- Digital still cameras / Camcorders
- Digital audio equipments

## ■ FEATURES

<b>Maximum Output Current</b>	: 1000mA ( $1.2V \leq V_{OUT} \leq 5.0V$ )
<b>Dropout Voltage</b>	: 20mV @ 100mA ( $V_{OUT}=3.0V$ ) : 60mV @ 300mA ( $V_{OUT}=3.0V$ )
<b>Operating Voltage Range</b>	: 1.6V ~ 6.0V
<b>Output Voltage Range</b>	: 0.8V ~ 5.0V (0.05V increments)
<b>Accuracy</b>	: $\pm 1\%$ ( $V_{OUT} \geq 2.0V$ ) : $\pm 20mV$ ( $V_{OUT} < 2.0V$ )
<b>Low Power Consumption</b>	: 8μA (TYP.) in PS mode : 50μA (TYP.) in HS mode
<b>Operating Ambient Temperature</b>	: -40°C ~ 85°C
<b>Thermal Shutdown</b>	: Detect 150°C, Release 135°C (TYP.)
<b>Inrush Current Prevention</b>	: 700mA (MAX.)
<b><math>C_L</math> Auto Discharge</b>	: XC6220 Series B/D type
<b>CE Pull-Down Resistor</b>	: XC6220 Series C/D type
<b>Output Capacitor</b>	: Ceramic Capacitor Compatible
<b>Packages</b>	: USP-6C, SOT-25, SOT-89-5 SOP-8FD
<b>Environmentally Friendly</b>	: EU RoHS Compliant, Pb Free

## ■ TYPICAL APPLICATION CIRCUIT



## ■ TYPICAL PERFORMANCE CHARACTERISTICS

XC6220x181



## BLOCK DIAGRAMS



●XC6220 Series Type A (Semi-custom)



●XC6220 Series Type B



●XC6220 Series Type C (Semi-custom)



●XC6220 Series Type D (Semi-custom)

\* Diodes inside the circuits are ESD protection diodes and parasitic diodes.

## PRODUCT CLASSIFICATION

### Ordering Information

XC6220 ①②③④⑤⑥-⑦<sup>(\*)</sup>

DESIGNATOR	ITEM	SYMBOL	DESCRIPTION
①	Type of CE	A	without CE Pull-down resistor, without C <sub>L</sub> discharge (Semi-custom)
		B	without CE Pull-down resistor, with C <sub>L</sub> discharge (Standard)
		C	with CE Pull-down resistor, without C <sub>L</sub> discharge (Semi-custom)
		D	with CE Pull-down resistor, with C <sub>L</sub> discharge (Semi-custom)
②③	Output Voltage	08 ~ 50	e.g. 3.0V → ②=3, ③=0
④	Output Voltage (the 2 <sup>nd</sup> decimal place)	1	Output voltage {0.00v} (the 2 <sup>nd</sup> decimal place is "0")
		B	Output voltage {0.05v} (the 2 <sup>nd</sup> decimal place is "5")
⑤⑥-⑦	Packages (Order Unit)	MR	SOT-25 (3,000pcs/Reel)
		MR-G	SOT-25 (3,000pcs/Reel)
		PR	SOT-89-5 (1,000pcs/Reel)
		PR-G	SOT-89-5 (1,000pcs/Reel)
		ER	USP-6C (3,000pcs/Reel)
		ER-G	USP-6C (3,000pcs/Reel)
		QR-G	SOP-8FD (1,000pcs/Reel)

<sup>(\*)</sup> The "-G" suffix denotes Halogen and Antimony free as well as being fully EU RoHS compliant.

### Selection Guide

TYPE	CE PULL-DOWN RESISTOR	CL AUTO-DISCHARGE
A	No	No
B	No	Yes
C	Yes	No
D	Yes	Yes

## PIN CONFIGURATION

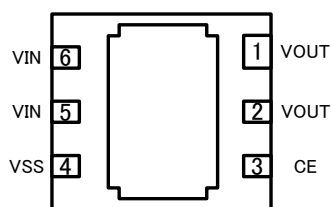

USP-6C  
(BOTTOM VIEW)



SOT-25  
(TOP VIEW)

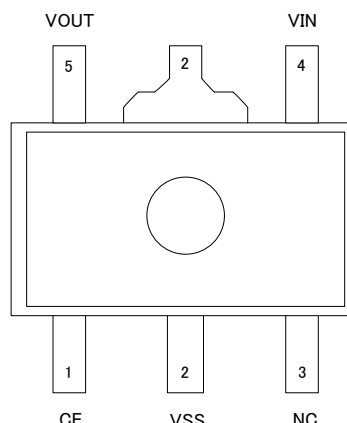

SOT-89-5  
(TOP VIEW)

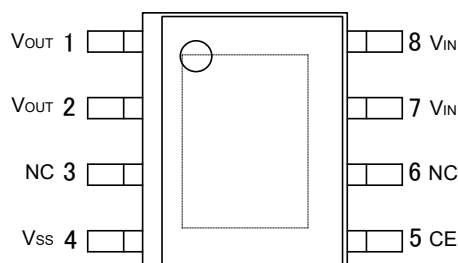

SOP-8FD  
(TOP VIEW)

\* For the USP-6C, the No.5 and 6  $V_{IN}$  pins should be connected. The No.1 and 2 pins  $V_{OUT}$  pins should be connected. The dissipation pad should be solder-plated in reference mount pattern and metal masking so as to enhance mounting strength and heat release. If the pad needs to be connected to other pins, it should be connected to the  $V_{SS}$  (No. 4) pin.

\* For the SOP-8FD, two power input pins (No.7 and No.8) output pins (No.1 and 2) should be connected. The dissipation pad should be solder-plated in electrically open or connecting to the  $V_{SS}$  (No.4) pin.

## PIN ASSIGNMENT

PIN NUMBER				PIN NAME	FUNCTIONS
SOT-25	SOT-89-5	USP-6C	SOP-8FD		
3	1	3	5	CE	ON/OFF Control
1	4	6 & 5	7,8	$V_{IN}$	Power Input
2	2	4	4	$V_{SS}$	Ground
5	5	1 & 2	1,2	$V_{OUT}$	Output
4	3	-	3,6	NC	No connection

## FUNCTIONS

PIN NAME	DESIGNATOR	CONDITIONS	IC OPERATION
CE	L	$V_{CE} \leq 0.4V$	OFF
	H	$1.2V \leq V_{CE} \leq 6.0V$	ON
	OPEN	$V_{CE} = \text{OPEN}^{(*)}$	Undefined state (XC6220A/B Series) OFF (XC6220C/D Series)

(\*) Please avoid the state of OPEN, and connect CE pin to any arbitrary voltage.

\* For the XC6220C/D series, CE function logic is fixed as L level because of the CE pull-down resistor.

## ■ ABSOLUTE MAXIMUM RATINGS

PARAMETER		SYMBOL	RATINGS	UNITS
Input Voltage		$V_{IN}$	$V_{SS} - 0.3 \sim 6.5$	V
Output Voltage		$V_{OUT}$	$V_{SS} - 0.3 \sim V_{IN} + 0.3$	V
CE Input Voltage		$V_{CE}$	$V_{SS} - 0.3 \sim 6.5$	V
Power Dissipation ( $T_a=25^\circ\text{C}$ )	SOT-25	Pd	250	mW
			600 (40mm x 40mm Standard Board) <sup>(*)1</sup>	
			760 (JESD51-7 Board) <sup>(*)1</sup>	
	SOT-89-5		500	
			1300 (40mm x 40mm Standard Board) <sup>(*)1</sup>	
			1750 (JESD51-7 Board) <sup>(*)1</sup>	
	USP-6C		120	
			1000 (40mm x 40mm Standard Board) <sup>(*)1</sup>	
	SOP-8FD		1250 (JESD51-7 Board) <sup>(*)1</sup>	
			300	
1500 (40mm x 40mm Standard Board) <sup>(*)1</sup>				
Operating Ambient Temperature		$T_{opr}$	-40 ~ 85	°C
Storage Temperature		$T_{stg}$	-55 ~ 125	°C

<sup>(\*)1</sup> The power dissipation figure shown is PCB mounted and is for reference only.  
The mounting condition is please refer to PACKAGING INFORMATION.

## ■ ELECTRICAL CHARACTERISTICS

● XC6220A/B/C/D Series

Ta=25°C

PARAMETER	SYMBOL	CONDITIONS	MIN.	TYP.	MAX.	UNITS	CIRCUIT
Output Voltage	V <sub>OUT(E)</sub> (*1)	High Speed Mode (HS) 2.0V ≤ V <sub>OUT(T)</sub> ≤ 5.0V V <sub>CE</sub> =V <sub>IN</sub> , I <sub>OUT</sub> =30mA	×0.99	V <sub>OUT(T)</sub> (*2)	×1.01	V	①
		High Speed Mode (HS) 0.8V ≤ V <sub>OUT(T)</sub> ≤ 1.95V V <sub>CE</sub> =V <sub>IN</sub> , I <sub>OUT</sub> =30mA	-0.02		+0.02		
		Power Save Mode (PS) 2.0V ≤ V <sub>OUT(T)</sub> ≤ 5.0V V <sub>CE</sub> =V <sub>IN</sub> , I <sub>OUT</sub> =0.1mA	×0.98		×1.02		
		Power Save Mode (PS) 0.8V ≤ V <sub>OUT(T)</sub> ≤ 1.95V V <sub>CE</sub> =V <sub>IN</sub> , I <sub>OUT</sub> =0.1mA	-0.04		+0.04		
Output Current	I <sub>OUTMAX</sub>	V <sub>CE</sub> =V <sub>IN</sub> V <sub>IN</sub> =V <sub>OUT(T)</sub> +1.0V 0.8V ≤ V <sub>OUT(T)</sub> ≤ 1.15V	700	1200	-	mA	①
		V <sub>CE</sub> =V <sub>IN</sub> V <sub>IN</sub> =V <sub>OUT(T)</sub> +1.0V 1.2V ≤ V <sub>OUT(T)</sub> ≤ 5.0V	1000	1200	-		
Load Regulation	ΔV <sub>OUT</sub>	High Speed Mode (HS), V <sub>CE</sub> =V <sub>IN</sub> , 10mA ≤ I <sub>OUT</sub> ≤ 300mA	-	10	45	mV	①
Dropout Voltage1	V <sub>dif</sub> (*3)	I <sub>OUT</sub> =300mA, V <sub>CE</sub> =V <sub>IN</sub>	-	E-1		mV	①
Dropout Voltage2	V <sub>dif</sub> (*3)	I <sub>OUT</sub> =1000mA, V <sub>CE</sub> =V <sub>IN</sub>	-	-	E-2	mV	①
Supply Current 1	I <sub>SS1</sub>	High Speed Mode(HS) V <sub>IN</sub> =V <sub>CE</sub> =V <sub>OUT(T)</sub> +1.0V I <sub>OUT</sub> =10mA (A/B Series)	-	50	108	μA	②
		High Speed Mode(HS) V <sub>IN</sub> =V <sub>CE</sub> =V <sub>OUT(T)</sub> +1.0V I <sub>OUT</sub> =10mA (C/D Series)	-	50	E-3		
Supply Current 2	I <sub>SS2</sub>	Power Save Mode(PS) V <sub>IN</sub> =V <sub>CE</sub> =V <sub>OUT(T)</sub> +1.0V I <sub>OUT</sub> =0.1mA (A/B Series)	-	8	18	μA	②
		Power Save Mode(PS) V <sub>IN</sub> =V <sub>CE</sub> =V <sub>OUT(T)</sub> +1.0V I <sub>OUT</sub> =0.1mA (C/D Series)	-	8	E-4		
Stand-by Current	I <sub>STBY</sub>	V <sub>IN</sub> =6.0V, V <sub>CE</sub> =V <sub>SS</sub>	-0.1	0.01	0.1	μA	②
Line Regulation	ΔV <sub>OUT</sub> / (ΔV <sub>IN</sub> ·V <sub>OUT</sub> )	V <sub>OUT(T)</sub> +0.5V ≤ V <sub>IN</sub> ≤ 6.0V 1.1V ≤ V <sub>OUT(T)</sub> ≤ 5.0V V <sub>CE</sub> =V <sub>IN</sub> , I <sub>OUT</sub> =100mA	-	0.01	0.20	%V	①
		1.6V ≤ V <sub>IN</sub> ≤ 6.0V 0.8V ≤ V <sub>OUT(T)</sub> ≤ 1.05V V <sub>CE</sub> =V <sub>INm</sub> , I <sub>OUT</sub> =100mA					
Input Voltage	V <sub>IN</sub>		1.6	-	6.0	V	①
Output Voltage Temperature Characteristics	ΔV <sub>OUT</sub> / (ΔTa·V <sub>OUT</sub> )	V <sub>CE</sub> =V <sub>IN</sub> I <sub>OUT</sub> =30mA -40°C ≤ Ta ≤ 85°C	-	±100	-	ppm/°C	①

## ELECTRICAL CHARACTERISTICS (Continued)

Ta=25°C

PARAMETER	SYMBOL	CONDITIONS	MIN.	TYP.	MAX.	UNITS	CIRCUIT
Ripple Rejection Ratio	PSRR	$V_{IN}=5.75VDC+0.5Vp-pAC$ $4.75V \leq V_{OUT(T)} \leq 5.0V$ $V_{CE}=V_{IN}, I_{OUT}=30mA, f=1kHz$	-	50	-	dB	③
		$V_{IN}=\{V_{OUT(T)}+1.0\}VDC+0.5Vp-pAC$ $0.85V \leq V_{OUT(T)} \leq 4.7V$ $V_{CE}=V_{IN}, I_{OUT}=30mA, f=1kHz$					
		$V_{IN}=1.85VDC+0.5Vp-pAC$ $V_{OUT(T)}=0.8V$ $V_{CE}=V_{IN}, I_{OUT}=30mA, f=1kHz$					
Limit Current	I <sub>LIM</sub>	$V_{CE}=V_{IN}=V_{OUT(T)}+1.0V$ $0.8V \leq V_{OUT(T)} \leq 1.15V$	705	1200	-	mA	①
		$V_{CE}=V_{IN}=V_{OUT(T)}+1.0V$ $1.2V \leq V_{OUT(T)} \leq 5.0V$	1005	1200	-		
Short Current	I <sub>SHORT</sub>	$V_{CE}=V_{IN}$ Short V <sub>OUT</sub> to V <sub>SS</sub> level	-	180	-	mA	①
PS Switching Current	I <sub>GOR</sub>	: $1.45V \leq V_{OUT(T)} \leq 5.0V$ $V_{IN}=V_{OUT(T)}+1.0V, V_{CE}=V_{IN}$ : $0.8V \leq V_{OUT(T)} \leq 1.4V$ $V_{IN}=1.6V, V_{CE}=V_{IN}$ I <sub>OUT</sub> =heavy to light load	1.0	2.0	-	mA	⑤
HS Switching Current	I <sub>GO</sub>	: $1.45V \leq V_{OUT(T)} \leq 5.0V$ $V_{IN}=V_{OUT(T)}+1.0V, V_{CE}=V_{IN}$ : $0.8V \leq V_{OUT(T)} \leq 1.4V$ $V_{IN}=1.6V, V_{CE}=V_{IN}$ I <sub>OUT</sub> =light to heavy load	-	5.0	10	mA	⑤
Switch Current Hysteresis Range	I <sub>GOhys</sub>	I <sub>GOhys</sub> =I <sub>GO</sub> -I <sub>GOR</sub>	-	3.0	-	mA	⑤
PS Switching Delay Time	t <sub>DPS</sub>	$V_{IN}=V_{OUT(T)}+1.0V, V_{CE}=V_{IN}$ Time until HS mode is changed-over to PS mode by I <sub>GOR</sub> .	-	-	E-5	μs	⑤
CE High Level Voltage	V <sub>CEH</sub>		1.2	-	6.0	V	④
CE Low Level Voltage	V <sub>CEL</sub>		V <sub>SS</sub>	-	0.4	V	④
CE High Level Current	I <sub>CEH</sub>	$V_{CE}=V_{IN}=6.0V$ (A/B series)	-0.1	-	0.1	μA	④
		$V_{CE}=V_{IN}=6.0V$ (C/D series)	-	9	15	μA	
CE Low Level Current	I <sub>CEL</sub>	$V_{CE}=V_{SS}$	-0.1	-	0.1	μA	④
CL Discharge Resistance <sup>(4)</sup>	R <sub>DCHG</sub>	$V_{IN}=6.0V, V_{OUT}=5.0V, V_{CE}=V_{SS}$	-	460	-	Ω	①
Thermal Shutdown Detect Temperature	T <sub>TSD</sub>	Junction Temperature	-	150	-	°C	①
Thermal Shutdown Release Temperature	T <sub>TSR</sub>	Junction Temperature	-	135	-	°C	①
Inrush Current	I <sub>RUSH</sub>	$V_{IN}=V_{OUT(T)}+1.0V, C_L=22\mu F$ $V_{CE}=0V \rightarrow V_{OUT(T)}+1.0V$ (Only when rising and within 1ms)	-	-	700	mA	⑥

\* 1: V<sub>OUT(E)</sub> = Effective output voltage

(The output voltage when an amply stabilized "V<sub>OUT(T)</sub> + 1.0V" is provided at the V<sub>IN</sub> pin while maintaining a certain I<sub>OUT</sub> value.)

\* 2: V<sub>OUT(T)</sub> = Nominal output voltage. (Shown in the voltage chart E-0)

\* 3: V<sub>dif</sub> = {V<sub>IN1</sub>-V<sub>OUT1</sub>}

V<sub>IN1</sub> is the input voltage when V<sub>OUT1</sub> appears at the V<sub>OUT</sub> pin while input voltage is gradually decreased.

V<sub>OUT1</sub> is the voltage equal to 98% of the HS mode output voltage when an amply stabilized V<sub>OUT(T)</sub> + 1.0V are supplied to the V<sub>IN</sub> pin.

\* 4: For the XC6220B/D series only. The XC6220A/C series (semi-custom) discharges by only R1 and R2 resistors as shown in the block diagrams.

**■ ELECTRICAL CHARACTERISTICS (Continued)**

● Voltage Chart 1

SYMBOL	E-0				E-1		E-2	E-3	E-4	E-5	
	NOMINAL OUTPUT VOLTAGE VOLTAGE (V)	OUTPUT VOLTAGE 1 (HS Mode) (V)		OUTPUT VOLTAGE 2 (PS Mode) (V)		DROPOUT VOLTAGE 1 Vdif 1 (mV) I <sub>OUT</sub> =300mA		DROPOUT VOLTAGE 2 Vdif 2 (mV) I <sub>OUT</sub> =1000mA	SUPPLY CURRENT 1 (XC6220C/D) ( $\mu$ A)	SUPPLY CURRENT 2 (XC6220C/D) ( $\mu$ A)	PS SWITCH DELAY TIME ( $\mu$ S)
		V <sub>OUT(T)</sub>	V <sub>OUT</sub>		V <sub>OUT</sub>		V <sub>dif1</sub>		V <sub>dif2</sub>	I <sub>SS1</sub>	I <sub>SS2</sub>
	MIN.	MAX.	MIN.	MAX.	TYP.	MAX.	MAX.	MAX.	MAX.	MAX.	MAX.
0.80	0.7800	0.8200	0.7600	0.8400	400	575	-	112.500	22.500	650	
0.85	0.8300	0.8700	0.8100	0.8900				112.625	22.625		
0.90	0.8800	0.9200	0.8600	0.9400				112.750	22.750		
0.95	0.9300	0.9700	0.9100	0.9900				112.875	22.875		
1.00	0.9800	1.0200	0.9600	1.0400	240	405		113.000	23.000		
1.05	1.0300	1.0700	1.0100	1.0900				113.125	23.125		
1.10	1.0800	1.1200	1.0600	1.1400				113.250	23.250		
1.15	1.1300	1.1700	1.1100	1.1900	180	305		113.375	23.375		
1.20	1.1800	1.2200	1.1600	1.2400	150	215		700	113.500		23.500
1.25	1.2300	1.2700	1.2100	1.2900					113.625		23.625
1.30	1.2800	1.3200	1.2600	1.3400			113.750		23.750		
1.35	1.3300	1.3700	1.3100	1.3900			113.875		23.875		
1.40	1.3800	1.4200	1.3600	1.4400			114.000		24.000		
1.45	1.4300	1.4700	1.4200	1.4800			114.125		24.125		
1.50	1.4800	1.5200	1.4700	1.5300	100	150	114.250	24.250			
1.55	1.5300	1.5700	1.5100	1.5900			114.375	24.375			
1.60	1.5800	1.6200	1.5600	1.6400			114.500	24.500			
1.65	1.6300	1.6700	1.6100	1.6900			114.625	24.625			
1.70	1.6800	1.7200	1.6600	1.7400			114.750	24.750			
1.75	1.7300	1.7700	1.7100	1.7900			114.875	24.875			
1.80	1.7800	1.8200	1.7600	1.8400			115.000	25.000			
1.85	1.8300	1.8700	1.8100	1.8900			115.125	25.125			
1.90	1.8800	1.9200	1.8600	1.9400			115.250	25.250			
1.95	1.9300	1.9700	1.9100	1.9900			115.375	25.375			
2.00	1.9800	2.0200	1.9600	2.0400	85	130	655	115.500	25.500		
2.05	2.0295	2.0705	2.0090	2.0910				115.625	25.625		
2.10	2.0790	2.1210	2.0580	2.1420				115.750	25.750		
2.15	2.1285	2.1715	2.1070	2.1930				115.875	25.875		
2.20	2.1780	2.2220	2.1560	2.2440				116.000	26.000		
2.25	2.2275	2.2725	2.2050	2.2950				116.125	26.125		
2.30	2.2770	2.3230	2.2540	2.3460				116.250	26.250		
2.35	2.3265	2.3735	2.3030	2.3970				116.375	26.375		
2.40	2.3760	2.4240	2.3520	2.4480				116.500	26.500		
2.45	2.4255	2.4745	2.4010	2.4990				116.625	26.625		
2.50	2.4750	2.5250	2.4500	2.5500	116.750	26.750					
2.55	2.5245	2.5755	2.4990	2.6010	116.875	26.875					
2.60	2.5740	2.6260	2.5480	2.6520	117.000	27.000					
2.65	2.6235	2.6765	2.5970	2.7030	117.125	27.125					
2.70	2.6730	2.7270	2.6460	2.7540	117.250	27.250					
2.75	2.7225	2.7775	2.6950	2.8050	117.375	27.375					
2.80	2.7720	2.8280	2.7440	2.8560	117.500	27.500					
2.85	2.8215	2.8785	2.7930	2.9070	117.625	27.625					
2.90	2.8710	2.9290	2.8420	2.9580	117.750	27.750					
2.95	2.9205	2.9795	2.8910	3.0090	117.875	27.875					
					65	110				1200	

## ELECTRICAL CHARACTERISTICS (Continued)

### Voltage Chart 2

SYMBOL	E-0				E-1		E-2	E-3	E-4	E-5	
	NOMINAL OUTPUT VOLTAGE (V)	OUTPUT VOLTAGE (HS Mode) (V)		OUTPUT VOLTAGE (PS Mode) (V)		DROPOUT VOLTAGE 1 V <sub>dif1</sub> (mV) I <sub>OUT</sub> =300mA		DROPOUT VOLTAGE 2 V <sub>dif2</sub> (mV) I <sub>OUT</sub> =1000mA	SUPPLY CURRENT 1 (XC6220C/D) ( $\mu$ A)	SUPPLY CURRENT 2 (XC6220C/D) ( $\mu$ A)	PS SWITCH DELAY TIME ( $\mu$ S)
		V <sub>OUT(T)</sub>	V <sub>OUT</sub>		V <sub>OUT</sub>		V <sub>dif1</sub>		V <sub>dif2</sub>	I <sub>SS1</sub>	I <sub>SS2</sub>
	MIN.	MAX.	MIN.	MAX.	TYP.	MAX.	MAX.	MAX.	MAX.	MAX.	MAX.
3.00	2.9700	3.0300	2.9400	3.0600	60	95	655	118.000	28.000	1200	
3.05	3.0195	3.0805	2.9890	3.1110				118.125	28.125		
3.10	3.0690	3.1310	3.0380	3.1620				118.250	28.250		
3.15	3.1185	3.1815	3.0870	3.2130				118.375	28.375		
3.20	3.1680	3.2320	3.1360	3.2640				118.500	28.500		
3.25	3.2175	3.2825	3.1850	3.3150				118.625	28.625		
3.30	3.2670	3.3330	3.2340	3.3660				118.750	28.750		
3.35	3.3165	3.3835	3.2830	3.4170				118.875	28.875		
3.40	3.3660	3.4340	3.3320	3.4680				119.000	29.000		
3.45	3.4155	3.4845	3.3810	3.5190				119.125	29.125		
3.50	3.4650	3.5350	3.4300	3.5700				119.250	29.250		
3.55	3.5145	3.5855	3.4790	3.6210				119.375	29.375		
3.60	3.5640	3.6360	3.5280	3.6720				119.500	29.500		
3.65	3.6135	3.6865	3.5770	3.7230				119.625	29.625		
3.70	3.6630	3.7370	3.6260	3.7740				119.750	29.750		
3.75	3.7125	3.7875	3.6750	3.8250				119.875	29.875		
3.80	3.7620	3.8380	3.7240	3.8760				120.000	30.000		
3.85	3.8115	3.8885	3.7730	3.9270				120.125	30.125		
3.90	3.8610	3.9390	3.8220	3.9780				120.250	30.250		
3.95	3.9105	3.9895	3.8710	4.0290				120.375	30.375		
4.00	3.9600	4.0400	3.9200	4.0800	120.500	30.500					
4.05	4.0095	4.0905	3.9690	4.1310	120.625	30.625	1450				
4.10	4.0590	4.1410	4.0180	4.1820	120.750	30.750					
4.15	4.1085	4.1915	4.0670	4.2330	120.875	30.875					
4.20	4.1580	4.2420	4.1160	4.2840	121.000	31.000					
4.25	4.2075	4.2925	4.1650	4.3350	121.125	31.125					
4.30	4.2570	4.3430	4.2140	4.3860	121.250	31.250					
4.35	4.3065	4.3935	4.2630	4.4370	121.375	31.375					
4.40	4.3560	4.4440	4.3120	4.4880	121.500	31.500					
4.45	4.4055	4.4945	4.3610	4.5390	121.625	31.625					
4.50	4.4550	4.5450	4.4100	4.5900	121.750	31.750					
4.55	4.5045	4.5955	4.4590	4.6410	121.875	31.875					
4.60	4.5540	4.6460	4.5080	4.6920	122.000	32.000					
4.65	4.6035	4.6965	4.5570	4.7430	122.125	32.125					
4.70	4.6530	4.7470	4.6060	4.7940	122.250	32.250					
4.75	4.7025	4.7975	4.6550	4.8450	122.375	32.375					
4.80	4.7520	4.8480	4.7040	4.8960	122.500	32.500					
4.85	4.8015	4.8985	4.7530	4.9470	122.625	32.625					
4.90	4.8510	4.9490	4.8020	4.9980	122.750	32.750					
4.95	4.9005	4.9995	4.8510	5.0490	122.875	32.875					
5.00	4.9500	5.0500	4.9000	5.1000	123.000	33.000					



## ■ TEST CIRCUITS

Circuit 1

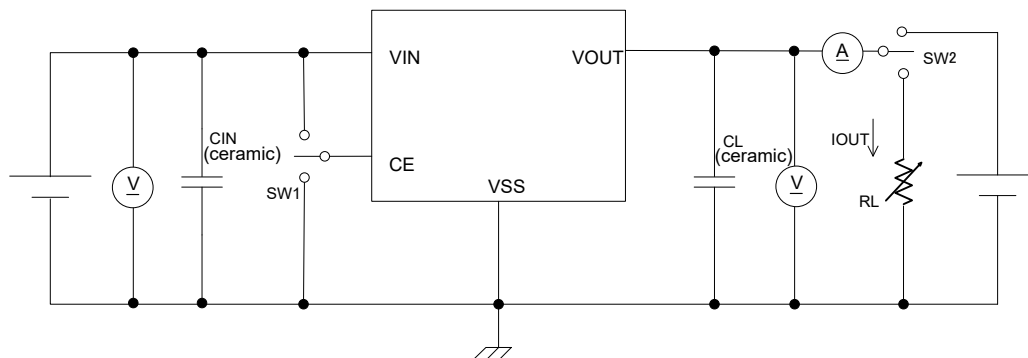

Circuit 2



Circuit 3

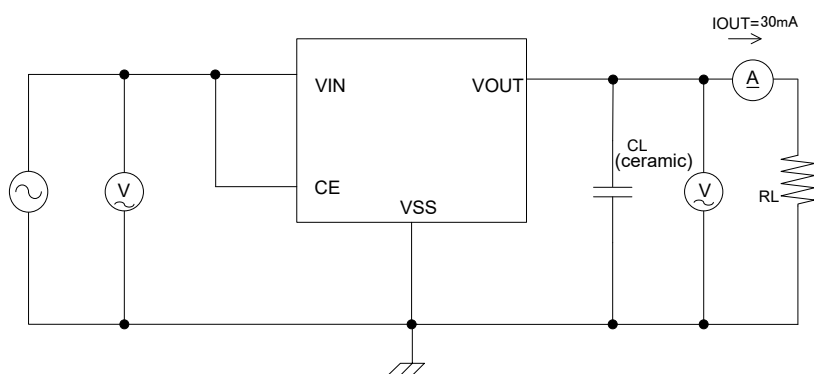

## TEST CIRCUITS (Continued)

Circuit 4



Circuit 5



Circuit 6



## OPERATIONAL EXPLANATION



The voltage divided by resistors R1 & R2 is compared with the internal reference voltage by the error amplifier. The P-channel MOSFET which is connected to the V<sub>OUT</sub> pin is then driven by the subsequent control signal. The output voltage at the V<sub>OUT</sub> pin is controlled & stabilized by a system of negative feedback. The current limit circuit and short protect circuit operate in relation to the level of output current. The GO function monitors the output current and switches the IC between two operating modes according to the level of output current. Further, the IC's internal circuitry can be shutdown via the CE pin's signal.

### <Green Operation>

The XC6220 series always operates in a green operation (GO) mode.

The GO mode enables the IC to switch automatically between the high speed (HS) mode or the power save (PS) mode according to the level of output current. The switching point of the HS mode and the PS mode is fixed inside the IC. When the output current becomes I<sub>GOR</sub>=1.0mA (MIN.) or below, the mode changes automatically to the PS mode after a delay time of hundreds of microseconds. Supply current in light load is greatly reduced. Also when the output current becomes I<sub>GO</sub> 10mA (MAX.) or more, the mode changes automatically to the HS mode and the IC returns to high speed operation.

### <Low ESR capacitor>

The XC6220 series has a built-in phase compensation circuit which means that a stable output voltage is achieved even if the IC is used with low ESR capacitors. In order to ensure stable phase compensation it is recommended that a C<sub>L</sub> capacitor is connected as close as possible to the V<sub>OUT</sub> pin and V<sub>SS</sub> pin. For a stable power supply, please connect an input capacitor (C<sub>IN</sub>) between the V<sub>IN</sub> pin and the V<sub>SS</sub> pin.

Values required for the phase compensation are shown in the chart below. If a loss of the capacitance happens, the stable phase compensation may not be obtained. Please ensure to use a capacitor which does not depend on bias or temperature too much.

### Recommended output capacitor (C<sub>L</sub>)

V <sub>OUT(T)</sub> (V)	OUTPUT CAPACITOR VALUE(C <sub>L</sub> )		
	C <sub>IN</sub> =4.7 μF	C <sub>IN</sub> =10 μF	C <sub>IN</sub> =22 μF
0.80V ~ 0.95V	x	x	22 μF
1.00V ~ 1.45V	47 μF	47 μF	22 μF
1.50V ~ 1.75V	47 μF	22 μF	10 μF
1.80V ~ 2.95V	47 μF	6.8 μF	6.8 μF
3.00V ~ 3.50V	47 μF	4.7 μF	4.7 μF
3.55V ~ 5.00V	47 μF	10 μF	6.8 μF

x No option

### <Current Limiter, Short-Circuit Protection>

The XC6220 series includes a fold-back circuit, which aids the operation of the current limiter and circuit protection. When the load current reaches the current limit level, the fold-back circuit operates and output voltage drops. As a result of this drop in output voltage, output current also decreases. When the output pin is shorted, a current of about 180mA flows.

### <CE Pin>

The IC's internal circuitry can be shutdown via the signal from the CE pin with the XC6220 series. With the XC6220A/C series, output at the V<sub>OUT</sub> pin will be pulled down to the V<sub>SS</sub> level. However, with XC6220B/D series, the C<sub>L</sub> auto-discharge N-channel transistor switch is connected in parallel to R1 and R2 while the power supply is applied to the V<sub>IN</sub> pin. Therefore, the time until the V<sub>OUT</sub> pin reaches the V<sub>SS</sub> level is shortened.

The output voltage of the XC6220A/B series becomes unstable, when the CE pin is open. If this IC is used with the correct output voltage for the CE pin, the logic is fixed and the IC will operate normally. On the other hand, with the XC6220C/D series, the IC operation is stopped when the CE pin is open. However, the CE pin input current may increase as a result of through current in the pull-down resistor (R<sub>CE</sub>) when the IC is under operation.

### XC6220x301



## ■ OPERATIONAL EXPLANATION (Continued)

### <C<sub>L</sub> Discharge Function>

The XC6220B/D series can quickly discharge the electric charge at the output capacitor (C<sub>L</sub>) via the N-channel transistor located between the V<sub>OUT</sub> pin and the V<sub>SS</sub> pin, when a low signal is inputted to the CE pin, which enables the whole IC circuit put into an OFF state (cf. BLOCK DIAGRAM).

(V<sub>OUT</sub> pin voltage) ÷ (N-channel transistor through current) = C<sub>L</sub> discharge resistance (R<sub>DCHG</sub>)

The C<sub>L</sub> auto-discharge resistance value is fixed to 460 Ω (V<sub>IN</sub>=6.0V, V<sub>OUT</sub>=5.0V at TYP.). The discharge time of the output capacitor (C<sub>L</sub>) is set by the C<sub>L</sub> auto-discharge resistance (R<sub>DCHG</sub>) and the output capacitor (C<sub>L</sub>). By setting a time constant of the C<sub>L</sub> auto-discharge resistance value [R<sub>DCHG</sub>] and an output capacitor value (C<sub>L</sub>) as  $\tau$  ( $\tau = C \times R_{DCHG}$ ), the output voltage after discharge via the N-channel transistor is calculated by the following formulas.

$$V = V_{OUT(E)} \times e^{-t/\tau}, \quad \text{or } t = \tau \ln( V_{OUT(E)} / V )$$

where

V : Output voltage after discharge

V<sub>OUT(E)</sub> : Output voltage

t: Discharge time

$\tau$  : C<sub>L</sub> auto-discharge resistance R<sub>DCHG</sub> × Output capacitor (C<sub>L</sub>) value C

### <Inrush Current Prevention>

The XC6220 series includes an inrush current Prevention circuit.

The inrush current protection circuit suppresses inrush current charged to C<sub>L</sub> when the IC starts up to 700 mA (MAX.) for approximately 1ms.

\* Please note that the device can not provide the output current beyond 700 mA for a period of approximately 1ms after the CE pin goes high.

## ■ NOTES ON USE

1. For temporary, transitional voltage drop or voltage rising phenomenon, the IC is liable to malfunction should the ratings be exceeded.
2. Where wiring impedance is high, operations may become unstable due to noise and/or phase lag depending on output current. Please strengthen V<sub>IN</sub> and V<sub>SS</sub> wiring in particular.
3. Please wire the input capacitor (C<sub>IN</sub>) and the output capacitor (C<sub>L</sub>) as close to the IC as possible.
4. As for the XC6220A/C series (semi-custom), the output voltage may float with a leakage current of the driver transistor between V<sub>IN</sub> and V<sub>OUT</sub> and R1+R2 resistance while stand-by (operation stop). Please take consideration of this and check it before use.
5. Torex places an importance on improving our products and their reliability. We request that users incorporate fail-safe designs and post-aging protection treatment when using Torex products in their systems.

## TYPICAL PERFORMANCE CHARACTERISTICS

(1) Output Voltage vs. Output Current

**XC6220x121**



**XC6220x121**



**XC6220x301**



**XC6220x301**

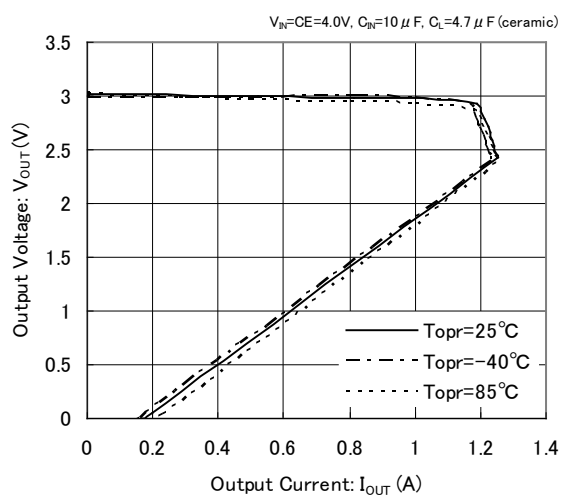

**XC6220x501**



**XC6220x501**

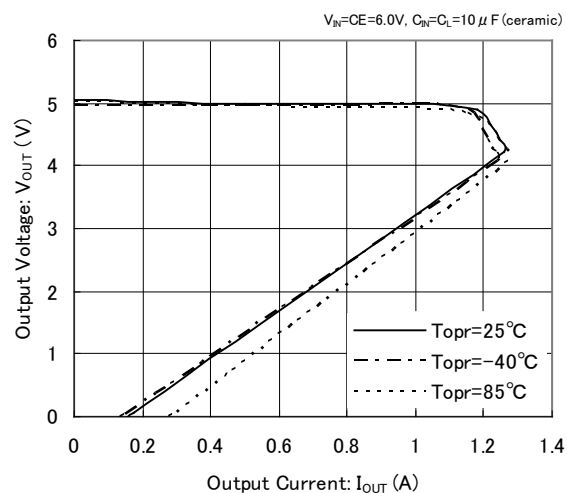

## TYPICAL PERFORMANCE CHARACTERISTICS (Continued)

### (2) Output Voltage vs. Input Voltage

**XC6220x121**



**XC6220x301**

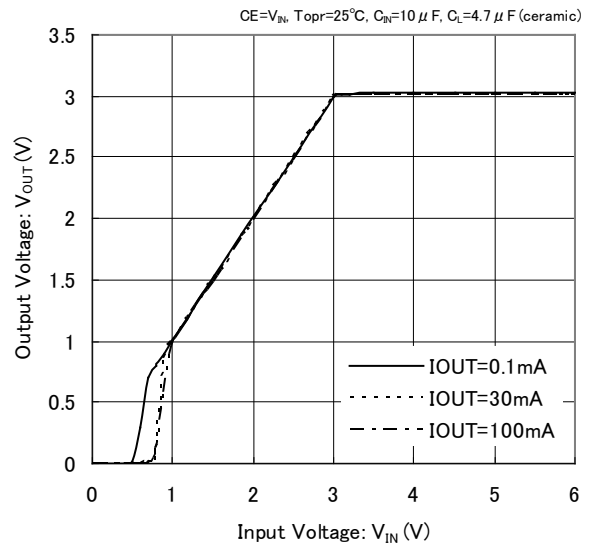

**XC6220x501**



### (3) Dropout Voltage vs. Output Current

**XC6220x121**

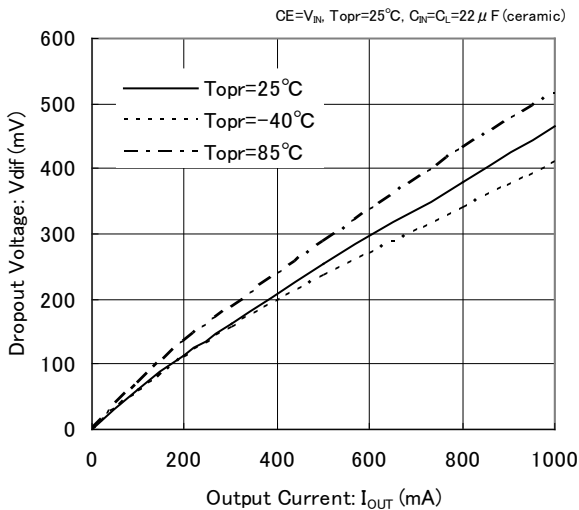

**XC6220x301**

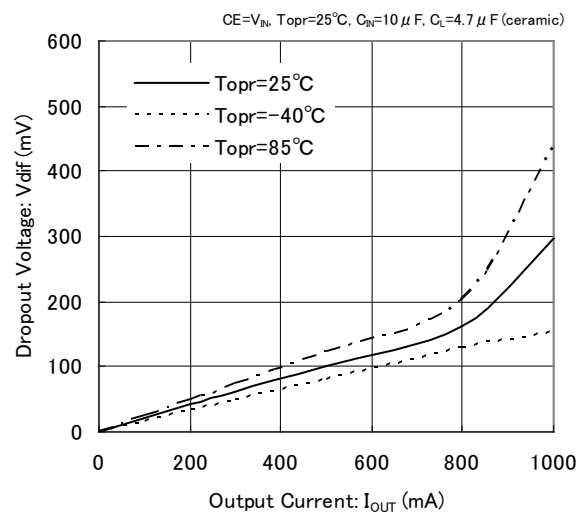

## ■ TYPICAL PERFORMANCE CHARACTERISTICS (Continued)

### (3) Dropout Voltage vs. Output Current

#### XC6220x501



### (4) Output Voltage vs. Ambient Temperature

#### XC6220x121



#### XC6220x301



#### XC6220x501



## TYPICAL PERFORMANCE CHARACTERISTICS (Continued)

(5) Supply Current vs. Input Voltage

**XC6220x121**

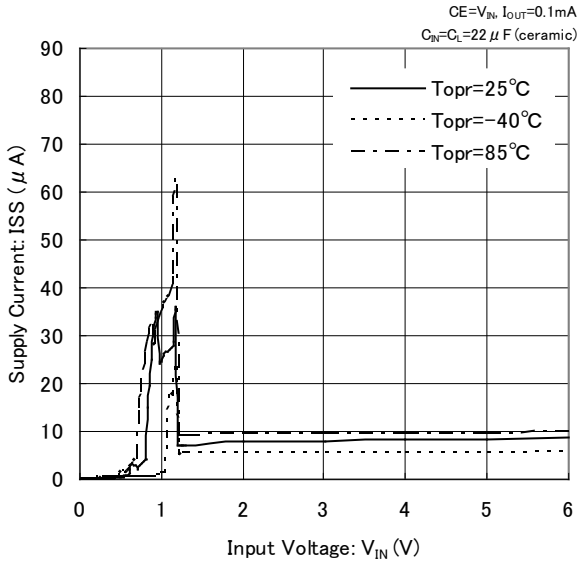

**XC6220B121**



**XC6220x301**



**XC6220x301**

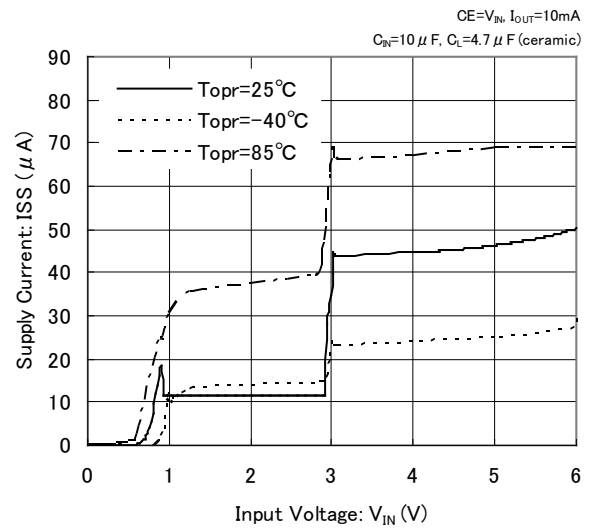

**XC6220x501**

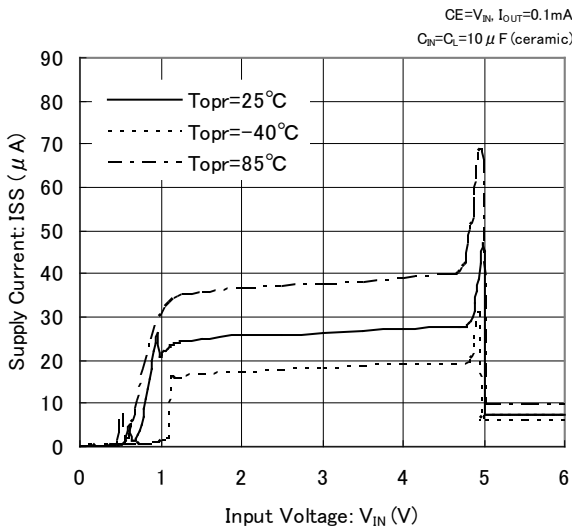

**XC6220x501**





## ■ TYPICAL PERFORMANCE CHARACTERISTICS (Continued)

### (6) PS Switching Delay Time vs. Ambient Temperature



### (7) CL Discharge Resistance vs. Ambient Temperature



### (8) PS/HS Switch Current vs. Ambient Temperature

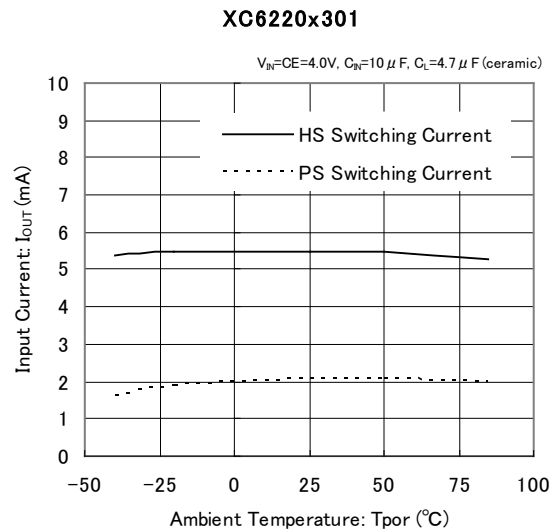

## TYPICAL PERFORMANCE CHARACTERISTICS (Continued)

### (9) Load Transient Response

**XC6220x121**

$V_{IN}=CE=2.2V$ ,  $T_r=T_f=5\mu s$   
 $T_{opr}=25^\circ C$ ,  $C_{IN}=C_L=22\mu F$  (ceramic)

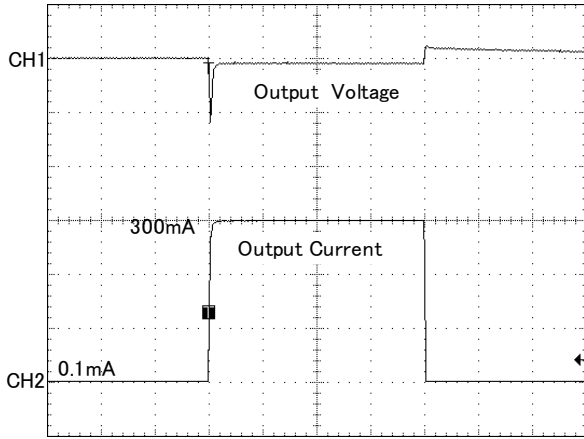

200  $\mu s$ /div

CH1: 100mV/div CH2: 100mA/div

**XC6220x121**

$V_{IN}=CE=2.2V$ ,  $T_r=T_f=5\mu s$   
 $T_{opr}=25^\circ C$ ,  $C_{IN}=C_L=22\mu F$  (ceramic)

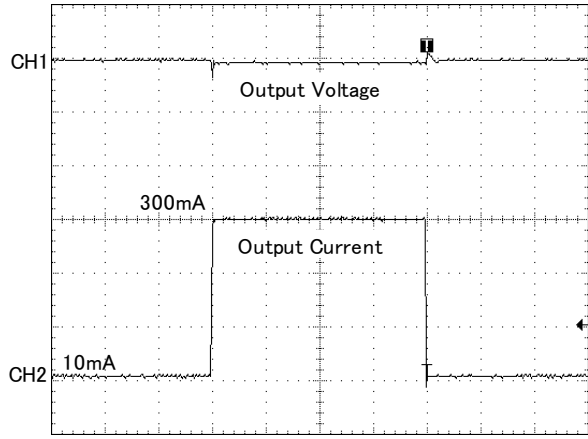

200  $\mu s$ /div

CH1: 100mV/div CH2: 100mA/div

**XC6220x301**

$V_{IN}=CE=4.0V$ ,  $T_r=T_f=5\mu s$   
 $T_{opr}=25^\circ C$ ,  $C_{IN}=10\mu F$ ,  $C_L=4.7\mu F$  (ceramic)

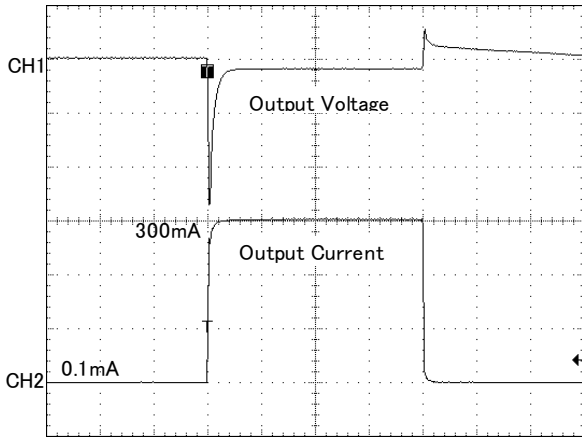

200  $\mu s$ /div

CH1: 100mV/div CH2: 100mA/div

**XC6220x301**

$V_{IN}=CE=4.0V$ ,  $T_r=T_f=5\mu s$   
 $T_{opr}=25^\circ C$ ,  $C_{IN}=10\mu F$ ,  $C_L=4.7\mu F$  (ceramic)

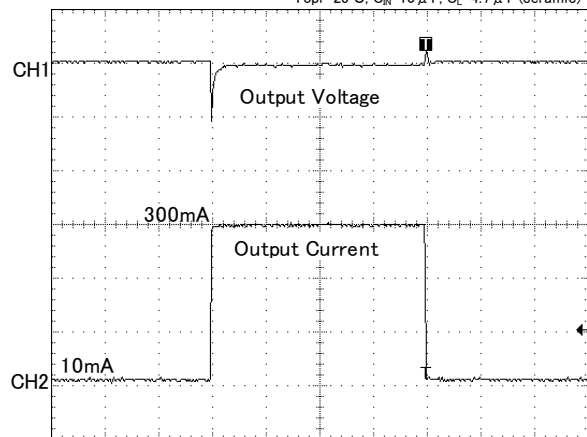

200  $\mu s$ /div

CH1: 100mV/div CH2: 100mA/div

**XC6220x501**

$V_{IN}=CE=6.0V$ ,  $T_r=T_f=5\mu s$   
 $T_{opr}=25^\circ C$ ,  $C_{IN}=C_L=10\mu F$  (ceramic)

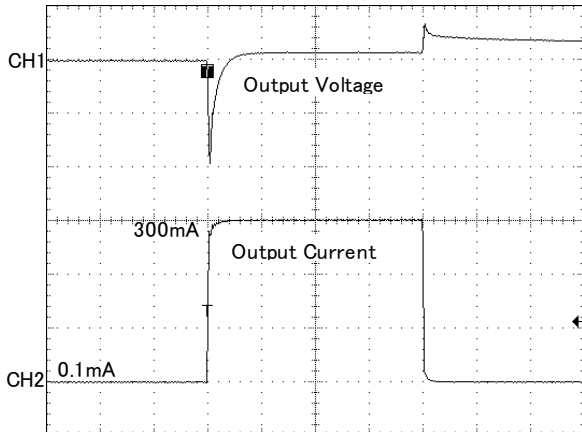

200  $\mu s$ /div

CH1: 100mV/div CH2: 100mA/div

**XC6220x501**

$V_{IN}=CE=6.0V$ ,  $T_r=T_f=5\mu s$   
 $T_{opr}=25^\circ C$ ,  $C_{IN}=C_L=10\mu F$  (ceramic)

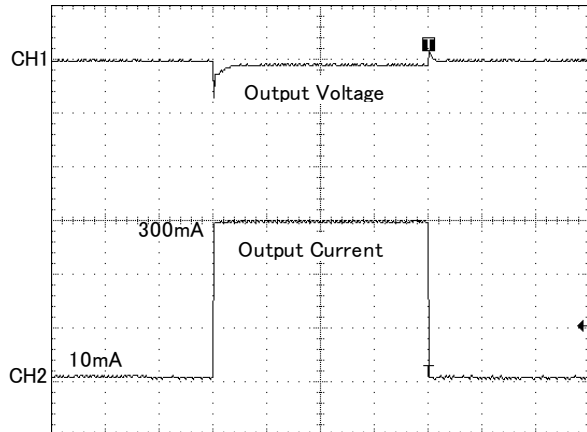

200  $\mu s$ /div

CH1: 100mV/div CH2: 100mA/div

## ■ TYPICAL PERFORMANCE CHARACTERISTICS (Continued)

### (10) Line Transient Response

**XC6220x121**

CE=V<sub>IN</sub>, Tr=Tf=5 μs, I<sub>OUT</sub>=100mA  
T<sub>opr</sub>=25°C, C<sub>IN</sub>=C<sub>L</sub>=22 μF (ceramic)

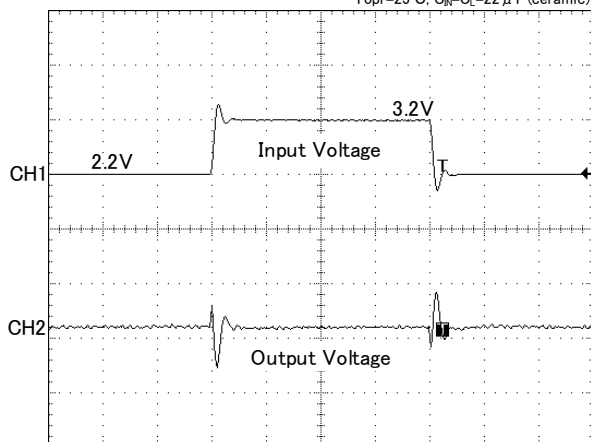

100 μs/div  
CH1: 1V/div CH2: 20mV/div

**XC6220x301**

CE=V<sub>IN</sub>, Tr=Tf=5 μs, I<sub>OUT</sub>=100mA  
T<sub>opr</sub>=25°C, C<sub>IN</sub>=10 μF, C<sub>L</sub>=4.7 μF (ceramic)

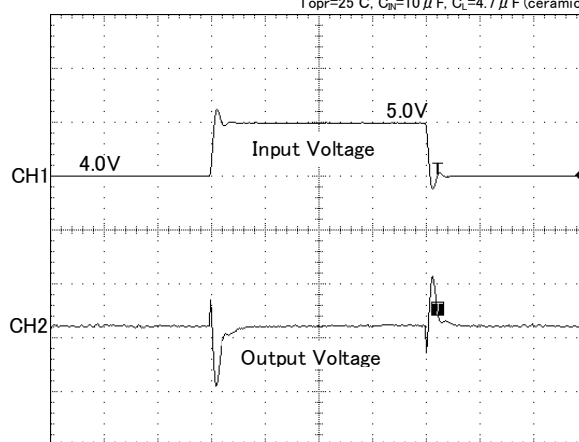

100 μs/div  
CH1: 1V/div CH2: 20mV/div

**XC6220x501**

CE=V<sub>IN</sub>, Tr=Tf=5 μs, I<sub>OUT</sub>=100mA  
T<sub>opr</sub>=25°C, C<sub>IN</sub>=C<sub>L</sub>=22 μF (ceramic)



100 μs/div  
CH1: 500mV/div CH2: 20mV/div

### (11) Input Rise Characteristics

**XC6220x121**

CE=V<sub>IN</sub>, Tr=5 μs, I<sub>OUT</sub>=0.1mA  
T<sub>opr</sub>=25°C, C<sub>L</sub>=22 μF (ceramic)

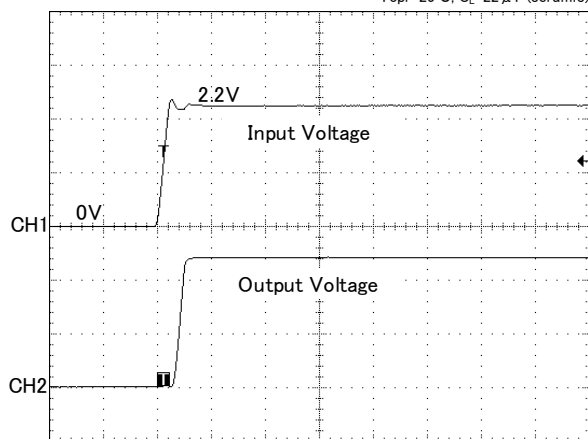

200 μs/div  
CH1: 1V/div CH2: 500mV/div

**XC6220x121**

CE=V<sub>IN</sub>, Tr=5 μs, I<sub>OUT</sub>=300mA  
T<sub>opr</sub>=25°C, C<sub>L</sub>=22 μF (ceramic)

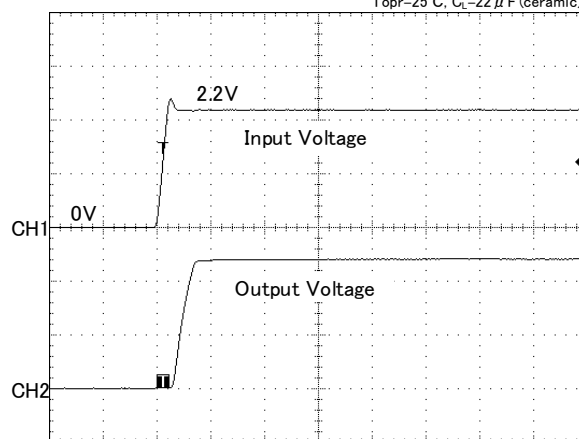

200 μs/div  
CH1: 1V/div CH2: 500mV/div

## TYPICAL PERFORMANCE CHARACTERISTICS (Continued)

### (11) Input Rise Characteristics

**XC6220x301**

CE=V<sub>IN</sub>, Tr=5 μs, I<sub>OUT</sub>=0.1mA  
T<sub>opr</sub>=25°C, C<sub>L</sub>=4.7 μF (ceramic)

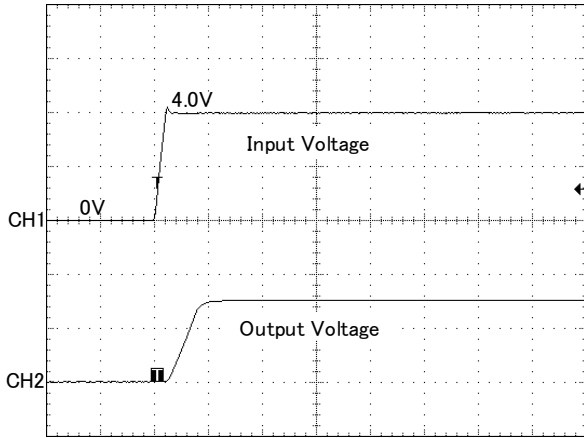

**XC6220x301**

CE=V<sub>IN</sub>, Tr=5 μs, I<sub>OUT</sub>=300mA  
T<sub>opr</sub>=25°C, C<sub>L</sub>=4.7 μF (ceramic)

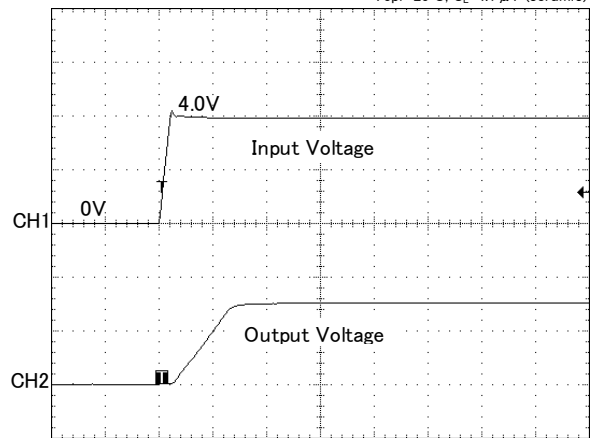

**XC6220x501**

CE=V<sub>IN</sub>, Tr=5 μs, I<sub>OUT</sub>=0.1mA  
T<sub>opr</sub>=25°C, C<sub>L</sub>=22 μF (ceramic)

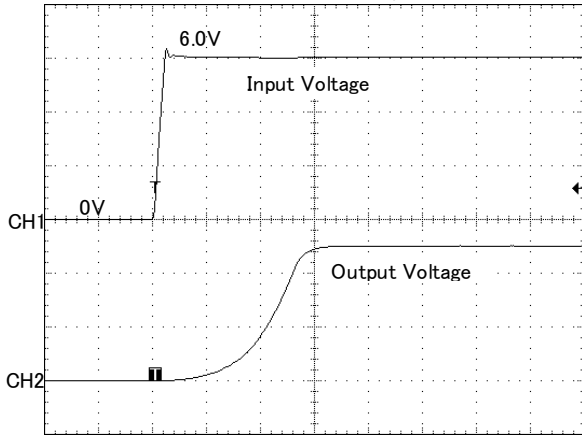

**XC6220x501**

CE=V<sub>IN</sub>, Tr=5 μs, I<sub>OUT</sub>=300mA  
T<sub>opr</sub>=25°C, C<sub>L</sub>=22 μF (ceramic)

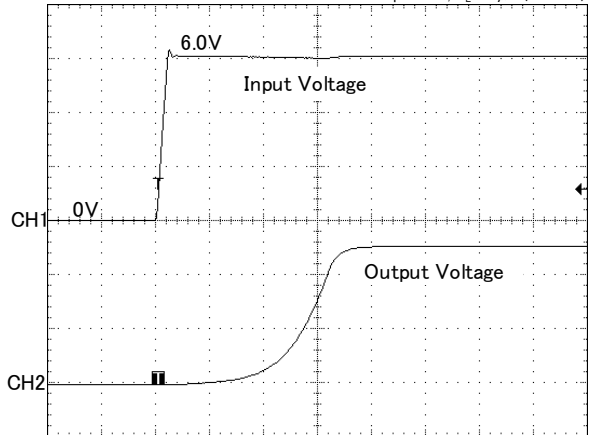

### (12) CE Rise Characteristics

**XC6220x121**

V<sub>IN</sub>=2.2V, Tr=5 μs, I<sub>OUT</sub>=0.1mA  
T<sub>opr</sub>=25°C, C<sub>N</sub>=C<sub>L</sub>=22 μF (ceramic)

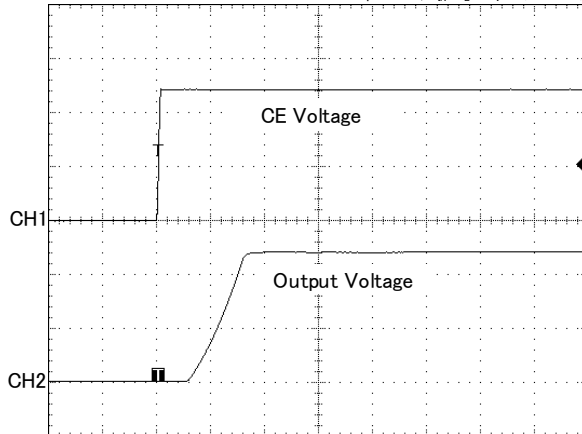

**XC6220x121**

V<sub>IN</sub>=2.2V, Tr=5 μs, I<sub>OUT</sub>=300mA  
T<sub>opr</sub>=25°C, C<sub>N</sub>=C<sub>L</sub>=22 μF (ceramic)

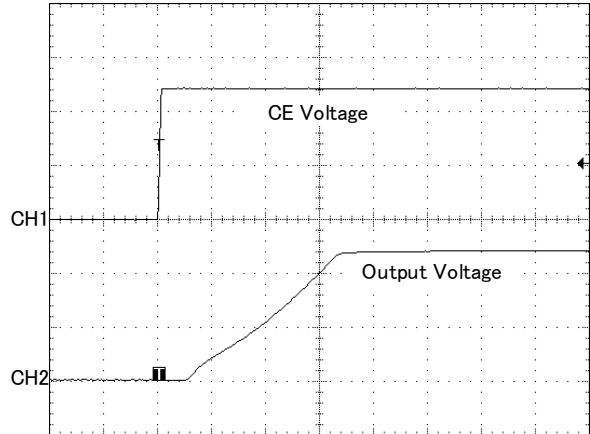

## ■ TYPICAL PERFORMANCE CHARACTERISTICS (Continued)

### (12) CE Rise Characteristics

**XC6220x301**

$V_N=4.0V$ ,  $T_r=5\mu s$ ,  $I_{OUT}=0.1mA$   
 $T_{opr}=25^\circ C$ ,  $C_N=10\mu F$ ,  $C_L=4.7\mu F$  (ceramic)

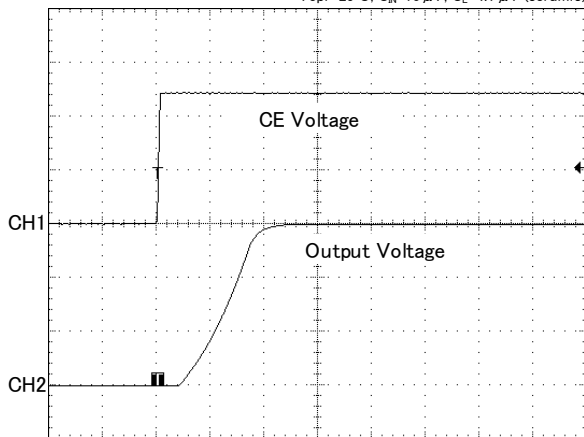

100  $\mu s$ /div  
CH1 : 500mV/div CH2 : 1V/div

**XC6220x301**

$V_N=4.0V$ ,  $T_r=5\mu s$ ,  $I_{OUT}=300mA$   
 $T_{opr}=25^\circ C$ ,  $C_N=10\mu F$ ,  $C_L=4.7\mu F$  (ceramic)

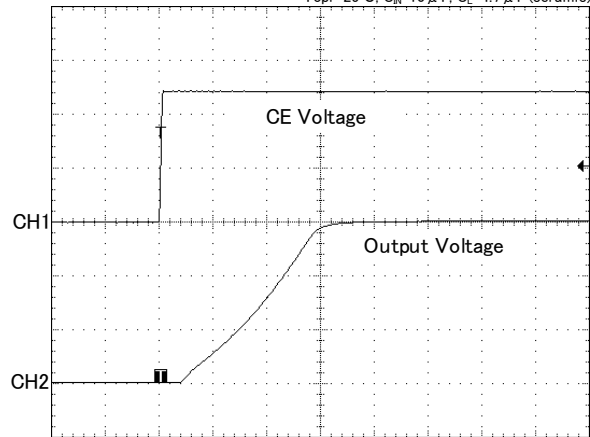

100  $\mu s$ /div  
CH1 : 500mV/div CH2 : 1V/div

**XC6220x501**

$V_N=6.0V$ ,  $T_r=5\mu s$ ,  $I_{OUT}=0.1mA$   
 $T_{opr}=25^\circ C$ ,  $C_N=C_L=10\mu F$  (ceramic)

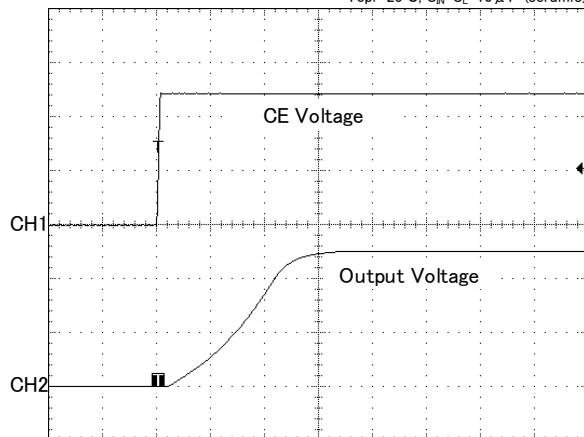

100  $\mu s$ /div  
CH1 : 500mV/div CH2 : 2V/div

**XC6220x501**

$V_N=6.0V$ ,  $T_r=5\mu s$ ,  $I_{OUT}=300mA$   
 $T_{opr}=25^\circ C$ ,  $C_N=C_L=10\mu F$  (ceramic)

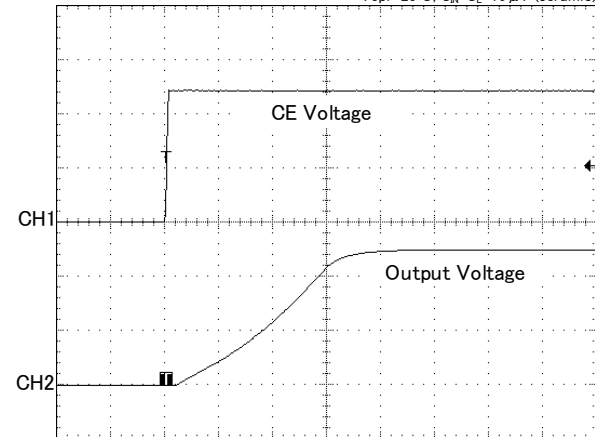

100  $\mu s$ /div  
CH1 : 500mV/div CH2 : 2V/div

### (13) Inrush Current

**XC6220x121**

$V_N=2.2V$ ,  $T_r=5\mu s$   
 $T_{opr}=25^\circ C$ ,  $C_N=C_L=22\mu F$  (ceramic)



100  $\mu s$ /div  
CH1 : 500mV/div CH2 : 1V/div CH3 : 100mA/div

**XC6220x301**

$V_N=4.0V$ ,  $T_r=5\mu s$   
 $T_{opr}=25^\circ C$ ,  $C_N=10\mu F$ ,  $C_L=4.7\mu F$  (ceramic)

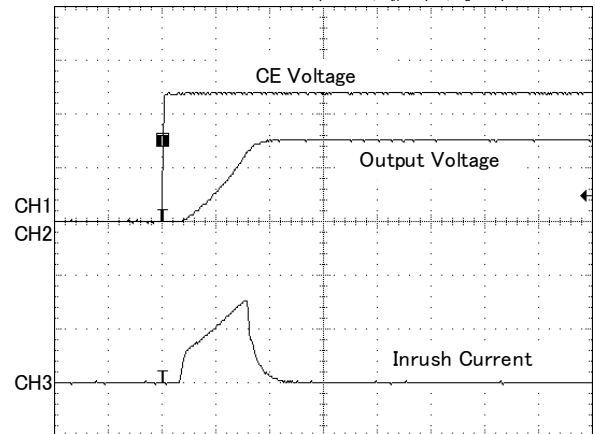

100  $\mu s$ /div  
CH1 : 500mV/div CH2 : 1V/div CH3 : 100mA/div

## TYPICAL PERFORMANCE CHARACTERISTICS (Continued)

### (13) Inrush Current

#### XC6220x501



### (14) CL Discharge Time

#### XC6220x301 (B/D)



#### XC6220x301 (A/C)



### (15) Ripple Rejection Ratio

#### XC6220x121 (HighSpeed mode)



#### XC6220x121 (PowerSave mode)



## ■ TYPICAL PERFORMANCE CHARACTERISTICS (Continued)

### (15) Ripple Rejection Ratio

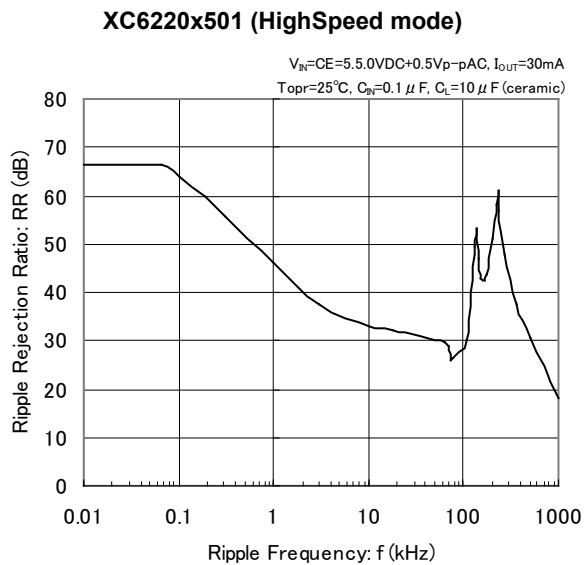

## ■ PACKAGING INFORMATION

For the latest package information go to, [www.torexsemi.com/technical-support/packages](http://www.torexsemi.com/technical-support/packages)

PACKAGE	OUTLINE / LAND PATTERN	THERMAL CHARACTERISTICS	
SOT-25	<a href="#">SOT-25 PKG</a>	Standard Board	<a href="#">SOT-25 Power Dissipation</a>
		JESD51-7 Board	
SOT-89-5	<a href="#">SOT-89-5 PKG</a>	Standard Board	<a href="#">SOT-89-5 Power Dissipation</a>
		JESD51-7 Board	
USP-6C	<a href="#">USP-6C PKG</a>	Standard Board	<a href="#">USP-6C Power Dissipation</a>
		JESD51-7 Board	
SOP-8FD	<a href="#">SOP-8FD PKG</a>	Standard Board	<a href="#">SOP-8FD Power Dissipation</a>
		JESD51-7 Board	



## MARKING RULE

● SOT-25, SOT-89-5, USP6C, SOP-8FD

SOT25

SOT89-5

USP6C

SOP-8FD



① represents product series

MARK	PRODUCT SERIES
H	XC6220*****

② represents type of CE, voltage range, and accuracy

MARK	CE	OUTPUT VOLTAGE RANGE	OUTPUT VOLTAGE ACCURACY	PRODUCT SERIES
0	A	0.8~2.9	1	XC6220A081** ~ XC6220A291**
1	A	0.85~2.95	B	XC6220A08B** ~ XC6220A29B**
2	A	3.0~5.0	1	XC6220A301** ~ XC6220A501**
3	A	3.05~4.95	B	XC6220A30B** ~ XC6220A49B**
4	B	0.8~2.9	1	XC6220B081** ~ XC6220B291**
5	B	0.85~2.95	B	XC6220B08B** ~ XC6220B29B**
6	B	3.0~5.0	1	XC6220B301** ~ XC6220B501**
7	B	3.05~4.95	B	XC6220B30B** ~ XC6220B49B**
8	C	0.8~2.9	1	XC6220C081** ~ XC6220C291**
9	C	0.85~2.95	B	XC6220C08B** ~ XC6220C29B**
A	C	3.0~5.0	1	XC6220C301** ~ XC6220C501**
B	C	3.05~4.95	B	XC6220C30B** ~ XC6220C49B**
C	D	0.8~2.9	1	XC6220D081** ~ XC6220D291**
D	D	0.85~2.95	B	XC6220D08B** ~ XC6220D29B**
E	D	3.0~5.0	1	XC6220D301** ~ XC6220D501**
F	D	3.05~4.95	B	XC6220D30B** ~ XC6220D49B**

③ represents output voltage

MARK	OUTPUT VOLTAGE (V)		MARK	OUTPUT VOLTAGE (V)		MARK	OUTPUT VOLTAGE (V)	
0	—	3.0x	A	1.0x	4.0x	N	2.0x	5.0x
1	—	3.1x	B	1.1x	4.1x	P	2.1x	—
2	—	3.2x	C	1.2x	4.2x	R	2.2x	—
3	—	3.3x	D	1.3x	4.3x	S	2.3x	—
4	—	3.4x	E	1.4x	4.4x	T	2.4x	—
5	—	3.5x	F	1.5x	4.5x	U	2.5x	—
6	—	3.6x	H	1.6x	4.6x	V	2.6x	—
7	—	3.7x	K	1.7x	4.7x	X	2.7x	—
8	0.8x	3.8x	L	1.8x	4.8x	Y	2.8x	—
9	0.9x	3.9x	M	1.9x	4.9x	Z	2.9x	—

④,⑤ represents production lot number

01~09, 0A~0Z, 11~9Z, A1~A9, AA~Z9, ZA~ZZ repeated

(G, I, J, O, Q, W excluded)

\*No character inversion used.