

Low ESR Caps Compatible High Speed LDO Voltage Regulator with ON/OFF Switch

GENERAL DESCRIPTION

The XC6221 series is a high accuracy, low noise, high speed, low dropout CMOS regulator with high ripple rejection. The series includes a reference voltage source, an error amplifier, a current limiter, and a phase compensation circuit.

The CE function enables the entire circuit to be in stand-by state by inputting low level signal. As for the XC6221B/D stand-by mode, the electric charge at the output capacitor (C_L) will be discharged by the internal auto-discharge switch, and as a result the V_{OUT} pin quickly returns to the V_{SS} level. The output stabilization capacitor (C_L) is also compatible with low ESR ceramic capacitors.

Output voltage is selectable in 0.05V increments within a range of 0.80V~5.00V, using the laser trimming technology set in factory.

The current limiter's fold-back circuit also operates as a short circuit protection and an output current limiter at the output pin. The series achieves a fast response with only 25 μ A of low power consumption. Also the series has low dropout voltage characteristics, which is 80mV at $I_{OUT}=100$ mA and $V_{OUT}=3.0$ V.

With the use of small USP-4 and ultra small USPN-4 packages, a small footprint circuit can be designed.

APPLICATIONS

- Smart phones / Mobile phones
- Portable game consoles
- Digital still cameras / Camcorders
- Digital audio equipments
- Mobile devices / terminals

FEATURES

- Maximum Output Current** : 200mA <Up to 250mA (TYP.)>
- Dropout Voltage** : 80mV@ $I_{OUT}=100$ mA, $V_{OUT}=3.0$ V
- Operating Voltage Range** : 1.6V ~ 6.0V
- Output Voltage Range** : 0.80V~5.00V (0.05V increments)
- Accuracy** : $\pm 2\%$ ($V_{OUT} \geq 1.50$ V) (Standard)
 ± 30 mV ($V_{OUT} = 1.45$ V) (Standard)
 $\pm 1\%$ ($V_{OUT} \geq 2.00$ V) (High Accuracy)
 ± 20 mV ($V_{OUT} = 1.95$ V) (High Accuracy)
- Low Power Consumption** : 25 μ A (TYP.)
- Stand-by Current** : Less than 0.1 μ A
- High Ripple Rejection** : 70dB @ 1kHz
- CE Function** : CE Active High
 Standby current below 0.1 μ A
 C_L High-Speed Auto-Discharge (XC6221B/D)
 CE Pin internally pulled-down (XC6221C/D)
- Low ESR Capacitor** : 1.0 μ F ceramic capacitor
- Low Output Noise**
- Operating Ambient Temperature** : -40 ~ +85
- Packages** : USP-4, SOT-25, SSOT-24
 USPN-4
- Environmentally Friendly** : EU RoHS Compliant, Pb Free

TYPICAL APPLICATION CIRCUIT



TYPICAL PERFORMANCE CHARACTERISTICS

Load Transient Response



PIN CONFIGURATION



*It is recommended that the heat dissipation pad of the USP-4 package is soldered by using the reference mount pattern and metal mask pattern for mounting strength. The mount pattern should be electrically opened or connected to the V_{SS} (No.2) pin.

PIN ASSIGNMENT

PIN NUMBER				PIN NAME	FUNCTIONS
USP-4	SOT-25	SSOT-24	USPN-4		
4	1	4	4	V_{IN}	Power Input
1	5	3	1	V_{OUT}	Output
2	2	2	2	V_{SS}	Ground
3	3	1	3	CE	ON/OFF Control
-	4	-	-	NC	No Connection

CE PIN LOGIC CONDITION

PIN NAME	DESIGNATOR	CONDITIONS
CE	H	$1.2V < V_{CE} < 6.0V$
	L	$V_{CE} < 0.3V$

* V_{CE} : CE pin voltage

PIN FUNCTION ASSIGNMENT

XC6221A/B (CE no pull-down resistor)

CE LEVEL	IC OPERATION
HIGH	ON
LOW	OFF
OPEN	Undefined state

XC6221C/D (CE pull-down resistor)

CE LEVEL	IC OPERATION
HIGH	ON
LOW	OFF
OPEN	

PRODUCT CLASSIFICATION

Ordering Information

XC6221 _____ - (*)

DESIGNATOR	ITEM	SYMBOL	DESCRIPTION
	Type of Regulator	A	No CE pull-down resistor without C _L auto discharge
		B	No CE pull-down resistor with C _L auto discharge
		C	CE pull-down resistor without C _L auto discharge
		D	CE pull-down resistor with C _L auto discharge
	Output Voltage	08 ~ 50	ex.) V _{OUT} = 3.00V = 3, = 0
	Output Accuracy	2	+30mV @ 0.80V V _{OUT} 1.40V When 0.1V steps such as V _{OUT} =0.80V =0, =8, =2
			+2% @ V _{OUT} ≥1.50V When 0.1V steps such as V _{OUT} =3.00V =3, =0, =2
		A	+30mV @ 0.85V V _{OUT} 1.45V When 0.05V steps such as V _{OUT} =0.85V =0, =8, =A
			+2% @ V _{OUT} ≥1.55V When 0.05V steps such as V _{OUT} =3.05V =3, =0, =A
		1	+20mV @ 0.80V V _{OUT} 1.90V When 0.1V steps such as V _{OUT} =0.80V =0, =8, =1
			+1% @ V _{OUT} ≥2.00V When 0.1V steps such as V _{OUT} = 3.00V =3, =0, =1
		B	+20mV @ 0.85V V _{OUT} 1.95V When 0.05V steps such as V _{OUT} =0.85V =0, =8, =B
			+1% @ V _{OUT} ≥2.00V When 0.05V steps such as V _{OUT} = 3.05V =3, =0, =B
- (*)	Packages (Order Unit)	GR	USP-4 (3,000/Reel)
		GR-G	USP-4 (3,000/Reel)
		MR	SOT-25 (3,000/Reel)
		MR-G	SOT-25 (3,000/Reel)
		NR	SSOT-24 (3,000/Reel)
		NR-G	SSOT-24 (3,000/Reel)
		7R-G	USPN-4 (5,000/Reel)

(*) The "-G" suffix indicates that the products are Halogen and Antimony free as well as being fully EU RoHS compliant.

(**) The range of the output voltage of USPN-4 package is 1.20V V_{OUT} 5.00V.

BLOCK DIAGRAMS



XC6221A Series



XC6221B Series



XC6221C Series



XC6221D Series

*Diodes inside the circuit are an ESD protection diode and a parasitic diode.

ABSOLUTE MAXIMUM RATINGS

Ta=25					
PARAMETER	SYMBOL	RATINGS	UNITS		
Input Voltage	V _{IN}	V _{SS} -0.3 ~ +6.5	V		
Output Current	I _{OUT}	400 ^(*1)	mA		
Output Voltage	V _{OUT}	V _{SS} - 0.3 ~ V _{IN} + 0.3	V		
CE Input Voltage	V _{CE}	V _{SS} - 0.3 ~ +6.5	V		
Power Dissipation	USP-4	Pd	120	mW	
			1000(PCB mounted) ^(*2)		
			SOT-25		250
			600(PCB mounted) ^(*2)		
			SSOT-24		150
USPN-4	Pd	100	mW		
		600(PCB mounted) ^(*2)			
Operating Ambient Temperature	Topr	- 40 ~ + 85			
Storage Temperature	Tstg	- 55 ~ +125			

*1 I_{OUT} Pd / (V_{IN}-V_{OUT})

*2 These values are example data which is taken with the PCB mounted. Please refer to pages 21 to 24 for details.

ELECTRICAL CHARACTERISTICS

XC6221A/B/C/D series

Ta=25

PARAMETER	SYMBOL	CONDITIONS	MIN.	TYP.	MAX.	UNITS	CIRCUIT
Output Voltage (Standard)	$V_{OUT(E)}$ ^(*2)	$1.50V \leq V_{OUT(T)}$, $V_{CE}=V_{IN}$, $I_{OUT}=10mA$	$\times 0.98$ ^(*3)	$V_{OUT(T)}$ ^(*4)	$\times 1.02$ ^(*3)	V	
		$V_{OUT(T)} \leq 1.45V$, $V_{CE}=V_{IN}$, $I_{OUT}=10mA$	-0.03 ^(*3)		+0.03 ^(*3)		
Output Voltage (High Accuracy)	$V_{OUT(E)}$ ^(*2)	$2.00V \leq V_{OUT(T)}$, $V_{CE}=V_{IN}$, $I_{OUT}=10mA$	$\times 0.99$ ^(*3)	$V_{OUT(T)}$ ^(*4)	$\times 1.01$ ^(*3)	V	
		$V_{OUT(T)} \leq 1.95V$, $V_{CE}=V_{IN}$, $I_{OUT}=10mA$	-0.02 ^(*3)		+0.02 ^(*3)		
Output Current	I_{OUTMAX}	$V_{CE}=V_{IN}$, $V_{IN}=V_{OUT(T)}+1.0V$, $0.80V \leq V_{OUT(T)} \leq 5.00V$	200	250	-	mA	
Load Regulation	ΔV_{OUT}	$V_{CE}=V_{IN}$, $0.1mA \leq I_{OUT} \leq 100mA$	-	10	40	mV	
Dropout Voltage ^(*5)	Vdif	$V_{CE}=V_{IN}$, $I_{OUT}=100mA$	Refer to the voltage chart			mV	
Supply Current	I_{DD}	$V_{CE}=V_{IN}$, $V_{IN}=V_{OUT(T)}+1.0V$	-	25	50	μA	
Standby Current	I_{STB}	$V_{IN}=6.0V$, $V_{CE}=V_{SS}$	-	0.01	0.10	μA	
Line Regulation	$\frac{\Delta V_{OUT}}{(\Delta V_{IN} \cdot V_{OUT})}$	$V_{OUT(T)}+0.5V$ $V_{IN} 6.0V$ $1.10V \leq V_{OUT(T)}$, $V_{CE}=V_{IN}$, $I_{OUT}=10mA$	-	0.01	0.20	%V	
		$1.6V \leq V_{IN} \leq 6.0V$ $V_{OUT(T)} 1.05V$, $V_{CE}=V_{IN}$, $I_{OUT}=10mA$					
Input Voltage	V_{IN}		1.6	-	6.0	V	
Output Voltage Temperature Characteristics	$\frac{\Delta V_{OUT}}{(\Delta T_{opr} \cdot V_{OUT})}$	$V_{CE}=V_{IN}$, $I_{OUT}=30mA$, $-40 \leq T_{opr} \leq 85$	-	± 100	-	ppm/	
Ripple Rejection Rate	PSRR	$V_{IN}=5.75V_{DC}+0.5V_{p-pAC}$ $4.75V \leq V_{OUT(T)}$ $V_{CE}=V_{IN}$, $I_{OUT}=30mA$, $f=1kHz$	-	60	-	dB	
		$V_{IN}=(V_{OUT(T)}+1.0)V_{DC}+0.5V_{p-pAC}$ $4.05V \leq V_{OUT(T)} \leq 4.70V$ $V_{CE}=V_{IN}$, $I_{OUT}=30mA$, $f=1kHz$					
		$V_{IN}=(V_{OUT(T)}+1.0)V_{DC}+0.5V_{p-pAC}$ $0.85V \leq V_{OUT(T)} \leq 4.00V$ $V_{CE}=V_{IN}$, $I_{OUT}=30mA$, $f=1kHz$					
		$V_{IN}=1.85V_{DC}+0.5V_{p-pAC}$ $V_{OUT(T)}=0.80V$ $V_{CE}=V_{IN}$, $I_{OUT}=30mA$, $f=1kHz$					
Limit Current	I_{LIM}	$V_{CE}=V_{IN}$	200	250	-	mA	
Short Current	I_{SHORT}	$V_{CE}=V_{IN}$, V_{OUT} is short-circuited at the V_{SS} level	-	30	-	mA	
CE High Level Voltage	V_{CEH}		1.2	-	6.0	V	
CE Low Level Voltage	V_{CEL}		-	-	0.3	V	
CE High Level Current	I_{CEH}	$V_{CE}=V_{IN}$ (XC6221A/B)	-0.1	-	0.1	μA	
		$V_{CE}=6.0V$ (XC6221C/D)	1.03	-	2.37		
CE Low Level Current	I_{CEL}	$V_{CE}=V_{SS}$	-0.1	-	0.1	μA	
CL Auto-Discharge Resistance ^(*8)	R_{DCHG}	$V_{IN}=6.0V$, $V_{OUT}=4.0V$, $V_{CE}=V_{SS}$	-	780	-		

NOTE:

- * 1: Unless otherwise stated regarding input voltage conditions, $V_{IN}=V_{OUT(T)} + 1.0V$.
- * 2: $V_{OUT(E)}$ = Effective output voltage
(The output voltage when an amply stabilized " $V_{OUT(T)} + 1.0V$ " is provided at the V_{IN} pin while maintaining a certain I_{OUT} value.)
- * 3: The relation between $V_{OUT(E)}$ and $V_{OUT(T)}$ is shown in the voltage chart E-0 and E-1.
- * 4: $V_{OUT(T)}$ = Nominal output voltage
- * 5: $V_{dif} = \{V_{IN1}^{(*)} - V_{OUT1}^{(*)}\}$
- * 6: V_{OUT1} is the voltage equal to 98% of the normal output voltage when amply stabilized $V_{OUT(T)}+1.0V$ are input at the V_{IN} pin.
- * 7: V_{IN1} is the input voltage when V_{OUT1} appears at the V_{OUT} pin while input voltage is gradually decreased.
- * 8: For the XC6221B/D series only. The XC6221A/C series discharges by resistors R1 and R2 only as shown in the block diagrams.
- * 9: For operating supply current of the XC6221C/D, a current through the pull-down resistor should be considered in addition to the supply current value mentioned above.

OUTPUT VOLTAGE CHART

NOMINAL OUTPUT VOLTAGE (V)	OUTPUT VOLTAGE (Standard) $V_{OUT(E)}$ (V)		OUTPUT VOLTAGE (High Accuracy) $V_{OUT(E)}$ (V)		DROPOUT VOLTAGE V_{dif} (mV)	
	MIN.	MAX.	MIN.	MAX.	TYP.	MAX.
0.80	0.7700	0.8300	0.7800	0.8200	500	850
0.85	0.8200	0.8800	0.8300	0.8700		
0.90	0.8700	0.9300	0.8800	0.9200	410	750
0.95	0.9200	0.9800	0.9300	0.9700		
1.00	0.9700	1.0300	0.9800	1.0200	330	650
1.05	1.0200	1.0800	1.0300	1.0700		
1.10	1.0700	1.1300	1.0800	1.1200		
1.15	1.1200	1.1800	1.1300	1.1700		
1.20	1.1700	1.2300	1.1800	1.2200	230	410
1.25	1.2200	1.2800	1.2300	1.2700		
1.30	1.2700	1.3300	1.2800	1.3200		
1.35	1.3200	1.3800	1.3300	1.3700		
1.40	1.3700	1.4300	1.3800	1.4200	200	360
1.45	1.4200	1.4800	1.4300	1.4700		
1.50	1.4700	1.5300	1.4800	1.5200	180	290
1.55	1.5200	1.5800	1.5300	1.5700		
1.60	1.5700	1.6300	1.5800	1.6200	160	250
1.65	1.6200	1.6800	1.6300	1.6700		
1.70	1.6700	1.7300	1.6800	1.7200		
1.75	1.7200	1.7800	1.7300	1.7700		
1.80	1.7700	1.8300	1.7800	1.8200	125	210
1.85	1.8200	1.8800	1.8300	1.8700		
1.90	1.8700	1.9300	1.8800	1.9200		
1.95	1.9200	1.9800	1.9300	1.9700		
2.00	1.9600	2.0400	1.9800	2.0200	115	195
2.05	2.0090	2.0910	2.0295	2.0705		
2.10	2.0850	2.1420	2.0790	2.1210		
2.15	2.1070	2.1930	2.1285	2.1715		
2.20	2.1560	2.2440	2.1780	2.2220		
2.25	2.2050	2.2950	2.2275	2.2725		
2.30	2.2540	2.3460	2.2770	2.3230		
2.35	2.3030	2.3970	2.3265	2.3735		
2.40	2.3520	2.4480	2.3760	2.4240		
2.45	2.4010	2.4990	2.4255	2.4745		
2.50	2.4500	2.5500	2.4750	2.5250		
2.55	2.4990	2.6010	2.5245	2.5755		
2.60	2.5480	2.6520	2.5740	2.6260		
2.65	2.5970	2.7030	2.6235	2.6765		
2.70	2.6460	2.7540	2.6730	2.7270		
2.75	2.6950	2.8050	2.7225	2.7775		
2.80	2.7440	2.8560	2.7720	2.8280		
2.85	2.7930	2.9070	2.8215	2.8785		
2.90	2.8420	2.9580	2.8710	2.9290		
2.95	2.8910	3.0090	2.9205	2.9795		

* The range of the output voltage of USPN-4 package is 1.20V $V_{OUT(T)}$ 5.00V.

OUTPUT VOLTAGE CHART (Continued)

NOMINAL OUTPUT VOLTAGE (V)	OUTPUT VOLTAGE (Standard) $V_{OUT(E)}$ (V)		OUTPUT VOLTAGE (High Accuracy) $V_{OUT(E)}$ (V)		DROPOUT VOLTAGE V_{dif} (mV)	
	MIN.	MAX.	MIN.	MAX.	TYP.	MAX.
3.00	2.9400	3.0600	2.9700	3.0300	80	140
3.05	2.8990	3.1100	3.0195	3.0805		
3.10	3.0380	3.1620	3.0690	3.1310		
3.15	3.0870	3.2130	3.1185	3.1815		
3.20	3.1360	3.2640	3.1680	3.2320		
3.25	3.1850	3.3150	3.2175	3.2825		
3.30	3.2340	3.3660	3.2670	3.3330		
3.35	3.2830	3.4170	3.3165	3.3835		
3.40	3.3320	3.4680	3.3660	3.4340		
3.45	3.3810	3.5190	3.4155	3.4845		
3.50	3.4300	3.5700	3.4650	3.5350		
3.55	3.4790	3.6210	3.5145	3.5855		
3.60	3.5280	3.6720	3.5640	3.6360		
3.65	3.5770	3.7230	3.6135	3.6855		
3.70	3.6260	3.7740	3.6630	3.7370		
3.75	3.6750	3.8250	3.7125	3.7875		
3.80	3.7240	3.8760	3.7620	3.8380		
3.85	3.7730	3.9270	3.8115	3.8885		
3.90	3.8220	3.9780	3.8610	3.9390		
3.95	3.8710	4.0290	3.9105	3.9895		
4.00	3.9200	4.0800	3.9600	4.0400		
4.05	3.9690	4.1310	4.0095	4.0905		
4.10	4.0180	4.1820	4.0590	4.1410		
4.15	4.0670	4.2330	4.1085	4.1915		
4.20	4.1160	4.2840	4.1580	4.2420		
4.25	4.1650	4.3350	4.2075	4.2925		
4.30	4.2140	4.3860	4.2570	4.3430		
4.35	4.2630	4.4370	4.3065	4.3935		
4.40	4.3120	4.4880	4.3560	4.4440		
4.45	4.3610	4.5390	4.4055	4.4945		
4.50	4.4100	4.5900	4.4550	4.5450		
4.55	4.4590	4.6410	4.5045	4.5955		
4.60	4.5080	4.6920	4.5540	4.6460		
4.65	4.5570	4.7430	4.6035	4.6965		
4.70	4.6060	4.7940	4.6530	4.7470		
4.75	4.6550	4.8450	4.7025	4.7975		
4.80	4.7040	4.8960	4.7520	4.8480		
4.85	4.7530	4.9470	4.8015	4.8985		
4.90	4.8020	4.9980	4.8510	4.9490		
4.95	4.8510	5.0490	4.9005	4.9995		
5.00	4.9000	5.1000	4.9500	5.0500		

OPERATIONAL EXPLANATION

<Output Voltage Control>

The voltage divided by resistors R1 & R2 is compared with the internal reference voltage by the error amplifier. The P-channel MOSFET connected to the V_{OUT} pin, is then driven by the subsequent output signal. The output voltage at the V_{OUT} pin is controlled & stabilized by a system of negative feedback. The current limit circuit and short protect circuit operate in relation to the level of output current. Further, the IC's internal circuitry can be shutdown via the CE pin's signal.



<Input and Output Capacitors>

The XC6221 needs an output capacitor C_L for phase compensation. Values required for the phase compensation are shown in the chart below. If a loss of the capacitance happens, the stable phase compensation may not be obtained. Please ensure to use a capacitor which does not depend on bias or temperature too much. For a stable power input, please connect an input capacitor C_{IN} of 1.0 μF between the V_{IN} pin and the V_{SS} pin.

Except USPN-4

OUTPUT VOLTAGE (V)	OUTPUT CAPACITOR VALUE
0.80V ~ 1.15V	C _L 4.7 μF
1.20V ~ 1.35V	C _L 2.2 μF
1.40V ~ 4.00V	C _L 1.0 μF
4.05V ~ 5.00V	C _L 2.2 μF

USPN-4

OUTPUT VOLTAGE (V)	OUTPUT CAPACITOR VALUE
1.20V ~ 4.00V	C _L 2.2μF
4.05V ~ 5.00V	C _L 4.7μF

<C_L Auto-Discharge Function>

XC6221B/D series can discharge the electric charge in the output capacitor (C_L), when a low signal to the CE pin, which enables the whole IC circuit to be turned off, is inputted via the N-channel transistor and C_L auto-discharge resistance (R_{DCHG}) located between the V_{OUT} pin and the V_{SS} pin (cf. BLOCK DIAGRAM). The C_L auto-discharge resistance (R_{DCHG}) value is set at 780 (V_{OUT}=4.0V @ V_{IN}=6.0V at typical). The discharge time of the output capacitor (C_L) is set by the C_L auto-discharge resistance (R_{DCHG}) and the output capacitor (C_L). By setting the time constant of the C_L auto-discharge resistance value [R_{DCHG}] and the output capacitor value (C_L) as (τ = C_L × R_{DCHG}), the output voltage after discharge via the N-channel transistor is calculated by the following formula.

$$V = V_{OUT(E)} \times e^{-t/\tau}, \text{ or } t = \ln(V / V_{OUT(E)}) \times \tau$$

where

V : Output voltage after discharge

V_{OUT(E)} : Output voltage

t : Discharge time

τ : C_L auto-discharge resistance R_{DCHG} × Output capacitor value C_L

OPERATIONAL EXPLANATION (Continued)

<Current Limiter, Short-Circuit Protection>

The XC6221 series' fold-back circuit operates as an output current limiter and a short protection circuit for the output pin. When the load current reaches the current limit level, the fixed current limiter circuit operates and output voltage drops. When the output pin is short-circuited to the V_{SS} pin, the current falls and reaches about 30mA.

<CE Pin>

The XC6221 internal circuitry can be shutdown via the CE pin signal. In shutdown mode, output at the V_{OUT} pin will be pulled down to the V_{SS} level via R1 & R2. However, with the XC6221B/D series, the C_L auto-discharge resistor is connected in parallel to R1 and R2 while the power supply is applied to the V_{IN} pin. Therefore, time until the V_{OUT} pin reaches the V_{SS} level is shorter. For the XC6221A/B, the output voltage becomes unstable, when the CE pin is left open. For the XC6221C/D, the output voltage becomes V_{SS} level because the CE pin is short-circuited to V_{SS} via an internal pull-down resistor. However, the CE input current will be increased via a pull-down resistor when the IC operates. If this IC is used with the correct output voltage for the CE pin, the logic is fixed and the IC will operate normally. However, the supply current may increase as a result of shoot-through current in the IC's internal circuitry when a medium voltage is input.

NOTES ON USE

1. Please use this IC within the stated maximum ratings. For temporary, transitional voltage drop or voltage rising phenomenon, the IC is liable to malfunction should the ratings be exceeded.
2. Where wiring impedance is high, operations may become unstable due to noise and/or phase lag depending on output current. Please wire the input capacitor (C_{IN}) and the output capacitor (C_L) as close to the IC as possible.
3. Torex places an importance on improving our products and its reliability. However, by any possibility, we would request user fail-safe design and post-aging treatment on system or equipment.

TEST CIRCUITS

Circuit 1: Output Voltage, Output Current, Dropout Voltage, Input/Operating Voltage, Line Regulation, Load Regulation, Current Limit, Short Current, CL Discharge Resistance



Circuit 2: Supply Current, Stand-by Current



Circuit 3: Ripple Rejection Rate



TEST CIRCUITS (Continued)

Circuit 4: CE "H" "L" Level Voltage, CE "H" "L" Level Current



TYPICAL PERFORMANCE CHARACTERISTICS

(1) Output Voltage vs. Output Current

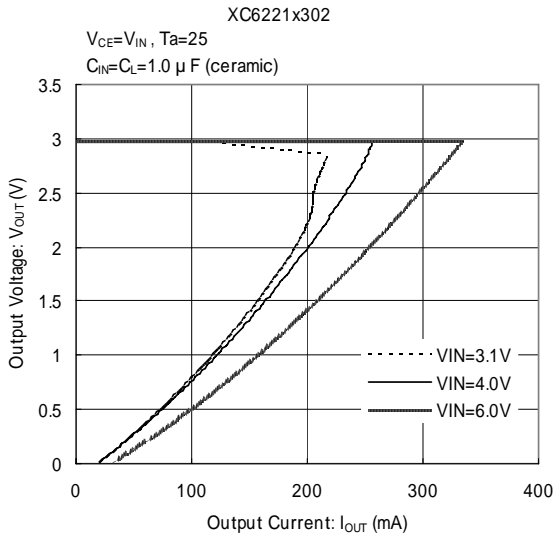

(2) Output Voltage vs. Input Voltage



TYPICAL PERFORMANCE CHARACTERISTICS (Continued)

(2) Output Voltage vs. Input Voltage (Continued)



(3) Dropout Voltage vs. Output Current



(4) Output Voltage vs. Ambient Temperature

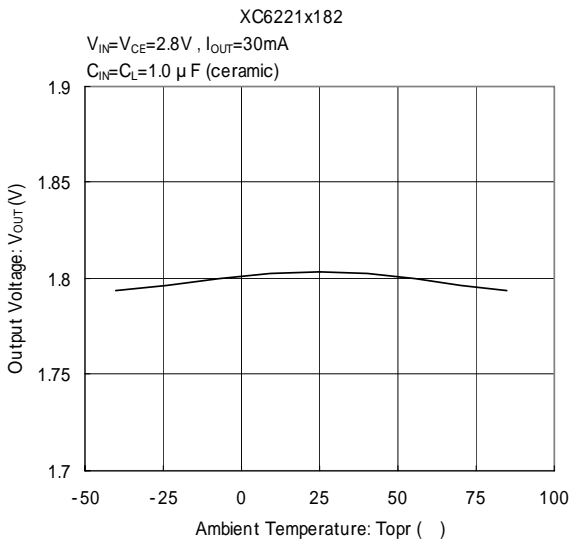

TYPICAL PERFORMANCE CHARACTERISTICS (Continued)

(5) Supply Current vs. Input Voltage



(6) CL-Discharge Resistance vs. Ambient Temperature



(7) Load Transient Response



TYPICAL PERFORMANCE CHARACTERISTICS (Continued)

(8) Line Transient Response



TYPICAL PERFORMANCE CHARACTERISTICS (Continued)

(9) Input Rise Characteristics



TYPICAL PERFORMANCE CHARACTERISTICS (Continued)

(10) CE Rise Characteristics

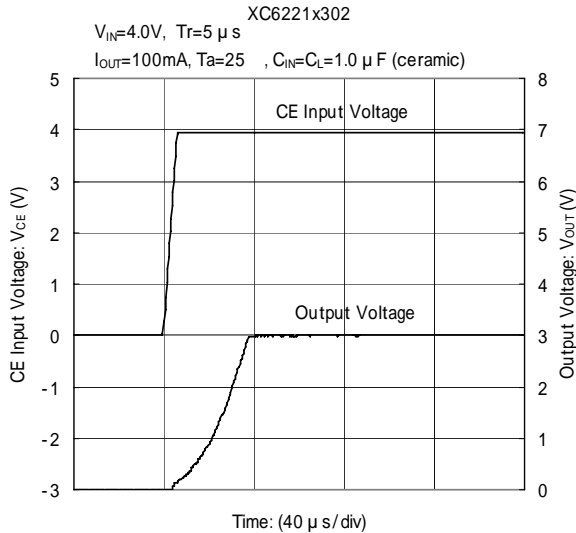
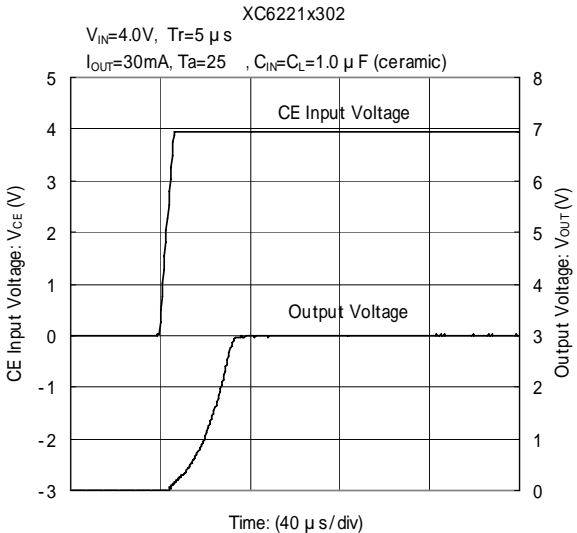
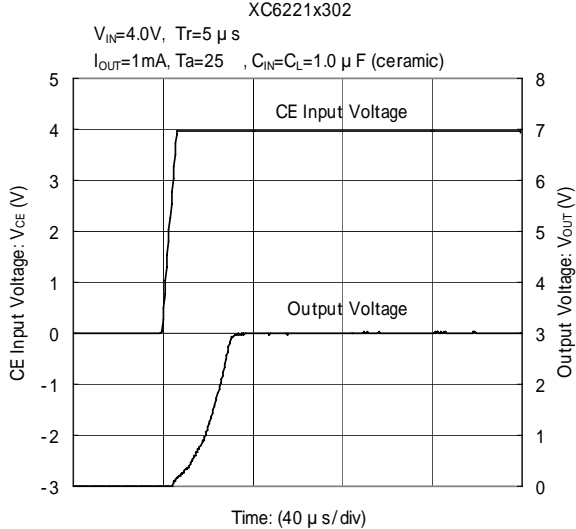
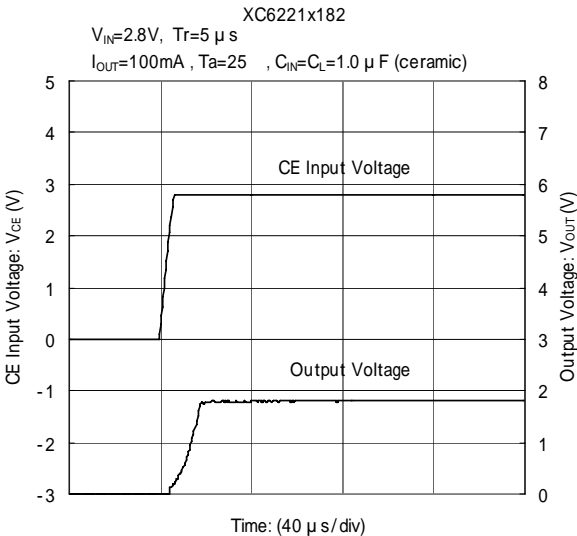
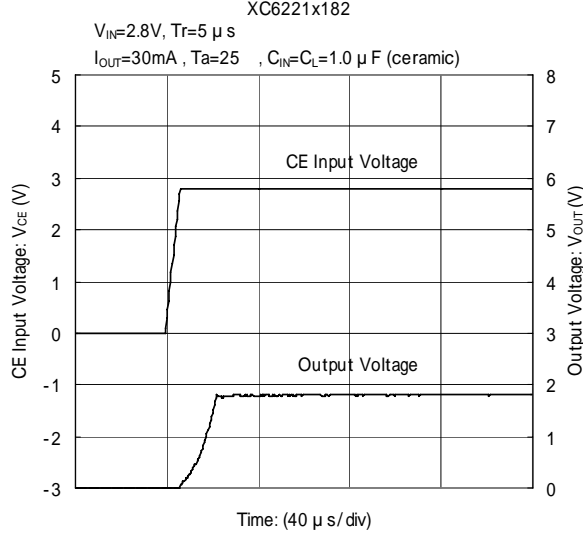
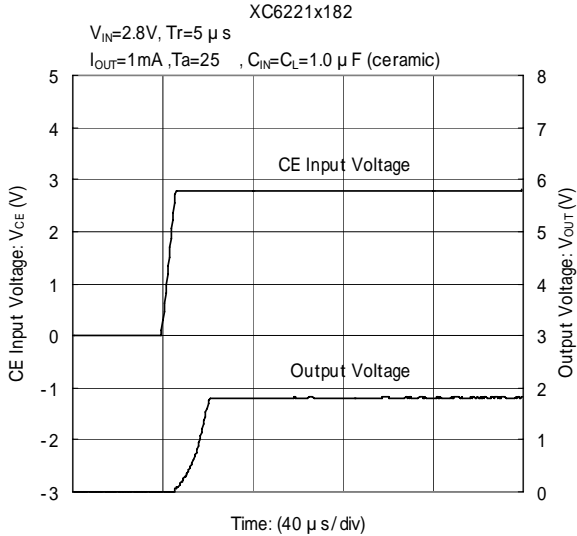

TYPICAL PERFORMANCE CHARACTERISTICS (Continued)

(11) Ripple Rejection Rate



PACKAGING INFORMATION (Continued)

USP-4 Reference Pattern Layout



USP-4 Reference Metal Mask Design



USPN-4 Reference Pattern Layout

(unit : mm)



USPN-4 Reference Metal Mask Design

(unit : mm)



PACKAGING INFORMATION (Continued)

USP-4 Power Dissipation

Power dissipation data for the USP-4 is shown in this page.
The value of power dissipation varies with the mount board conditions.
Please use this data as one of reference data taken in the described condition.

1. Measurement Condition (Reference data)

Condition: Mount on a board
Ambient: Natural convection
Soldering: Lead (Pb) free
Board: Dimensions 40 x 40 mm (1600 mm² in one side)
Copper (Cu) traces occupy 50% of the board area
In top and back faces
Package heat-sink is tied to the copper traces
Material: Glass Epoxy (FR-4)
Thickness: 1.6 mm
Through-hole: 4 x 0.8 Diameter



Evaluation Board (Unit : mm)

2. Power Dissipation vs. Ambient temperature

Board Mount ($T_j \text{ max} = 125 \text{ }^\circ\text{C}$)

Ambient Temperature ($^\circ\text{C}$)	Power Dissipation Pd (mW)	Thermal Resistance ($^\circ\text{C/W}$)
25	1000	100.00
85	400	



PACKAGING INFORMATION (Continued)

- SOT-25 Power Dissipation

Power dissipation data for the SOT-25 is shown in this page.
 The value of power dissipation varies with the mount board conditions.
 Please use this data as one of reference data taken in the described condition.

1. Measurement Condition (Reference data)

- Condition : Mount on a board
- Ambient : Natural convection
- Soldering : Lead (Pb) free
- Board : Dimensions 40×40mm (1600mm² in one side)
- Copper (Cu) traces occupy 50% of the board area
- In top and back faces
- Package heat-sink is tied to the copper traces
- (Board of SOT-26 is used)
- Material : Glass Epoxy (FR-4)
- Thickness : 1.6mm
- Through-hole : 4 x 0.8 Diameter

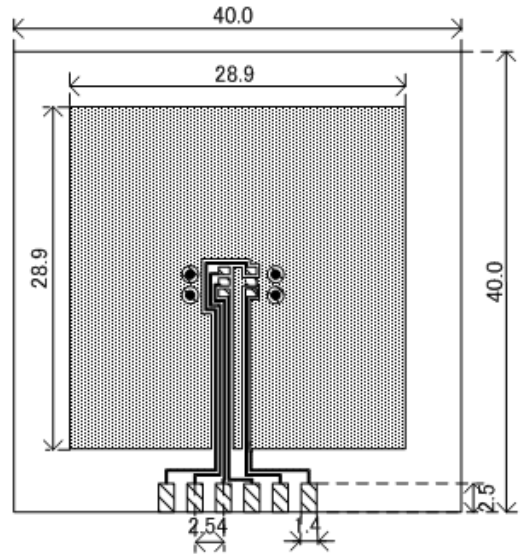

Evaluation Board (Unit: mm)

2. Power Dissipation vs. Ambient temperature

Board Mount (T_j max = 125 °C)

Ambient Temperature (°C)	Power Dissipation Pd (mW)	Thermal Resistance (°C/W)
25	600	166.67
85	240	

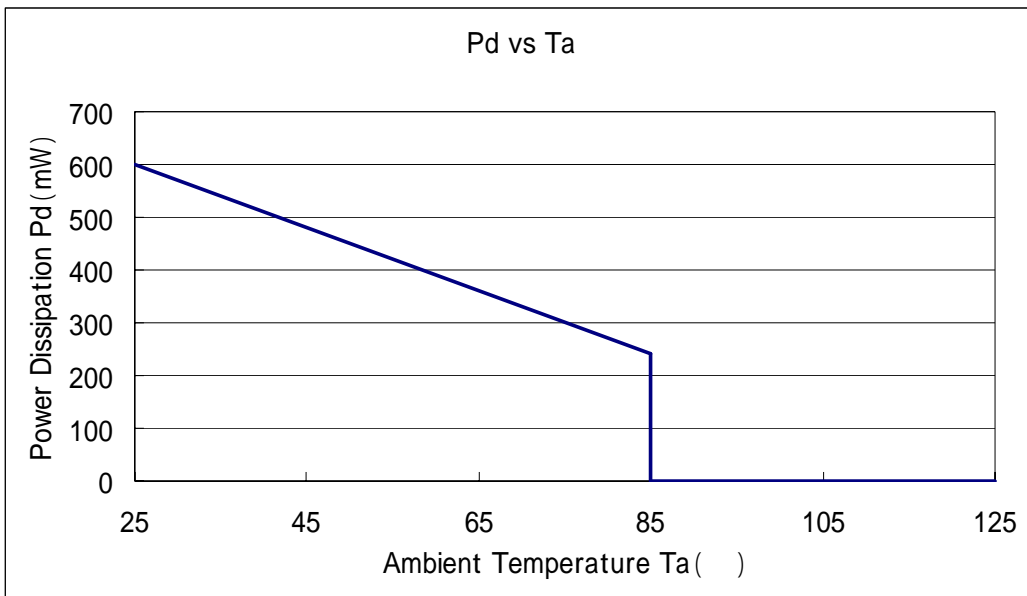

PACKAGING INFORMATION (Continued)

- SSOT-24 Power Dissipation

Power dissipation data for the SSOT-24 is shown in this page.
The value of power dissipation varies with the mount board conditions.
Please use this data as one of reference data taken in the described condition.

1. Measurement Condition (Reference data)

Condition : Mount on a board

Ambient : Natural convection

Soldering : Lead (Pb) free

Board : Dimensions 40×40mm (1600mm² in one side)

Copper (Cu) traces occupy 50% of the board area

In top and back faces

Package heat-sink is tied to the copper traces

Material : Glass Epoxy (FR-4)

Thickness : 1.6mm

Through-hole : 4 x 0.8 Diameter

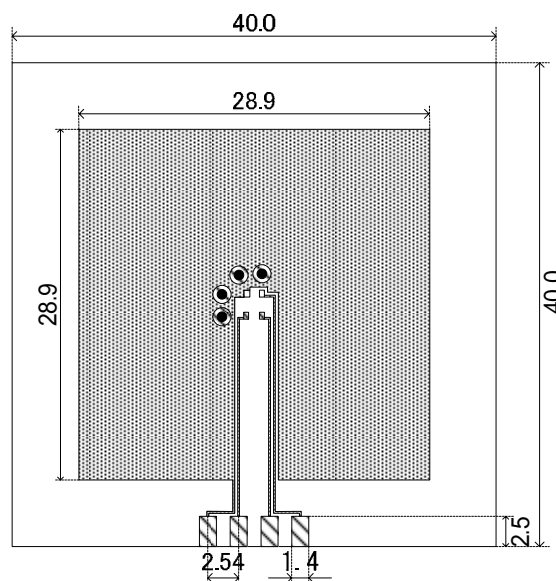

Evaluation Board (Unit: mm)

2. Power Dissipation vs. Ambient temperature

Board Mount (T_j max = 125 °C)

Ambient Temperature (°C)	Power Dissipation Pd (mW)	Thermal Resistance (°C/W)
25	500	200.00
85	200	

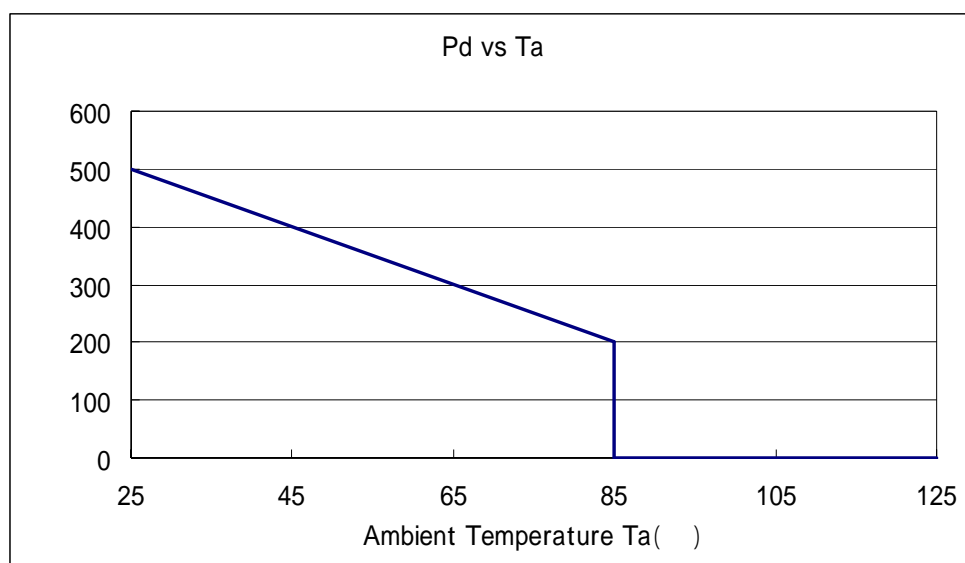

PACKAGING INFORMATION (Continued)

USPN-4 Power Dissipation

Power dissipation data for the USPN-4 is shown in this page.

The value of power dissipation varies with the mount board conditions.

Please use this data as one of reference data taken in the described condition.

1. Measurement Condition (Reference data)

- Condition: Mount on a board
- Ambient: Natural convection
- Soldering: Lead (Pb) free
- Board: Dimensions 40 x 40 mm (1600 mm² in one side)
Copper (Cu) traces occupy 50% of the front and 50% of the back.
The copper area is divided into four block, one block is 12.5% of total.
The USPN-4 package has for terminals.
Each terminal connects one copper block in the front and one in the back.
- Material: Glass Epoxy (FR-4)
- Thickness: 1.6 mm
- Through-hole: 4 x 0.8 Diameter



2. Power Dissipation vs. Ambient temperature

Board Mount (T_J max = 125 °C)

Ambient Temperature (°C)	Power Dissipation Pd (mW)	Thermal Resistance (°C/W)
25	600	166.67
85	240	



MARKING RULE

SOT-25 / USP-4



SOT-25
(TOP VIEW)



USP-4
(TOP VIEW)

represents product series

MARK	PRODUCT SERIES
3	XC6221A/B*****
0	XC6221C/D*****

represents type of regulator

MARK				PRODUCT SERIES
OUTPUT VOLTAGE 0.1V INCREMENTS		OUTPUT VOLTAGE 0.05V INCREMENTS		
$V_{OUT} = 0.80 \sim 3.00V$	$V_{OUT} = 3.10 \sim 5.00V$	$V_{OUT} = 0.85 \sim 3.05V$	$V_{OUT} = 3.15 \sim 4.95V$	
V	A	E	L	XC6221A/C*****
X	B	F	M	XC6221B/D*****

represents output voltage

MARK	OUTPUT VOLTAGE (V)				MARK	OUTPUT VOLTAGE (V)			
0	-	3.10	-	3.15	F	1.60	4.60	1.65	4.65
1	-	3.20	-	3.25	H	1.70	4.70	1.75	4.75
2	-	3.30	-	3.35	K	1.80	4.80	1.85	4.85
3	-	3.40	-	3.45	L	1.90	4.90	1.95	4.95
4	-	3.50	-	3.55	M	2.00	5.00	2.05	-
5	-	3.60	-	3.65	N	2.10	-	2.15	-
6	-	3.70	-	3.75	P	2.20	-	2.25	-
7	0.80	3.80	0.85	3.85	R	2.30	-	2.35	-
8	0.90	3.90	0.95	3.95	S	2.40	-	2.45	-
9	1.00	4.00	1.05	4.05	T	2.50	-	2.55	-
A	1.10	4.10	1.15	4.15	U	2.60	-	2.65	-
B	1.20	4.20	1.25	4.25	V	2.70	-	2.75	-
C	1.30	4.30	1.35	4.35	X	2.80	-	2.85	-
D	1.40	4.40	1.45	4.45	Y	2.90	-	2.95	-
E	1.50	4.50	1.55	4.55	Z	3.00	-	3.05	-

represents production lot number

01, ..., 09, 10, 11, ..., 99, 0A, ..., 0Z, 1A, ..., 9Z, A0, ..., Z9, AA, ..., ZZ repeated.

(G, I, J, O, Q, W excluded)

*No character inversion used.

MARKING RULE (Continued)

SSOT-24(Without bar) / USPN-4

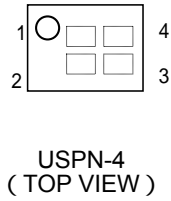
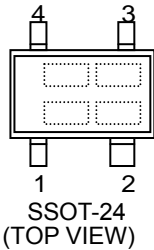

represents type of regulator and output voltage range.

MARK	TYPE OF REGULATOR	OUTPUT VOLTAGE RANGE(V)	OUTPUT VOLTAGE ACCURACY	PRODUCT SERIES
9	A	0.80 ~ 3.00	1/2(0.1VStep)	XC6221A081/2** ~ XC6221A301/2**
D	A	3.10 ~ 4.00	1/2(0.1VStep)	XC6221A311/2** ~ XC6221A401/2**
0	A	4.10 ~ 5.00	1/2(0.1VStep)	XC6221A411/2** ~ XC6221A501/2**
A	A	0.85 ~ 3.05	A/B(0.05VStep)	XC6221A08A/B** ~ XC6221A30A/B**
E	A	3.15 ~ 3.95	A/B(0.05VStep)	XC6221A31A/B** ~ XC6221A39A/B**
0	A	4.05 ~ 4.95	A/B(0.05VStep)	XC6221A40A/B** ~ XC6221A49A/B**
B	B	0.80 ~ 3.00	1/2(0.1VStep)	XC6221B081/2** ~ XC6221B301/2**
F	B	3.10 ~ 4.00	1/2(0.1VStep)	XC6221B311/2** ~ XC6221B401/2**
P	B	4.10 ~ 4.80	1/2(0.1VStep)	XC6221B411/2** ~ XC6221B481/2**
U	B	4.90 ~ 5.00	1/2(0.1VStep)	XC6221B491/2** ~ XC6221B501/2**
C	B	0.85 ~ 3.05	A/B(0.05VStep)	XC6221B31A/B** ~ XC6221B39A/B**
H	B	3.15 ~ 3.95	A/B(0.05VStep)	XC6221B40A/B** ~ XC6221B49A/B**
8	B	4.05 ~ 4.35	A/B(0.05VStep)	XC6221B31A/B** ~ XC6221B39A/B**
H	B	4.45 ~ 4.75	A/B(0.05VStep)	XC6221B40A/B** ~ XC6221B49A/B**
Z	B	4.85 ~ 4.95	A/B(0.05VStep)	XC6221B40A/B** ~ XC6221B49A/B**

* The range of the output voltage of USPN-4 package is 1.20V $V_{OUT(T)}$ 5.00V.

represents output voltage

XC6221A***** (0.8 ~ 5.0V) 、XC6221B***** (0.8 ~ 4.0V)

MARK	OUTPUT VOLTAGE (V)				MARK	OUTPUT VOLTAGE (V)			
0	-	3.10	-	3.15	F	1.60	4.60	1.65	-
1	-	3.20	-	3.25	H	1.70	4.70	1.75	-
2	-	3.30	-	3.35	K	1.80	4.80	1.85	-
3	-	3.40	-	3.45	L	1.90	4.90	1.95	-
4	-	3.50	-	3.55	M	2.00	5.00	2.05	-
5	-	3.60	-	3.65	N	2.10	-	2.15	4.05
6	-	3.70	-	3.75	P	2.20	-	2.25	4.15
7	0.80	3.80	0.85	3.85	R	2.30	-	2.35	4.25
8	0.90	3.90	0.95	3.95	S	2.40	-	2.45	4.35
9	1.00	4.00	1.05	-	T	2.50	-	2.55	4.45
A	1.10	4.10	1.15	-	U	2.60	-	2.65	4.55
B	1.20	4.20	1.25	-	V	2.70	-	2.75	4.65
C	1.30	4.30	1.35	-	X	2.80	-	2.85	4.75
D	1.40	4.40	1.45	-	Y	2.90	-	2.95	7.85
E	1.50	4.50	1.55	-	Z	3.00	-	3.05	4.95

XC6221B***** (4.05 ~ 5.0V)

MARK	OUTPUT VOLTAGE (V)			
0	4.10	-	-	-
1	4.20	-	-	-
2	4.30	-	-	-
3	4.40	-	-	-
4	4.50	-	-	-
5	4.60	-	-	-
6	4.70	-	-	-
7	4.80	-	-	-
8	-	-	-	-
9	-	4.05	4.45	-
X	4.90	4.15	4.55	4.85
Y	5.00	4.25	4.65	4.95
Z	-	4.35	4.75	-

represents production lot number

01, ..., 09, 10, 11, ..., 99, 0A, ..., 0Z, 1A, ..., 9Z, A0, ..., Z9, AA, ..., ZZ repeated.

(G, I, J, O, Q, W excluded)

*No character inversion used.

MARKING RULE (Continued)

SSOT-24(With bar) / USPN-4



represents type of regulator and output voltage range.

MARK	TYPE OF REGULATOR	OUTPUT VOLTAGE RANGE(V)	OUTPUT VOLTAGE ACCURACY	PRODUCT SERIES
0	C	0.80 ~ 3.70	1/2(0.1VStep)	XC6221C081/2** ~ XC6221C371/2**
1	C	3.80 ~ 5.00	1/2(0.1VStep)	XC6221C381/2** ~ XC6221C501/2**
2	C	0.85 ~ 3.75	A/B(0.05VStep)	XC6221C08A/B** ~ XC6221C37 A/B**
3	C	3.85 ~ 4.95	A/B(0.05VStep)	XC6221C38 A/B** ~ XC6221C50 A/B**
4	D	0.80 ~ 3.70	1/2(0.1VStep)	XC6221D081/2** ~ XC6221D371/2**
5	D	3.80 ~ 5.00	1/2(0.1VStep)	XC6221D381/2** ~ XC6221D501/2**
6	D	0.85 ~ 3.75	A/B(0.05VStep)	XC6221D08A/B** ~ XC6221D37 A/B**
7	D	3.85 ~ 4.95	A/B(0.05VStep)	XC6221D38 A/B** ~ XC6221D50 A/B**

* The range of the output voltage of USPN-4 package is 1.20V $V_{OUT(T)}$ 5.00V.

represents output voltage

MARK	OUTPUT VOLTAGE (V)				MARK	OUTPUT VOLTAGE (V)			
	0.80	3.80	0.85	3.85		2.30	-	2.35	-
0	0.80	3.80	0.85	3.85	F	2.30	-	2.35	-
1	0.90	3.90	0.95	3.95	H	2.40	-	2.45	-
2	1.00	4.00	1.05	4.05	K	2.50	-	2.55	-
3	1.10	4.10	1.15	4.15	L	2.60	-	2.65	-
4	1.20	4.20	1.25	4.25	M	2.70	-	2.75	-
5	1.30	4.30	1.35	4.35	N	2.80	-	2.85	-
6	1.40	4.40	1.45	4.45	P	2.90	-	2.95	-
7	1.50	4.50	1.55	4.55	R	3.00	-	3.05	-
8	1.60	4.60	1.65	4.65	S	3.10	-	3.15	-
9	1.70	4.70	1.75	4.75	T	3.20	-	3.25	-
A	1.80	4.80	1.85	4.85	U	3.30	-	3.35	-
B	1.90	4.90	1.95	4.95	V	3.40	-	3.45	-
C	2.00	5.00	2.05	-	X	3.50	-	3.55	-
D	2.10	-	2.15	-	Y	3.60	-	3.65	-
E	2.20	-	2.25	-	Z	3.70	-	3.75	-

represents production lot number

01, ..., 09, 10, 11, ..., 99, 0A, ..., 0Z, 1A, ..., 9Z, A0, ..., Z9, AA, ..., ZZ repeated.

(G, I, J, O, Q, W excluded)

*No character inversion used.