

700mA High Speed LDO Regulator

■ GENERAL DESCRIPTION

The XC6222 series is a highly accurate, low noise, high ripple rejection, low dropout, and low power consumption high speed voltage regulator. The series consists of a voltage reference, an error amplifier, a driver transistor, a current limiter, a thermal protection circuit, and a phase compensation circuit.

The CE function enables the entire circuit to be placed in a stand-by state by inputting a low level signal to the CE pin. In this stand-by mode, the electric charge at the output capacitor (C_L) will be discharged by the internal auto-discharge switch, and as a result the VOUT pin will quickly return to the VSS level.

Over-current protection and thermal protection circuits are integrated. The protection circuit starts to operate when either output current reaches the current limit level or junction temperature reaches the temperature limit.

■ APPLICATIONS

- USB / HDMI products
- Optical disk drive
- Magnetic disk drive
- Smart phones / Mobile phones
- Portable game consoles
- Modules (wireless, cameras, etc.)
- E-book Reader / Electronic dictionaries

■ FEATURES

Maximum Output Current	: 700mA
Dropout Voltage	: 120mV @ $I_{OUT}=300\text{mA}$ ($V_{OUT}=3.0\text{V}$)
Operating Voltage Range	: 1.7V ~ 6.0V
Output Voltage	: 0.8V~5.0V (0.05V increments)
Accuracy	: $\pm 1\%$ ($V_{OUT} > 2.0\text{V}$) $\pm 0.02\text{V}$ ($V_{OUT} \leq 2.0\text{V}$)
Low Power Consumption	: 100 μA
High Ripple Rejection	: 65dB @ 1kHz
Low ESR Capacitor	: Ceramic capacitor
Chip Enable (CE)	: Active High, C_L discharge Standby Current below 0.1 μA
Operating Ambient Temperature	: $-40^\circ\text{C} \sim +85^\circ\text{C}$
Packages	: USP-6C, SOT-25, SOT-89-5
Environmentally Friendly	: EU RoHS Compliant, Pb Free

■ TYPICAL APPLICATION CIRCUIT

SOT-25
(TOP VIEW)USP-6C
(TOP VIEW)

- * C_L : 2.2 μF or higher ($V_{OUT}=2.5 \sim 5.0\text{V}$)
 4.7 μF or higher ($V_{OUT}=2.1 \sim 2.45\text{V}$)
 6.8 μF or higher ($V_{OUT}=0.8 \sim 2.05\text{V}$)

■ TYPICAL PERFORMANCE CHARACTERISTICS

- Load Transient Response

XC6222x151

$t_r = t_f = 5 \mu\text{s}$, $V_{IN} = 2.5\text{V}$, $T_a = 25^\circ\text{C}$
 $V_{OUT} = 1.0 \rightarrow 300\text{mA}$, $C_{IN} = 1.0 \mu\text{F}$ (ceramic), $C_L = 6.8 \mu\text{F}$ (ceramic)



■ BLOCK DIAGRAMS



XC6222Aseries



XC6222Dseries

* Diodes inside the circuits are ESD protection diodes and parasitic diodes.

■ PRODUCT CLASSIFICATION

● Ordering Information

XC6222①②③④⑤⑥-⑦

DESIGNATOR	ITEM	SYMBOL	DESCRIPTION
①	Type of CE	A	without CE Pull-down resistor, without C _L discharge
		B	without CE Pull-down resistor, with C _L discharge
		C	with CE Pull-down resistor, without C _L discharge
		D (The Recommended Type)	with CE Pull-down resistor, with C _L discharge
②③	Output Voltage	08~50	e.g. 2.8V → ②=2, ③=8 Output Voltage Range : 0.8~5.0 V (0.05V increments)
④	Output Voltage Accuracy	1	Output voltage {x.x0v} (the 2 nd decimal place is "0") Accuracy±1% (V _{OUT} >2.0V), ±0.02V(V _{OUT} ≤2.0V)
		B	Output voltage {x.x5v} (the 2 nd decimal place is "5") Accuracy±1% (V _{OUT} >2.0V), ±0.02V(V _{OUT} ≤2.0V)
⑤⑥-⑦ ^(*)	Packages (Order Unit)	ER-G	USP-6C (3,000/Reel)
		MR-G	SOT-25 (3,000/Reel)
		PR-G	SOT-89-5 (1,000/Reel)

^(*) The "-G" suffix denotes Halogen and Antimony free as well as being fully EU RoHS compliant.

■ PIN CONFIGURATION



*The dissipation pad for the USP-6C package should be solder-plated in recommended mount pattern and metal masking so as to enhance mounting strength and heat release. If the pad needs to be connected to other pins, it should be connected to the V_{SS} (No. 5) pin.

■ PIN ASSIGNMENT

PIN NUMBER			PIN NAME	FUNCTIONS
USP-6C	SOT-25	SOT-89-5		
1	1	4	V _{IN}	Power Input
3	5	5	V _{OUT}	Output
2,4	4	3	NC	No connection
5	2	2	V _{SS}	Ground
6	3	1	CE	ON/OFF Control

■ ABSOLUTE MAXIMUM RATINGS

PARAMETER	SYMBOL	RATINGS	UNITS
Input Voltage	V _{IN}	-0.3~+6.5	V
Output Current	I _{OUT}	1400 (*1)	mA
Output Voltage	V _{OUT}	V _{SS} -0.3~+6.5	V
CE Input Voltage	V _{CE}	V _{SS} -0.3~+6.5	V
Power Dissipation	Pd	120	mW
		1000 (PCB mounted)(*2)	
		250	
		600 (PCB mounted)(*2)	
		500	
		1300 (PCB mounted)(*2)	
Operating Ambient Temperature	Topr	-40~+85	°C
Storage Temperature	Tstg	-55~+125	°C

*1. Please use within the range of $P_d > \{(V_{IN}-V_{OUT}) \times I_{OUT}\}$

*2. The power dissipation figure shown is PCB mounted. Please refer to page 23 to 25 for details.

ELECTRICAL CHARACTERISTICS

●XC6222 Series

Ta=25°C

PARAMETER	SYMBOL	CONDITIONS	MIN.	TYP.	MAX.	UNITS	CIRCUIT
Output Voltage	V _{OUT(E)} (*2)	V _{OUT(T)} > 2.0V V _{CE} =V _{IN} , I _{OUT} =10mA	×0.99 (*3)	V _{OUT(T)} (*4)	×1.01 (*3)	V	①
		V _{OUT} ≤ 2.0V V _{CE} =V _{IN} , I _{OUT} =10mA	-0.02 (*3)		+0.02 (*3)		
Output Current	I _{OUTMAX}	V _{CE} =V _{IN} , V _{IN} =V _{OUT(T)} +1.0V V _{OUT(T)} ≥ 1.5V	700	-	-	mA	①
		V _{CE} =V _{IN} , V _{IN} =2.5V V _{OUT(T)} < 1.5V					
Load Regulation	ΔV _{OUT}	V _{CE} =V _{IN} , 0.1mA ≤ I _{OUT} ≤ 300mA	see the Voltage Chart E-1			mV	①
Dropout Voltage (*5)	V _{dif}	I _{OUT} =300mA, V _{CE} =V _{IN}	see the Voltage Chart E-2			mV	①
Supply Current	I _{SS}	V _{IN} =V _{CE} =V _{OUT(T)} +1.0V I _{OUT} =0mA	-	100	220	μA	②
Stand-by Current	I _{STBY}	V _{IN} =6.0V, V _{CE} =V _{SS}	-	0.01	0.1	μA	②
Line Regulation	ΔV _{OUT} / (ΔV _{IN} · V _{OUT})	V _{OUT(T)} +0.5V ≤ V _{IN} ≤ 6.0V :V _{OUT(T)} ≥ 1.0V V _{CE} =V _{IN} , I _{OUT} =30mA	-	0.01	0.1	%V	①
		1.5V ≤ V _{IN} ≤ 6.0V :V _{OUT(T)} ≤ 0.95V V _{CE} =V _{IN} , I _{OUT} =30mA					
Input Voltage	V _{IN}		1.7	-	6.0	V	①
Output Voltage Temperature Characteristics	ΔV _{OUT} / (ΔTa · V _{OUT})	V _{CE} =V _{IN} , I _{OUT} =30mA -40°C ≤ Ta ≤ 85°C	-	±100	-	ppm/°C	①
Power Supply Rejection Ratio	PSRR	V _{OUT(T)} ≥ 1.0V V _{IN} ={V _{OUT(T)} +1.0}V _{DC} +0.5V _{p-pAC} V _{CE} =V _{IN} , I _{OUT} =30mA, f=1kHz	-	65	-	dB	③
		V _{OUT(T)} < 1.0V V _{IN} =2.0V _{DC} +0.5V _{p-pAC} V _{CE} =V _{IN} , I _{OUT} =30mA, f=1kHz					
Limit Current	I _{LIM}	V _{CE} =V _{IN} , V _{IN} =V _{OUT(T)} +1.0V V _{OUT(T)} ≥ 1.5V	720	950	-	mA	①
		V _{CE} =V _{IN} , V _{IN} =2.5V V _{OUT(T)} < 1.5V					
Short Current	I _{SHORT}	V _{CE} =V _{IN} Short V _{OUT} to V _{SS} level	-	55	-	mA	①
CE High Level Voltage	V _{CEH}		1.2	-	6.0	V	①
CE Low Level Voltage	V _{CEL}		-	-	0.3	V	①
CE High Level Current	I _{CEH}	V _{CE} =V _{IN} =6.0V, XC6222A/B series	-0.1	-	0.1	μA	①
		V _{CE} =V _{IN} =6.0V, XC6222C/D series	17.7	24	36.9	μA	①
CE High Level Voltage	I _{CEL}	V _{CE} =V _{SS}	-0.1	-	0.1	μA	①
Reverse Current (*6)	I _{REV}	V _{IN} =0V, V _{OUT} =V _{OUT(T)} , V _{CE} =V _{IN} or V _{SS}	-	0.01	1.5	μA	①
V _{OUT} Pin Sink Current (*7)	I _{REVS}	V _{IN} =V _{CE} =5.0V, V _{OUT} =6.0V	-	95	215	μA	①
		V _{IN} =5.0V, V _{CE} =V _{SS} , V _{OUT} =6.0V, XC6222A/C Series (*8)	-	2.8	5.3	μA	①
Thermal Shutdown Detect Temperature	T _{TSD}	Junction Temperature	-	150	-	°C	①
Thermal Shutdown Release Temperature	T _{TSR}	Junction Temperature	-	125	-	°C	①
CL Discharge Resistance (*9)	R _{DCHG}	V _{IN} =6.0V, V _{OUT} =4.0V, V _{CE} =V _{SS} XC6222B/D Series (*9)	370	530	690	Ω	①

■ ELECTRICAL CHARACTERISTICS (Continued)

NOTE:

- * 1: Unless otherwise stated, input voltage is $V_{IN}=V_{OUT(T)}+1.0V$.
- * 2: $V_{OUT(E)}$ is effective output voltage (Refer to the voltage chart E-0 and E-1)
It is defined as output voltages when an amply stabilized $V_{OUT(T)}+1.0V$ is supplied to the V_{IN} pin while maintaining a certain I_{OUT} .
- * 3: The relation between $V_{OUT(E)}$ and $V_{OUT(T)}$ is shown in the voltage chart E-0 and E-1.
- * 4: $V_{OUT(T)}$ is nominal output voltage
- * 5: $V_{dif} = \{V_{IN1}-V_{OUT1}\}$
 V_{OUT1} equals 98% of the output voltage when amply stabilized $V_{OUT(T)}+1.0V$ are supplied to the V_{IN} pin.
 V_{IN1} is the input voltage when V_{OUT1} appears at the V_{OUT} pin while input voltage is gradually decreased.
- * 6: Reverse current (I_{REV}) flows from V_{OUT} to V_{IN} .
- * 7: V_{OUT} pin sink current (I_{REVS}) flows from V_{OUT} to V_{SS} .
- * 8: For the XC6222A/C series only. In the XC6222B/D series, the current flows from the V_{OUT} pin to the V_{SS} pin via the internal switch when CE pin is low. Please do not connect another power supply to the V_{OUT} pin. Please also note when the XC6222A/C series connects external power supply to the V_{OUT} pin, please use it within the range from $V_{OUT(E)}$ (actual output voltage value) or more to 6.0V or less. When the voltage less than $V_{OUT(E)}$ is applied to the V_{OUT} pin by adding a power supply or battery, a low level signal should be input to the CE pin for chip disable in order to protect a reverse current at $V_{IN} < V_{OUT}$.
- * 9: For the XC6222B/D series only. The XC6222A/C series discharges via two resistors R1 and R2 shown in the block diagram.

OUTPUT VOLTAGE CHART

● Voltage Chart 1

SYMBOL	E-0		E-1		E-2	
NOMINAL OUTPUT VOLTAGE (V)	OUTPUT VOLTAGE (V)		LOAD REGULATION (mV)		DROPOUT VOLTAGE (mV)	
$V_{OUT(T)}$	$V_{OUT(E)}$		ΔV_{OUT}		V_{dif}	
	MIN.	MAX.	TYP.	MAX.	TYP.	MAX.
0.80	0.7800	0.8200	25	50	720	880
0.85	0.8300	0.8700	25	50	720	880
0.90	0.8800	0.9200	25	50	720	880
0.95	0.9300	0.9700	25	50	720	880
1.00	0.9800	1.0200	25	50	570	740
1.05	1.0300	1.0700	30	60	570	740
1.10	1.0800	1.1200	30	60	570	740
1.15	1.1300	1.1700	30	60	570	740
1.20	1.1800	1.2200	30	60	420	570
1.25	1.2300	1.2700	30	60	420	570
1.30	1.2800	1.3200	30	60	420	570
1.35	1.3300	1.3700	30	60	420	570
1.40	1.3800	1.4200	30	60	320	470
1.45	1.4300	1.4700	30	60	320	470
1.50	1.4800	1.5200	30	60	280	410
1.55	1.5300	1.5700	30	60	280	410
1.60	1.5800	1.6200	30	60	280	410
1.65	1.6300	1.6700	30	60	280	410
1.70	1.6800	1.7200	30	60	280	410
1.75	1.7300	1.7700	30	60	280	410
1.80	1.7800	1.8200	30	60	220	350
1.85	1.8300	1.8700	30	60	220	350
1.90	1.8800	1.9200	30	60	220	350
1.95	1.9300	1.9700	30	60	220	350
2.00	1.9800	2.0200	30	60	200	320
2.05	2.0295	2.0705	35	70	200	320
2.10	2.0790	2.1210	35	70	200	320
2.15	2.1285	2.1715	35	70	200	320
2.20	2.1780	2.2220	35	70	200	320
2.25	2.2275	2.2725	35	70	200	320
2.30	2.2770	2.3230	35	70	200	320
2.35	2.3265	2.3735	35	70	200	320
2.40	2.3760	2.4240	35	70	200	320
2.45	2.4255	2.4745	35	70	200	320
2.50	2.4750	2.5250	35	70	160	260
2.55	2.5245	2.5755	35	70	160	260
2.60	2.5740	2.6260	35	70	160	260
2.65	2.6235	2.6765	35	70	160	260
2.70	2.6730	2.7270	35	70	160	260
2.75	2.7225	2.7775	35	70	160	260
2.80	2.7720	2.8280	35	70	160	260
2.85	2.8215	2.8785	35	70	160	260
2.90	2.8710	2.9290	35	70	160	260
2.95	2.9205	2.9795	35	70	160	260

■ OUTPUT VOLTAGE CHART (Continued)

● Voltage Chart 2

SYMBOL	E-0		E-1		E-2	
NOMINAL OUTPUT VOLTAGE (V)	OUTPUT VOLTAGE (V)		LOAD REGULATION (mV)		DROPOUT VOLTAGE (mV)	
V _{OUT(T)}	V _{OUT(E)}		ΔV _{OUT}		V _{dif}	
	MIN.	MAX.	TYP.		MIN.	MAX.
3.00	2.9700	3.0300	43	85	120	200
3.05	3.0195	3.0805	43	85	120	200
3.10	3.0690	3.1310	43	85	120	200
3.15	3.1185	3.1815	43	85	120	200
3.20	3.1680	3.2320	43	85	120	200
3.25	3.2175	3.2825	43	85	120	200
3.30	3.2670	3.3330	43	85	120	200
3.35	3.3165	3.3835	43	85	120	200
3.40	3.3660	3.4340	43	85	120	200
3.45	3.4155	3.4845	43	85	120	200
3.50	3.4650	3.5350	43	85	120	200
3.55	3.5145	3.5855	43	85	120	200
3.60	3.5640	3.6360	43	85	120	200
3.65	3.6135	3.6865	43	85	120	200
3.70	3.6630	3.7370	43	85	120	200
3.75	3.7125	3.7875	43	85	120	200
3.80	3.7620	3.8380	43	85	120	200
3.85	3.8115	3.8885	43	85	120	200
3.90	3.8610	3.9390	43	85	120	200
3.95	3.9105	3.9895	43	85	120	200
4.00	3.9600	4.0400	43	85	120	200
4.05	4.0095	4.0905	50	100	120	200
4.10	4.0590	4.1410	50	100	120	200
4.15	4.1085	4.1915	50	100	120	200
4.20	4.1580	4.2420	50	100	120	200
4.25	4.2075	4.2925	50	100	120	200
4.30	4.2570	4.3430	50	100	120	200
4.35	4.3065	4.3935	50	100	120	200
4.40	4.3560	4.4440	50	100	120	200
4.45	4.4055	4.4945	50	100	120	200
4.50	4.4550	4.5450	50	100	120	200
4.55	4.5045	4.5955	50	100	120	200
4.60	4.5540	4.6460	50	100	120	200
4.65	4.6035	4.6965	50	100	120	200
4.70	4.6530	4.7470	50	100	120	200
4.75	4.7025	4.7975	50	100	120	200
4.80	4.7520	4.8480	50	100	120	200
4.85	4.8015	4.8985	50	100	120	200
4.90	4.8510	4.9490	50	100	120	200
4.95	4.9005	4.9995	50	100	120	200
5.00	4.9500	5.0500	50	100	120	200

OPERATIONAL EXPLANATION

The voltage divided by two resistors R1 and R2 is compared with the internal reference voltage by the error amplifier. The P-channel MOSFET connected to the V_{OUT} pin, is then driven by the subsequent output signal. The output voltage at the V_{OUT} pin is controlled and stabilized by a system of negative feedback. The current limit and short protection operate in relation to the level of output current. The thermal protection operates in relation to the level of heat generation. The reverse current protection operates when V_{OUT} voltage is higher than V_{IN} voltage. Further, the IC's internal circuitry can be turned off via the CE pin's signal.



<Input and Output Capacitors>

The XC6222 needs an output capacitor C_L for phase compensation. Values required for the phase compensation are shown in the chart below. If a loss of the capacitance happens, stable phase compensation may not be obtained. Please ensure to use a capacitor which does not depend on bias or temperature too much. For a stable power input, please connect an input capacitor C_{IN} of 1.0 μF between the V_{IN} pin and the V_{SS} pin.

● Output Capacitor (C_L) Table

OUTPUT VOLTAGE (V)	OUTPUT CAPACITOR VALUE
0.8V~2.05V	C _L =6.8 μF (MIN.)
2.1V~2.45V	C _L =4.7 μF (MIN.)
2.5V~5.0V	C _L =2.2 μF (MIN.)

<Reverse Current Protection>

The XC6222 series includes reverse current protection to prevent the damage to any connected products such as batteries as a result of current flow from the V_{OUT} pin to the V_{IN} pin. When V_{IN} is smaller than V_{OUT}, the reverse current protection works and suppress the reverse current to 1.5 μA (MAX.). When V_{IN} is smaller than V_{OUT}, the V_{OUT} pin sink current flows from the V_{OUT} pin to the V_{SS} pin is 95 μA (TYP.) as the IC operation current. With the XC6222A/C series, when a low level signal is inputted to the CE pin, the sink current of the V_{OUT} pin is minimized to 2.8 μA (TYP.). However, with the XC6222B/D series, when a low level signal is inputted to the CE pin, the sink current of the V_{OUT} pin goes through the C_L auto discharge circuit to the V_{SS} pin which may result in the IC being damaged. In this case, please do not connect a power supply to the V_{OUT} pin.

Please also note when the XC6222A/C series connects external power supply to the V_{OUT} pin, please use it within the range from V_{OUT(E)} (actual output voltage value) or more to 6.0V or less. When the voltage less than V_{OUT(E)} is applied to the V_{OUT} pin by adding a power supply or battery, a low level signal should be input to the CE pin for chip disable in order to protect a reverse current at V_{IN} < V_{OUT}.

Example) The voltage less than V_{OUT(E)} (actual output voltage value) is applied to the V_{OUT} pin as "OR" connection.



■ OPERATIONAL EXPLANATION (Continued)

<Current Limiter, Short-Circuit Protection>

The XC6222 series' fold-back circuit operates as an output current limiter and a short protection circuit for the output pin. When the load current reaches the current limit level, the fixed current limiter circuit operates and output voltage drops. When the output pin is short-circuited to the V_{SS} pin, the current is decreased to a level of 55mA.

<Thermal Shutdown>

When the junction temperature of the built-in driver transistor reaches the temperature limit level (150°C TYP.), the thermal shutdown circuit operates and the driver transistor will be turned OFF. The IC resumes its operation when the thermal shutdown function is released and the IC's operation is automatically restored because the junction temperature drops to the level of 125°C (TYP.) as the thermal shutdown release voltage.

<C_L Auto-Discharge Function>

XC6222B/D series can discharge the electric charge stored in the output capacitor (C_L), when a low signal to the CE pin, which enables the whole IC circuit to be turned off, is inputted via the N-channel transistor located between the V_{OUT} pin and the V_{SS} pin (cf. BLOCK DIAGRAM). The CL auto-discharge resistance value is set at 530Ω (TYP.). The discharge time of the output capacitor (C_L) is set by the CL auto-discharge resistance (R) and the output capacitor (C_L). By setting the time constant of the CL auto-discharge resistance value [R_{DCHG}] and the output capacitor value (C_L) as τ ($\tau = C \times R_{DCHG}$), the output voltage after discharge via the N-channel transistor is calculated by the following formula.

$$V = V_{OUT(E)} \times e^{-t/\tau}, \quad \text{or} \quad t = \tau \ln (V / V_{OUT(E)})$$

where

V: Output voltage after discharge

V_{OUT(E)}: Output voltage

t: Discharge time

τ : CL auto-discharge resistance R_{DCHG} × Output capacitor (C_L) value C

<CE Pin>

The entire XC6222 circuitry can be turned off via the CE pin signal. In shutdown mode, output at the V_{OUT} pin will be pulled down to the V_{SS} level via R1 & R2. However, with the XC6222B series, the CL auto-discharge resistor is connected in parallel to R1 and R2 while the power supply is applied to the V_{IN} pin. Therefore, time until the V_{OUT} pin reaches the V_{SS} level is shorter. For the XC6222A/B series, the output voltage becomes unstable, when the CE pin is left open. If this CE pin voltage is set with the specified voltage range, the logic is fixed and the IC will operate normally. However, the supply current may increase as a result of shoot-through current in the IC's internal circuitry when a medium voltage is input to the CE pin. With the XC6222C/D series, when the CE pin is left open, output voltage is fixed to V_{SS} level.

■ NOTES ON USE

1. For temporary, transitional voltage drop or voltage rising phenomenon, the IC is liable to malfunction should the ratings be exceeded.
2. Where wiring impedance is high, operations may become unstable due to noise and/or phase lag depending on output current.
Please wire the input capacitor (C_{IN}) and the output capacitor (C_L) as close to the IC as possible.
3. Torex places an importance on improving our products and their reliability.
We request that users incorporate fail-safe designs and post-aging protection treatment when using Torex products in their systems.

TEST CIRCUITS

● Circuit ①



● Circuit ②



● Circuit ③



* C_{IN} : $1.0 \mu\text{F}$ or higher
 C_L : $2.2 \mu\text{F}$ or higher ($V_{OUT}=2.5\sim 5.0\text{V}$)
 $4.7 \mu\text{F}$ or higher ($V_{OUT}=2.1\sim 2.45\text{V}$)
 $6.8 \mu\text{F}$ or higher ($V_{OUT}=0.8\sim 2.05\text{V}$)

TYPICAL PERFORMANCE CHARACTERISTICS

(1) Output Voltage vs. Output Current

*CE Voltage condition: unless otherwise stated $V_{CE}=V_{IN}$

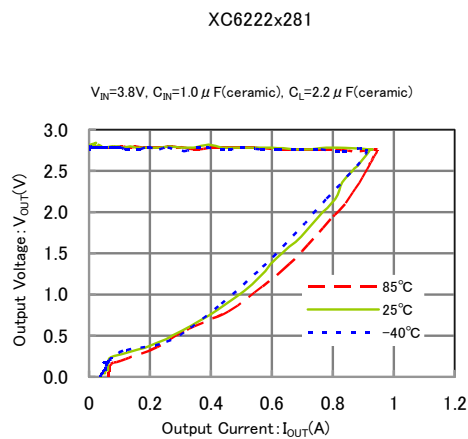

TYPICAL PERFORMANCE CHARACTERISTICS (Continued)

(1) Output Voltage vs. Output Current (Continued)



(2) Output Voltage vs. Input Current



■ TYPICAL PERFORMANCE CHARACTERISTICS (Continued)

(2) Output Voltage vs. Input Current (Continued)



(3) Dropout Voltage vs. Output Current



TYPICAL PERFORMANCE CHARACTERISTICS (Continued)

(3) Dropout Voltage vs. Output Current (Continued)



(4) Supply Current vs. Input Voltage

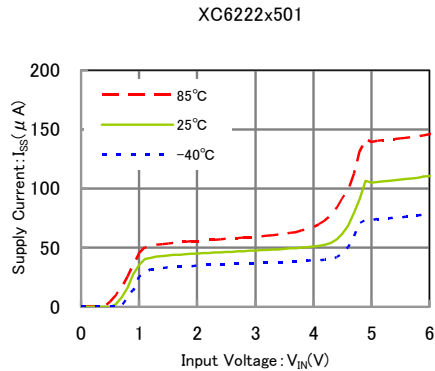
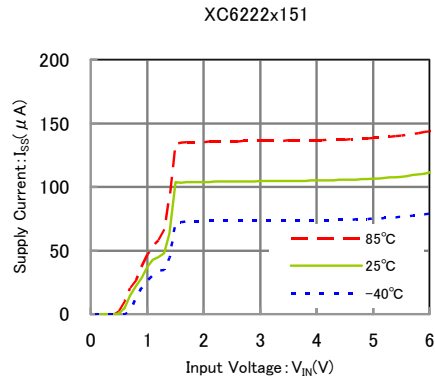

TYPICAL PERFORMANCE CHARACTERISTICS (Continued)

(5) Output Voltage vs. Ambient Temperature



(6) CE Pin Threshold Voltage vs. Ambient Temperature



(7) Reverse Current vs. Output Voltage



TYPICAL PERFORMANCE CHARACTERISTICS (Continued)

(8) V_{OUT} Sink Current vs. Output Voltage



■ TYPICAL PERFORMANCE CHARACTERISTICS (Continued)

(9) Input Transient Response 1



(10) CE Rising Response Time



TYPICAL PERFORMANCE CHARACTERISTICS (Continued)

(10) CE Rising Response Time (Continued)



(11) Input Transient Response 2



TYPICAL PERFORMANCE CHARACTERISTICS (Continued)

(12) Load Transient Response



TYPICAL PERFORMANCE CHARACTERISTICS (Continued)

(12) Load Transient Response (Continued)



(13) Ripple Rejection Rate



■ TYPICAL PERFORMANCE CHARACTERISTICS (Continued)

(14) Output Noise Density



PACKAGING INFORMATION

● SOT-25



● SOT-89-5

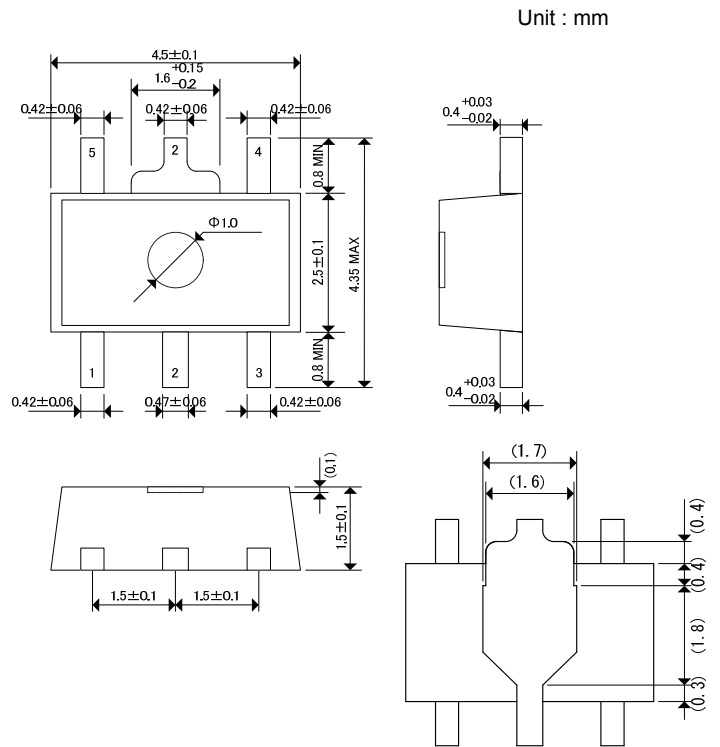

Unit : mm

● USP-6C

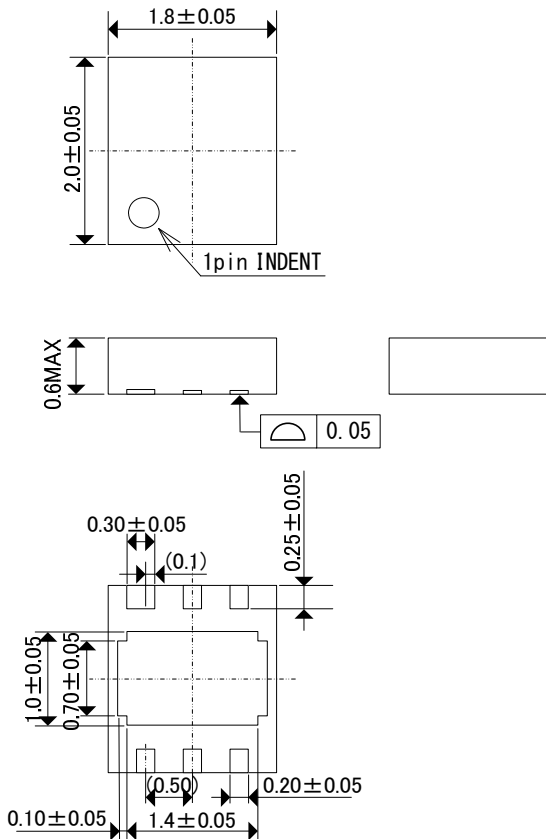

● USP-6C Reference Pattern Layout

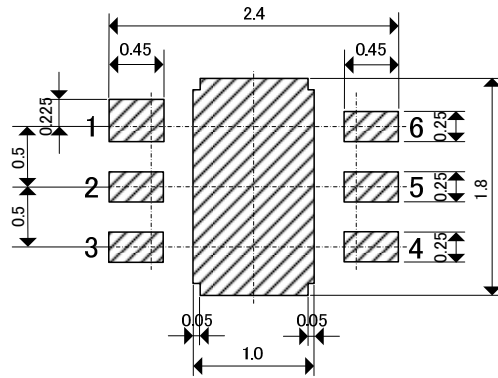

● USP-6C Reference Metal Mask Design

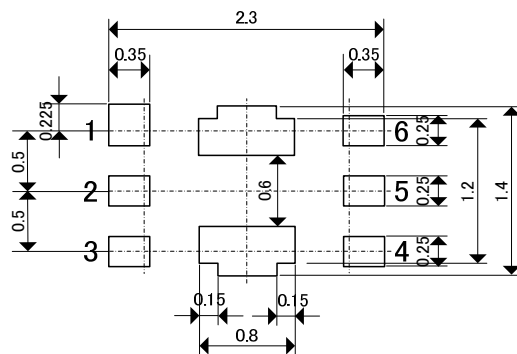

■ PACKAGING INFORMATION (Continued)

- USP-6C Power Dissipation

Power dissipation data for the USP-6C is shown in this page.

The value of power dissipation varies with the mount board conditions.

Please use this data as the reference data taken in the following condition.

1. Measurement Condition

- Condition: Mount on a board
- Ambient: Natural convection
- Soldering: Lead (Pb) free
- Board: Dimensions 40 x 40 mm (1600 mm² in one side)
Copper (Cu) traces occupy 50% of the board area
In top and back faces
Package heat-sink is tied to the copper traces

Material: Glass Epoxy (FR-4)

Thickness: 1.6 mm

Through-hole: 4 x 0.8 Diameter



Evaluation Board (Unit: mm)

2. Power Dissipation vs. Ambient Temperature

Board Mount ($T_j \text{ max} = 125^\circ\text{C}$)

Ambient Temperature ($^\circ\text{C}$)	Power Dissipation P_d (mW)	Thermal Resistance ($^\circ\text{C}/\text{W}$)
25	1000	100.00
85	400	



PACKAGING INFORMATION (Continued)

SOT-25 Power Dissipation

Power dissipation data for the SOT-25 is shown in this page.
 The value of power dissipation varies with the mount board conditions.
 Please use this data as the reference data taken in the following condition.

1. Measurement Condition

- Condition: Mount on a board
- Ambient: Natural convection
- Soldering: Lead (Pb) free
- Board: Dimensions 40 x 40 mm (1600 mm² in one side)
 Copper (Cu) traces occupy 50% of the board area
 In top and back faces
 Package heat-sink is tied to the copper traces
 (Board of SOT-26 is used.)
- Material: Glass Epoxy (FR-4)
- Thickness: 1.6 mm
- Through-hole: 4 x 0.8 Diameter



Evaluation Board (Unit: mm)

2. Power Dissipation vs. Ambient Temperature

Board Mount ($T_j \text{ max} = 125^\circ\text{C}$)

Ambient Temperature ($^\circ\text{C}$)	Power Dissipation Pd (mW)	Thermal Resistance ($^\circ\text{C}/\text{W}$)
25	600	166.67
85	240	

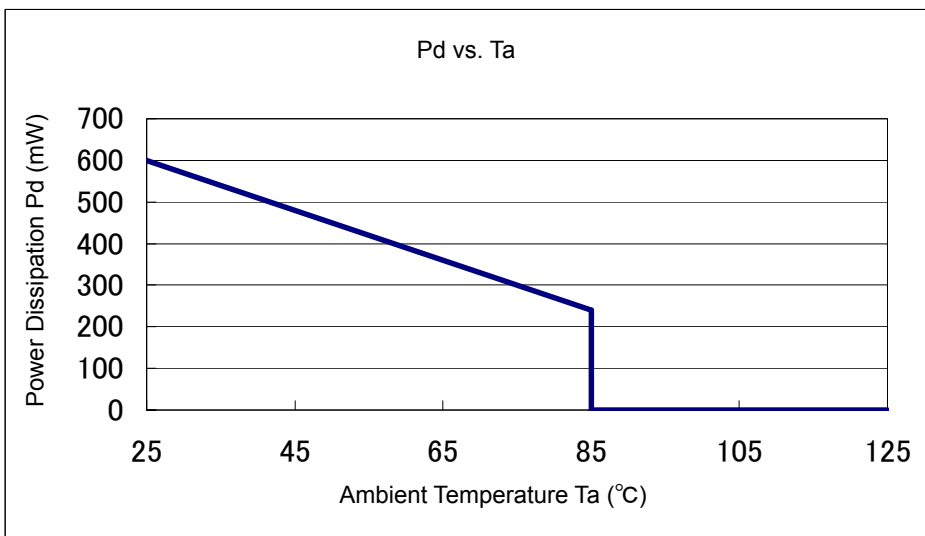

■ PACKAGING INFORMATION (Continued)

● SOT-89-5 Power Dissipation

Power dissipation data for the SOT-89-5 is shown in this page.
The value of power dissipation varies with the mount board conditions.
Please use this data as the reference data taken in the following condition.

1. Measurement Condition

- Condition: Mount on a board
- Ambient: Natural convection
- Soldering: Lead (Pb) free
- Board: Dimensions 40 x 40 mm (1600 mm² in one side)
Copper (Cu) traces occupy 50% of the board area
In top and back faces
Package heat-sink is tied to the copper traces
- Material: Glass Epoxy (FR-4)
- Thickness: 1.6 mm
- Through-hole: 5 x 0.8 Diameter



Evaluation Board (Unit: mm)

2. Power Dissipation vs. Ambient Temperature

Board Mount ($T_j \text{ max} = 125^\circ\text{C}$)

Ambient Temperature ($^\circ\text{C}$)	Power Dissipation Pd (mW)	Thermal Resistance ($^\circ\text{C}/\text{W}$)
25	1300	76.92
85	520	



MARKING RULE

① represents product series

MARK	PRODUCT SERIES
N	XC6222*****-G

② represents regulator type, voltage range, and accuracy

MARK	REGULATOR TYPE	OUTPUT VOLTAGE RANGE	ACCURACY	PRODUCT SERIES
C	A	0.8~2.9	1	XC6222A081**-G~XC6222A291**-G
D	A	0.85~2.95	B	XC6222A08B**-G~XC6222A29B**-G
E	A	3.0~5.0	1	XC6222A301**-G~XC6222A501**-G
F	A	3.05~4.95	B	XC6222A30B**-G~XC6222A49B**-G
H	B	0.8~2.9	1	XC6222B081**-G~XC6222B291**-G
K	B	0.85~2.95	B	XC6222B08B**-G~XC6222B29B**-G
L	B	3.0~5.0	1	XC6222B301**-G~XC6222B501**-G
M	B	3.05~4.95	B	XC6222B30B**-G~XC6222B49B**-G
N	C	0.8~2.9	1	XC6222C081**-G~XC6222C291**-G
P	C	0.85~2.95	B	XC6222C08B**-G~XC6222C29B**-G
R	C	3.0~5.0	1	XC6222C301**-G~XC6222C501**-G
S	C	3.05~4.95	B	XC6222C30B**-G~XC6222C49B**-G
T	D	0.8~2.9	1	XC6222D081**-G~XC6222D291**-G
U	D	0.85~2.95	B	XC6222D08B**-G~XC6222D29B**-G
V	D	3.0~5.0	1	XC6222D301**-G~XC6222D501**-G
X	D	3.05~4.95	B	XC6222D30B**-G~XC6222D49B**-G

* Accuracy "1": 0.1V increments. Accuracy "B": 0.05V increments

③ represents output voltage

MARK	OUTPUT VOLTAGE		MARK	OUTPUT VOLTAGE		MARK	OUTPUT VOLTAGE	
0	-	3.0x	A	1.0x	4.0x	N	2.0x	5.0x
1	-	3.1x	B	1.1x	4.1x	P	2.1x	-
2	-	3.2x	C	1.2x	4.2x	R	2.2x	-
3	-	3.3x	D	1.3x	4.3x	S	2.3x	-
4	-	3.4x	E	1.4x	4.4x	T	2.4x	-
5	-	3.5x	F	1.5x	4.5x	U	2.5x	-
6	-	3.6x	F	1.6x	4.6x	V	2.6x	-
7	-	3.7x	K	1.7x	4.7x	X	2.7x	-
8	0.8x	3.8x	L	1.8x	4.8x	Y	2.8x	-
9	0.9x	3.9x	M	1.9x	4.9x	Z	2.9x	-

④⑤ represents production lot number

01 to 09, 0A to 0Z, 11 to 9Z, A1 to A9, AA to Z9, ZA to ZZ in order.
(G, I, J, O, Q, W excluded. No character inversion used.)

● SOT-25



SOT89-5



USP6C

