

## 700mA High Speed LDO Regulator with Reverse Current Protection

## ■ GENERAL DESCRIPTION

The XC6227 series is a highly accurate, low noise, high ripple rejection, low dropout, and low power consumption high speed voltage regulator.

The series consists of a voltage reference, an error amplifier, a driver transistor, a current limiter, a thermal protection circuit, a reverse current protection circuit and a phase compensation circuit.

The CE function enables the entire circuit to be placed in a stand-by state by inputting a low level signal to the CE pin. Over-current protection and thermal protection circuits are integrated. The protection circuit starts to operate when either output current reaches the current limit level or junction temperature reaches the temperature limit. With the reverse current protection function of a driver transistor, the reverse current flow is prohibited when  $V_{OUT}$  voltage is higher than  $V_{IN}$  voltage. For an example, when a battery is connected to the  $V_{OUT}$  pin, battery current will not flow back to the XC6227.

## ■ APPLICATIONS

- USB products and HDMI equipments
- E-book Readers / Electronic dictionaries
- Smart Phones / Mobile phones
- Portable game consoles
- Modules (Wireless, Camera, etc.)

## ■ FEATURES

<b>Maximum Output Current</b>	: 700mA
<b>Dropout Voltage</b>	: 120mV @ $I_{OUT}=300mA$ ( $V_{OUT}=3.0V$ )
<b>Operating Voltage Range</b>	: 1.7V ~ 6.0V
<b>Output Voltages</b>	: 0.8V ~ 5.0V (0.05V increments)
<b>Accuracy</b>	: $\pm 1\%$ ( $V_{OUT} > 2.0V$ ) $\pm 0.02V$ ( $V_{OUT} \leq 2.0V$ )
<b>Low Power Consumption</b>	: 100 $\mu$ A
<b>Chip Enable(CE)</b>	: Active High Standby Current below 0.1 $\mu$ A
<b>High Ripple Rejection</b>	: 65dB @ 1kHz
<b>Operating Ambient Temperature</b>	: $-40^{\circ}C$ ~ $85^{\circ}C$
<b>Low ESR Capacitor</b>	: Ceramic capacitor
<b>Packages</b>	: USP-6C, SOT-25, SOT-89-5
<b>Environmentally Friendly</b>	: EU RoHS Compliant, Pb Free

## ■ TYPICAL APPLICATION CIRCUIT ■ TYPICAL PERFORMANCE CHARACTERISTICS

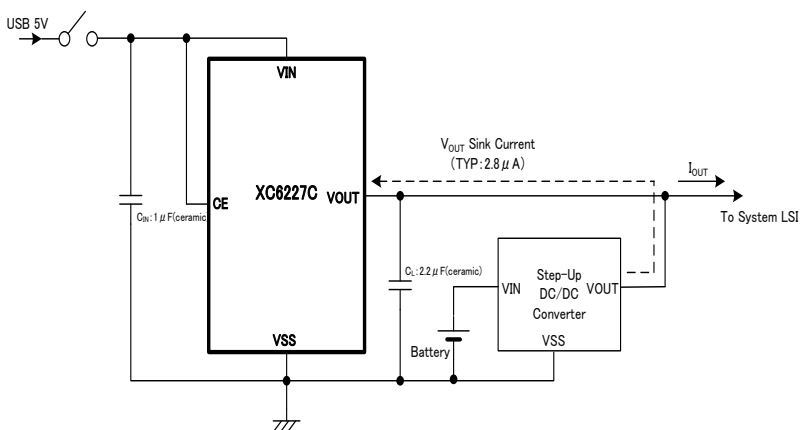
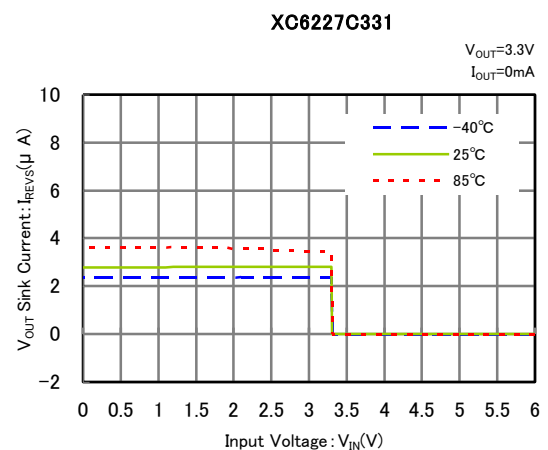
●  $V_{OUT}$  Sink Current VS. Input Voltage

## ■ BLOCK DIAGRAM

1) XC6227 series A type

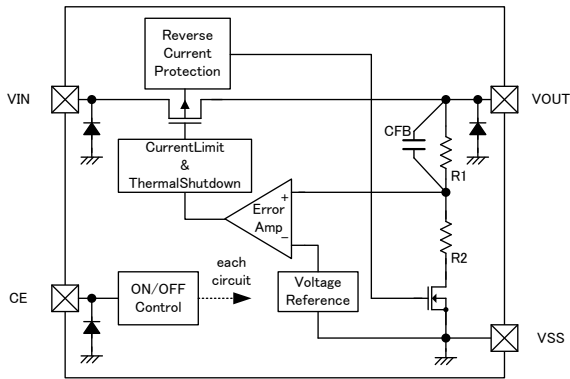

2) XC6227series C type

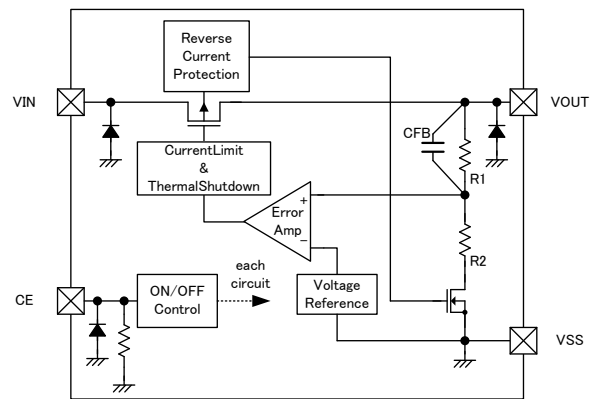

\* Diodes inside the circuits are ESD protection diodes and parasitic diodes.

## ■ PRODUCT CLASSIFICATION

### ● Ordering Information

XC6227①②③④⑤⑥-⑦<sup>(\*)</sup>

DESIGNATOR	ITEM	SYMBOL	DESCRIPTION
①	Type	A	Refer to Selection Guide
		C	
②③	Output Voltage	08 ~ 50	e.g. 2.8V → ②=2, ③=8
④	Output Voltage (the 2 <sup>nd</sup> decimal place)	1	Output voltage {x.x0v} (the 2nd decimal place is "0") ±1% ( $V_{OUT} > 2.0V$ ), ±20mV ( $V_{OUT} \leq 2.0V$ )
		B	Output voltage {x.x5v} (the 2nd decimal place is "5") ±1% ( $V_{OUT(T)} > 2.0V$ ), ±20mV ( $V_{OUT(T)} \leq 2.0V$ )
⑤⑥-⑦	Packages (Order Unit)	MR-G	SOT-25 (3,000pcs/Reel)
		PR-G	SOT-89-5 (1,000pcs/Reel)
		ER-G	USP-6C (3,000pcs/Reel)

<sup>(\*)</sup> The "-G" suffix denotes Halogen and Antimony free as well as being fully EU RoHS compliant.

### ● Selection Guide

TYPE	CE High Active	CE PULL-DOWN RESISTOR
A	Yes	No
C	Yes	Yes

## ■ PIN CONFIGURATION

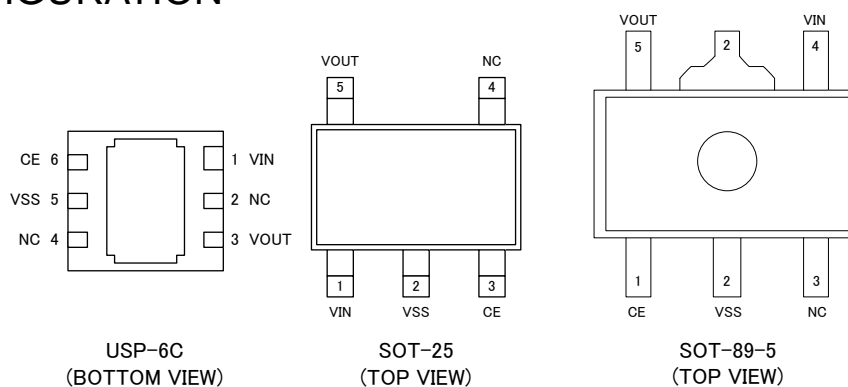

\*The dissipation pad for the USP-6C package should be solder-plated in recommended mount pattern and metal masking so as to enhance mounting strength and heat release. If the pad needs to be connected to other pins, it should be connected to the VSS (No. 5) pin.

PIN NUMBER			PIN NAME	FUNCTIONS
USP-6C	SOT-25	SOT-89-5		
1	1	4	$V_{IN}$	Power Input
3	5	5	$V_{OUT}$	Output
2,4	4	3	NC	No connection
5	2	2	$V_{SS}$	Ground
6	3	1	CE	ON/OFF Control

## ■ FUNCTION CHART

PIN NAME	SIGNAL	TYPE	STATUS
CE	L	A,C	Stand-by
	H	A,C	Active
	OPEN	A	Undefined state
		C	Stand-by

## ■ ABSOLUTE MAXIMUM RATINGS

PARAMETER		SYMBOL	RATINGS	UNITS
Input Voltage		$V_{IN}$	$V_{SS} - 0.3 \sim 6.5$	V
Output Voltage		$V_{OUT}$	$V_{SS} - 0.3 \sim 6.5$	V
CE Input Voltage		$V_{CE}$	$V_{SS} - 0.3 \sim 6.5$	V
Power Dissipation ( $T_a=25^\circ\text{C}$ )	USP-6C	Pd	120	mW
			1000 (40mm x 40mm Standard Board) <sup>(*)</sup>	
			1250(JESD51-7 Board) <sup>(*)</sup>	
	SOT-25		250	
			600 (40mm x 40mm Standard Board) <sup>(*)</sup>	
			760 (JESD51-7 Board) <sup>(*)</sup>	
	SOT-89-5		500	
			1300 (40mm x 40mm Standard Board) <sup>(*)</sup>	
Operating Ambient Temperature		$T_{opr}$	-40 ~ 85	$^\circ\text{C}$
Storage Temperature		$T_{stg}$	-55 ~ 125	$^\circ\text{C}$

<sup>(\*)</sup> The power dissipation figure shown is PCB mounted and is for reference only.  
The mounting condition is please refer to PACKAGING INFORMATION.

## ELECTRICAL CHARACTERISTICS

●XC6227 Series

Ta=25°C

PARAMETER	SYMBOL	CONDITIONS	MIN.	TYP.	MAX.	UNITS	CIRCUIT
Output Voltage	V <sub>OUT(E)</sub> (*2)	V <sub>OUT(T)</sub> > 2.0V, V <sub>CE</sub> =V <sub>IN</sub> , I <sub>OUT</sub> =10mA	×0.99 <sup>(*3)</sup>	V <sub>OUT(T)</sub> (*4)	×1.01 <sup>(*3)</sup>	V	①
		V <sub>OUT(T)</sub> ≤ 2.0V, V <sub>CE</sub> =V <sub>IN</sub> , I <sub>OUT</sub> =10mA	-0.02 <sup>(*3)</sup>		+0.02 <sup>(*3)</sup>		
Output Current	I <sub>OUTMAX</sub>	V <sub>CE</sub> =V <sub>IN</sub> , V <sub>IN</sub> =V <sub>OUT(T)</sub> +1.0V V <sub>OUT(T)</sub> > 1.5V	700	-	-	mA	①
		V <sub>CE</sub> =V <sub>IN</sub> , V <sub>IN</sub> =2.5V V <sub>OUT(T)</sub> ≤ 1.5V					
Load Regulation	ΔV <sub>OUT</sub>	V <sub>CE</sub> =V <sub>IN</sub> , 0.1mA ≤ I <sub>OUT</sub> ≤ 300mA	E-1			mV	①
Dropout Voltage1 (*5)	V <sub>dif</sub>	I <sub>OUT</sub> =300mA, V <sub>CE</sub> =V <sub>IN</sub>	E-2			mV	①
Dropout Voltage2 (*5)	V <sub>dif2</sub>	I <sub>OUT</sub> =0mA, V <sub>CE</sub> =V <sub>IN</sub>	E-3			mV	①
Supply Current	I <sub>SS</sub>	V <sub>IN</sub> =V <sub>CE</sub> =V <sub>OUT(T)</sub> +1.0V, I <sub>OUT</sub> =0mA	-	100	220	μA	②
Stand-by Current	I <sub>STBY</sub>	V <sub>IN</sub> =6.0V, V <sub>CE</sub> =V <sub>SS</sub>	-	0.01	0.1	μA	②
Line Regulation	ΔV <sub>OUT</sub> / (ΔV <sub>IN</sub> · V <sub>OUT</sub> )	V <sub>OUT(T)</sub> +0.5V ≤ V <sub>IN</sub> ≤ 6.0V :V <sub>OUT(T)</sub> ≥ 1.0V V <sub>CE</sub> =V <sub>IN</sub> , I <sub>OUT</sub> =30mA	-	0.01	0.1	%V	①
		1.5V ≤ V <sub>IN</sub> ≤ 6.0V :V <sub>OUT(T)</sub> ≤ 0.95V V <sub>CE</sub> =V <sub>IN</sub> , I <sub>OUT</sub> =30mA					
Input Voltage	V <sub>IN</sub>		1.7	-	6.0	V	①
Output Voltage Temperature Characteristics	ΔV <sub>OUT</sub> / (ΔTa · V <sub>OUT</sub> )	V <sub>CE</sub> =V <sub>IN</sub> , I <sub>OUT</sub> =30mA -40°C ≤ Ta ≤ 85°C	-	±100	-	ppm/°C	①
Power Supply Rejection Ratio	PSRR	V <sub>OUT(T)</sub> ≥ 4.8V, V <sub>IN</sub> =5.75V <sub>DC</sub> +0.5V <sub>p-pAC</sub> V <sub>CE</sub> =V <sub>IN</sub> , I <sub>OUT</sub> =30mA, f=1kHz	-	65	-	dB	③
		1.0V ≤ V <sub>OUT(T)</sub> < 4.8V V <sub>IN</sub> ={V <sub>OUT(T)</sub> +1.0}V <sub>DC</sub> +0.5V <sub>p-pAC</sub> V <sub>CE</sub> =V <sub>IN</sub> , I <sub>OUT</sub> =30mA, f=1kHz					
		V <sub>OUT(T)</sub> < 1.0V, V <sub>IN</sub> =2.0V <sub>DC</sub> +0.5V <sub>p-pAC</sub> V <sub>CE</sub> =V <sub>IN</sub> , I <sub>OUT</sub> =30mA, f=1kHz					
Limit Current	I <sub>lim</sub>	V <sub>CE</sub> =V <sub>IN</sub> , V <sub>IN</sub> =V <sub>OUT(T)</sub> +1.0V V <sub>OUT(T)</sub> > 1.5V	720	950	-	mA	①
		V <sub>CE</sub> =V <sub>IN</sub> , V <sub>IN</sub> =2.5V V <sub>OUT(T)</sub> ≤ 1.5V					
Short Current	I <sub>short</sub>	V <sub>CE</sub> =V <sub>IN</sub> , Short V <sub>OUT</sub> to V <sub>SS</sub> level	-	55	-	mA	①
CE High Level Voltage	V <sub>CEH</sub>		1.2	-	6.0	V	①
CE Low Level Voltage	V <sub>CEL</sub>		V <sub>SS</sub>	-	0.3	V	①
CE High Level Current	I <sub>CEH</sub>	V <sub>CE</sub> =V <sub>IN</sub> =6.0V, XC6227C Series	17.7	24	36.9	μA	①
CE Low Level Current	I <sub>CEL</sub>	V <sub>CE</sub> =V <sub>SS</sub>	-0.1	-	0.1	μA	①
Reverse Current (*8)	I <sub>REV</sub>	V <sub>IN</sub> =0V, V <sub>OUT</sub> =6.0V (*10)	-	0.01	1.5	μA	①
V <sub>OUT</sub> Pin Sink Current (*9)	I <sub>REVS</sub>	V <sub>IN</sub> =5.0V, V <sub>OUT</sub> =6.0V (*10)	-	2.8	5.3	μA	①
Thermal Shutdown Detect Temperature	T <sub>TSD</sub>	Junction Temperature	-	150	-	°C	①
Thermal Shutdown Release Temperature	T <sub>TSR</sub>	Junction Temperature	-	125	-	°C	①

**NOTE:**

- \* 1: Unless otherwise stated, input voltage is V<sub>IN</sub>=V<sub>OUT(T)</sub>+1.0V.
- \* 2: V<sub>OUT(E)</sub> is effective output voltage (Refer to the voltage chart E-1 and E-2)  
It is defined as output voltages when an amply stabilized V<sub>OUT(T)</sub>+1.0V is supplied to the V<sub>IN</sub> pin while maintaining a certain I<sub>OUT</sub>.
- \* 3: The relation between V<sub>OUT(E)</sub> and V<sub>OUT(T)</sub> is shown in the voltage chart E-1 and E-2.
- \* 4: V<sub>OUT(T)</sub> is nominal output voltage
- \* 5: V<sub>dif</sub> (V<sub>dif2</sub>)= {V<sub>IN1</sub><sup>(\*7)</sup>-V<sub>OUT1</sub><sup>(\*6)</sup>}
- \* 6: V<sub>OUT1</sub> equals 98% of the output voltage when amply stabilized V<sub>OUT(T)</sub>+1.0V are supplied to the V<sub>IN</sub> pin.
- \* 7: V<sub>IN1</sub> is the input voltage when V<sub>OUT1</sub> appears at the V<sub>OUT</sub> pin while input voltage is gradually decreased.
- \* 8: Reverse current (I<sub>REV</sub>) flows from V<sub>OUT</sub> to V<sub>IN</sub>.
- \* 9: V<sub>OUT</sub> pin sink current (I<sub>REVS</sub>) flows from V<sub>OUT</sub> to V<sub>SS</sub>.
- \*10: Please note when an external power supply connects to the V<sub>OUT</sub> pin, please use it with 6.0V or less.

## OUTPUT VOLTAGE CHART

● Voltage Chart 1

NOMINAL OUTPUT VOLTAGE  $V_{OUT(T)}$ (V)	OUTPUT VOLTAGE		LOAD REGULATION E-1		DROPOUT VOLTAGE 1 E-1		DROPOUT VOLTAGE 2 E-3	
	$V_{OUT(E)}$ (V)		$\Delta V_{OUT}$ (mV)		$V_{dif}$ (mV)		$V_{dif2}$ (mV)	
	MIN.	MAX.	TYP.	MAX.	TYP.	MAX.	TYP.	MAX.
0.80	0.7800	0.8200	25	50	720	880	230	510
0.85	0.8300	0.8700	25	50	720	880	230	510
0.90	0.8800	0.9200	25	50	720	880	230	510
0.95	0.9300	0.9700	25	50	720	880	230	510
1.00	0.9800	1.0200	25	50	570	740	75	260
1.05	1.0300	1.0700	30	60	570	740	75	260
1.10	1.0800	1.1200	30	60	570	740	75	260
1.15	1.1300	1.1700	30	60	570	740	75	260
1.20	1.1800	1.2200	30	60	420	570	50	135
1.25	1.2300	1.2700	30	60	420	570	40	80
1.30	1.2800	1.3200	30	60	420	570	40	80
1.35	1.3300	1.3700	30	60	420	570	40	80
1.40	1.3800	1.4200	30	60	320	470	40	80
1.45	1.4300	1.4700	30	60	320	470	40	80
1.50	1.4800	1.5200	30	60	280	410	40	80
1.55	1.5300	1.5700	30	60	280	410	40	80
1.60	1.5800	1.6200	30	60	280	410	40	80
1.65	1.6300	1.6700	30	60	280	410	40	80
1.70	1.6800	1.7200	30	60	280	410	40	80
1.75	1.7300	1.7700	30	60	280	410	40	80
1.80	1.7800	1.8200	30	60	220	350	40	80
1.85	1.8300	1.8700	30	60	220	350	40	80
1.90	1.8800	1.9200	30	60	220	350	40	80
1.95	1.9300	1.9700	30	60	220	350	40	80
2.00	1.9800	2.0200	30	60	200	320	40	80
2.05	2.0295	2.0705	35	70	200	320	40	80
2.10	2.0790	2.1210	35	70	200	320	40	80
2.15	2.1285	2.1715	35	70	200	320	40	80
2.20	2.1780	2.2220	35	70	200	320	40	80
2.25	2.2275	2.2725	35	70	200	320	40	80
2.30	2.2770	2.3230	35	70	200	320	40	80
2.35	2.3265	2.3735	35	70	200	320	40	80
2.40	2.3760	2.4240	35	70	200	320	40	80
2.45	2.4255	2.4745	35	70	200	320	40	80
2.50	2.4750	2.5250	35	70	160	260	40	80
2.55	2.5245	2.5755	35	70	160	260	40	80
2.60	2.5740	2.6260	35	70	160	260	40	80
2.65	2.6235	2.6765	35	70	160	260	40	80
2.70	2.6730	2.7270	35	70	160	260	40	80
2.75	2.7225	2.7775	35	70	160	260	40	80
2.80	2.7720	2.8280	35	70	160	260	40	80
2.85	2.8215	2.8785	35	70	160	260	40	80
2.90	2.8710	2.9290	35	70	160	260	40	80
2.95	2.9205	2.9795	35	70	160	260	40	80
3.00	2.9700	3.0300	43	85	120	200	40	80

## ■ OUTPUT VOLTAGE CHART (Continued)

● Voltage Chart 2

NOMINAL OUTPUT VOLTAGE  $V_{OUT(T)}$ (V)	OUTPUT VOLTAGE		LOAD REGULATION E-1		DROPOUT VOLTAGE 1 E-2		DROPOUT VOLTAGE 2 E-3	
	$V_{OUT(E)}$ (V)		$\Delta V_{OUT}(V)$		$V_{dif}(mV)$		$V_{dif2}(mV)$	
	MIN.	MAX.	TYP.	MAX.	TYP.	MAX.	TYP.	MAX.
3.05	3.0195	3.0805	43	85	120	200	40	80
3.10	3.0690	3.1310	43	85	120	200	40	80
3.15	3.1185	3.1815	43	85	120	200	40	80
3.20	3.1680	3.2320	43	85	120	200	40	80
3.25	3.2175	3.2825	43	85	120	200	40	80
3.30	3.2670	3.3330	43	85	120	200	40	80
3.35	3.3165	3.3835	43	85	120	200	40	80
3.40	3.3660	3.4340	43	85	120	200	40	80
3.45	3.4155	3.4845	43	85	120	200	40	80
3.50	3.4650	3.5350	43	85	120	200	40	80
3.55	3.5145	3.5855	43	85	120	200	40	80
3.60	3.5640	3.6360	43	85	120	200	40	80
3.65	3.6135	3.6865	43	85	120	200	40	80
3.70	3.6630	3.7370	43	85	120	200	40	80
3.75	3.7125	3.7875	43	85	120	200	40	80
3.80	3.7620	3.8380	43	85	120	200	40	80
3.85	3.8115	3.8885	43	85	120	200	40	80
3.90	3.8610	3.9390	43	85	120	200	40	80
3.95	3.9105	3.9895	43	85	120	200	40	80
4.00	3.9600	4.0400	43	85	120	200	40	80
4.05	4.0095	4.0905	50	100	120	200	40	80
4.10	4.0590	4.1410	50	100	120	200	40	80
4.15	4.1085	4.1915	50	100	120	200	40	80
4.20	4.1580	4.2420	50	100	120	200	40	80
4.25	4.2075	4.2925	50	100	120	200	40	80
4.30	4.2570	4.3430	50	100	120	200	40	80
4.35	4.3065	4.3935	50	100	120	200	40	80
4.40	4.3560	4.4440	50	100	120	200	40	80
4.45	4.4055	4.4945	50	100	120	200	40	80
4.50	4.4550	4.5450	50	100	120	200	40	80
4.55	4.5045	4.5955	50	100	120	200	40	80
4.60	4.5540	4.6460	50	100	120	200	40	80
4.65	4.6035	4.6965	50	100	120	200	40	80
4.70	4.6530	4.7470	50	100	120	200	40	80
4.75	4.7025	4.7975	50	100	120	200	40	80
4.80	4.7520	4.8480	50	100	120	200	40	80
4.85	4.8015	4.8985	50	100	120	200	40	80
4.90	4.8510	4.9490	50	100	120	200	40	80
4.95	4.9005	4.9995	50	100	120	200	40	80
5.00	4.9500	5.0500	50	100	120	200	40	80

## TEST CIRCUITS

Circuit ①

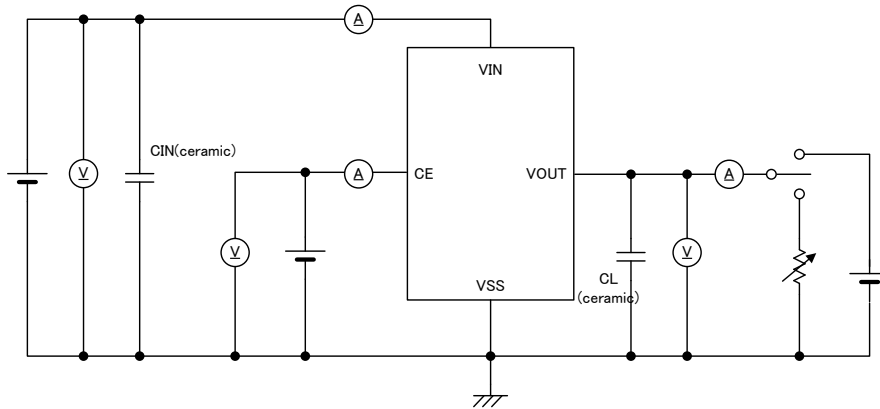

Circuit ②

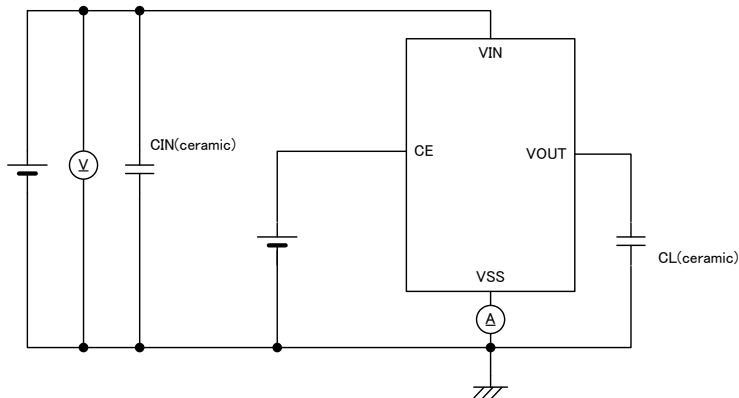

Circuit ③

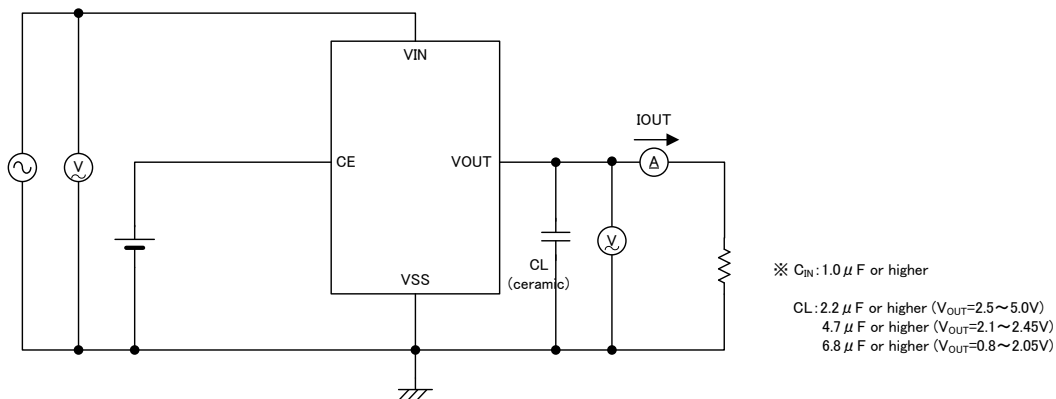



## ■ OPERATIONAL EXPLANATION

The voltage divided by two resistors R1 and R2 is compared with the internal reference voltage by the error amplifier. The P-channel MOSFET connected to the V<sub>OUT</sub> pin, is then driven by the subsequent output signal. The output voltage at the V<sub>OUT</sub> pin is controlled and stabilized by a system of negative feedback. The current limit and short protection operate in relation to the level of output current. The thermal protection operates in relation to the level of heat generation. The reverse current protection operates when V<sub>OUT</sub> voltage is higher than V<sub>IN</sub> voltage. Further, the IC's internal circuitry can be turned off via the CE pin's signal.

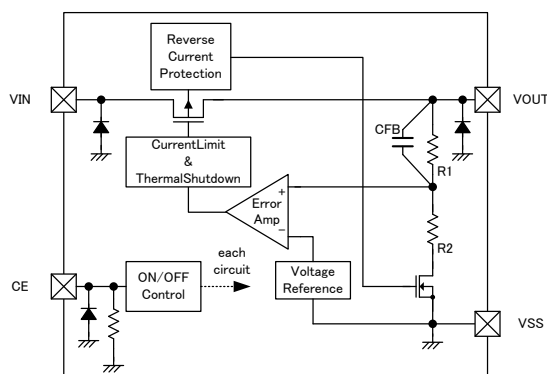

XC6227Cseries

### <Input and Output Capacitors>

The XC6227 needs an output capacitor C<sub>L</sub> for phase compensation. Values required for the phase compensation are shown in the chart below. If a loss of the capacitance happens, stable phase compensation may not be obtained. Please ensure to use a capacitor which does not depend on bias or temperature too much. For a stable power input, please connect an input capacitor C<sub>IN</sub> of 1.0μF between the V<sub>IN</sub> pin and the V<sub>SS</sub> pin.

#### ● Output Capacitor (C<sub>L</sub>) Table

NOMINAL OUTPUT VOLTAGE V <sub>OUT(T)</sub>	OUTPUT CAPACITOR C <sub>L</sub>
0.8V ~ 2.05V	C <sub>L</sub> =6.8μF
2.1V ~ 2.45V	C <sub>L</sub> =4.7μF
2.5V ~ 5.00V	C <sub>L</sub> =2.2μF

### <Reverse Current Protection>

The XC6227 series includes reverse current protection to prevent the damage as a result of current flow from V<sub>OUT</sub> pin to the V<sub>IN</sub> pin and V<sub>SS</sub> pin when the power supply is connected to the V<sub>OUT</sub> pin. When V<sub>IN</sub> is smaller than V<sub>OUT</sub>, the reverse current protection works and suppress the reverse current to 1.5μA (MAX.).

When V<sub>IN</sub> is smaller than V<sub>OUT</sub>, the V<sub>OUT</sub> pin sink current flowing from the V<sub>OUT</sub> pin to the V<sub>SS</sub> pin is 2.8μA (TYP.) as the IC operation current.

Please also note when an external power supply is connected to the V<sub>OUT</sub> pin, please use it within 6.0V.

### <Current Limiter, Short-Circuit Protection>

The XC6227 series integrates an output current limiter and a fold-back short protection for the output pin. When the load current reaches the current limit level, the fixed current limiter circuit operates and output voltage drops. When the output pin is short-circuited to the V<sub>SS</sub> pin, the current is decreased to a level of 55mA (TYP.).

### <Thermal Shutdown>

When the junction temperature of the built-in driver transistor reaches the temperature limit level (150°C TYP.), the thermal shutdown circuit operates and the driver transistor will be turned OFF. The IC resumes its operation when the thermal shutdown function is released and the IC's operation is automatically restored because the junction temperature drops to the level of 125°C (TYP.) as the thermal shutdown release voltage.

### <CE Pin>

The entire XC6227 circuitry can be turned off via the CE pin signal. In shutdown mode, output at the V<sub>OUT</sub> pin will be pulled down to the V<sub>SS</sub> level via R1 & R2.

The XC6227C type has a pull-down resistor in order to operate normally even the CE pin is left open (when the CE pin is left open, the IC stops operation), so that the CE pin input current flows.

If the CE pin voltage is set with the specified voltage range, the logic is fixed and the IC will operate normally. However, the supply current may increase as a result of shoot-through current in the IC's internal circuitry when a medium voltage is input to the CE pin.

## ■ NOTES ON USE

1. For temporary, transitional voltage drop or voltage rising phenomenon, the IC is liable to malfunction should the ratings be exceeded.
2. Where wiring impedance is high, operations may become unstable due to noise and/or phase lag depending on output current.  
Please wire the input capacitor ( $C_{IN}$ ) and the output capacitor ( $C_L$ ) as close to the IC as possible.
3. Torex places an importance on improving our products and its reliability.  
However, by any possibility, we would request user fail-safe design and post-aging treatment on system or equipment.

# TYPICAL PERFORMANCE CHARACTERISTICS

(1) Output Voltage vs. Output Current

\*CE Voltage condition: unless otherwise stated  $V_{CE}=V_{IN}$

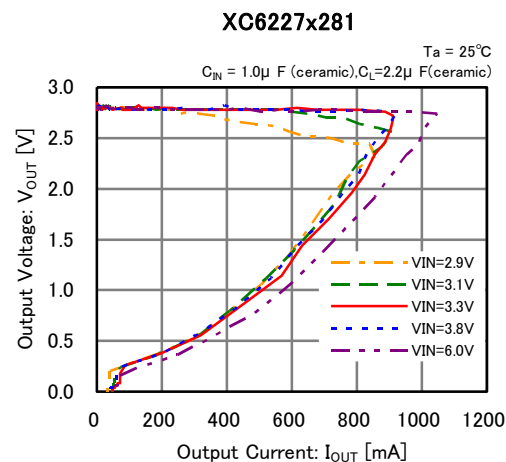
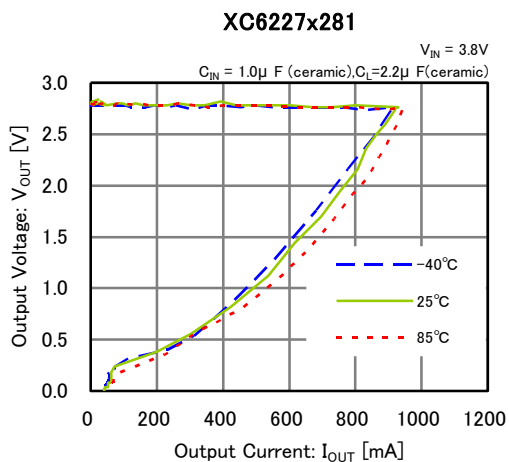
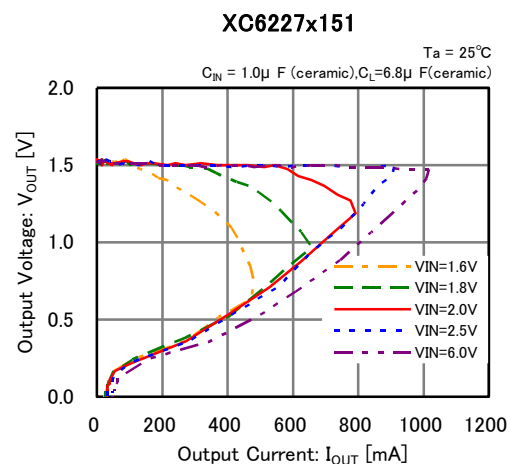
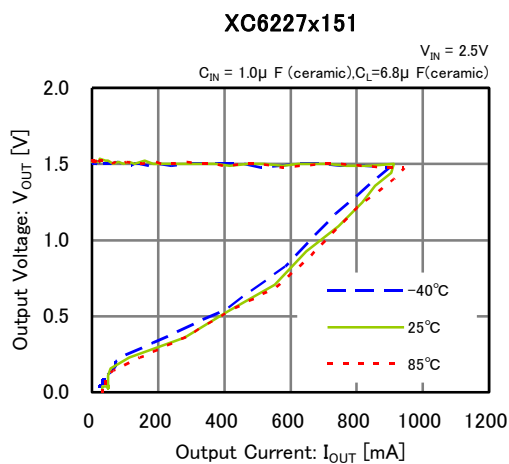
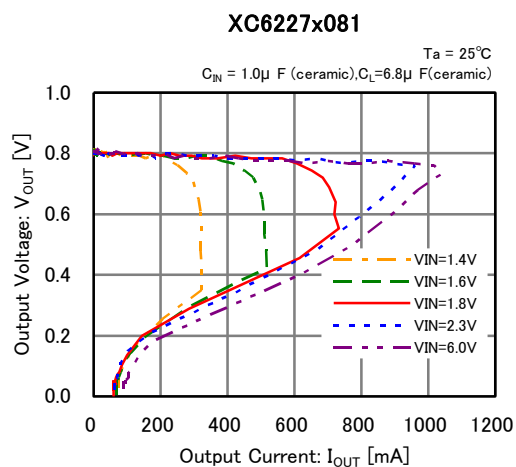
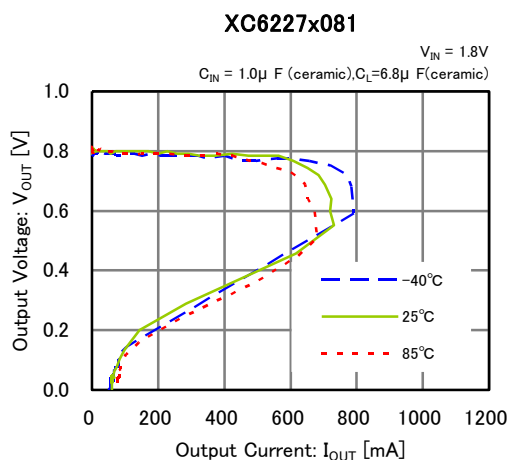

## TYPICAL PERFORMANCE CHARACTERISTICS (Continued)

(1) Output Voltage vs. Output Current (Continued)

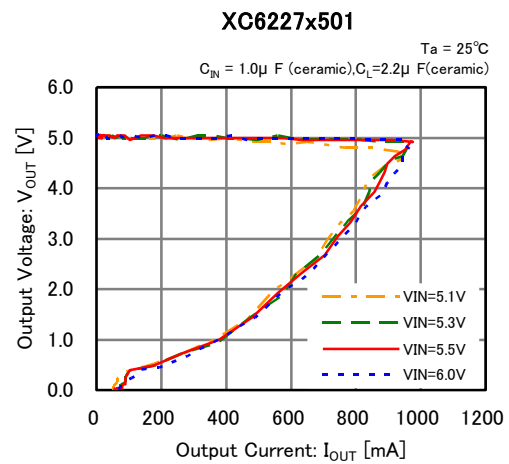
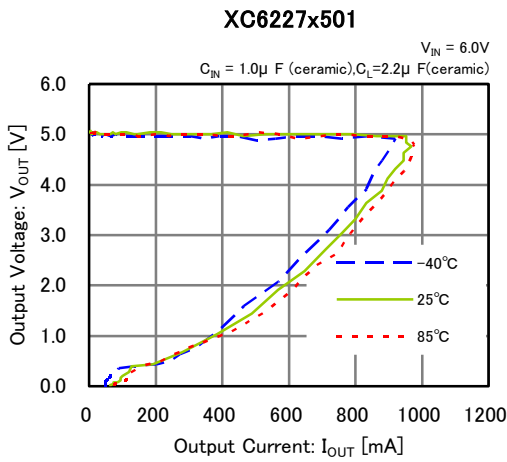

(2) Output Voltage vs. Input Voltage

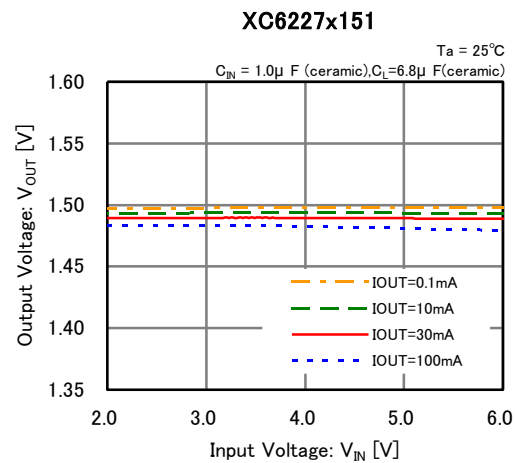
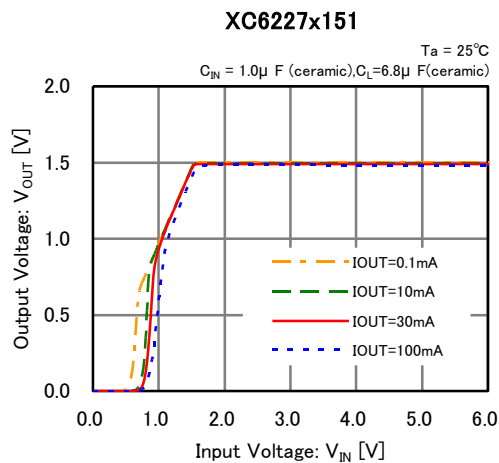
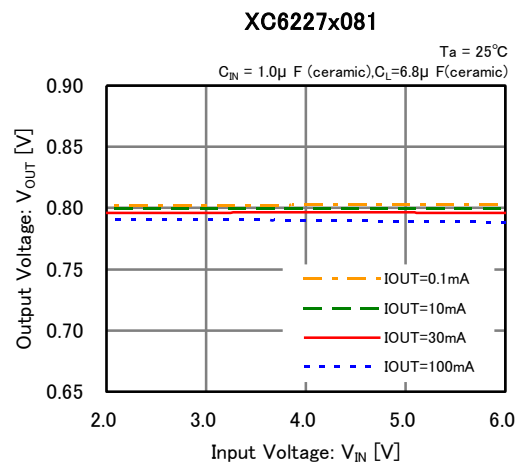
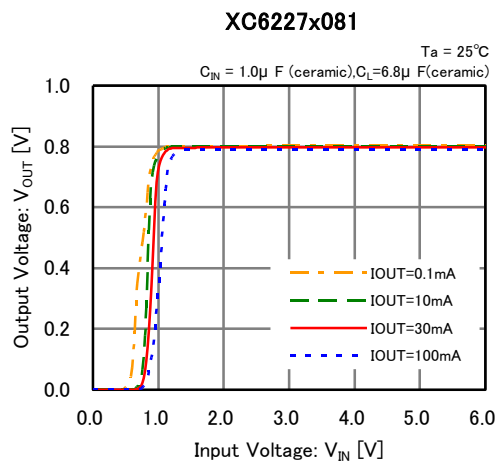

## ■ TYPICAL PERFORMANCE CHARACTERISTICS (Continued)

### (2) Output Voltage vs. Input Voltage (Continued)

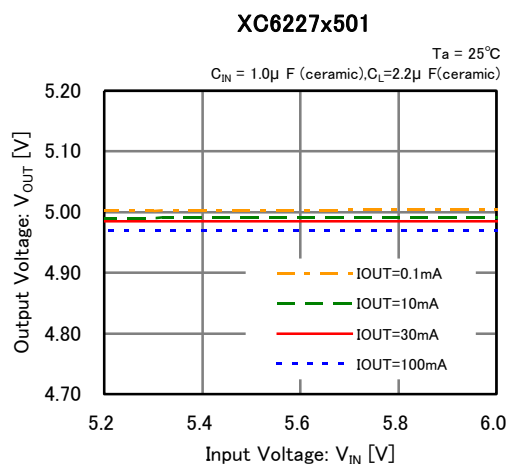
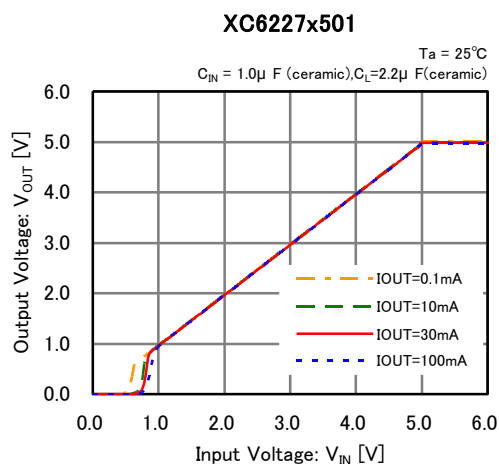
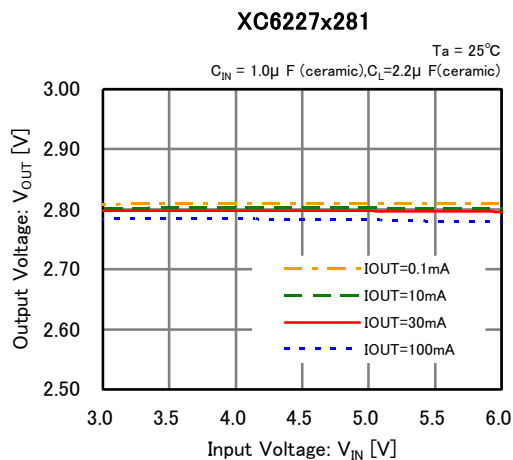
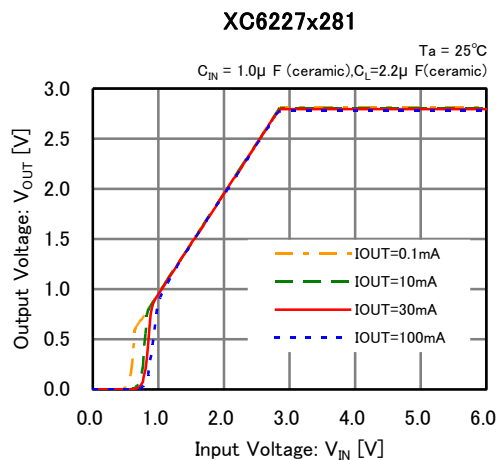

### (3) Dropout Voltage vs. Output Current

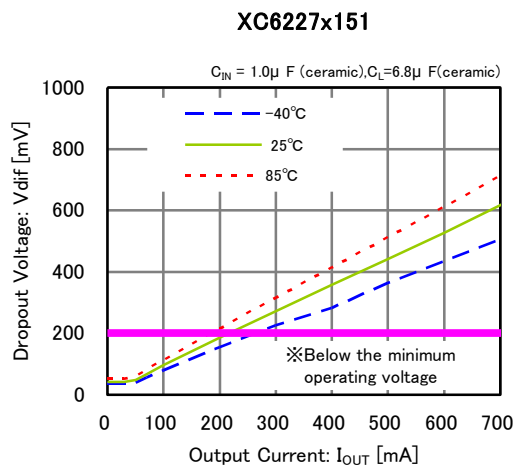
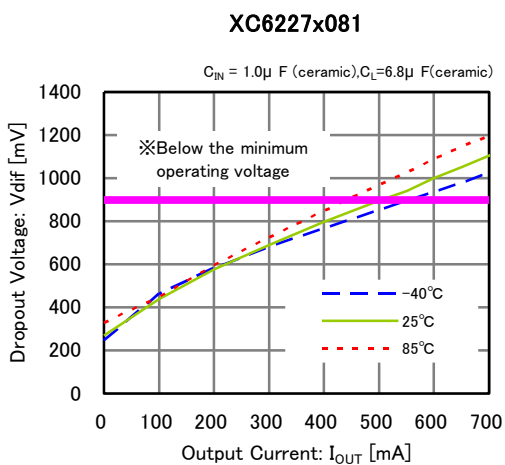

## TYPICAL PERFORMANCE CHARACTERISTICS (Continued)

(3) Dropout Voltage vs. Output Current (Continued)

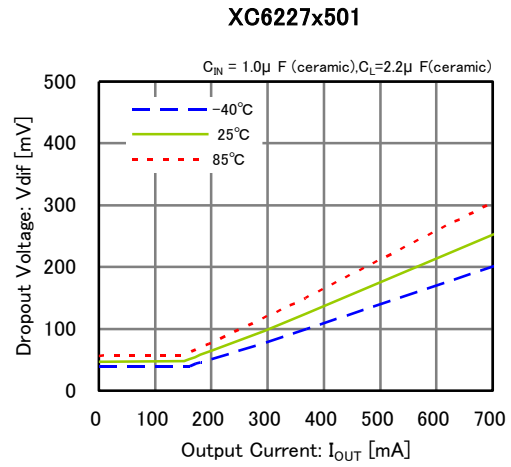
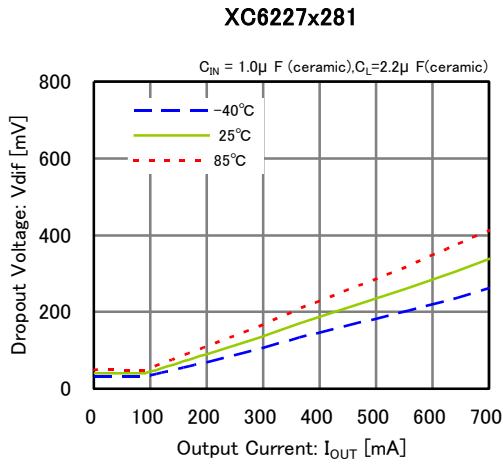

(4) Supply Current vs. Input Voltage

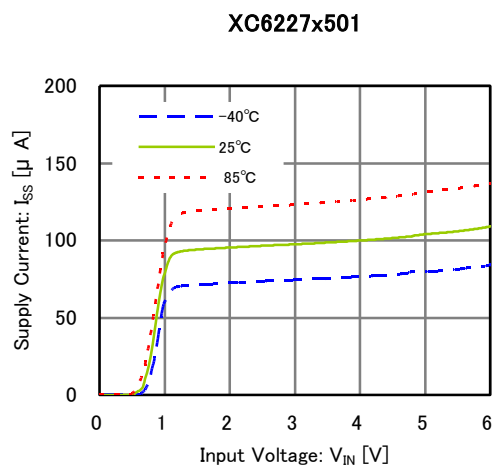
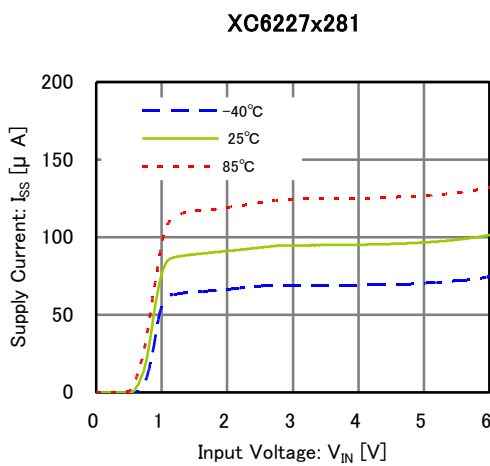
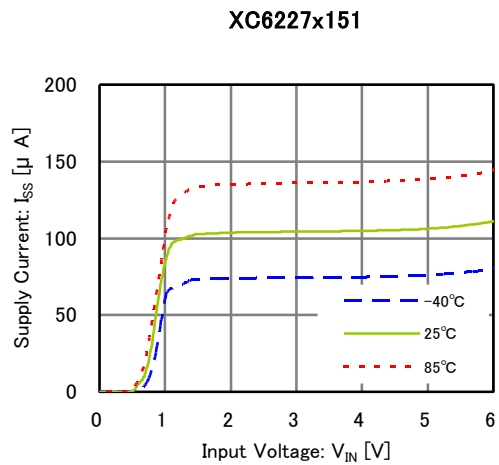
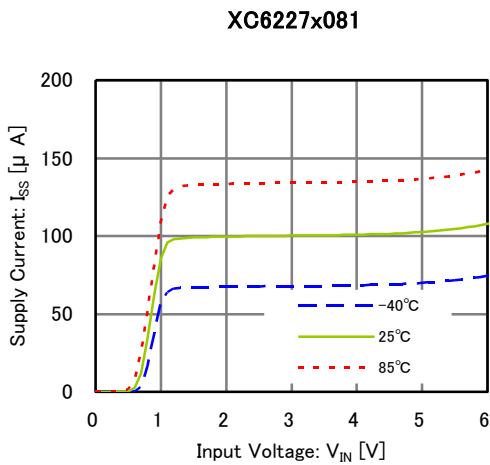

## TYPICAL PERFORMANCE CHARACTERISTICS (Continued)

(5) Output Voltage vs. Ambient Temperature

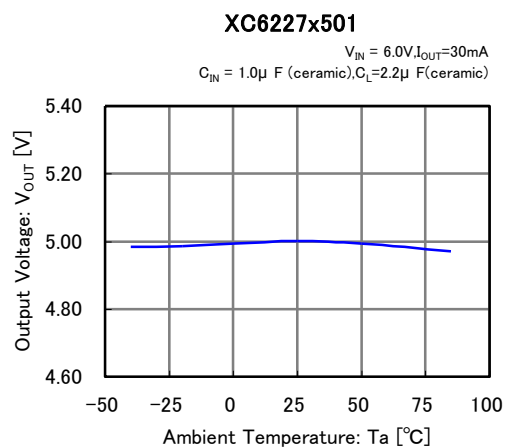
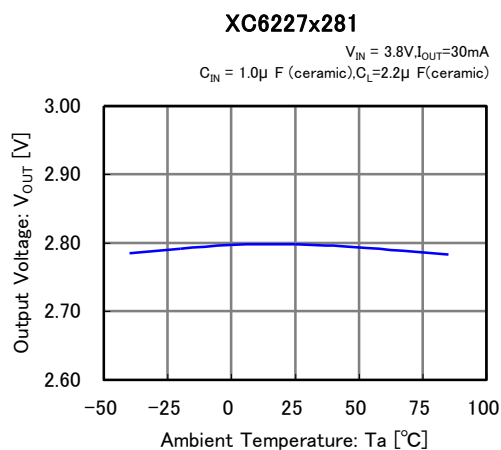
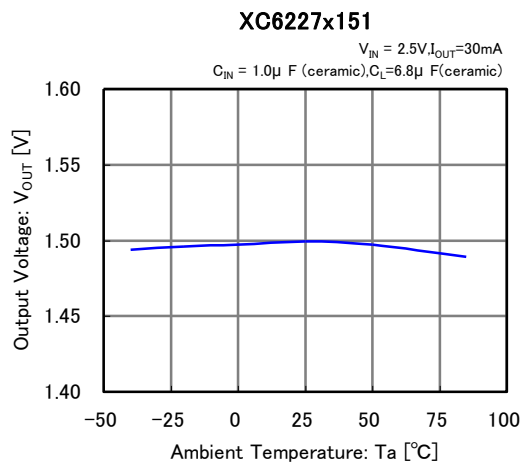
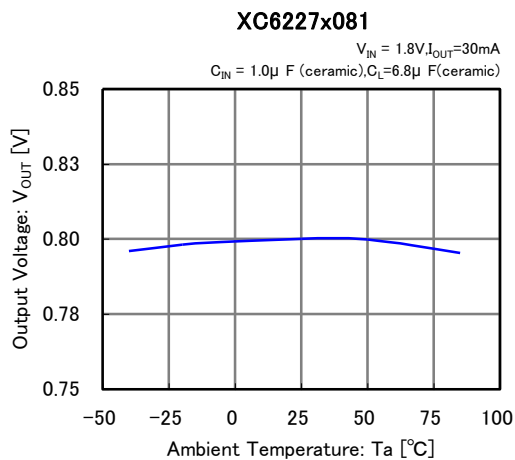

(6) CE Pin Threshold Voltage vs. Ambient Temperature

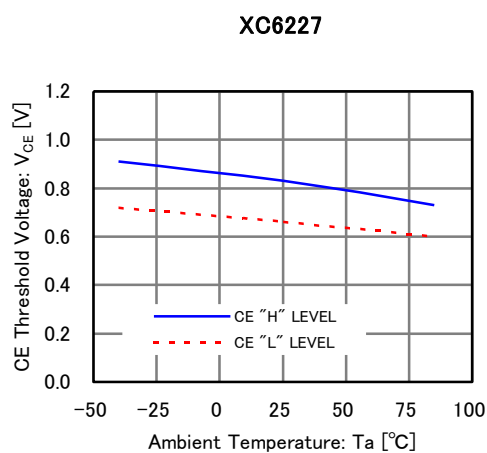

(7) Reverse Current vs. Output Voltage

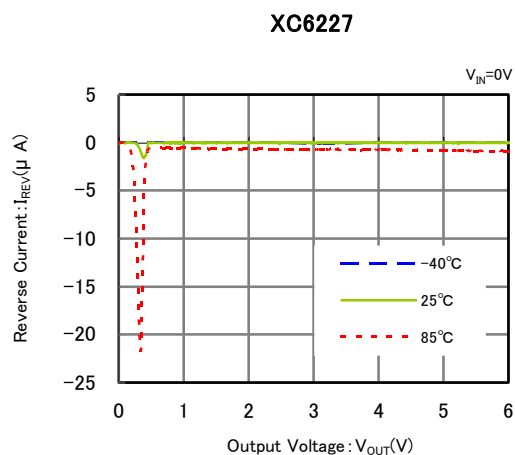

## TYPICAL PERFORMANCE CHARACTERISTICS (Continued)

(8)  $V_{OUT}$  Sink Current vs. Output Voltage

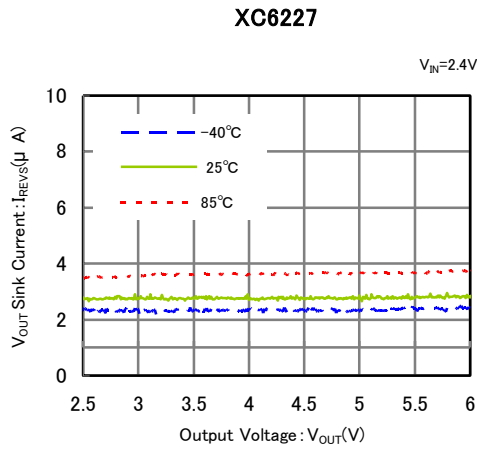

(9) Input Transient Response

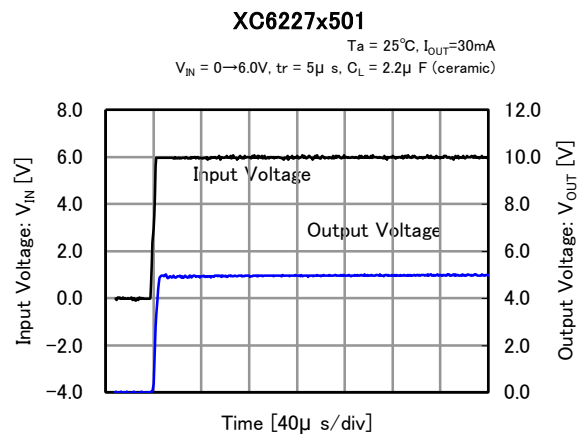
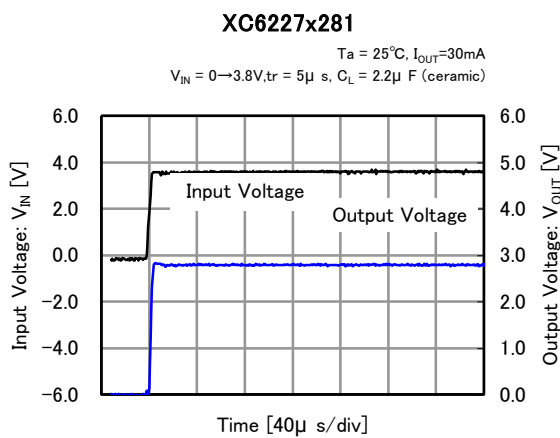
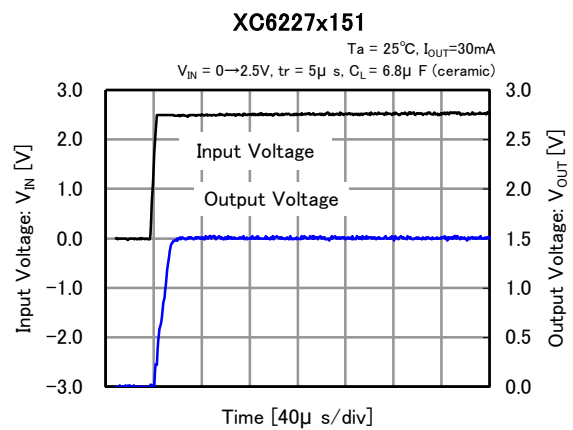
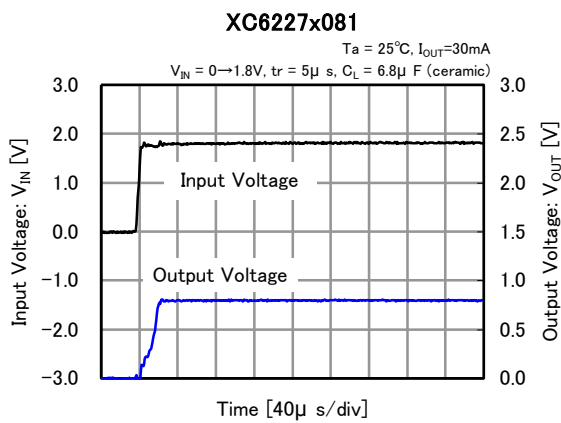



## TYPICAL PERFORMANCE CHARACTERISTICS (Continued)

### (10) CE Rising Response Time

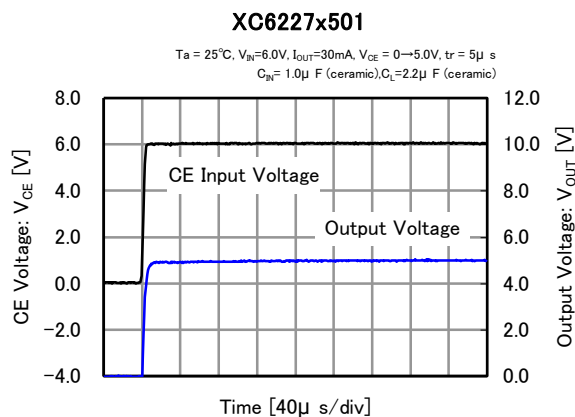
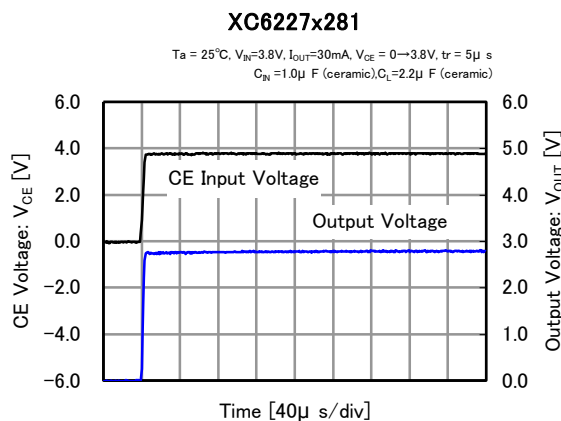
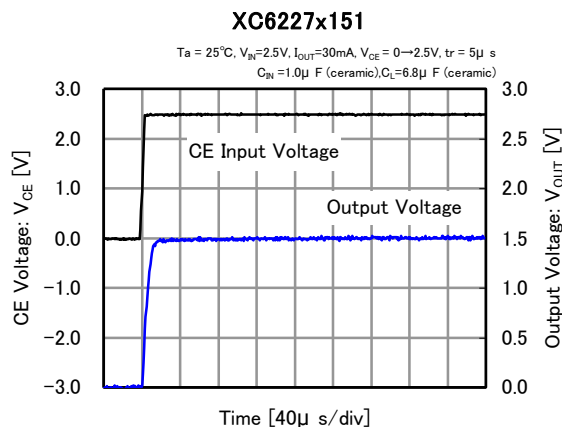
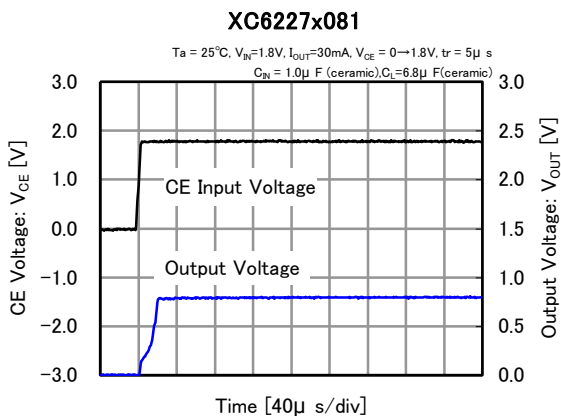

### (11) Input Transient Response

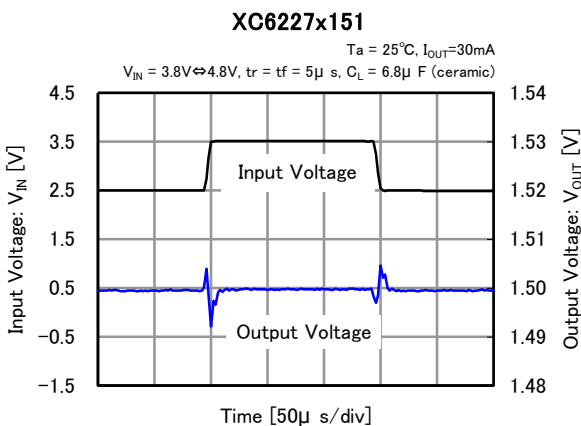
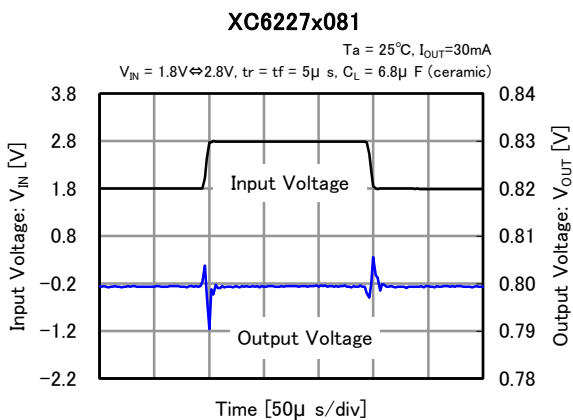

## TYPICAL PERFORMANCE CHARACTERISTICS (Continued)

### (11) Input Transient Response (Continued)

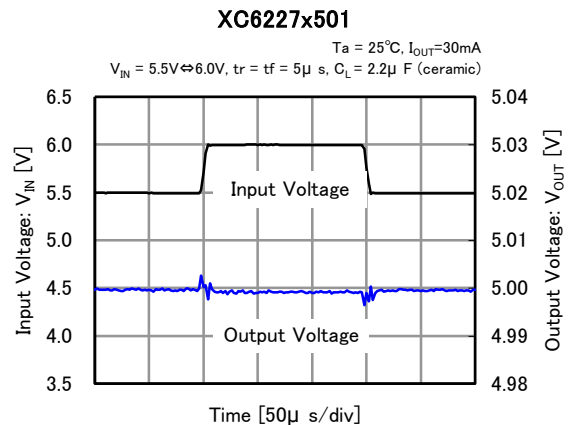
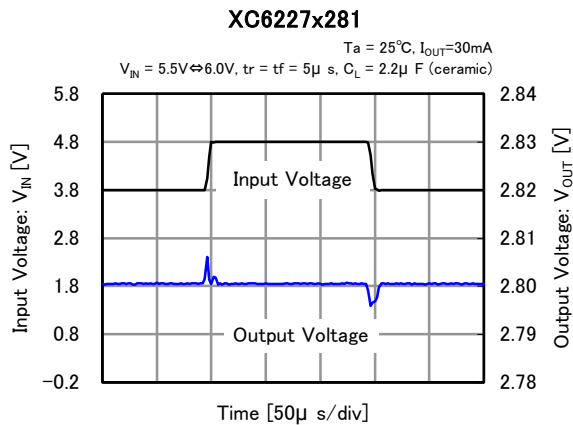

### (12) Load Transient Response

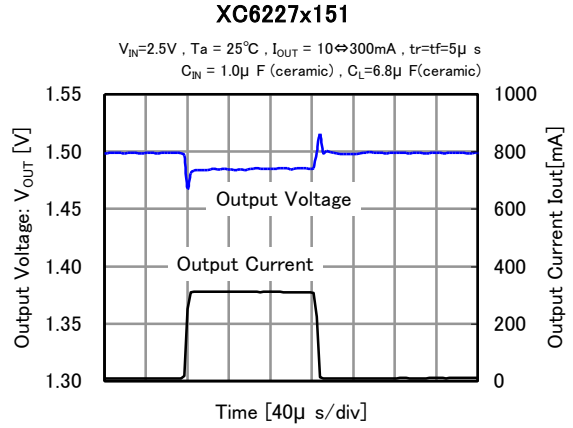
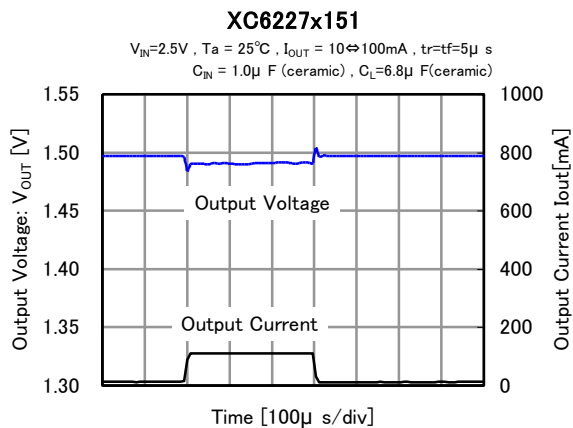
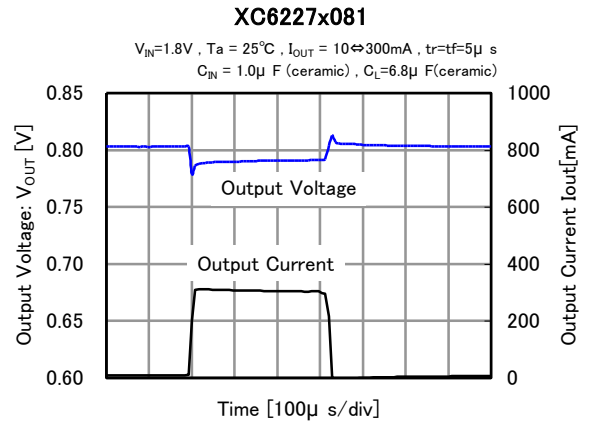
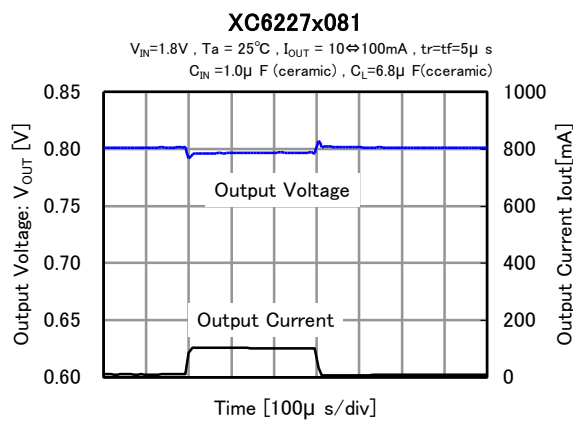

## ■ TYPICAL PERFORMANCE CHARACTERISTICS (Continued)

### (12) Load Transient Response (Continued)

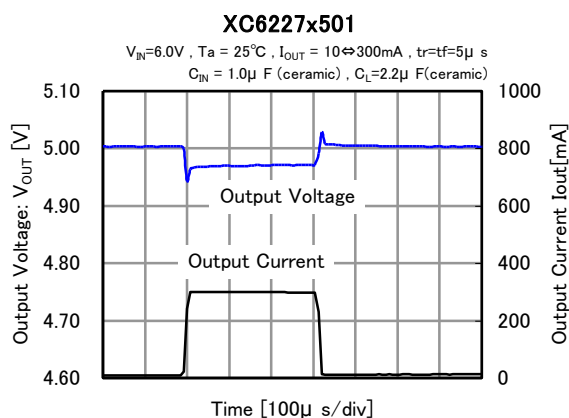
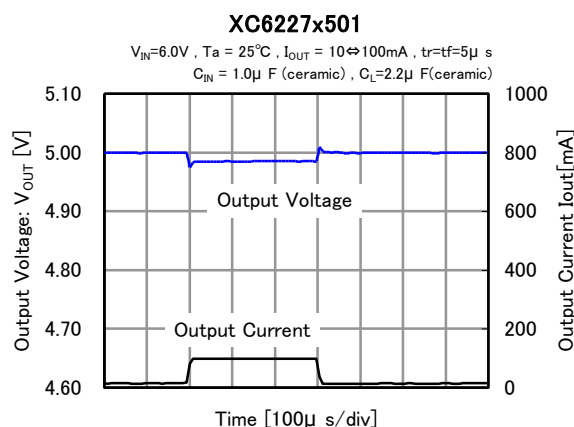
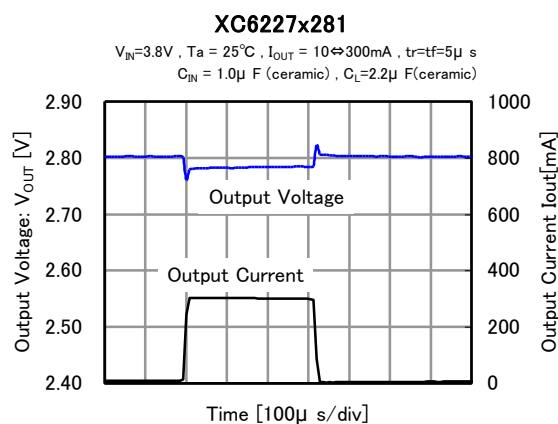
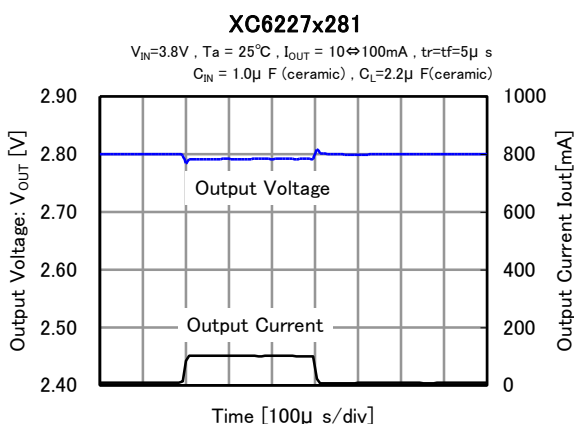

### (13) Ripple Rejection Rate

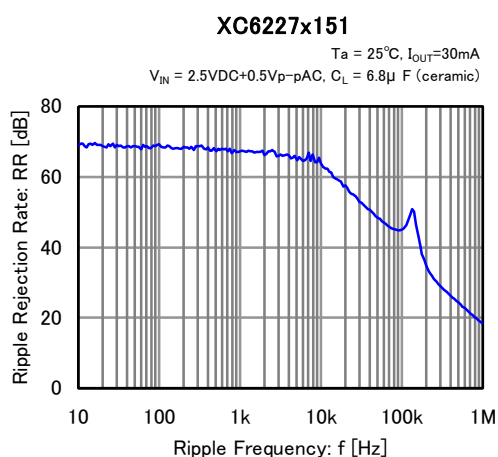
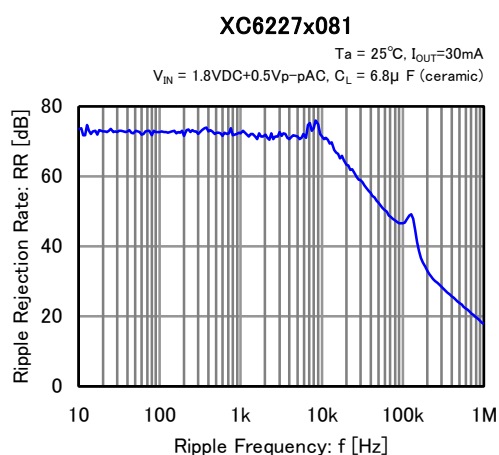

## TYPICAL PERFORMANCE CHARACTERISTICS (Continued)

### (13) Ripple Rejection Rate (Continued)

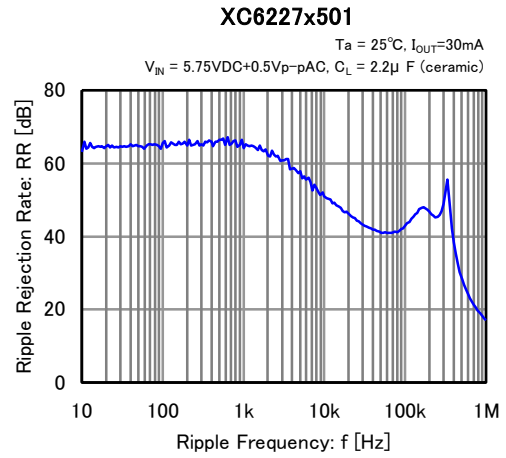
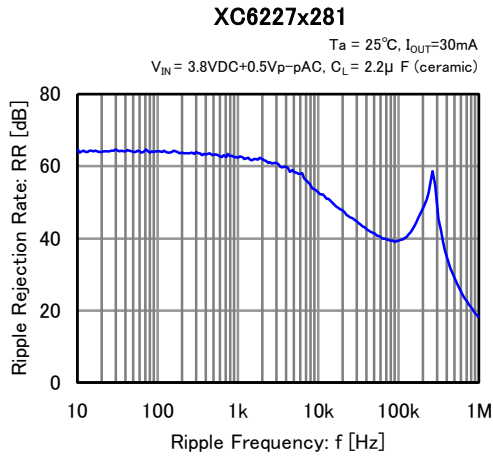

### (14) Output Noise Density

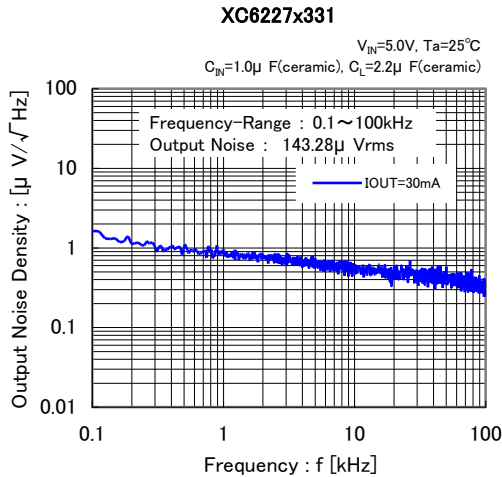
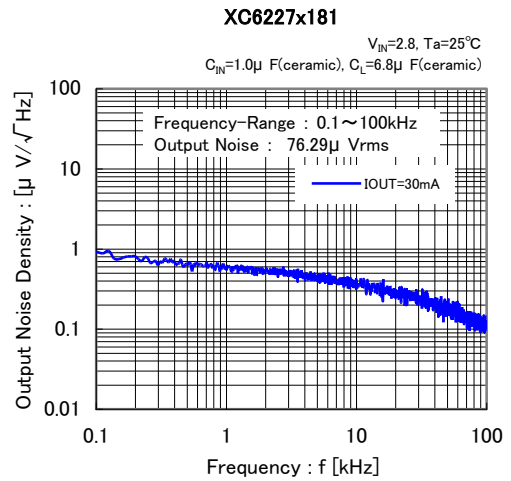
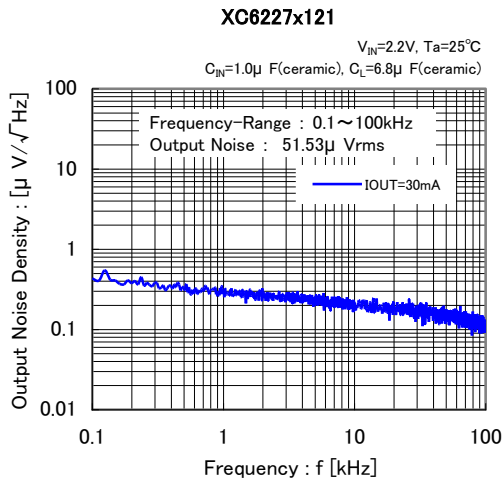

## ■ PACKAGING INFORMATION

For the latest package information go to, [www.torexsemi.com/technical-support/packages](http://www.torexsemi.com/technical-support/packages)

PACKAGE	OUTLINE / LAND PATTERN	THERMAL CHARACTERISTICS	
SOT-25	<a href="#">SOT-25 PKG</a>	Standard Board	<a href="#">SOT-25 Power Dissipation</a>
		JESD51-7 Board	
SOT-89-5	<a href="#">SOT-89-5 PKG</a>	Standard Board	<a href="#">SOT-89-5 Power Dissipation</a>
		JESD51-7 Board	
USP-6C	<a href="#">USP-6C PKG</a>	Standard Board	<a href="#">USP-6C Power Dissipation</a>
		JESD51-7 Board	

## MARKING RULE

● SOT-25 / SOT-89-5 / USP-6C

● SOT-25

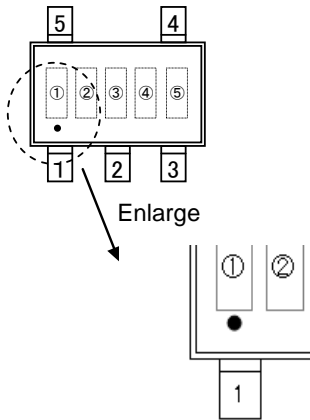

● SOT-89-5

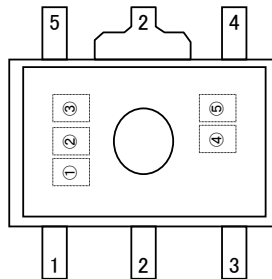

● USP-6C

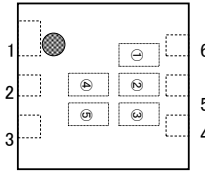

\* SOT-25 Under dot

① represents product series

MARK	PRODUCT SERIES
3	XC6227*****-G

② represents regulator type, voltage range, and accuracy

MARK	REGULATOR TYPE	OUTPUT VOLTAGE RANGE	ACCURACY	PRODUCT SERIES
A	A	0.8~2.9	1	XC6227A081**-G~XC6227A291**-G
B	A	0.85~2.95	B	XC6227A08B**-G~XC6227A29B**-G
C	A	3.0~5.0	1	XC6227A301**-G~XC6227A501**-G
D	A	3.05~4.95	B	XC6227A30B**-G~XC6227A49B**-G
E	C	0.8~2.9	1	XC6227C081**-G~XC6227C291**-G
F	C	0.85~2.95	B	XC6227C08B**-G~XC6227C29B**-G
H	C	3.0~5.0	1	XC6227C301**-G~XC6227C501**-G
K	C	3.05~4.95	B	XC6227C30B**-G~XC6227C49B**-G

\* Accuracy "1"- 0.1V step, Accuracy "B"- 0.05V step

③ represents output voltage.

MARK	OUTPUT VOLTAGE (V)		MARK	OUTPUT VOLTAGE (V)		MARK	OUTPUT VOLTAGE (V)	
0	-	3.0x	A	1.0x	4.0x	N	2.0x	5.0x
1	-	3.1x	B	1.1x	4.1x	P	2.1x	-
2	-	3.2x	C	1.2x	4.2x	R	2.2x	-
3	-	3.3x	D	1.3x	4.3x	S	2.3x	-
4	-	3.4x	E	1.4x	4.4x	T	2.4x	-
5	-	3.5x	F	1.5x	4.5x	U	2.5x	-
6	-	3.6x	H	1.6x	4.6x	V	2.6x	-
7	-	3.7x	K	1.7x	4.7x	X	2.7x	-
8	0.8x	3.8x	L	1.8x	4.8x	Y	2.8x	-
9	0.9x	3.9x	M	1.9x	4.9x	Z	2.9x	-

④⑤ represents production lot number

01 to 09, 0A to 0Z, 11 to 9Z, A1 to A9, AA to Z9, ZA to ZZ repeated. (G, I, J, O, Q, W excluded)

\* No character inversion used.