

## 28V Operation Voltage Regulator with Voltage Detector

## ■ GENERAL DESCRIPTION

The XC6408 series is a positive voltage regulator IC manufactured using CMOS process with 28V operation voltage. The series consists of a voltage reference, an error amplifier, a current limiter, a thermal shutdown circuit and a phase compensation circuit plus a driver transistor. The output voltage and the detect voltage are user selectable in 0.1V increments. The over current protection circuit and the thermal shutdown circuit are built-in. These two protection circuits will operate when the output current reaches current limit level or the junction temperature reaches temperature limit level. The XC6408D series monitors its output voltage and provides reset signal if its output voltage falls below the pre-set voltage. This reset time (release delay time) can be set by an external capacitor. The XC6408E series monitors an external power supply and enables the output to be turned off and the IC becomes a stand-by mode.

## ■ APPLICATIONS

- Note book computers, PDAs
- Car audio, Car navigation systems
- Home appliances
- Audio visuals, Digital cameras, Video cameras
- Cordless phones, Wireless communication

## ■ FEATURES

Max Output Current	: 150mA ( $V_{IN}=V_{ROUT}+3.0V$ )
Dropout Voltage	: 175mV @ $I_{OUT}=20mA$ ( $V_{ROUT}=12V$ )
Input Voltage Range	: 2.0V~28.0V
Output Voltage Range	: 2.0V~18.0V (0.1V increments)
Detect Voltage Range	: 2.0V~16.0V (0.1V increments)
High Accuracy(Regulator)	: $\pm 2\%$
(Detector)	$\pm 2.5\%$
Low Power Consumption	: XC6408D 9.5 $\mu A$ (TYP.) ( $V_{ROUT}=12V, V_{DF}=11V$ )
	: XC6408E 8 $\mu A$ (TYP.) ( $V_{ROUT}=12V, V_{DF}=11V$ )
Operating Temperature	: $-40^{\circ}C \sim +85^{\circ}C$
Packages	: SOT-89-5, SOT-25, USP-6C
Environmentally Friendly	: EU RoHS Compliant, Pb Free

## ■ TYPICAL APPLICATION CIRCUITS

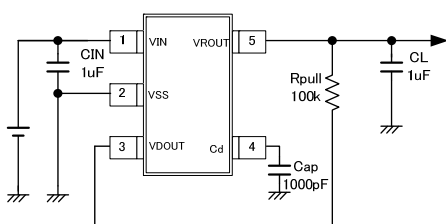

XC6408D Series

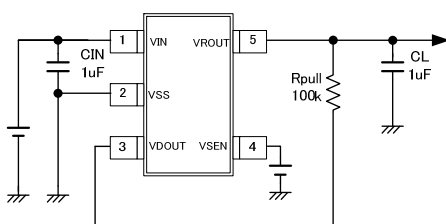

XC6408E Series

## ■ TYPICAL PERFORMANCE CHARACTERISTICS

- Supply Current vs. Input Voltage



## PIN CONFIGURATION

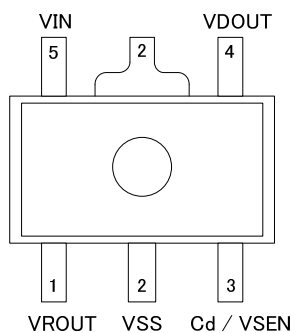

SOT-89-5  
(TOP VIEW)

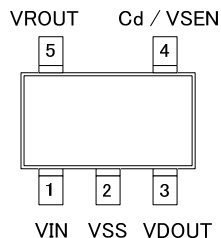

SOT-25  
(TOP VIEW)

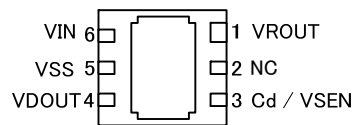

USP-6C  
(BOTTOM VIEW)

\* The dissipation pad for the USP-6C package should be solder-plated in reference mount pattern and metal masking to enhance mounting strength and heat release. If the pad needs to be connected to other pins, it should be connected to the V<sub>SS</sub> (No. 5) pin.

## PIN ASSIGNMENT

PIN NUMBER			PIN NAME	FUNCTIONS
SOT-89-5	SOT-25	USP-6C		
1	5	1	V <sub>ROUT</sub>	VR Output
2	2	5	V <sub>SS</sub>	Ground
3	4	3	V <sub>SEN</sub>	Sense(E series)
			Cd	Delay Capacitor(D series)
4	3	4	V <sub>DOUT</sub>	VD Output
5	1	6	V <sub>IN</sub>	Power Input
-	-	2	NC	No connection

## ■ PRODUCT CLASSIFICATION

### ● Selection Guide

XC6408D Series :  $V_{ROUT}$  pin voltage detection, release delay capacitor

XC6408E Series :  $V_{SEN}$  pin for external voltage detection, auto power ON/OFF function

### ● Ordering Information

XC6408D①②③④⑤-⑥ <sup>(\*)</sup>

DESIGNATOR	ITEM	SYMBOL	DESCRIPTION
①	$V_{DOUT}$ Output Configuration	N	Open Drain
②③	Output Voltage Detect Voltage	-	Sequential number relating to output voltage and detect voltage (refer to the chart below) $V_{ROUT}$ Output Voltage Range: 2.0V~18.0V $V_{DF}$ Detect Voltage Range: 2.0V~16.0V Output voltage and detect voltage can be set in 0.1V increments
④⑤-⑥	Packages (Order Unit)	ER-G	USP-6C (3,000/Reel)
		MR-G	SOT-25 (3,000/Reel)
		PR-G	SOT-89-5 (1,000/Reel)

<sup>(\*)</sup> The "-G" suffix indicates that the products are Halogen and Antimony free as well as being fully RoHS compliant.

DESIGNATOR②③ (No. 01~20 is standard voltage)

②③	$V_{ROUT}$	$V_{DF}$	②③	$V_{ROUT}$	$V_{DF}$
01	2.50	2.10	11	—	—
02	3.00	2.50	12	—	—
03	3.30	2.70	13	—	—
04	3.30	2.80	14	—	—
05	5.00	4.10	15	—	—
06	5.00	4.20	16	—	—
07	8.00	6.80	17	—	—
08	9.00	5.00	18	—	—
09	9.00	7.50	19	—	—
10	12.00	10.00	20	—	—

For other voltage, please contact your local Torex sales office or representative.

## ■ PRODUCT CLASSIFICATION

### ● Ordering Information

XC6408E①②③④⑤-⑥ (\*1)

DESIGNATOR	ITEM	SYMBOL	DESCRIPTION
①	V <sub>DOUT</sub> Output Configuration	N	Open Drain
②③	Output Voltage Detect Voltage	-	Sequential number relating to output voltage and detect voltage (refer to the chart below) V <sub>ROUT</sub> Output Voltage Range: 2.0V~18.0V V <sub>DF</sub> Detect Voltage Range: 2.0V~16.0V Output voltage and detect voltage can be set in 0.1V increments
④⑤-⑥	Packages (Order Unit)	ER-G	USP-6C (3,000/Reel)
		MR-G	SOT-25 (3,000/Reel)
		PR-G	SOT-89-5 (1,000/Reel)

(\*1) The "-G" suffix indicates that the products are Halogen and Antimony free as well as being fully RoHS compliant.

DESIGNATOR②③ (No. 01~20 is standard voltage)

②③	V <sub>ROUT</sub>	V <sub>DF</sub>	②③	V <sub>ROUT</sub>	V <sub>DF</sub>
01	2.50	2.10	11	2.50	2.70
02	3.00	2.50	12	2.50	2.80
03	3.30	2.70	13	3.00	4.10
04	3.30	2.80	14	3.00	4.20
05	5.00	4.10	15	3.30	4.10
06	5.00	4.20	16	3.30	4.20
07	8.00	6.80	17	5.00	5.60
08	9.00	5.00	18	5.00	6.80
09	9.00	7.50	19	9.00	10.00
10	12.00	10.00	20	12.00	15.00

For other voltage, please contact your local Torex sales office or representative.



## ABSOLUTE MAXIMUM RATINGS

### ●XC6408D Series

PARAMETER		SYMBOL	RATINGS	UNITS
Input Voltage		$V_{IN}$	$V_{SS}-0.3 \sim +30$	V
Delay Capacitor Voltage		$V_{Cd}$	$V_{SS}-0.3 \sim V_{IN}+0.3$	V
Delay Capacitor Current		$I_{Cd}$	5.0	mA
$V_{ROUT}$ Output Current		$I_{ROUT}$	210 <sup>(*)1</sup>	mA
$V_{DOUT}$ Output Current		$I_{DOUT}$	20	mA
$V_{ROUT}$ Output Voltage		$V_{ROUT}$	$V_{SS}-0.3 \sim V_{IN}+0.3$	V
$V_{DOUT}$ Output Voltage		$V_{DOUT}$	$V_{SS}-0.3 \sim +30$	V
Power Dissipation	USP-6C	Pd	120	mW
			1000 (PCB mounted) <sup>(*)2</sup>	
	SOT-25		250	
			600 (PCB mounted) <sup>(*)2</sup>	
			SOT-89-5	
1300 (PCB mounted) <sup>(*)2</sup>				
Operating Temperature Range		$T_{opr}$	-40 ~ +85	°C
Storage Temperature Range		$T_{stg}$	-55 ~ +125	°C

\*1:  $I_{OUT} \leq Pd / (V_{IN} - V_{ROUT})$

\*2: The power dissipation figure shown is PCB mounted. Please refer to page 30~32 for details.

### ●XC6408E

PARAMETER		SYMBOL	RATINGS	UNITS
Input Voltage		$V_{IN}$	$V_{SS}-0.3 \sim +30$	V
Sense Voltage		$V_{SEN}$	$V_{SS}-0.3 \sim +30$	V
$V_{ROUT}$ Output Current		$I_{ROUT}$	210 <sup>(*)1</sup>	mA
$V_{DOUT}$ Output Current		$I_{DOUT}$	20	mA
$V_{ROUT}$ Output Voltage		$V_{ROUT}$	$V_{SS}-0.3 \sim V_{IN}+0.3$	V
$V_{DOUT}$ Output Voltage		$V_{DOUT}$	$V_{SS}-0.3 \sim +30$	V
Power Dissipation	USP-6C	Pd	120	mW
			1000 (PCB mounted) <sup>(*)2</sup>	
	SOT-25		250	
			600 (PCB mounted) <sup>(*)2</sup>	
			SOT-89-5	
1300 (PCB mounted) <sup>(*)2</sup>				
Operating Temperature Range		$T_{opr}$	-40 ~ +85	°C
Storage Temperature Range		$T_{stg}$	-55 ~ +125	°C

\*1:  $Pd > (V_{IN} - V_{ROUT}) \times I_{ROUT}$

\*2: The power dissipation figure shown is PCB mounted. Please refer to page 30~32 for details.

## ELECTRICAL CHARACTERISTICS

●XC6408D Series

Ta=25°C

PARAMETER	SYMBOL	CONDITIONS	MIN.	TYP.	MAX.	UNITS	CIRCUIT	
Supply Current	I <sub>SS</sub>	2.0V ≤ V <sub>ROUT(T)</sub> ≤ 5.0V <sup>(*)1</sup>	1.5	9.6	20.5	μA	②	
		5.1V ≤ V <sub>ROUT(T)</sub> ≤ 12.0V <sup>(*)1</sup>	2.3	10	25.3			
		12.1V ≤ V <sub>ROUT(T)</sub> ≤ 18.0V <sup>(*)1</sup>	2.5	14.3	28.1			
Regulator Block	VR Output Voltage	V <sub>ROUT(E)</sub> <sup>(*)2</sup>	I <sub>OUT</sub> = 20mA	V <sub>ROUT(T)</sub> × 0.98 (E-1) <sup>(*)1</sup>	V <sub>ROUT(T)</sub> (E-1) <sup>(*)1</sup>	V <sub>ROUT(T)</sub> × 1.02 (E-1) <sup>(*)1</sup>	V	①
	VR Maximum Output Current	I <sub>ROUTMAX</sub>	V <sub>IN</sub> = V <sub>ROUT(T)</sub> + 3.0V, (V <sub>ROUT(T)</sub> ≥ 3.0V) <sup>(*)1</sup>	150	-	-	mA	①
			V <sub>IN</sub> = V <sub>ROUT(T)</sub> + 3.0V, (V <sub>ROUT(T)</sub> < 3.0V) <sup>(*)1</sup>	100	-	-		
	Load Regulation	ΔV <sub>ROUT</sub>	1mA ≤ I <sub>ROUT</sub> ≤ 50mA (2.0V ≤ V <sub>ROUT(T)</sub> ≤ 5.0V) <sup>(*)1</sup>	-	25	50	mV	①
			1mA ≤ I <sub>ROUT</sub> ≤ 50mA (5.0V < V <sub>ROUT(T)</sub> ≤ 12.0V) <sup>(*)1</sup>	-	60	120		
			1mA ≤ I <sub>ROUT</sub> ≤ 50mA (12.0V < V <sub>ROUT(T)</sub> ≤ 18.0V) <sup>(*)1</sup>	-	90	160		
	Dropout Voltage1 <sup>(*)3</sup>	V <sub>dif1</sub> <sup>(*)3</sup>	I <sub>ROUT</sub> = 20mA,	-	E-4		mV	①
	Dropout Voltage2 <sup>(*)3</sup>	V <sub>dif2</sub> <sup>(*)3</sup>	I <sub>ROUT</sub> = 100mA	-	E-5		mV	①
	Line Regulation1	ΔV <sub>ROUT</sub> / (ΔV <sub>IN</sub> · V <sub>ROUT</sub> )	V <sub>ROUT(T)</sub> + 2.0V ≤ V <sub>IN</sub> ≤ 28V <sup>(*)1</sup> I <sub>ROUT</sub> = 5mA	0.01	0.05	0.10	%/V	①
	Line Regulation2	ΔV <sub>ROUT</sub> / (ΔV <sub>IN</sub> · V <sub>ROUT</sub> )	V <sub>ROUT(T)</sub> + 2.0V ≤ V <sub>IN</sub> ≤ 28V <sup>(*)1</sup> I <sub>ROUT</sub> = 13mA	0.03	0.15	0.30	%/V	①
Input Voltage	V <sub>IN</sub>		2.0	-	28.0	V	-	
Output Voltage Temperature Characteristics	ΔV <sub>ROUT</sub> / (ΔT <sub>opr</sub> · V <sub>ROUT</sub> )	I <sub>ROUT</sub> = 20mA, -40°C ≤ T <sub>opr</sub> ≤ 85°C	-	± 100	-	ppm/°C	①	
Short Current	I <sub>RSHORT</sub>	V <sub>SEN</sub> = V <sub>DF(T)</sub> + 2V <sup>(*)1</sup>	-	30	-	mA	①	
Detector Block	VD Detect Voltage	V <sub>DF(E)</sub> <sup>(*)2</sup>		V <sub>DF(T)</sub> × 0.975 (E-2) <sup>(*)1</sup>	V <sub>DF(T)</sub> (E-2) <sup>(*)1</sup>	V <sub>DF(T)</sub> × 1.025 (E-2) <sup>(*)1</sup>	V	③
	Hysteresis Width	V <sub>HYS</sub>		E-3		V	③	
	Output Current	I <sub>DOUT</sub>	V <sub>IN</sub> = 3.0V, C <sub>d</sub> = 0V, V <sub>DS</sub> = 0.5V	0.3	0.5	-	mA	④
	Output Leakage Current	I <sub>DLEAK</sub>	V <sub>IN</sub> = 28V, C <sub>d</sub> = 0V, V <sub>DS</sub> = 28V	-	-	0.1	μA	④
	Detect Voltage Temperature Characteristics	ΔV <sub>DOUT</sub> / (ΔT <sub>opr</sub> · V <sub>DOUT</sub> )	-40°C ≤ T <sub>opr</sub> ≤ 85°C	-	± 100	-	ppm/°C	③
	Release Delay Time	t <sub>DR</sub>	Cap = 1000pF	3.4	6.0	15.6	ms	⑤
Thermal Shutdown Detect Temperature	T <sub>TSD</sub>	Junction Temperature	-	150	-	°C	①	
Thermal Shutdown Release Temperature	T <sub>TSR</sub>	Junction Temperature	-	125	-	°C	①	
Hysteresis Width	T <sub>TSR</sub> - T <sub>TSD</sub>	Junction Temperature	-	25	-	°C	-	

\*1: V<sub>ROUT(T)</sub>: Nominal output voltage, V<sub>DF(T)</sub>: Nominal detect voltage

\*2: V<sub>ROUT(E)</sub>: Effective output voltage, V<sub>DF(E)</sub>: Effective detect voltage

\*3: V<sub>dif</sub> = {V<sub>IN1</sub> <sup>(\*)5</sup> - V<sub>ROUT1</sub> <sup>(\*)4</sup>}

\*4: V<sub>ROUT1</sub>: In case of V<sub>ROUT(T)</sub> < 3.0V, the V<sub>OUT1</sub> is equal to 98% of the I<sub>ROUT(T)</sub> when a stabilized input voltage is applied in V<sub>ROUT(T)</sub> + 3.0V.  
In case of V<sub>ROUT(T)</sub> ≥ 3.0V, the V<sub>OUT1</sub> is equal to 98% of the I<sub>ROUT(T)</sub> when a stabilized input voltage is applied in V<sub>ROUT(T)</sub> + 2.0V.

\*5: V<sub>IN1</sub>: The input voltage when V<sub>ROUT1</sub> appears as input voltage is gradually decreased.

\*6: Unless otherwise stated, V<sub>IN</sub> = V<sub>ROUT(T)</sub> + 2.0V

## ELECTRICAL CHARACTERISTICS (Continued)

●XC6408E Series

Ta=25°C

PARAMETER	SYMBOL	CONDITIONS	MIN.	TYP.	MAX.	UNITS	CIRCUIT	
Supply Current	I <sub>SS</sub>	$V_{SEN}=V_{DF(T)}+2.0V$ ( $2.0V \leq V_{ROUT(T)} \leq 5.0V$ ) <sup>(*)1</sup>	1.5	6.5	17.6	μA	②	
		$V_{SEN}=V_{DF(T)}+2.0V$ ( $5.1V \leq V_{ROUT(T)} \leq 12.0V$ ) <sup>(*)1</sup>	2.1	8	17.6			
		$V_{SEN}=V_{DF(T)}+2.0V$ ( $12.1V \leq V_{ROUT(T)} \leq 18.0V$ ) <sup>(*)1</sup>	2.2	8.5	17.6			
VD Supply Current	I <sub>DSS</sub>	$V_{SEN}=V_{SS}$	-	1.5	3.9	μA	②	
Regulator Block	VR Output Voltage	$V_{ROUT(E)}$ <sup>(*)2</sup>	$V_{SEN}=V_{DF(T)}+2.0V$ $I_{ROUT}=20mA$	$V_{ROUT(T)} \times 0.98$ (E-1) <sup>(*)1</sup>	$V_{ROUT(T)}$ (E-1) <sup>(*)1</sup>	$V_{ROUT(T)} \times 1.02$ (E-1) <sup>(*)1</sup>	V	①
	VR Maximum Output Current	I <sub>ROUTMAX</sub>	$V_{IN}=V_{ROUT(T)}+3.0V$ $V_{SEN}=V_{DF(T)}+2.0V$ ( $V_{ROUT(T)} \geq 3.0V$ )	150	-	-	mA	①
			$V_{IN}=V_{ROUT(T)}+3.0V$ $V_{SEN}=V_{DF(T)}+2.0V$ ( $V_{ROUT(T)} < 3.0V$ ) <sup>(*)1</sup>	100	-	-		
	Load Regulation	ΔV <sub>ROUT</sub>	$V_{SEN}=V_{DF(T)}+2.0V$ $1mA \leq I_{ROUT} \leq 50mA$ ( $2.0 \leq V_{ROUT(T)} \leq 5.0V$ ) <sup>(*)1</sup>	-	25	50	mV	①
			$V_{SEN}=V_{DF(T)}+2.0V$ $1mA \leq I_{ROUT} \leq 50mA$ ( $5.0 < V_{ROUT(T)} \leq 12.0V$ ) <sup>(*)1</sup>	-	60	120		
			$V_{SEN}=V_{DF(T)}+2.0V$ $1mA \leq I_{ROUT} \leq 50mA$ ( $12.0 < V_{ROUT(T)} \leq 18.0V$ ) <sup>(*)1</sup>	-	90	160		
	Dropout Voltage1 <sup>(*)3</sup>	Vdif1 <sup>(*)3</sup>	$I_{ROUT}=20mA$	-	(E-4)		mV	①
	Dropout Voltage2 <sup>(*)3</sup>	Vdif2 <sup>(*)3</sup>	$I_{ROUT}=100mA$	-	(E-5)		mV	①
	Line Regulation1	$\frac{\Delta V_{ROUT}}{(\Delta V_{IN} \cdot V_{ROUT})}$	$V_{SEN}=V_{DF(T)}+2.0V$ $V_{ROUT(T)}+2.0V \leq V_{IN} \leq 28V$ <sup>(*)1</sup> $I_{ROUT}=5mA$	0.01	0.05	0.10	%/V	①
	Line Regulation2	$\frac{\Delta V_{ROUT}}{(\Delta V_{IN} \cdot V_{ROUT})}$	$V_{SEN}=V_{DF(T)}+2.0V$ $V_{ROUT(T)}+2.0V \leq V_{IN} \leq 28V$ <sup>(*)1</sup> $I_{ROUT}=13mA$	0.03	0.15	0.30	%/V	①
	Input Voltage	V <sub>IN</sub>		2.0	-	28.0	V	-
	Output Voltage Temperature Characteristics	$\frac{\Delta V_{ROUT}}{(\Delta T_{opr} \cdot V_{ROUT})}$	$V_{SEN}=V_{DF(T)}+2.0V$ <sup>(*)1</sup> $I_{ROUT}=20mA$ $-40^\circ C \leq T_{opr} \leq 85^\circ C$	-	±100	-	ppm/°C	①
Short Current	I <sub>RSHORT</sub>	$V_{SEN}=V_{DF(T)}+2.0V$ <sup>(*)1</sup>	-	30	-	mA	①	
Detector Block	VD Detect Voltage	$V_{DF(E)}$ <sup>(*)2</sup>		$V_{DF(T)} \times 0.975$ (E-2) <sup>(*)1</sup>	$V_{DF(T)}$ (E-2) <sup>(*)1</sup>	$V_{DF(T)} \times 1.025$ (E-2) <sup>(*)1</sup>	V	③
	Hysteresis Width	V <sub>HYS</sub>		(E-3)		V	③	
	Output Current	I <sub>DOUT</sub>	$V_{IN}=3.0V, V_{SEN}=V_{DF(T)}-0.4V$ <sup>(*)1</sup> $V_{DS}=0.5V$	0.3	0.5	-	mA	④
	Output Leakage Current	I <sub>DLEAK</sub>	$V_{IN}=28V, V_{SEN}=0V, V_{DS}=28V$	-	-	0.1	μA	④
	Detect Voltage Temperature Characteristics	$\frac{\Delta V_{DOUT}}{(\Delta T_{opr} \cdot V_{DOUT})}$	$-40^\circ C \leq T_{opr} \leq 85^\circ C$	-	±100	-	ppm/°C	③
	SENSE Input Current	I <sub>SENSE</sub>	$V_{SEN}=V_{DF(T)}+2.0V$ <sup>(*)1</sup>	(E-6)		μA	⑥	
Thermal Shutdown Detect Temperature	T <sub>TSD</sub>	Junction Temperature	-	150	-	°C	①	
Thermal Shutdown Release Temperature	T <sub>TSR</sub>	Junction Temperature	-	125	-	°C	①	
Hysteresis Width	T <sub>TSR</sub> - T <sub>TSD</sub>	Junction Temperature	-	25	-	°C	-	

\*1: V<sub>ROUT(T)</sub>: Nominal output voltage, V<sub>DF(T)</sub>: Nominal detect voltage

\*2: V<sub>ROUT(E)</sub>: Effective output voltage, V<sub>DF(E)</sub>: Effective detect voltage

\*3: Vdif = {V<sub>IN1</sub><sup>(\*)5</sup> - V<sub>ROUT1</sub><sup>(\*)4</sup>}

\*4: V<sub>ROUT1</sub>: In case of V<sub>ROUT(T)</sub> < 3.0V, the V<sub>OUT1</sub> is equal to 98% of the I<sub>ROUT(T)</sub> when a stabilized input voltage is applied in V<sub>ROUT(T)</sub>+3.0V. In case of V<sub>ROUT(T)</sub> ≥ 3.0V, the V<sub>OUT1</sub> is equal to 98% of the I<sub>ROUT(T)</sub> when a stabilized input voltage is applied in V<sub>ROUT(T)</sub>+2.0V.

\*5: V<sub>IN1</sub>: The input voltage when V<sub>ROUT1</sub> appears as input voltage is gradually decreased.

\*6: Unless otherwise stated, V<sub>IN</sub>=V<sub>ROUT(T)</sub>+2.0V



## ■ ELECTRICAL CHARACTERISTICS (Continued)

### ● Voltage Chart

(\*1) $V_{ROUT}$ : Accuracy  $\pm 2\%$ ,  $V_{DF}$ : Accuracy  $\pm 2.5\%$

SYMBOL	E-1		E-2		E-3		E-4		E-5		E-6	
NOMINAL VR OUTPUT VOLTAGE VD DETECT VOLTAGE (V)	VR OUTPUT VOLTAGE (V)		VD DETECT VOLTAGE (V)		HYSTERESIS WIDTH (V)		DROPOUT VOLTAGE1 $I_{ROUT}=20mA$ (mV)		DROPOUT VOLTAGE2 $I_{ROUT}=100mA$ (mV)		SENSE INPUT CURRENT ( $\mu A$ )	
$V_{ROUT(T)}$ $V_{DF(T)}$	$V_{ROUT(E)}$		$V_{DF(E)}$		$V_{HYS}$		Vdif1		Vdif2		Isense	
	MIN.	MAX.	MIN.	MAX.	MIN.	MAX.	TYP	MAX	TYP	MAX	MIN	MAX
2.0	1.960	2.040	1.950	2.050	$V_{DF(E)} \times 2\%$	$V_{DF(E)} \times 8\%$	500	680	2300	3300	0.1	2.2
2.1	2.058	2.142	2.048	2.153								
2.2	2.156	2.244	2.145	2.255								
2.3	2.254	2.346	2.243	2.358			430	600	1950	2950		
2.4	2.352	2.448	2.340	2.460								
2.5	2.450	2.550	2.438	2.563								
2.6	2.548	2.652	2.535	2.665								
2.7	2.646	2.754	2.633	2.768			360	530	1550	2550		
2.8	2.744	2.856	2.730	2.870								
2.9	2.842	2.958	2.828	2.973								
3.0	2.940	3.060	2.925	3.075								
3.1	3.038	3.162	3.023	3.178								
3.2	3.136	3.264	3.120	3.280								
3.3	3.234	3.366	3.218	3.383								
3.4	3.332	3.468	3.315	3.485			250	380	1100	1800		
3.5	3.430	3.570	3.413	3.588								
3.6	3.528	3.672	3.510	3.690								
3.7	3.626	3.774	3.608	3.793								
3.8	3.724	3.876	3.705	3.895								
3.9	3.822	3.978	3.803	3.998								
4.0	3.920	4.080	3.900	4.100								
4.1	4.018	4.182	3.998	4.203								
4.2	4.116	4.284	4.095	4.305								
4.3	4.214	4.386	4.193	4.408								
4.4	4.312	4.488	4.290	4.510			230	350	850	1650		
4.5	4.410	4.590	4.388	4.613								
4.6	4.508	4.692	4.485	4.715								
4.7	4.606	4.794	4.583	4.818								
4.8	4.704	4.896	4.680	4.920								
4.9	4.802	4.998	4.778	5.023								
5.0	4.900	5.100	4.875	5.125								
5.1	4.998	5.202	4.973	5.228								
5.2	5.096	5.304	5.070	5.330								
5.3	5.194	5.406	5.168	5.433								
5.4	5.292	5.508	5.265	5.535	180	300	750	1350				
5.5	5.390	5.610	5.363	5.638								
5.6	5.488	5.712	5.460	5.740								
5.7	5.586	5.814	5.558	5.843								
5.8	5.684	5.916	5.655	5.945								
5.9	5.782	6.018	5.753	6.048								

## ■ ELECTRICAL CHARACTERISTICS (Continued)

### ● Voltage Chart (Continued)

(\*1) $V_{ROUT}$ : Accuracy  $\pm 2\%$ ,  $V_{DF}$ : Accuracy  $\pm 2.5\%$

SYMBOL	E-1		E-2		E-3		E-4		E-5		E-6	
NOMINAL VR OUTPUT VOLTAGE VD DETECT VOLTAGE (V)	VR OUTPUT VOLTAGE (V)		VD DETECT VOLTAGE (V)		HYSTERESIS WIDTH (V)		DROPOUT VOLTAGE1 $I_{ROUT}=20mA$ (mV)		DROPOUT VOLTAGE2 $I_{ROUT}=100mA$ (mV)		SENSE INPUT CURRENT ( $\mu A$ )	
$V_{ROUT(T)}$ $V_{DF(T)}$	$V_{ROUT(E)}$		$V_{DF(E)}$		$V_{HYS}$		Vdif1		Vdif2		Isense	
	MIN.	MAX.	MIN.	MAX.	MIN.	MAX.	TYP	MAX	TYP	MAX	MIN	MAX
6.0	5.880	6.120	5.850	6.150	$V_{DF(E)} \times 2\%$	$V_{DF(E)} \times 8\%$	180	300	750	1350	0.1	4.1
6.1	5.978	6.222	5.948	6.253								
6.2	6.076	6.324	6.045	6.355								
6.3	6.174	6.426	6.143	6.458								
6.4	6.272	6.528	6.240	6.560								
6.5	6.370	6.630	6.338	6.663								
6.6	6.468	6.732	6.435	6.765								
6.7	6.566	6.834	6.533	6.868								
6.8	6.664	6.936	6.630	6.970								
6.9	6.762	7.038	6.728	7.073								
7.0	6.860	7.140	6.825	7.175								
7.1	6.958	7.242	6.923	7.278								
7.2	7.056	7.344	7.020	7.380								
7.3	7.154	7.446	7.118	7.483								
7.4	7.252	7.548	7.215	7.585								
7.5	7.350	7.650	7.313	7.688								
7.6	7.448	7.752	7.410	7.790								
7.7	7.546	7.854	7.508	7.893								
7.8	7.644	7.956	7.605	7.995								
7.9	7.742	8.058	7.703	8.098								
8.0	7.840	8.160	7.800	8.200								
8.1	7.938	8.262	7.898	8.303								
8.2	8.036	8.364	7.995	8.405								
8.3	8.134	8.466	8.093	8.508								
8.4	8.232	8.568	8.190	8.610								
8.5	8.330	8.670	8.288	8.713								
8.6	8.428	8.772	8.385	8.815								
8.7	8.526	8.874	8.483	8.918								
8.8	8.624	8.976	8.580	9.020								
8.9	8.722	9.078	8.678	9.123								
9.0	8.820	9.180	8.775	9.225								
9.1	8.918	9.282	8.873	9.328								
9.2	9.016	9.384	8.970	9.430								
9.3	9.114	9.486	9.068	9.533								
9.4	9.212	9.588	9.165	9.635								
9.5	9.310	9.690	9.263	9.738								
9.6	9.408	9.792	9.360	9.840								
9.7	9.506	9.894	9.458	9.943								
9.8	9.604	9.996	9.555	10.045								
9.9	9.702	10.098	9.653	10.148								
10.0	9.800	10.200	9.750	10.250								

**■ ELECTRICAL CHARACTERISTICS (Continued)**

(\*1) $V_{ROUT}$ : Accuracy  $\pm 2\%$ ,  $V_{DF}$ : Accuracy  $\pm 2.5\%$

SYMBOL	E-1		E-2		E-3		E-4		E-5		E-6	
NOMINAL VR OUTPUT VOLTAGE VD DETECT VOLTAGE (V)	VR OUTPUT VOLTAGE (V)		VD DETECT VOLTAGE (V)		HYSTERESIS WIDTH (V)		DROPOUT VOLTAGE1 $I_{ROUT}=20mA$ (mV)		DROPOUT VOLTAGE2 $I_{ROUT}=100mA$ (mV)		SENSE INPUT CURRENT ( $\mu A$ )	
$V_{ROUT(T)}$ $V_{DF(T)}$	$V_{ROUT(E)}$		$V_{DF(E)}$		$V_{HYS}$		Vdif1		Vdif2		Isense	
	MIN.	MAX.	MIN.	MIN.	MIN.	MIN.	TYP	MAX	TYP	MAX	MIN	MAX
10.1	9.898	10.302	9.848	10.353	$V_{DF(E)} \times 2\%$	$V_{DF(E)} \times 8\%$						
10.2	9.996	10.404	9.945	10.455								
10.3	10.094	10.506	10.043	10.558								
10.4	10.192	10.608	10.140	10.660								
10.5	10.290	10.710	10.238	10.763								
10.6	10.388	10.812	10.335	10.865								
10.7	10.486	10.914	10.433	10.968								
10.8	10.584	11.016	10.530	11.070								
10.9	10.682	11.118	10.628	11.173								
11.0	10.780	11.220	10.725	11.275								
11.1	10.878	11.322	10.823	11.378	$V_{DF(E)} \times 1\%$	$V_{DF(E)} \times 7\%$	150	200	400	850	0.1	4.1
11.2	10.976	11.424	10.920	11.480								
11.3	11.074	11.526	11.018	11.583								
11.4	11.172	11.628	11.115	11.685								
11.5	11.270	11.730	11.213	11.788								
11.6	11.368	11.832	11.310	11.890								
11.7	11.466	11.934	11.408	11.993								
11.8	11.564	12.036	11.505	12.095								
11.9	11.662	12.138	11.603	12.198								
12.0	11.760	12.240	11.700	12.300								
12.1	11.858	12.342	11.798	12.403								
12.2	11.956	12.444	11.895	12.505								
12.3	12.054	12.546	11.993	12.608								
12.4	12.152	12.648	12.090	12.710								
12.5	12.250	12.750	12.188	12.813								
12.6	12.348	12.852	12.285	12.915								
12.7	12.446	12.954	12.383	13.018								
12.8	12.544	13.056	12.480	13.120								
12.9	12.642	13.158	12.578	13.223								
13.0	12.740	13.260	12.675	13.325								
13.1	12.838	13.362	12.773	13.428	120	170	350	800	0.6	6.6		
13.2	12.936	13.464	12.870	13.530								
13.3	13.034	13.566	12.968	13.633								
13.4	13.132	13.668	13.065	13.735								
13.5	13.230	13.770	13.163	13.838								
13.6	13.328	13.872	13.260	13.940								
13.7	13.426	13.974	13.358	14.043								
13.8	13.524	14.076	13.455	14.145								
13.9	13.622	14.178	13.553	14.248								
14.0	13.720	14.280	13.650	14.350								

## ELECTRICAL CHARACTERISTICS (Continued)

(\*1) $V_{ROUT}$ : Accuracy  $\pm 2\%$ ,  $V_{DF}$ : Accuracy  $\pm 2.5\%$

SYMBOL	E-1		E-2		E-3		E-4		E-5		E-6		
NOMINAL VR OUTPUT VOLTAGE VD DETECT VOLTAGE (V)	VR OUTPUT VOLTAGE (V)		VD DETECT VOLTAGE (V)		HYSTERESIS WIDTH (V)		DROPOUT VOLTAGE1 $I_{ROUT}=20mA$ (mV)		DROPOUT VOLTAGE2 $I_{ROUT}=100mA$ (mV)		SENSE INPUT CURRENT ( $\mu A$ )		
$V_{ROUT(T)}$ $V_{DF(T)}$	$V_{ROUT(E)}$		$V_{DF(E)}$		$V_{HYS}$		Vdif1		Vdif2		Isense		
	MIN.	MAX.	MIN.	MAX.	MIN.	MAX.	TYP	MAX	TYP	MAX	MIN	MAX	
14.1	13.818	14.382	13.748	14.453	$V_{DF(E)} \times 1\%$	$V_{DF(E)} \times 7\%$	120	170	350	800	0.6	6.6	
14.2	13.916	14.484	13.845	14.555									
14.3	14.014	14.586	13.943	14.658									
14.4	14.112	14.688	14.040	14.760									
14.5	14.210	14.790	14.138	14.863									
14.6	14.308	14.892	14.235	14.965									
14.7	14.406	14.994	14.333	15.068									
14.8	14.504	15.096	14.430	15.170									
14.9	14.602	15.198	14.528	15.273									
15.0	14.700	15.300	14.625	15.375									
15.1	14.798	15.402	14.723	15.478									
15.2	14.896	15.504	14.820	15.580									
15.3	14.994	15.606	14.918	15.683									
15.4	15.092	15.708	15.015	15.785									
15.5	15.190	15.810	15.113	15.888									
15.6	15.288	15.912	15.210	15.990									
15.7	15.386	16.014	15.308	16.093									
15.8	15.484	16.116	15.405	16.195									
15.9	15.582	16.218	15.503	16.298									
16.0	15.680	16.320	15.600	16.400									
16.1	15.778	16.422						120	170	350	800	0.6	6.6
16.2	15.876	16.524											
16.3	15.974	16.626											
16.4	16.072	16.728											
16.5	16.170	16.830											
16.6	16.268	16.932											
16.7	16.366	17.034											
16.8	16.464	17.136											
16.9	16.562	17.238											
17.0	16.660	17.340											
17.1	16.758	17.442											
17.2	16.856	17.544											
17.3	16.954	17.646											
17.4	17.052	17.748											
17.5	17.150	17.850											
17.6	17.248	17.952											
17.7	17.346	18.054											
17.8	17.444	18.156											
17.9	17.542	18.258											
18.0	17.640	18.360											

## ■ OPERATIONAL EXPLANATION

XC6408 D Series

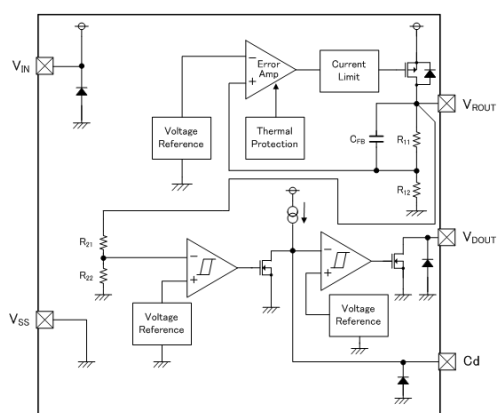

XC6408 E Series

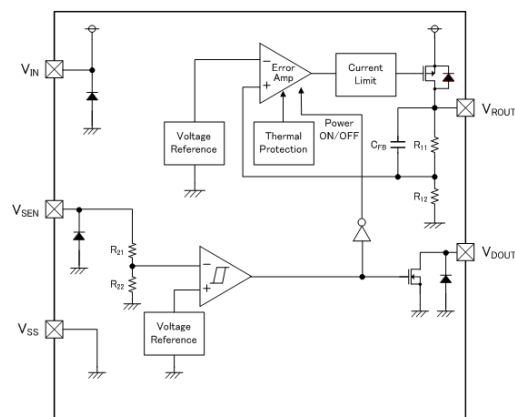

### <Voltage Regulator>

The voltage divided by resistors R11 & R12 is compared with the internal reference voltage by the error amplifier. The P-channel MOSFET which is connected to the  $V_{ROUT}$  pin is then driven by the subsequent output signal. The output voltage at the  $V_{ROUT}$  pin is controlled and stabilized by a system of negative feedback. The current limit circuit, short protect circuit and thermal protection circuit operate in relation to the level of output current and heat generation. For the XC6408E, regulator operation returns active state when  $V_{SEN}$  pin voltage rises higher than the release voltage (\*when  $V_{SEN}$  pin voltage is higher than VD detect voltage + hysteresis width).

### <Limit Current, Short-Circuit Protection>

The XC6408 series includes a current fold-back circuit as a short circuit protection. When the load current reaches the current limit, the current fold-back circuit starts to operate. As a result, the output voltage drops further and output current decreases. When the  $V_{ROUT}$  pin is short-circuited, a flow current minimizes to around 30mA.

### <Thermal Protection>

When the junction temperature of the built-in driver transistor reaches the temperature limit, the thermal shutdown circuit operates and the driver transistor will be set to OFF. The IC resumes its operation when the thermal shutdown function is released and the IC's operation is automatically restored because the junction temperature drops to the level of the thermal shutdown release voltage.

### <Minimum Operating Voltage>

For the stable operation of the IC, over 2.0V of input voltage is necessary. The output voltage may not be generated normally if the input voltage is less than 2.0V.

## OPERATIONAL EXPLANATION (Continued)

### <Voltage detector>

The detector function of the XC6408 series has hysteresis, and when the VD detected voltage rises higher than the release voltage (about 105% (TYP.) of the detect voltage), the output of the  $V_{DOUT}$  pin inverts.

### (D series)

The detector function of the XC6408D series is connected to the  $V_{ROUT}$  pin inside the IC and detects the  $V_{ROUT}$  output voltage.

The voltage divided by the detector's internal resistance which is connected to the  $V_{ROUT}$  pin is compared to the IC internal reference voltage, and if the voltage of the  $V_{ROUT}$  pin falls below the threshold value, low level signal is output from  $V_{DOUT}$ .

A capacitor ( $C_d$ ) can be connected to the  $C_d$  pin to add a delay time to the output signal of the  $V_{DOUT}$  pin at voltage release. The delay time is determined by the constant current value determined by the internal current generator circuit, and the  $C_d$  capacitance value. The relationship between the  $C_d$  capacitance value and the release delay time is shown below.

### (E series)

The detector function of the XC6408E series detects the  $V_{SEN}$  pin voltage.

The voltage divided by the detector internal resistance that is connected to the  $V_{SEN}$  pin is compared to the IC internal reference voltage, and if the voltage of the  $V_{SEN}$  pin falls below the threshold value, low level signal is output from  $V_{DOUT}$ .

● Release Delay Time vs.  $C_d$  connected Capacitance  
XC6408D series

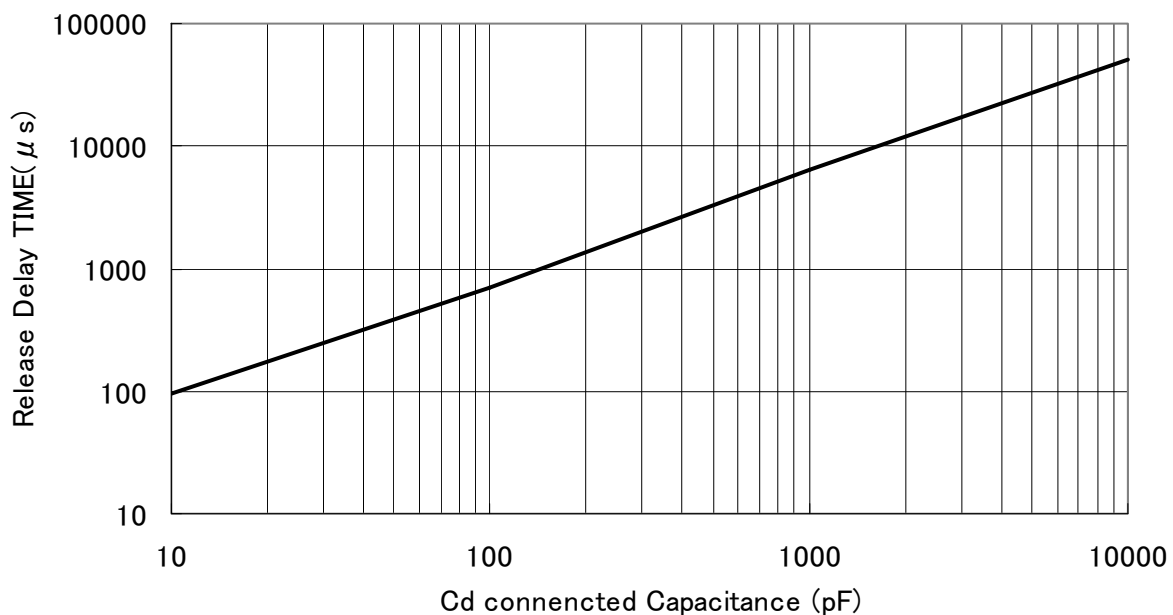

## ■ NOTES ON USE

1. Please use this IC within the stated maximum ratings. For temporary, transitional voltage drop or voltage rising phenomenon, the IC is liable to malfunction should the ratings be exceeded.
2. The power input pin voltage will falls down because of a resistance between power supply and power input pin and shoot through current when IC operates. At this time, if the power input pin voltage is lower than operating voltage range, the IC may cause device malfunction.
3. Please note if the power input pin voltage will fluctuated, the IC may cause device malfunction.
4. If assumed the power input pin voltage falls suddenly (e.g. falls from 28.0V to 0V) at release operation when VD delay capacitor pin is connected to a capacitor, please connect a schottky barrier diode between the power input pin and delay capacitance pin. Please refer below; (XC6408D).
5. The  $V_{DOUT}$  output is configured as N-ch open drain, so please use a pull-up resistance more than  $100k\Omega$  for connecting to the output pin.  
\* When the pull-up resistor connects to another power supply, high level value will be equal to the voltage which the pull-up resistor is connected.
6. If the input voltage fluctuates more than 1.5V in the speed higher than  $100mV/\mu s$ , the output voltage may fluctuate widely. In this case, one capacitor should be added between  $V_{IN}$ - $V_{SS}$  to adjust the input fluctuation speed less than  $100mV/\mu s$ .
7. For a delay capacitor pin of the XC6408D is designed in high impedance. When this pin is left open for use, the IC may get noise. It is recommended that a capacitor more than 3pF is connected to the delay capacitor pin.
8. Phase compensation is performed in the XC6408 inside. Therefore, an abnormal oscillation does not occur even if there is no output capacitor  $C_L$ . An input capacitor  $C_{IN}$  around  $0.1\mu F \sim 1.0\mu F$  between the  $V_{IN}$  pin and the  $V_{SS}$  pin is required for input stability. Also, the output voltage fluctuation such as under shoot or over shoot, which occurs because of the load change can be controlled by placing the output capacitor  $C_L$  around  $0.1\mu F \sim 1.0\mu F$  between the  $V_{ROUT}$  pin and  $V_{SS}$  pin. The input capacitor ( $C_{IN}$ ) and the output capacitor ( $C_L$ ) should be placed to the IC as close as possible with a shorter wiring.
9. Torex places an importance on improving our products and its reliability.  
However, by any possibility, we would request user fail-safe design and post-aging treatment on system or equipment.



e.g. A circuit which delay capacitance pin is connected to a schottky barrier diode.

## TEST CIRCUITS

Circuit ①

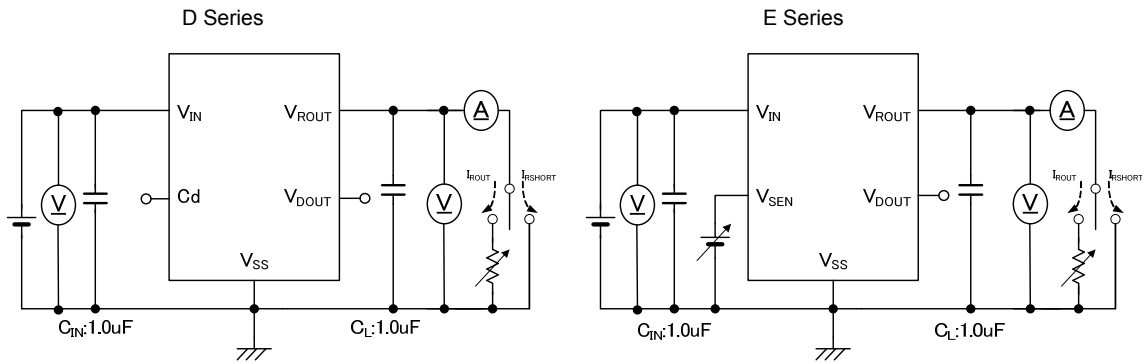

Circuit ②

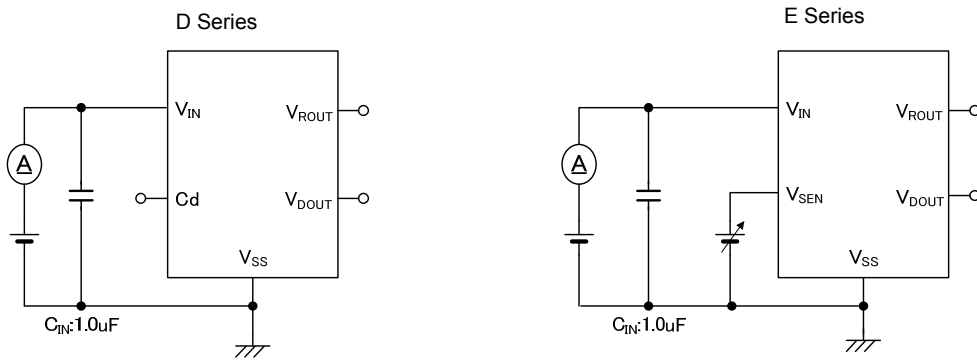





## TYPICAL PERFORMANCE CHARACTERISTICS

### ● XC6408 Series

#### (1) Output Voltage vs. Output Current

XC6408D/E ( $V_{ROUT}=2V$ ,  $V_{IN}=5.0V$ )

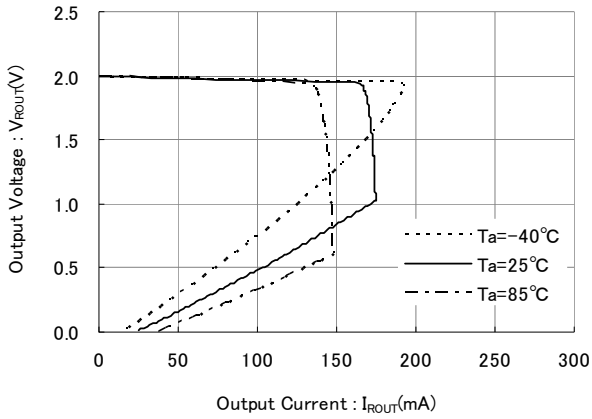

XC6408D/E ( $V_{ROUT}=5.0V$ ,  $V_{IN}=8.0V$ )

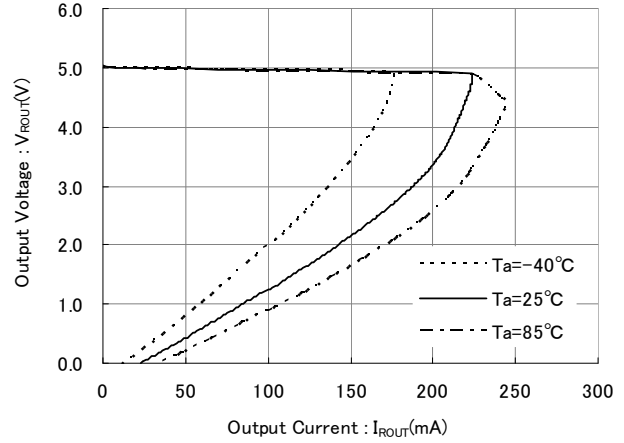

XC6408D/E ( $V_{ROUT}=12.0V$ ,  $V_{IN}=15.0V$ )

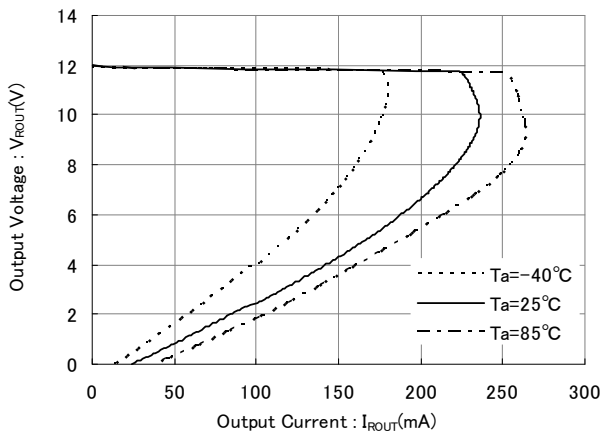

XC6408D/E ( $V_{ROUT}=18.0V$ ,  $V_{IN}=21.0V$ )

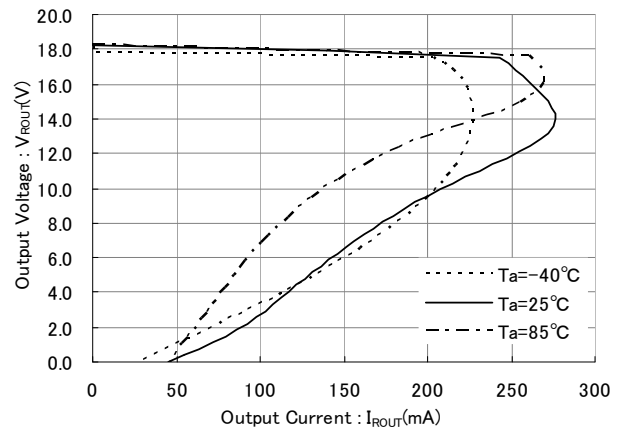

#### (2) Output Voltage vs. Input Voltage

XC6408D/E ( $V_{ROUT}=2.0V$ ,  $I_{ROUT}=5mA$ )

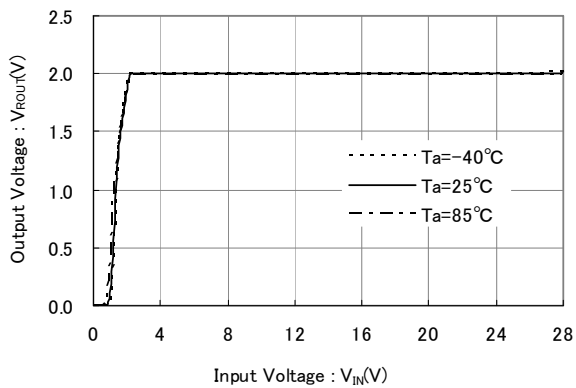

XC6408D/E ( $V_{ROUT}=5.0V$ ,  $I_{ROUT}=5mA$ )

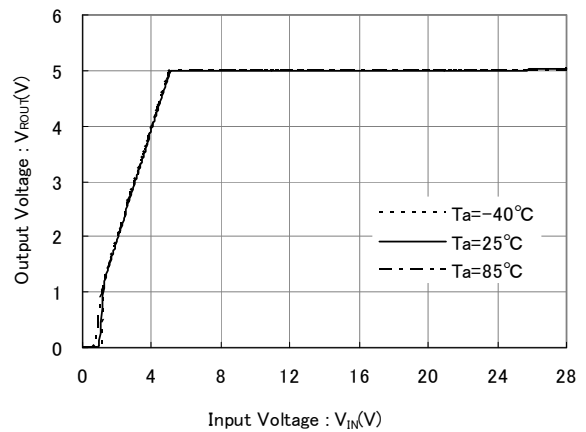

## TYPICAL PERFORMANCE CHARACTERISTICS (Continued)

● XC6408 Series

(2) Output Voltage vs. Input Voltage

XC6408D/E ( $V_{ROUT}=12.0V$ ,  $I_{ROUT}=5mA$ )

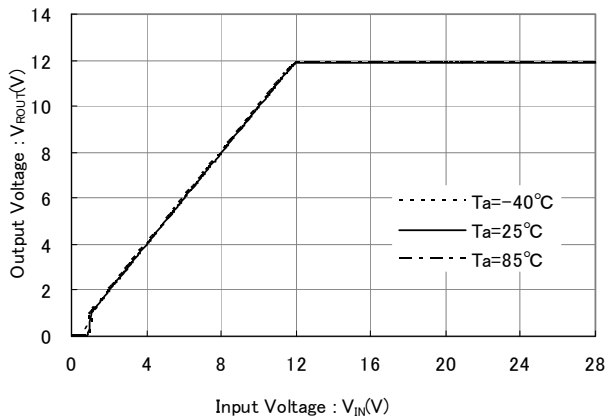

XC6408D/E ( $V_{ROUT}=18.0V$ ,  $I_{ROUT}=5mA$ )

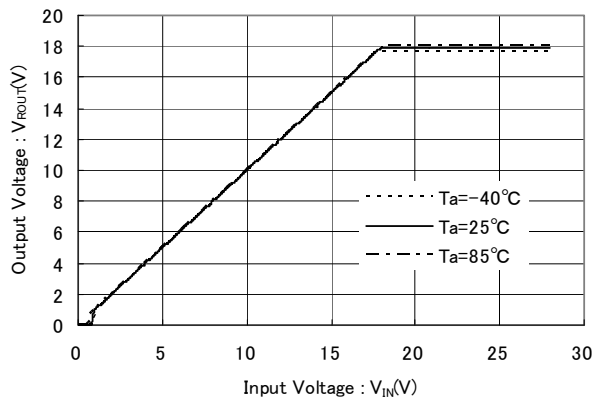

(3) Dropout Voltage vs. Output Current

XC6408D/E ( $V_{ROUT}=2.0V$ )

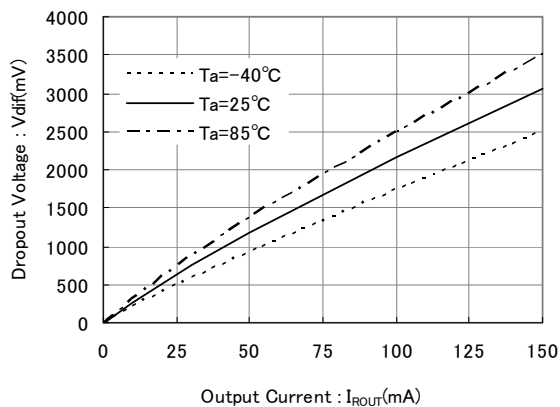

XC6408D/E ( $V_{ROUT}=5.0V$ )

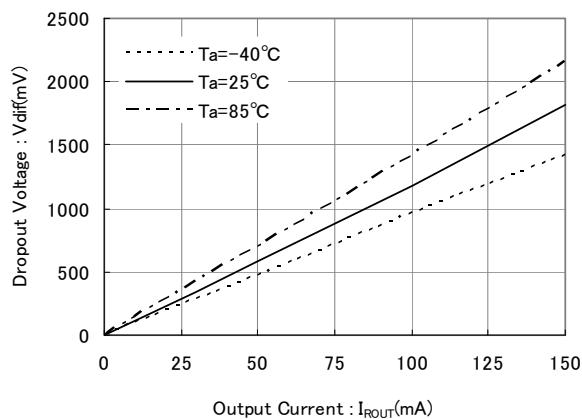

XC6408D/E ( $V_{ROUT}=12.0V$ )

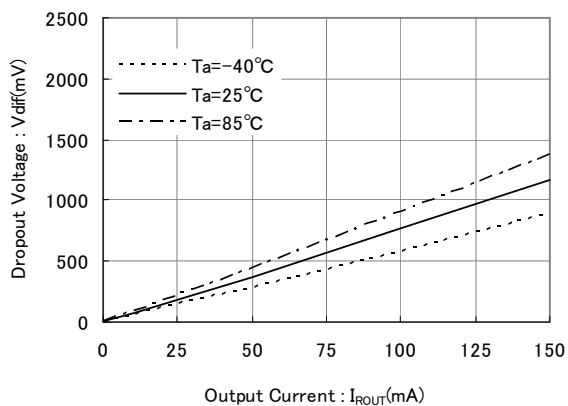

XC6408D/E ( $V_{ROUT}=18.0V$ )

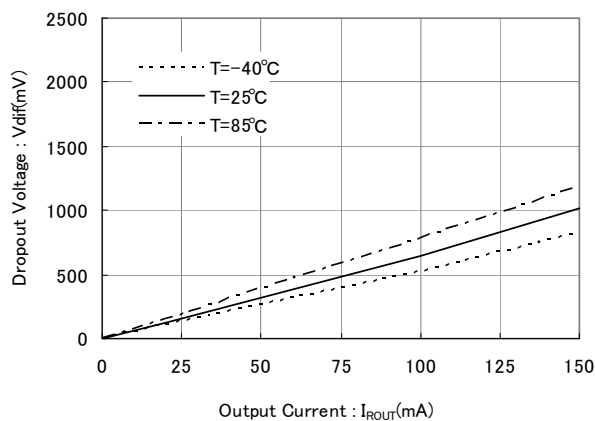

## TYPICAL PERFORMANCE CHARACTERISTICS (Continued)

● XC6408 Series

### (4) Output Voltage vs. Ambient Temperature

XC6408D/E ( $V_{ROUT}=2.0V$ ,  $I_{ROUT}=20mA$ )



XC6408D/E ( $V_{ROUT}=5.0V$ ,  $I_{ROUT}=20mA$ )



XC6408D/E ( $V_{ROUT}=12.0V$ ,  $I_{ROUT}=20mA$ )

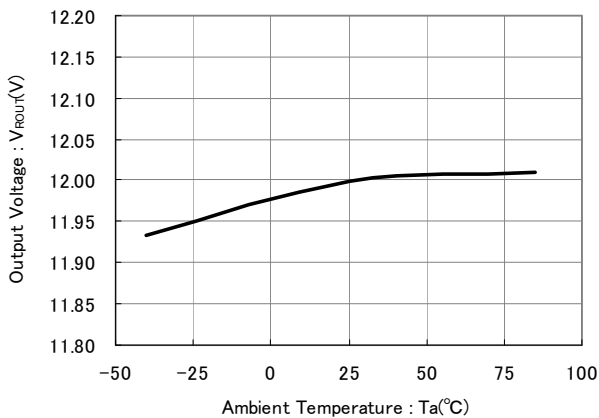

XC6408D/E ( $V_{ROUT}=18.0V$ ,  $I_{ROUT}=20mA$ )

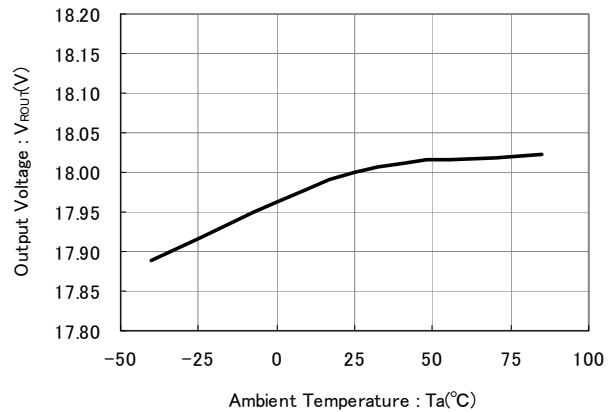

### (5) Ripple Rejection Ratio

XC6408D/E ( $V_{ROUT}=2.0V$ ,  $V_{IN}=4.0V_{DC}+0.5V_{P-PAC}$ )  
( $C_L=1.0\mu F$ (Ceramic),  $T_a=25^\circ C$ )



XC6408D/E ( $V_{ROUT}=5.0V$ ,  $V_{IN}=7.0V_{DC}+0.5V_{P-PAC}$ )  
( $C_L=1.0\mu F$ (Ceramic),  $T_a=25^\circ C$ )

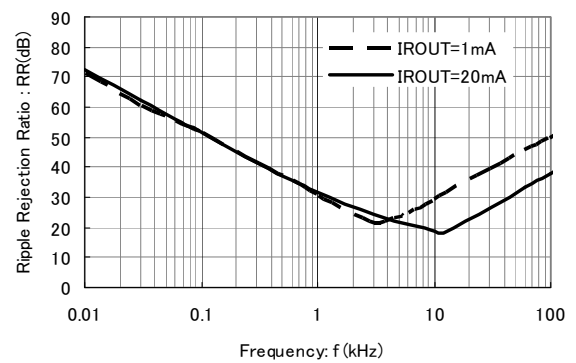

## TYPICAL PERFORMANCE CHARACTERISTICS (Continued)

● XC6408 Series

(5) Ripple Rejection Ratio (Continued)

XC6408D/E ( $V_{ROUT}=12.0V$ ,  $V_{IN}=14.0V_{DC}+0.5V_{p-pAC}$ )  
( $C_L=1.0\mu F$ (Ceramic),  $T_a=25^\circ C$ )

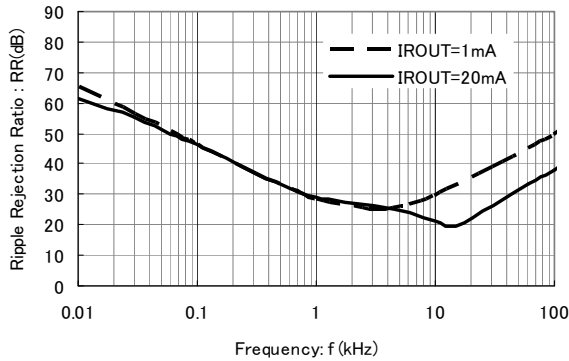

XC6408D/E ( $V_{ROUT}=18.0V$ ,  $V_{IN}=20.0V_{DC}+0.5V_{p-pAC}$ )  
( $C_L=1.0\mu F$ (Ceramic),  $T_a=25^\circ C$ )

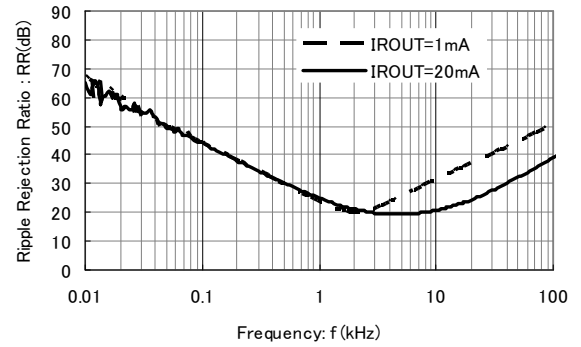

(6) Line Transient Response

XC6408D/E ( $V_{ROUT}=2.0V$ ,  $I_{ROUT}=30mA$ ,  $tr=tf=5\mu s$ )  
( $C_L=1\mu F$ (ceramic),  $T_a=25^\circ C$ )

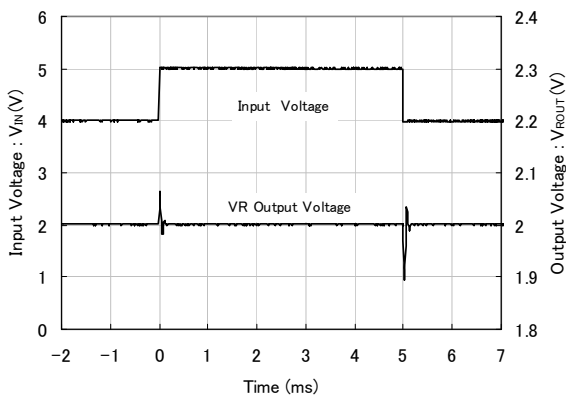

XC6408D/E ( $V_{ROUT}=5.0V$ ,  $I_{ROUT}=30mA$ ,  $tr=tf=5\mu s$ )  
( $C_L=1\mu F$ (ceramic),  $T_a=25^\circ C$ )

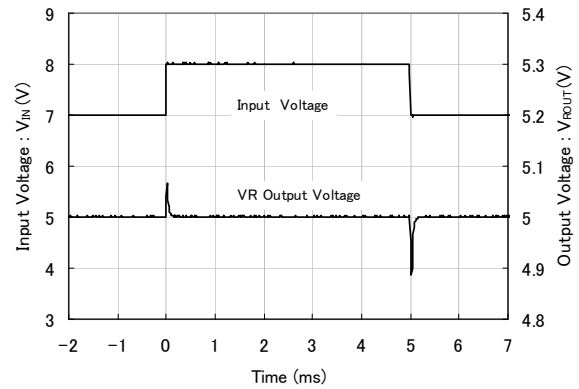

XC6408D/E ( $V_{ROUT}=12.0V$ ,  $I_{ROUT}=30mA$ ,  $tr=tf=5\mu s$ )  
( $C_L=1\mu F$ (ceramic),  $T_a=25^\circ C$ )

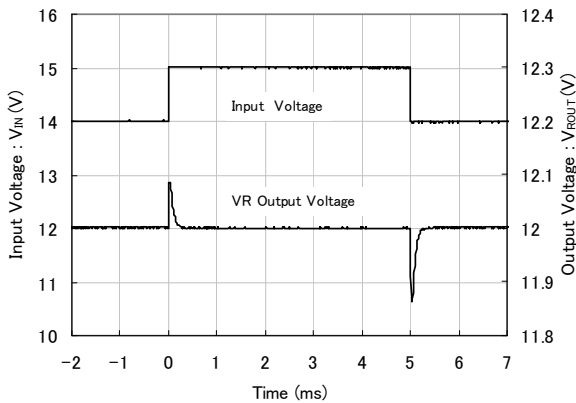

XC6408D/E ( $V_{ROUT}=18.0V$ ,  $I_{ROUT}=30mA$ ,  $tr=tf=5\mu s$ )  
( $C_L=1\mu F$ (ceramic),  $T_a=25^\circ C$ )

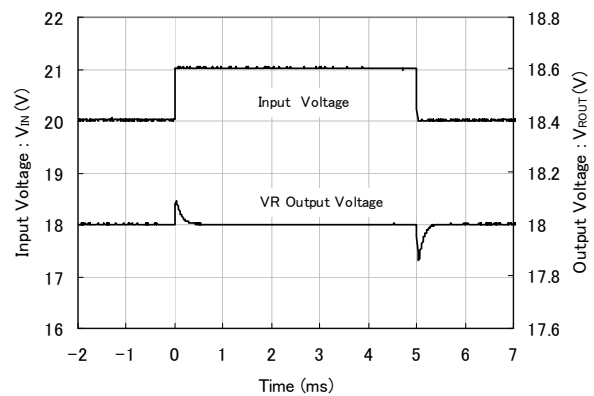

## TYPICAL PERFORMANCE CHARACTERISTICS (Continued)

- XC6408 Series

### (7) Load Transient Response

XC6408D/E ( $V_{ROUT}=2.0V$ ,  $V_{IN}=5.0V$ ,  $tr=tf=5\mu s$ )  
( $C_{IN}=C_L=1\mu F$ (ceramic),  $T_a=25^\circ C$ )

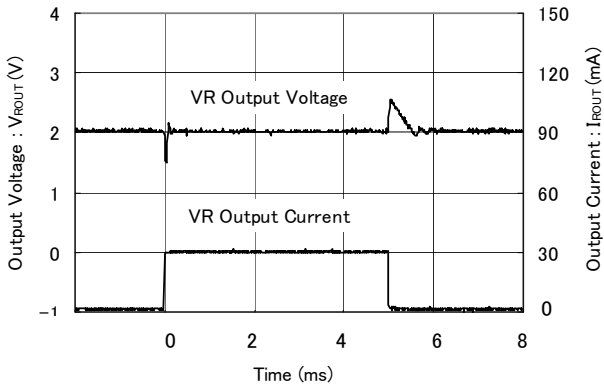

XC6408D/E ( $V_{ROUT}=5.0V$ ,  $V_{IN}=7.0V$ ,  $tr=tf=5\mu s$ )  
( $C_{IN}=C_L=1\mu F$ (ceramic),  $T_a=25^\circ C$ )



XC6408D/E ( $V_{ROUT}=12.0V$ ,  $V_{IN}=14.0V$ ,  $tr=tf=5\mu s$ )  
( $C_{IN}=C_L=1\mu F$ (ceramic),  $T_a=25^\circ C$ )



XC6408D/E ( $V_{ROUT}=18.0V$ ,  $V_{IN}=20.0V$ ,  $tr=tf=5\mu s$ )  
( $C_{IN}=C_L=1\mu F$ (ceramic),  $T_a=25^\circ C$ )



## TYPICAL PERFORMANCE CHARACTERISTICS (Continued)

● XC6408D Series

(8) Supply Current vs. Input Voltage

XC6408D ( $V_{ROUT}=2.0V$ ,  $V_{DF}=2.0V$ )



XC6408D ( $V_{ROUT}=5.0V$ ,  $V_{DF}=4.5V$ )

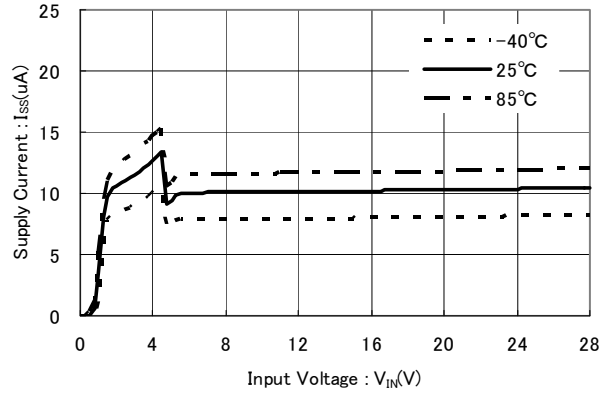

XC6408D ( $V_{ROUT}=12.0V$ ,  $V_{DF}=11.0V$ )



XC6408D ( $V_{ROUT}=18.0V$ ,  $V_{DF}=16.0V$ )

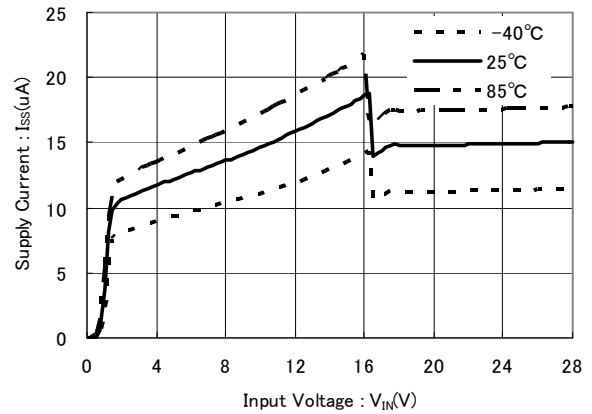

## TYPICAL PERFORMANCE CHARACTERISTICS (Continued)

### ● XC6408E Series

#### (8) Supply Current vs. Input Voltage (Continued)

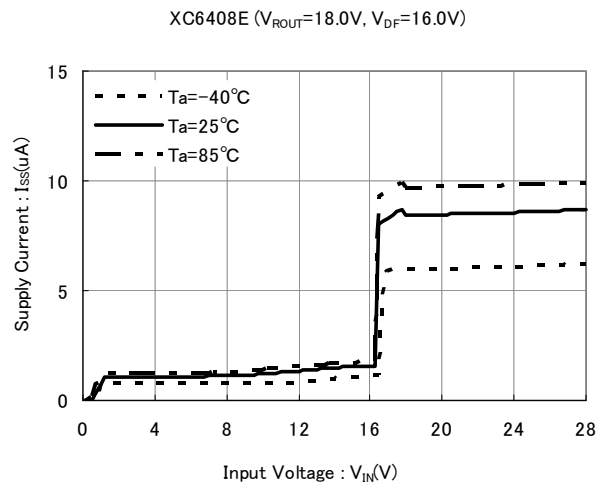
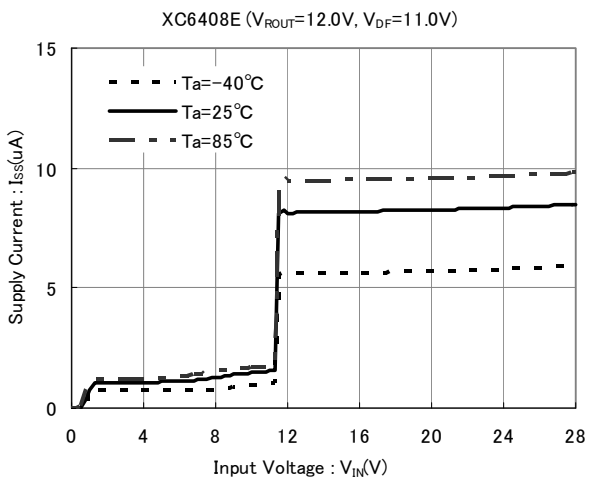
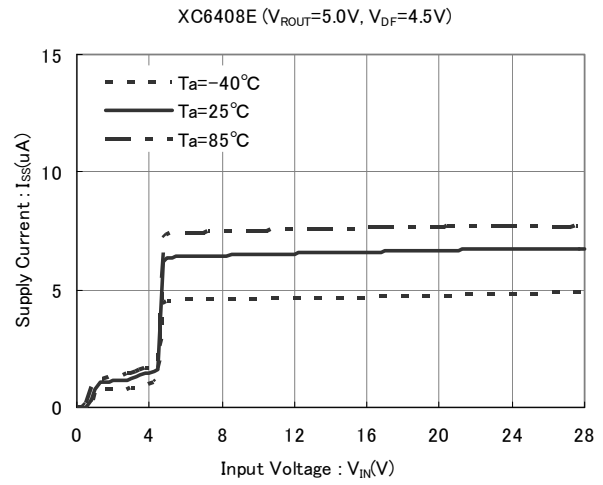
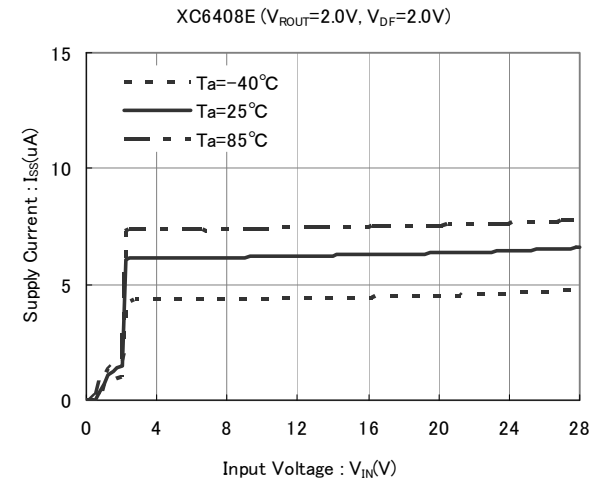



## ■ TYPICAL PERFORMANCE CHARACTERISTICS (Continued)

● XC6408E Series

(9) SENSE Current vs. SENSE Voltage

XC6408E ( $V_{DF}=2.0V$ )

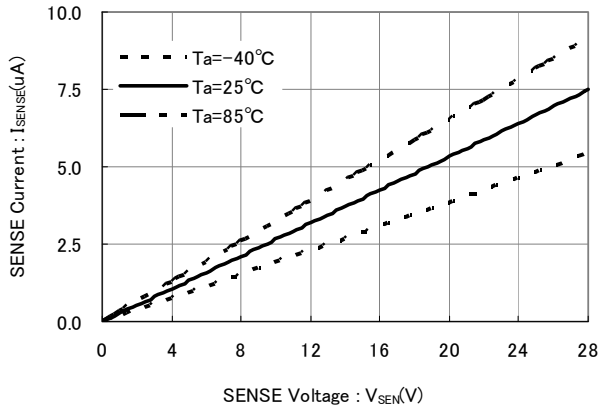

XC6408E ( $V_{DF}=4.5V$ )



XC6408E ( $V_{DF}=11.0V$ )

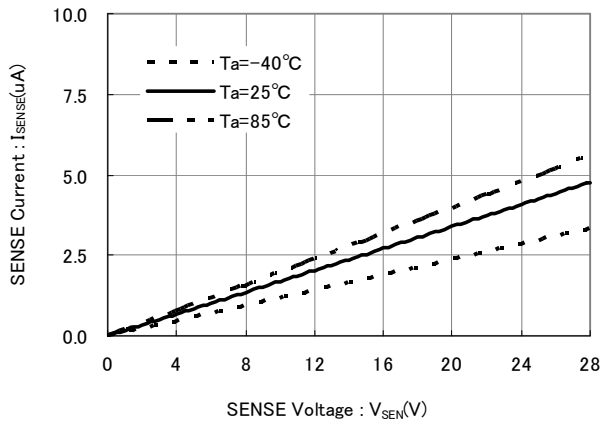

XC6408E ( $V_{DF}=16.0V$ )

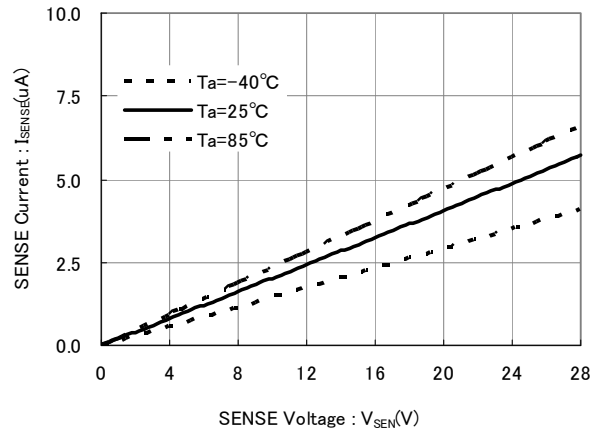

## TYPICAL PERFORMANCE CHARACTERISTICS (Continued)

### ● XC6408E Series

(10) VD Supply Current vs. Input Voltage

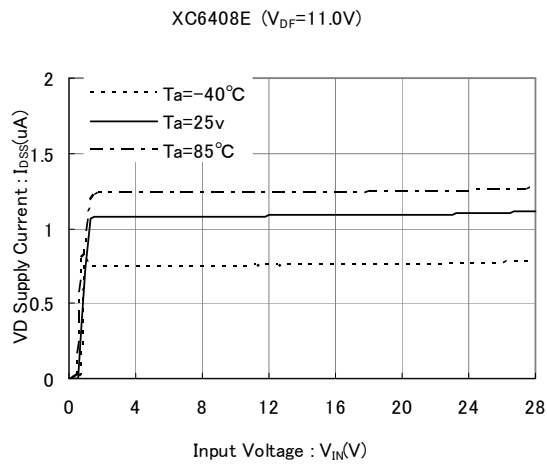
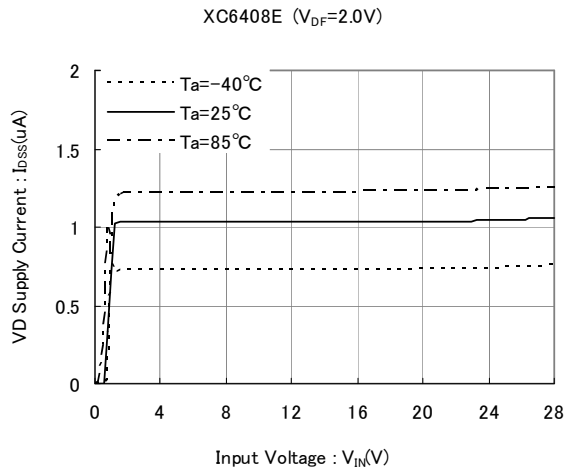

### ● XC6408D Series

(11) Cd Pin Current



### ● XC6408 Series

(12) VD N-ch Driver Output Current vs. N-ch Driver  $V_{DS}$

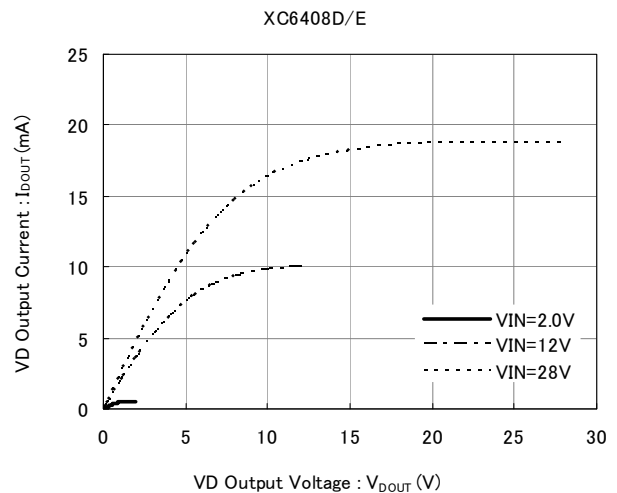

## TYPICAL PERFORMANCE CHARACTERISTICS (Continued)

● XC6408 Series

(13) VD N-ch Driver Output Current vs. Input Voltage



(14) Detect Voltage vs. Ambient Temperature  
Release Voltage vs. Ambient Temperature

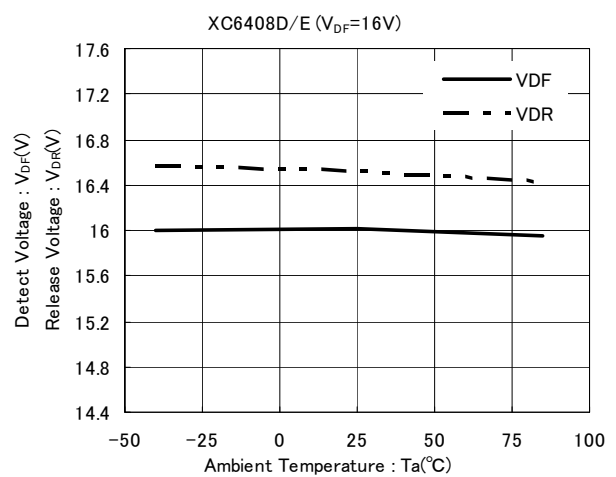
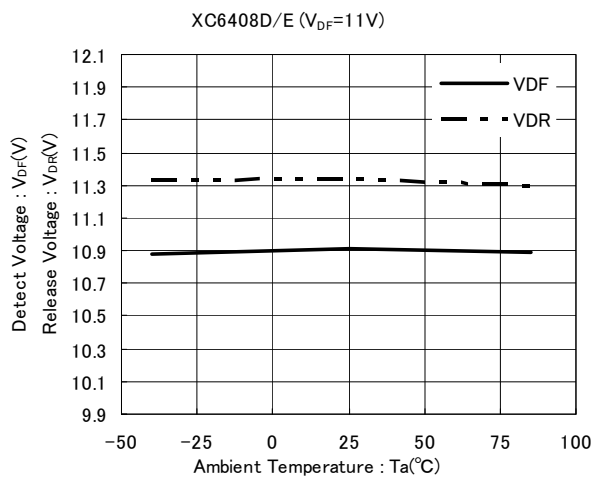
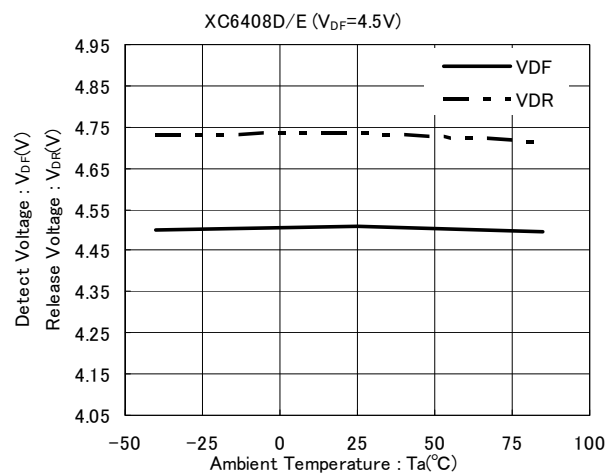

## PACKAGING INFORMATION

### ● USP-6C

(unit : mm)



### ● SOT-25

(unit : mm)

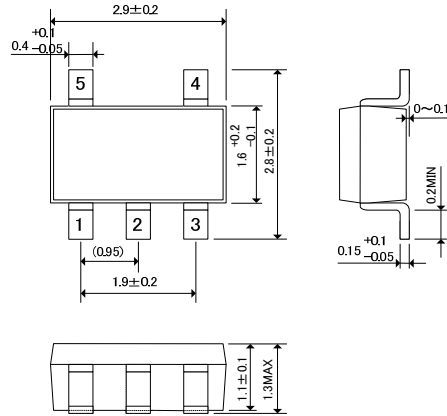

### ● SOT-89-5

(unit : mm)

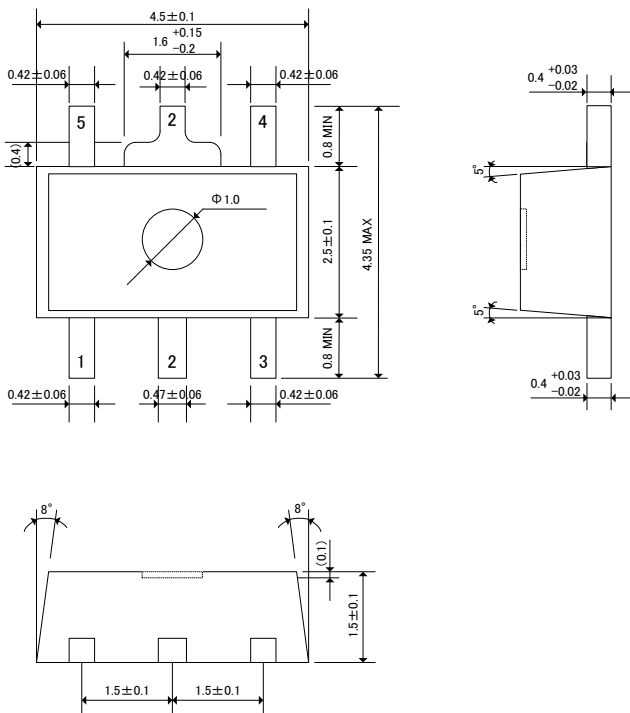

**PACKAGING INFORMATION (Continued)**

●USP-6C Reference Pattern Layout

●USP-6C Reference Metal Mask Design

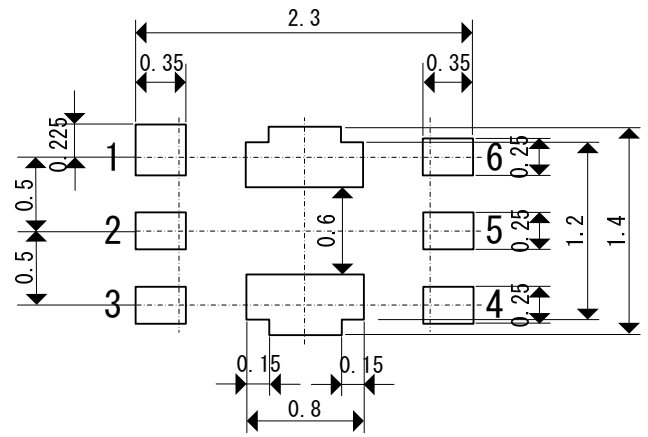
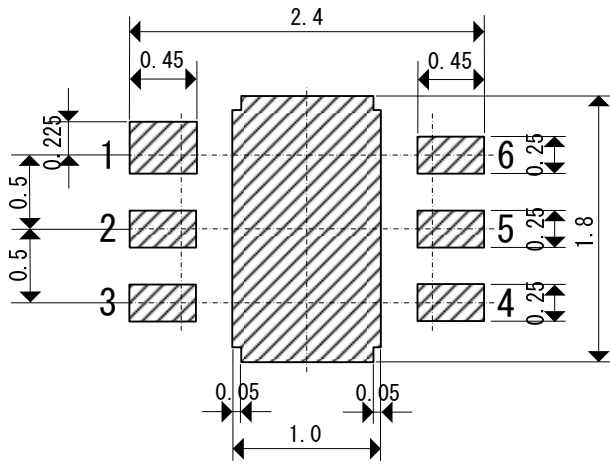

## PACKAGING INFORMATION (Continued)

### ● USP-6C Power Dissipation

Power dissipation data for the USP-6C is shown in this page.

The value of power dissipation varies with the mount board conditions.

Please use this data as one of reference data taken in the described condition.

#### 1. Measurement Condition (Reference data)

- Condition: Mount on a board
- Ambient: Natural convection
- Soldering: Lead (Pb) free
- Board: Dimensions 40 x 40 mm (1600 mm<sup>2</sup> in one side)  
Copper (Cu) traces occupy 50% of the board area  
In top and back faces  
Package heat-sink is tied to the copper traces
- Material: Glass Epoxy (FR-4)
- Thickness: 1.6 mm
- Through-hole: 4 x 0.8 Diameter

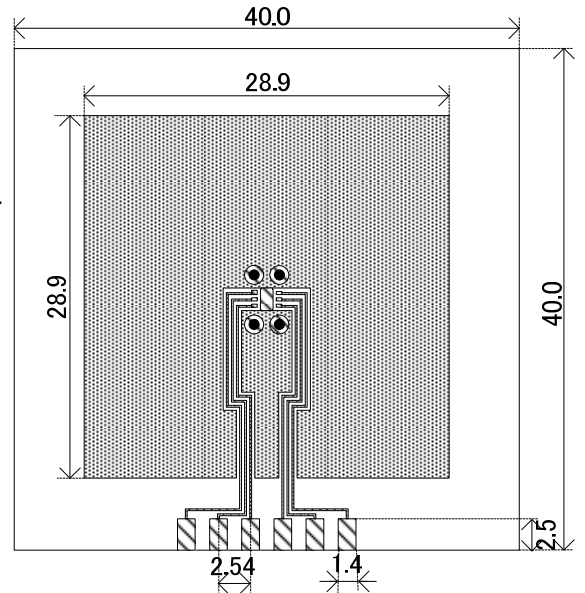

Evaluation Board (Unit: mm)

#### 2. Power Dissipation vs. Ambient temperature

Board Mount ( $T_j \text{ max} = 125^\circ\text{C}$ )

Ambient Temperature ( $^\circ\text{C}$ )	Power Dissipation Pd (mW)	Thermal Resistance ( $^\circ\text{C}/\text{W}$ )
25	1000	100.00
85	400	

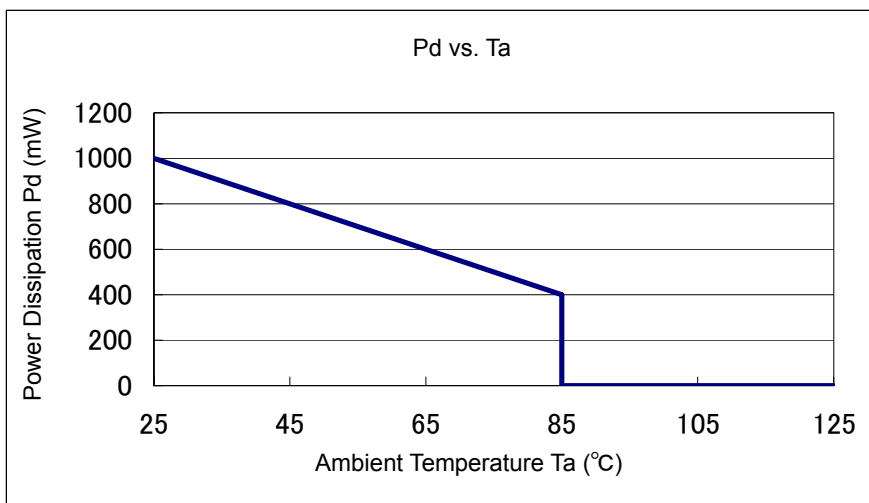

## ■ PACKAGING INFORMATION (Continued)

### ● SOT-25 Power Dissipation

Power dissipation data for the SOT-25 is shown in this page.

The value of power dissipation varies with the mount board conditions.

Please use this data as one of reference data taken in the described condition.

#### 1. Measurement Condition (Reference data)

- Condition: Mount on a board
- Ambient: Natural convection
- Soldering: Lead (Pb) free
- Board: Dimensions 40 x 40 mm (1600 mm<sup>2</sup> in one side)  
Copper (Cu) traces occupy 50% of the board area  
In top and back faces  
Package heat-sink is tied to the copper traces  
(Board of SOT-26 is used.)
- Material: Glass Epoxy (FR-4)
- Thickness: 1.6 mm
- Through-hole: 4 x 0.8 Diameter

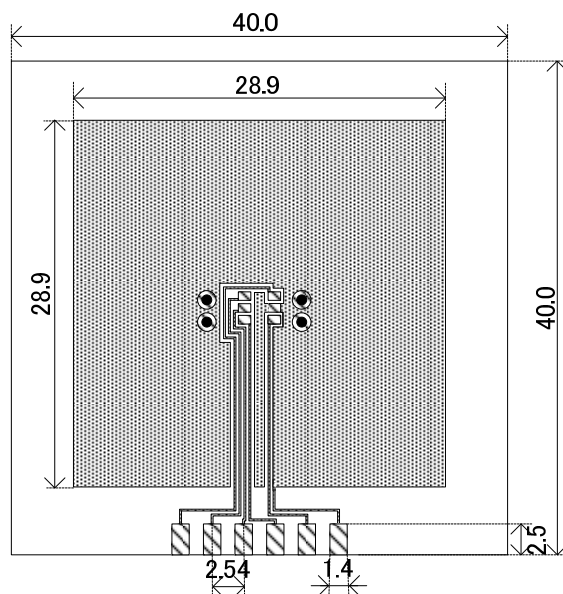

Evaluation Board (Unit: mm)

#### 2. Power Dissipation vs. Ambient temperature

Board Mount ( $T_j \text{ max} = 125^\circ\text{C}$ )

Ambient Temperature ( $^\circ\text{C}$ )	Power Dissipation $P_d$ (mW)	Thermal Resistance ( $^\circ\text{C}/\text{W}$ )
25	600	166.67
85	240	

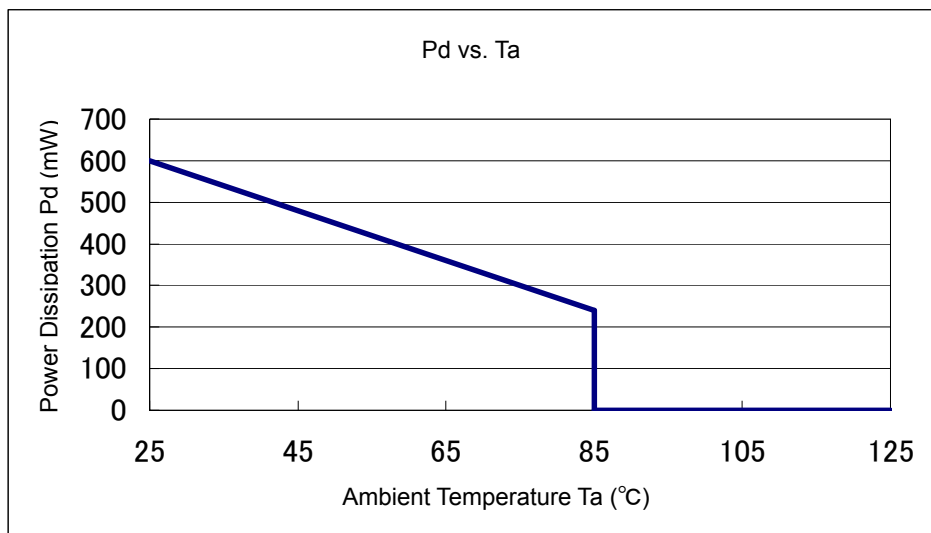

## PACKAGING INFORMATION (Continued)

### SOT-89-5 Power Dissipation

Power dissipation data for the SOT-89-5 is shown in this page.  
 The value of power dissipation varies with the mount board conditions.  
 Please use this data as one of reference data taken in the described condition.

#### 1. Measurement Condition (Reference data)

- Condition: Mount on a board
- Ambient: Natural convection
- Soldering: Lead (Pb) free
- Board: Dimensions 40 x 40 mm (1600 mm<sup>2</sup> in one side)  
 Copper (Cu) traces occupy 50% of the board area  
 In top and back faces  
 Package heat-sink is tied to the copper traces
- Material: Glass Epoxy (FR-4)
- Thickness: 1.6 mm
- Through-hole: 5 x 0.8 Diameter

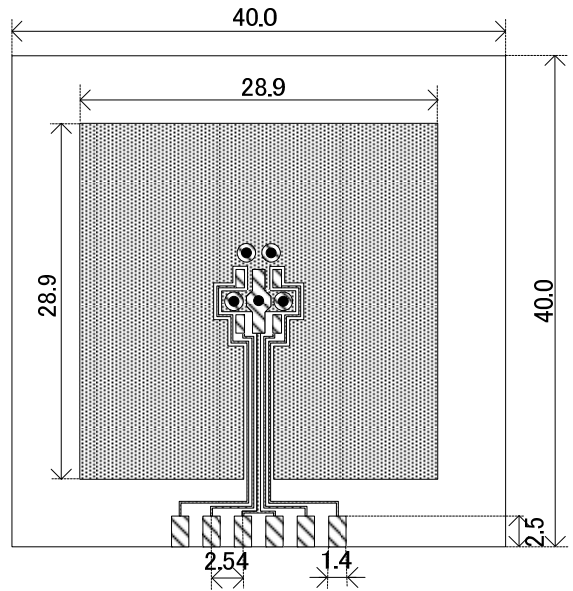

Evaluation Board (Unit: mm)

#### 2. Power Dissipation vs. Ambient temperature

Board Mount ( $T_j \text{ max} = 125^\circ\text{C}$ )

Ambient Temperature (°C)	Power Dissipation Pd (mW)	Thermal Resistance (°C/W)
25	1300	76.92
85	520	

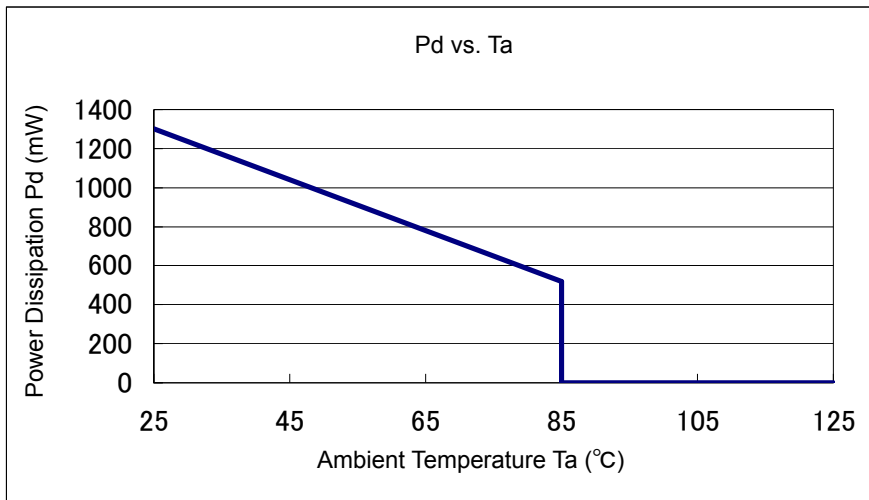



## ■ MARKING RULE

● SOT-25, SOT-89-5, USP-6C

① represents additional function.

MARK	PRODUCT SERIES
D	XC6408D****-G
E	XC6408E****-G

②③ represents combination of output voltage and detect voltage for each IC.  
Numbers are sequence.

MARK	PRODUCT SERIES
01	XC6408**01**-G

④⑤ represents production lot number.  
01 to 09, 0A to 0Z, 11 to 9Z, A1 to A9, AA to Z9, ZA to ZZ in order.

(G, I, J, O, Q, W excepted)

\*No character inversion used.

SOT25



SOT89-5

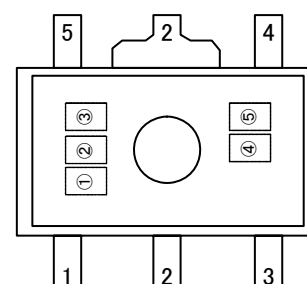

USP6C

