

0.8 μ A Low Power Consumption Dual Voltage Regulator

■ GENERAL DESCRIPTION

The XC6411P/XC6412B series is a dual LDO regulator manufactured using CMOS process. The series achieves very low supply current 0.8 μ A typical by channel and consists of a reference voltage source, an error amplifier, a current foldback circuit, and a phase compensation circuit plus a driver transistor. The XC6411P series in SOT-25 packages, the XC6412B series in SOT-26 packages make high density mounting possible. Therefore, the series is ideally suited for applications where high density mounting is required such as mobile equipment.

Each output voltage of two regulators VR1 and VR2 is selectable in 0.1V increments within a range of 0.9V to 5.0V by laser trimming. The series is compatible with low ESR ceramic capacitors, which provides stable outputs. The VR1 and VR2 are completely isolated so that a cross talk during load fluctuation is minimized. The current limiter's foldback circuit also operates as a short protection for the output pin.

■ APPLICATIONS

- Digital audio equipment
- Smart phones / Mobile phones
- Portable games
- Digital still cameras / Camcorders
- Mobile devices / terminals

■ FEATURES

- Maximum Output Current** : 200mA (300mA Limit TYP.)
@ $V_{OUT}=3.0V$, $V_{IN}=4.0V$
- Dropout Voltage** : 320mV @ $I_{OUT} = 100mA$
@ $V_{OUT} = 3.0V$
- Input Voltage Range** : 1.5V ~ 6.0V
- Output Voltage Range** : 0.9V ~ 5.0V (0.1V increments)
- Highly Accurate** : $\pm 2\%$ ($1.5V < V_{OUT} \leq 5.0V$)
 $\pm 0.03V$ ($0.9V \leq V_{OUT} \leq 1.5V$)
- Low Power Consumption** : 0.8 μ A / ch.(TYP.)
- Low ESR Capacitor Compatible**: Ceramic capacitor
- Current Limiter Circuit Built-In**
- Operating Ambient Temperature** : - 40°C ~ 85°C
- Small Packages** : SOT-25 (XC6411P)
SOT-26 (XC6412B)
- Environmentally Friendly** : EU RoHS Compliant, Pb Free

■ TYPICAL APPLICATION CIRCUIT

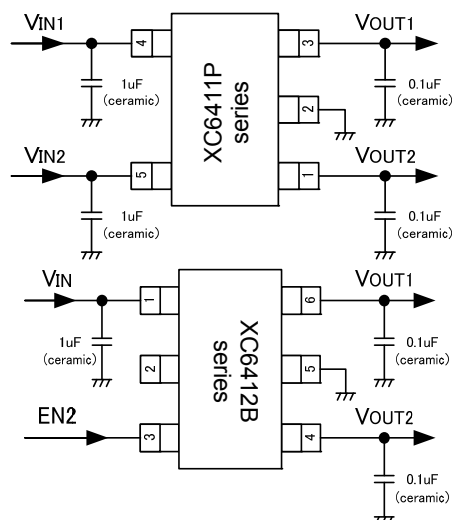

■ TYPICAL PERFORMANCE CHARACTERISTICS

- Supply Current vs. Input Voltage

VR1/VR2: 3.0V

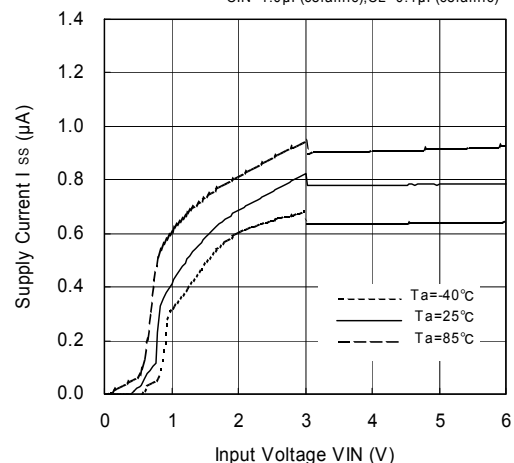
CIN=1.0 μ F(ceramic), CL=0.1 μ F(ceramic)

PIN CONFIGURATION

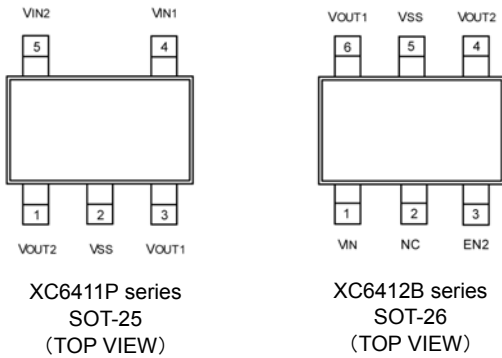

PIN ASSIGNMENT

PIN NUMBER		PIN NAME	FUNCTIONS
XC6411P	XC6412B		
-	1	V_{IN}	Power Input
-	2	NC	No Connection
-	3	EN2	ON / OFF Switch (ch. 2)
1	4	V_{OUT2}	Output 2
2	5	V_{SS}	Ground
3	6	V_{OUT1}	Output 1
4	-	V_{IN1}	Power Input 1
5	-	V_{IN2}	Power Input 2

* When using an SOT-26 package for the XC6412B series, please note that No. 1 pin is common input voltage.

FUNCTION CHART

XC6412B Series

EN2	VR1 OPERATION	VR2 OPERATION
"H" Level	ON	ON
"L" Level		Undefined state

*VR1 does not have EN function.

PRODUCT CLASSIFICATION

Ordering Information

XC6411P①②③④⑤-⑥

XC6412B①②③④⑤-⑥

DESIGNATOR	ITEM	SYMBOL	DESCRIPTION
①②③	Output Voltage	001~	Serial number for VR1 and VR2 voltage combination Factory set range: 0.9~5.0V (0.1V increments)
④⑤-⑥ ^(*)	Packages (Order Unit)	MR	SOT-25 (XC6411P) (3,000/Reel)
		MR-G	SOT-25 (XC6411P) (3,000/Reel)
		MR	SOT-26 (XC6412B) (3,000/Reel)
		MR-G	SOT-26 (XC6412B) (3,000/Reel)

(*) The "-G" suffix denotes Halogen and Antimony free as well as being fully EU RoHS compliant.

■ BLOCK DIAGRAMS

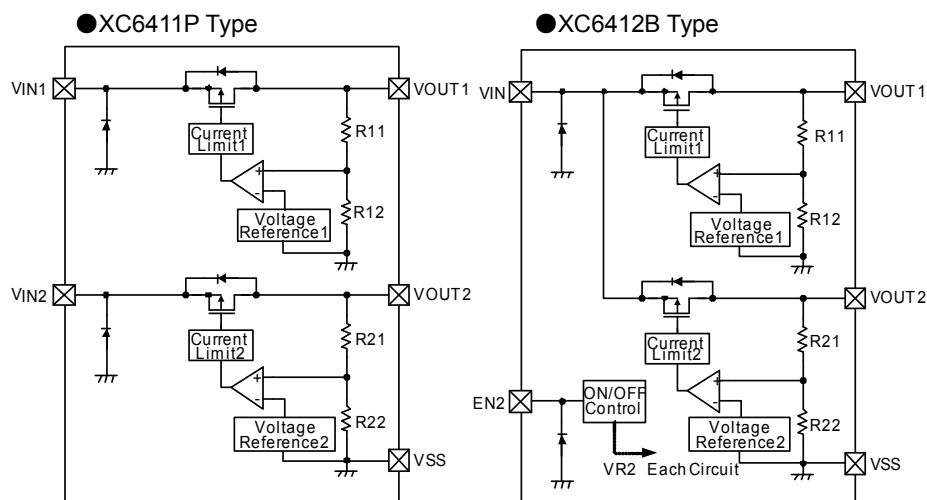

* Diodes shown in the above circuit are ESD protection diodes and parasitic diodes.

■ ABSOLUTE MAXIMUM RATINGS

Ta = 25°C

PARAMETER	SYMBOL	RATINGS	UNITS
Input Voltage	V _{IN}	- 0.3 ~ + 7.0	V
Input Voltage 1	V _{IN1}	- 0.3 ~ + 7.0	V
Input Voltage 2	V _{IN2}	- 0.3 ~ + 7.0	V
Output Current 1	I _{OUT1}	500 (*1)	mA
Output Current 2	I _{OUT2}	500 (*1)	mA
Output Voltage 1	V _{OUT1}	V _{SS} - 0.3 ~ V _{IN} + 0.3	V
Output Voltage 2	V _{OUT2}	V _{SS} - 0.3 ~ V _{IN} + 0.3	V
EN2 Pin Voltage	V _{EN2}	V _{SS} - 0.3 ~ 0.7	V
Power Dissipation	SOT-25	Pd	250
	SOT-26		
Operating Ambient Temperature	T _{opr}	- 40 ~ + 85	°C
Storage Temperature	T _{stg}	- 55 ~ +125	°C

All voltages are described based on the V_{SS} pin.

Note: *1: Please use the XC6411P (SOT-25) series with following to the equation;

$$Pd > [(V_{IN1} - V_{OUT1}) \times I_{OUT1} + (V_{IN2} - V_{OUT2}) \times I_{OUT2}]$$

Please use the XC6412B (SOT-26) series with following to the equation;

$$Pd > [(V_{IN} - V_{OUT1}) \times I_{OUT1} + (V_{IN} - V_{OUT2}) \times I_{OUT2}]$$

ELECTRICAL CHARACTERISTICS

XC6411P/XC6412B, Regulator 1 and Regulator 2

Ta = 25°C

PARAMETER	SYMBOL	CONDITIONS	MIN.	TYP.	MAX.	UNITS	CIRCUIT
Output Voltage	$V_{OUT(E)}^{(*2)}$	$V_{IN}=V_{EN2}=V_{OUT(T)}^{(*1)}+1.0V$ $I_{OUT}=1mA$	E-0 ^(*4)			V	①
Maximum Output Current	I_{OUTMAX}	$V_{IN}=V_{EN2}=V_{OUT(T)}+1.0V$ $V_{OUT(T)}=0.9V$	50	70	-	mA	①
		$V_{IN}=V_{EN2}=V_{OUT(T)}+1.0V$ $V_{OUT(T)}=1.0V \sim 1.1V$	60	80	-		
		$V_{IN}=V_{EN2}=V_{OUT(T)}+1.0V$ $V_{OUT(T)}=1.2V \sim 1.3V$	80	110	-		
		$V_{IN}=V_{EN2}=V_{OUT(T)}+1.0V$ $V_{OUT(T)}=1.4V \sim 1.6V$	100	140	-		
		$V_{IN}=V_{EN2}=V_{OUT(T)}+1.0V$ $V_{OUT(T)}=1.7V \sim 2.2V$	120	150	-		
		$V_{IN}=V_{EN2}=V_{OUT(T)}+1.0V$ $V_{OUT(T)}=2.3V \sim 2.9V$	150	195	-		
		$V_{IN}=V_{EN2}=V_{OUT(T)}+1.0V$ $V_{OUT(T)} \geq 3.0V$	200	300	-		
Load Regulation	ΔV_{OUT}	$V_{IN}=V_{EN2}=V_{OUT(T)}+1.0V$ $V_{OUT(T)}=0.9V$ $1mA \leq I_{OUT} \leq 50mA$	-	15	70	mV	①
		$V_{IN}=V_{EN2}=V_{OUT(T)}+1.0V$ $V_{OUT(T)}=1.0V \sim 1.1V$ $1mA \leq I_{OUT} \leq 60mA$					
		$V_{IN}=V_{EN2}=V_{OUT(T)}+1.0V$ $V_{OUT(T)}=1.2V \sim 1.3V$ $1mA \leq I_{OUT} \leq 80mA$					
		$V_{IN}=V_{EN2}=V_{OUT(T)}+1.0V$ $V_{OUT(T)} \geq 1.4V$ $1mA \leq I_{OUT} \leq 100mA$					
Dropout Voltage	$V_{dif}^{(*3)}$	$V_{EN2}=V_{IN}$ $V_{OUT(T)}=0.9V$ $I_{OUT}=50mA$	E-1 ^(*4)			mV	①
		$V_{EN2}=V_{IN}$ $V_{OUT(T)}=1.0V \sim 1.1V$ $I_{OUT}=60mA$					
		$V_{EN2}=V_{IN}$ $V_{OUT(T)}=1.2V \sim 1.3V$ $I_{OUT}=80mA$					
		$V_{EN2}=V_{IN}$ $V_{OUT(T)} \geq 1.4V$ $I_{OUT}=100mA$					
Line Regulation	$\frac{\Delta V_{OUT}}{(\Delta V_{IN} \cdot V_{OUT})}$	$V_{OUT(T)}+0.5V \leq V_{IN} \leq 6.0V$ ($0.9V \leq V_{IN} \leq 6.0V$) $V_{EN2}=V_{IN}$	-	0.05	0.15	%V	①
		$V_{OUT(T)} \leq 1.2V$ $I_{OUT}=1mA$					
		$V_{OUT(T)} \geq 1.3V$ $I_{OUT}=30mA$					
Input Voltage	V_{IN}	1.5	-	6.0	V	-	
Output Voltage Temperature Characteristics	$\frac{\Delta V_{OUT}}{(\Delta T_{opr} \cdot V_{OUT})}$	$V_{IN}=V_{EN2}=V_{OUT(T)}+1.0V$ $I_{OUT}=30mA$ $-40^\circ C \leq T_{opr} \leq 85^\circ C$	-	± 100	-	ppm/°C	①

■ ELECTRICAL CHARACTERISTICS (Continued)

XC6411P/XC6412B Series, Regulator 1 and Regulator 2 (Continued)

Ta = 25°C

PARAMETER	SYMBOL	CONDITIONS	MIN.	TYP.	MAX.	UNITS	CIRCUIT
Current Limit	Ilim	$V_{OUT}=V_{OUT(E)} \times 0.95, V_{OUT(T)}=0.9V$ $V_{IN}=V_{EN2}=V_{OUT(T)}+2.0V$	100	300	-	mA	①
		$V_{OUT}=V_{OUT(E)} \times 0.95, V_{OUT(T)}=1.0V \sim 1.1V$ $V_{IN}=V_{EN2}=V_{OUT(T)}+2.0V$	120	300	-		
		$V_{OUT}=V_{OUT(E)} \times 0.95, V_{OUT(T)}=1.2V \sim 1.3V$ $V_{IN}=V_{EN2}=V_{OUT(T)}+2.0V$	160	300	-		
		$V_{OUT}=V_{OUT(E)} \times 0.95, V_{OUT(T)}=1.4V \sim 2.9V$ $V_{IN}=V_{EN2}=V_{OUT(T)}+2.0V$	200	300	-		
		$V_{OUT}=V_{OUT(E)} \times 0.95, V_{OUT(T)} \geq 3.0V$ $V_{IN}=V_{EN2}=V_{OUT(T)}+1.0V$	200	300	-		
Short Circuit Current	Ishort	$V_{IN}=V_{EN2}=V_{OUT(T)}+1.0V, V_{OUT}=0V$	-	50	-	mA	①

Unless otherwise stated, $V_{EN2}=V_{IN}$ for the XC6412B series.

When the series are the XC6411P and XC6412C series, V_{IN} shown in the conditions represents V_{IN1} or V_{IN2} .

(*1) $V_{OUT(T)}$: Nominal output voltage

(*2) $V_{OUT(E)}$: Effective output voltage

(i.e. the output voltage when " $V_{OUT(T)} + 1.0V$ " is provided at the V_{IN} pin while maintaining a certain I_{OUT} value).

(*3) $V_{dif} = \{ V_{IN1} - V_{OUT1} \}$

V_{IN1} = The input voltage when V_{OUT1} appears as input voltage is gradually decreased.

V_{OUT1} = A voltage equal to 98% of the output voltage whenever an amply stabilized $I_{OUT} \{V_{OUT(T)} + 1.0V\}$ is input.

(*4) Refer to "VOLTAGE CHART".

XC6411P Series: Regulator 1, Regulator 2 (each channel)

Ta = 25°C

PARAMETER	SYMBOL	CONDITIONS	MIN.	TYP.	MAX.	UNITS	CIRCUIT
Supply Current ^(*5)	I _{DD}	$V_{OUT(T)} \leq 3.9V$	-	0.8	1.5	μA	②
		$V_{OUT(T)} \geq 4.0V$		1.0	1.8	μA	②

Unless otherwise stated, $V_{IN}=V_{OUT(T)}+1.0V$.

(*5) Supply current shows per channel.

XC6412B Series

Ta = 25°C

PARAMETER	SYMBOL	CONDITIONS	MIN.	TYP.	MAX.	UNITS	CIRCUIT
Supply Current 2 ^(*6)	I _{DD2}	$V_{EN2}=V_{IN}$ $V_{OUT(T)} \leq 3.9V$	-	1.6	3.0	μA	②
		$V_{EN2}=V_{IN}$ $V_{OUT(T)} \geq 4.0V$	-	2.0	3.6	μA	②
Supply Current 3 ^(*7)	I _{DD3}	$V_{EN2}=V_{SS}$ $V_{OUT(T)} \leq 3.9V$	-	0.8	1.6	μA	②
		$V_{EN2}=V_{SS}$ $V_{OUT(T)} \geq 4.0V$	-	1.0	1.9	μA	②
EN2 'H' Level Voltage	V _{ENH}		1.0	-	6.0	V	①
EN2 'L' Level Voltage	V _{ENL}		-	-	0.3	V	①
EN2 'H' Level Current	I _{ENH}	$V_{EN2}=V_{IN}$	-0.1	-	0.1	μA	②
EN2 'L' Level Current	I _{ENL}	$V_{EN2}=V_{SS}$	-0.1	-	0.1	μA	②

Unless otherwise stated, $V_{IN}=V_{OUT(T)}+1.0V$.

(*6) Supply current of the IC: (VR1 supply current + VR2 supply current)

(*7) Supply current of the IC when VR2 is in stand-by mode: (VR1 supply current + VR2 stand-by current)

■ ELECTRICAL CHARACTERISTICS (Continued)

● Voltage Chart

Ta = 25°C

PARAMETER	E-0		E-1	
	OUTPUT VOLTAGE (V)		DROPOUT VOLTAGE 1 (mV)	
NOMINAL OUTPUT VOLTAGE	V _{OUT}		V _{dif}	
V _{OUT(T)}	MIN.	MAX.	TYP.	MAX.
0.9	0.870	0.930	870	1000
1.0	0.970	1.030	860	1000
1.1	1.070	1.130	780	950
1.2	1.170	1.230	800	1000
1.3	1.270	1.330	720	900
1.4	1.370	1.430	750	960
1.5	1.470	1.530	700	890
1.6	1.568	1.632	680	860
1.7	1.666	1.734	650	830
1.8	1.764	1.836	630	800
1.9	1.862	1.938	610	780
2.0	1.960	2.040	580	740
2.1	2.058	2.142	580	740
2.2	2.156	2.244	580	740
2.3	2.254	2.346	510	650
2.4	2.352	2.448	510	650
2.5	2.450	2.550	450	580
2.6	2.548	2.652	450	580
2.7	2.646	2.754	450	580
2.8	2.744	2.856	450	580
2.9	2.842	2.958	450	580
3.0	2.940	3.060	320	420
3.1	3.038	3.162	320	420
3.2	3.136	3.264	320	420
3.3	3.234	3.366	320	420
3.4	3.332	3.468	320	420
3.5	3.430	3.570	320	420
3.6	3.528	3.672	320	420
3.7	3.626	3.774	320	420
3.8	3.724	3.876	320	420
3.9	3.822	3.978	320	420
4.0	3.920	4.080	290	380
4.1	4.018	4.182	290	380
4.2	4.116	4.284	290	380
4.3	4.214	4.386	290	380
4.4	4.312	4.488	290	380
4.5	4.410	4.590	290	380
4.6	4.508	4.692	290	380
4.7	4.606	4.794	290	380
4.8	4.704	4.896	290	380
4.9	4.802	4.998	290	380
5.0	4.900	5.100	230	310

TEST CIRCUITS

●XC6411P Series

Circuit ①

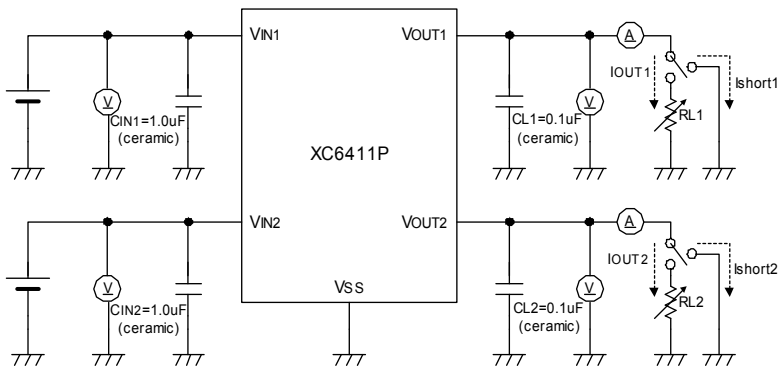

Circuit ②

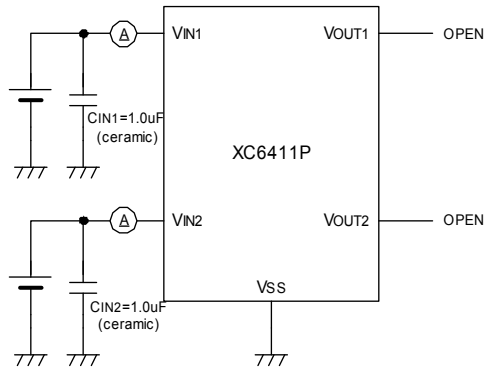

●XC6412B Series

Circuit ①

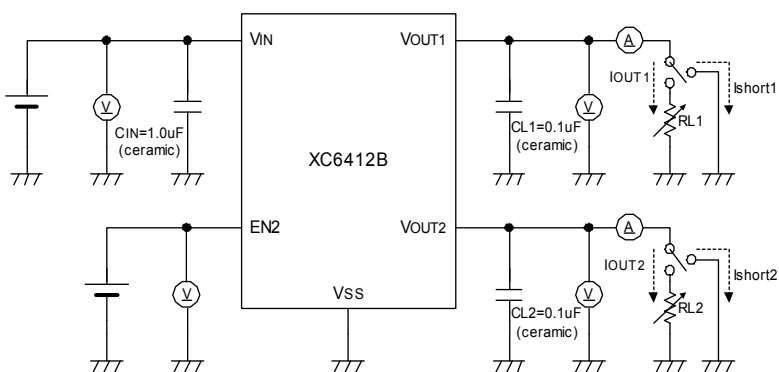

Circuit ②

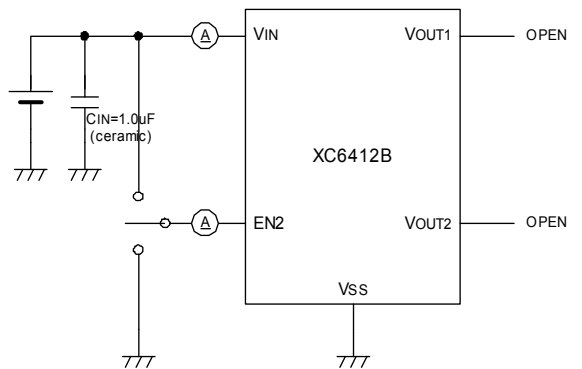

OPERATIONAL EXPLANATION

<Output Voltage Control>

The voltage, divided by resistors R11 & R12 for a regulator 1 and R21 & R22 for a regulator 2 is compared with the internal reference voltage by the error amplifier. These resistors are connected to the VOUT pin. The P-channel MOSFET connected to the VOUT pin is then driven by the subsequent output signal. The output voltage at the VOUT pin is controlled and stabilized by a system of negative feedback. The current limit circuit operates when the load current reaches the current limit level.

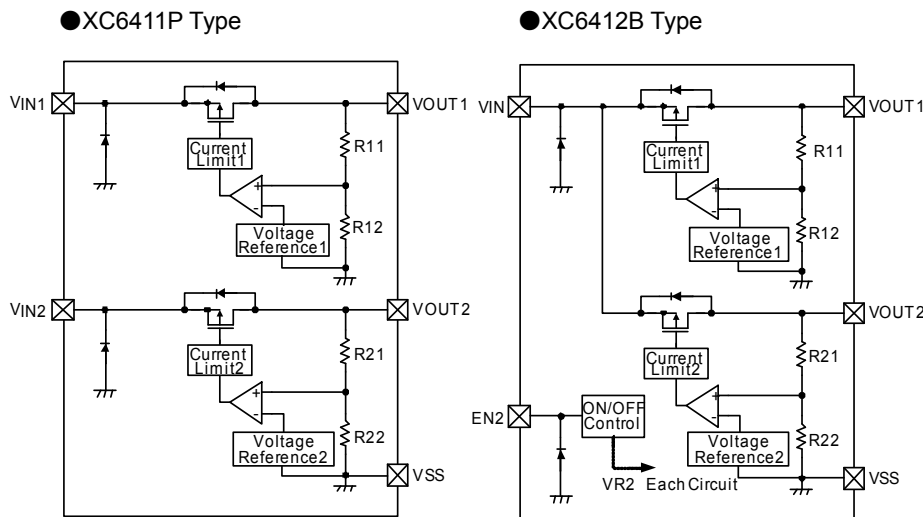

* Diodes shown in the above circuit are ESD protection diodes and parasitic diodes.

<Dual Inputs>

In the XC6411P series, the two input voltage pins are separated. The two regulators 1 and 2 can operate independently so that it offers design flexibility.

<Short Protection Circuit>

The XC6411P/XC6412B series' regulator offers short-circuit protection by means of a built-in foldback circuit. When the load current reaches the current limit level, the fixed current limiter circuit operates and output voltage drops. As a result of this drop in output voltage, the foldback circuit operates, the output voltage drops further and output current decreases. When the output voltage pin is shorted, a current of about 50mA flows.

<EN2 Pin>

The regulator 2's internal circuitry can be operated or shutdown via the signal from the EN2 pin with the XC6412 series. In so doing the regulator 1 maintains an operational state constantly. In shutdown mode, output at the VOUT2 pin will be pulled down to the VSS level via R21 & R22. Note that the XC6412 series' regulator is "High Active/No Pull-Down", operations will become unstable with the EN2 pin open. We suggest that you use this IC with either a VIN voltage or a VSS voltage input at the EN2 pin. If this IC is used with the correct specifications for the EN pin, the operational logic is fixed and the IC will operate normally. However, supply current may increase as a result of through current in the IC's internal circuitry.

NOTES ON USE

- For temporary, transitional voltage drop or voltage rising phenomenon, the IC is liable to malfunction should the ratings be exceeded.
- Where wiring impedance is high, operations may become unstable due to noise and/or phase lag depending on output current.
- As for the XC6412 series, internally achieved phase compensation makes a stable operation of the IC possible even when there is no output capacitor (C_L). In order to stabilize the V_{IN} 's voltage level, we recommend that an input capacitor (C_{IN}) of about 0.1 to 1.0 μF be connected between each V_{IN} pin and the V_{SS} pin. Moreover, during transient response, so as to prevent an undershoot or overshoot, we recommend that the output capacitor (C_L) of about 0.1 to 1.0 μF be connected between each V_{OUT} pin and the V_{SS} pin. However, please wire the input capacitor (C_{IN}) and the output capacitor (C_L) as close to the IC as possible.
- Torex places an importance on improving our products and their reliability. We request that users incorporate fail-safe designs and post-aging protection treatment when using Torex products in their systems.

TYPICAL PERFORMANCE CHARACTERISTICS

●XC6411P/6412B Series

(1) Output Voltage vs. Output Current

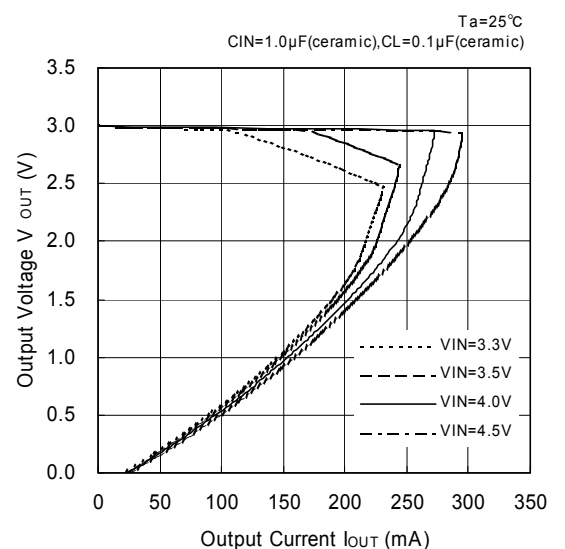
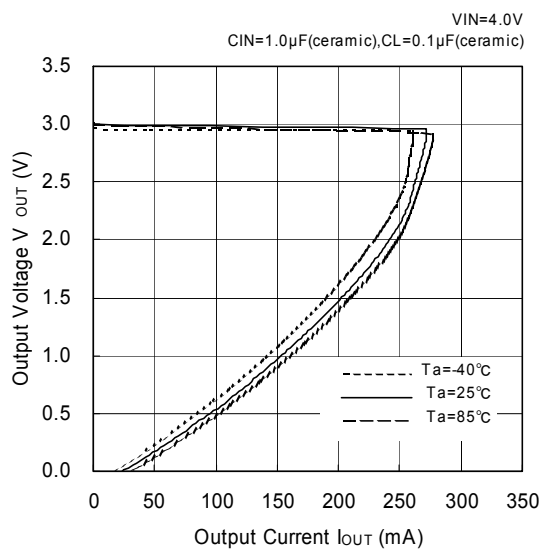
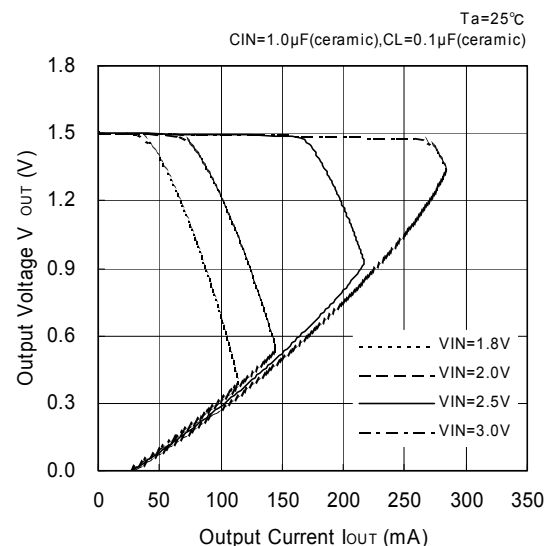
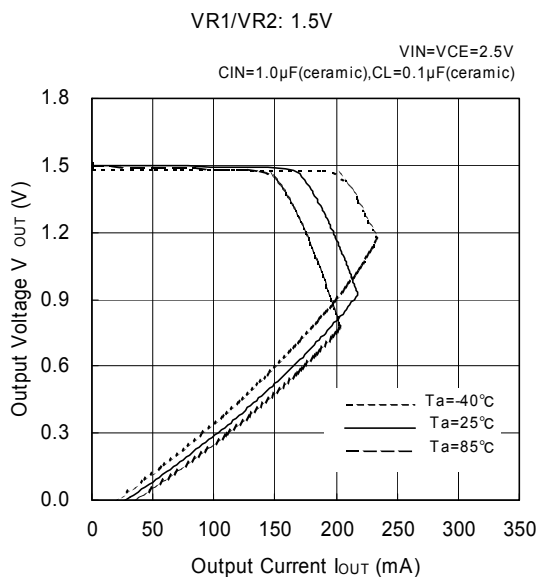
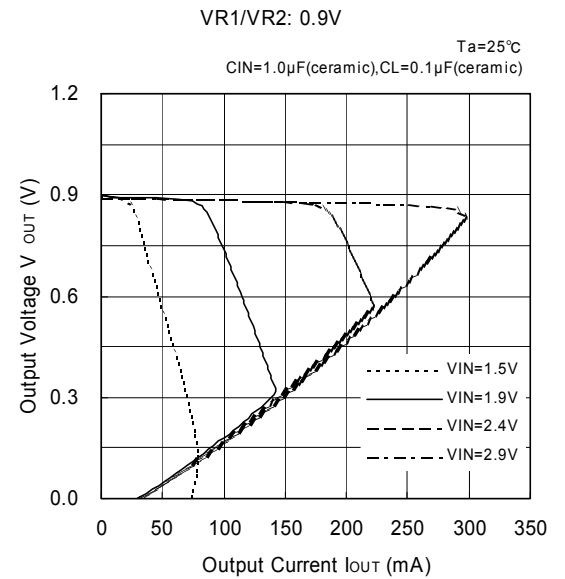
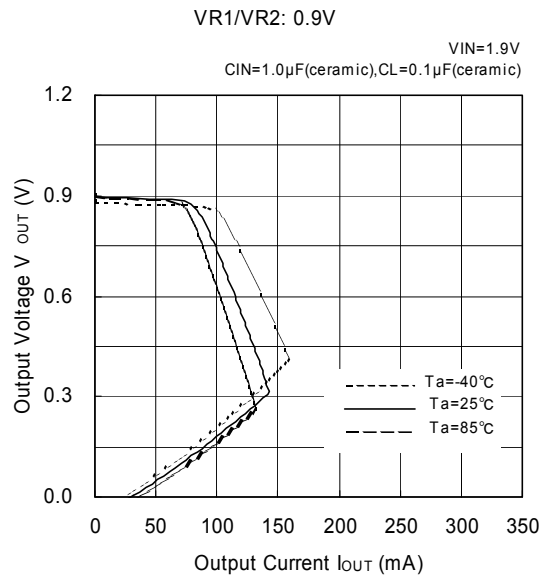

TYPICAL PERFORMANCE CHARACTERISTICS (Continued)

(1) Output Voltage vs. Output Current (Continued)

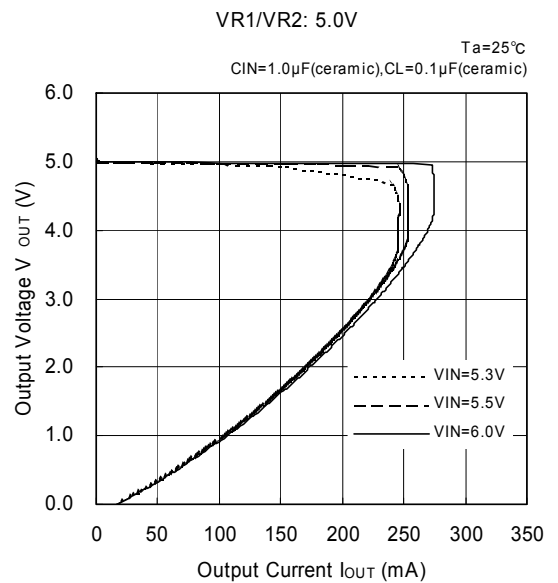
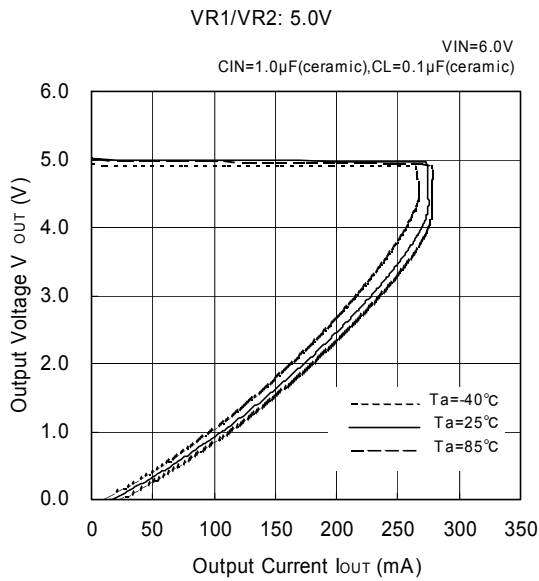

(2) Output Voltage vs. Input Voltage

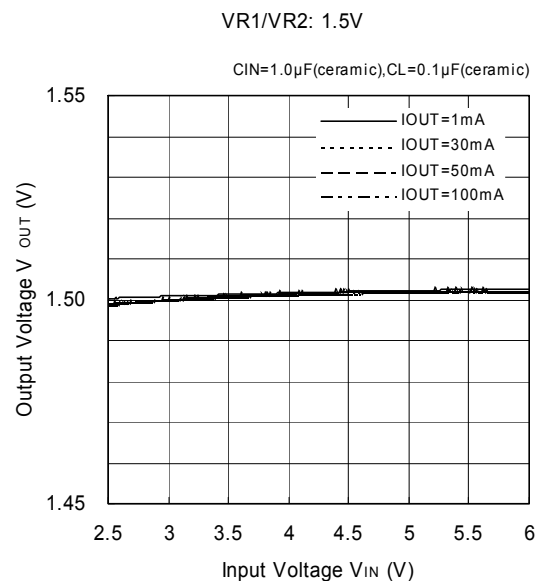
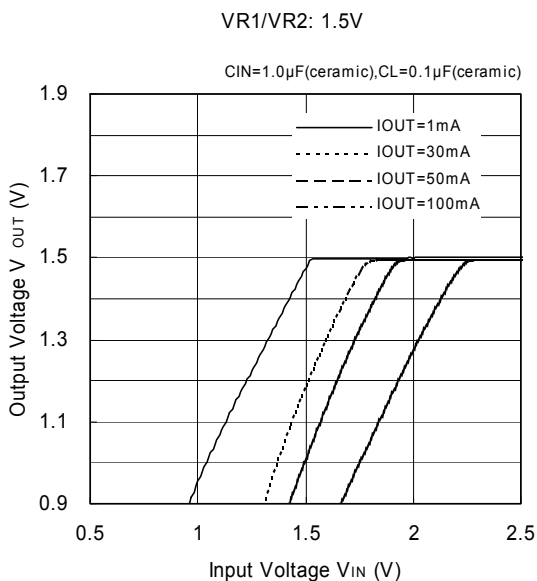
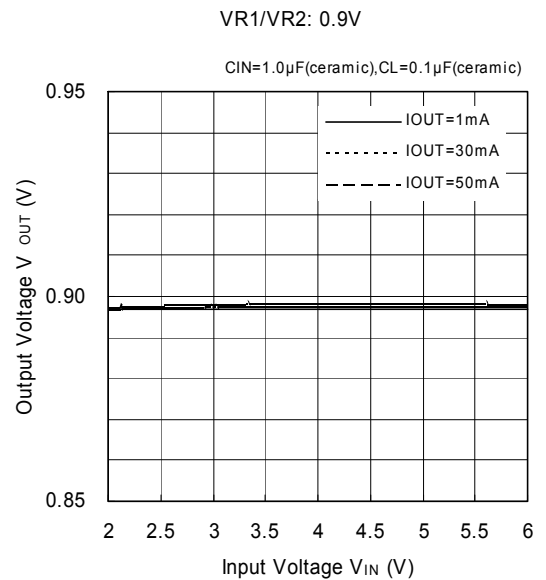
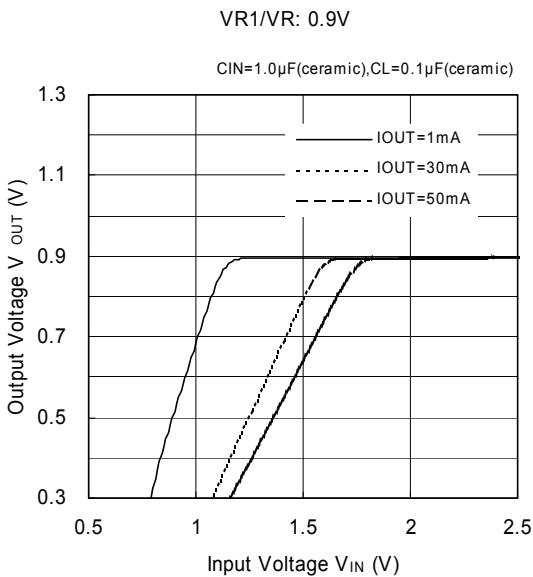

■ TYPICAL PERFORMANCE CHARACTERISTICS (Continued)

(2) Output Voltage vs. Input Voltage (Continued)

VR1/VR2: 3.0V

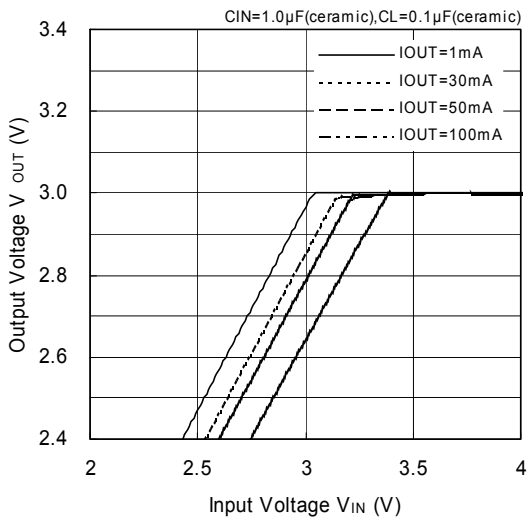

VR1/VR2: 3.0V

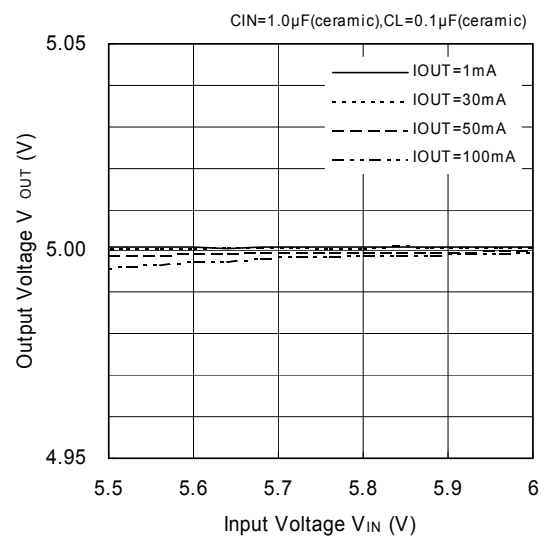
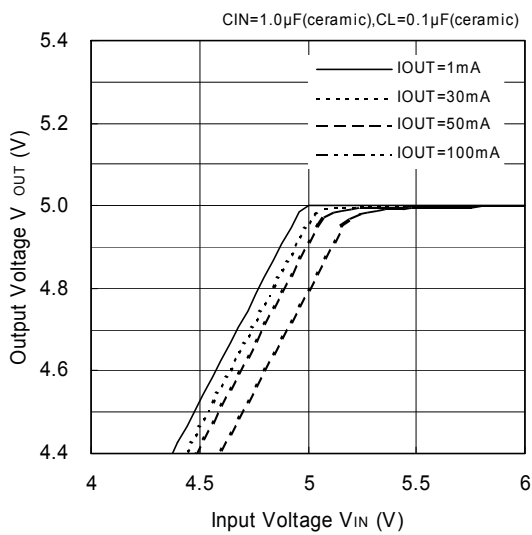
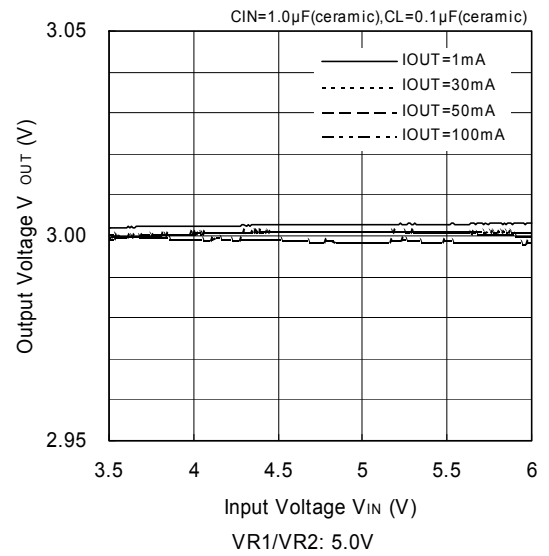

(3) Dropout Voltage vs. Output Current

VR1/VR2: 0.9V

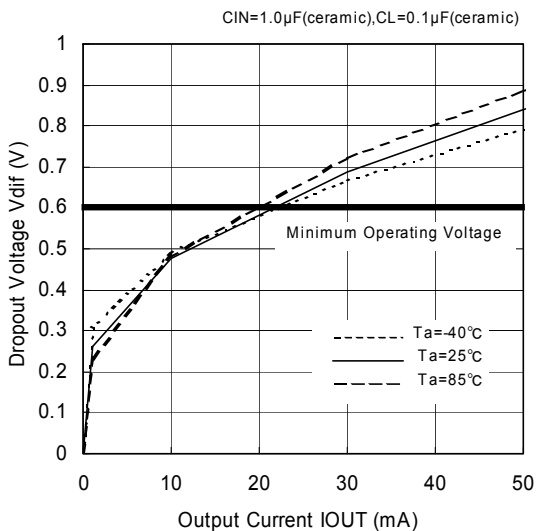

VR1/VR2: 1.5V

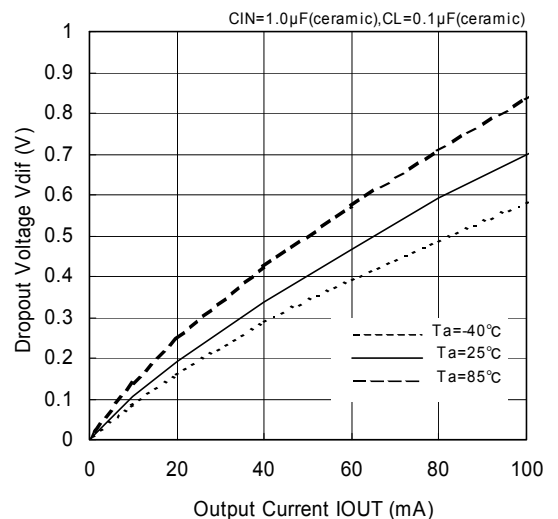

TYPICAL PERFORMANCE CHARACTERISTICS (Continued)

(3) Dropout Voltage vs. Output Current (Continued)

VR1/VR2: 3.0V

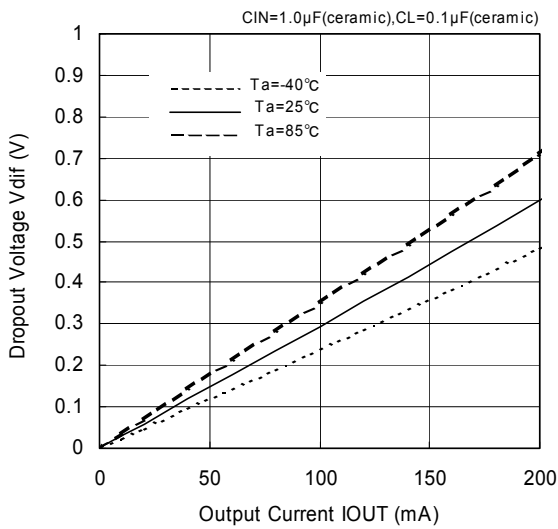

VR1/VR2: 5.0V

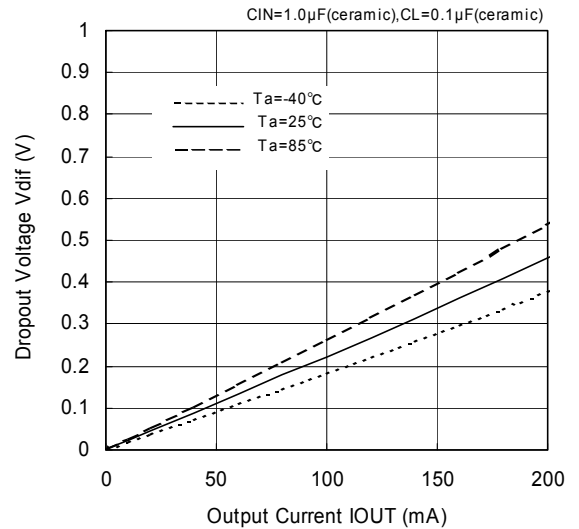

(4) Supply Current vs. Input Voltage

VR1/VR2: 0.9V

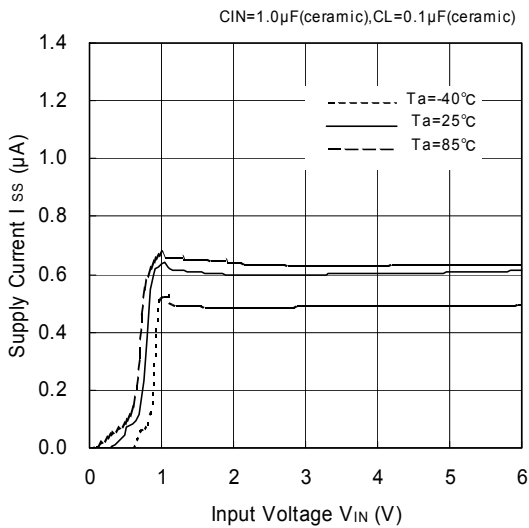

VR1/VR2: 3.0V

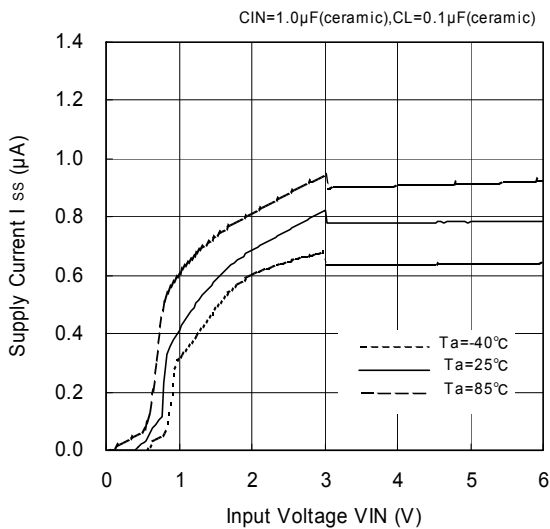

VR1/VR2: 1.5V

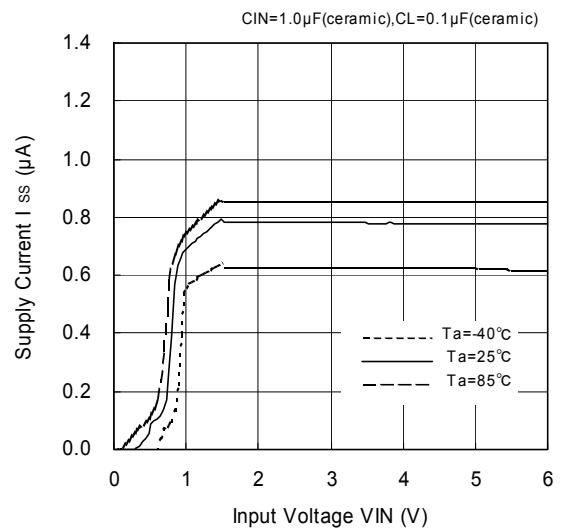

VR1/VR2: 5.0V

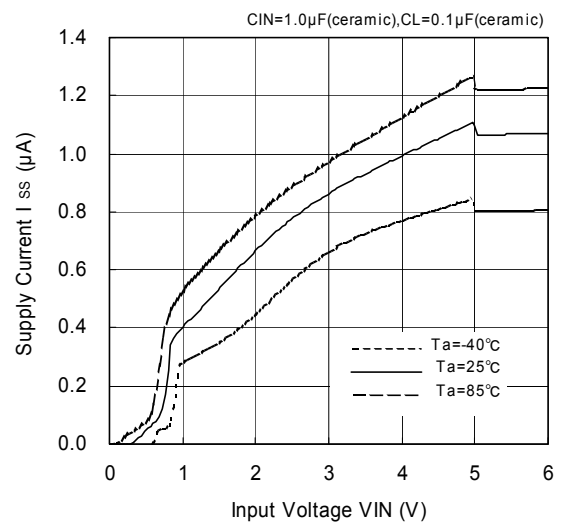

TYPICAL PERFORMANCE CHARACTERISTICS (Continued)

(5) Output Voltage vs. Ambient Temperature
VR1/VR2: 0.9V

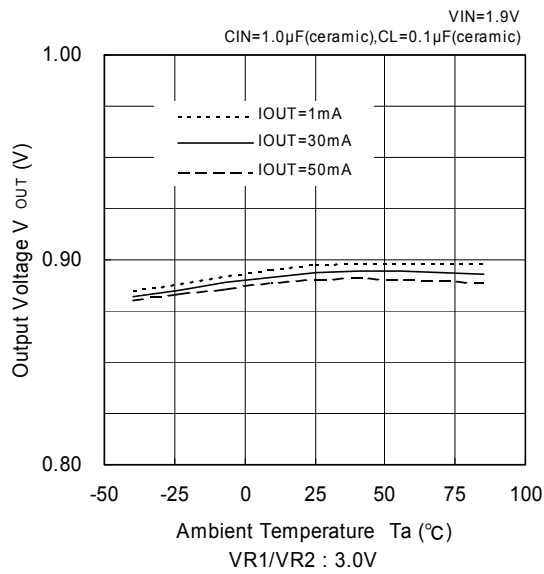

VR1/VR2: 1.5V

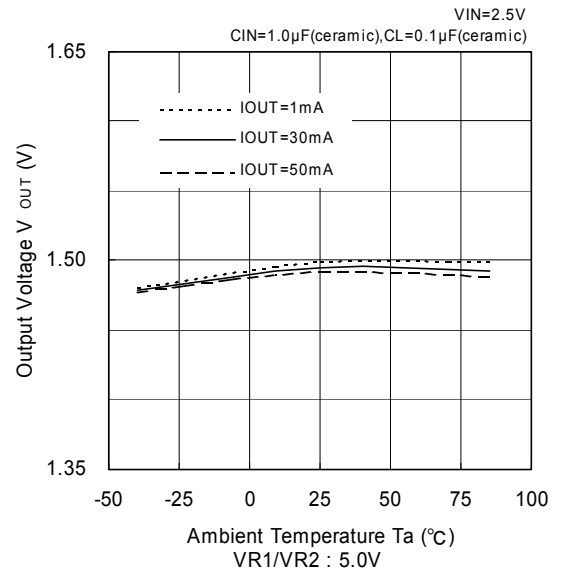

VR1/VR2: 3.0V

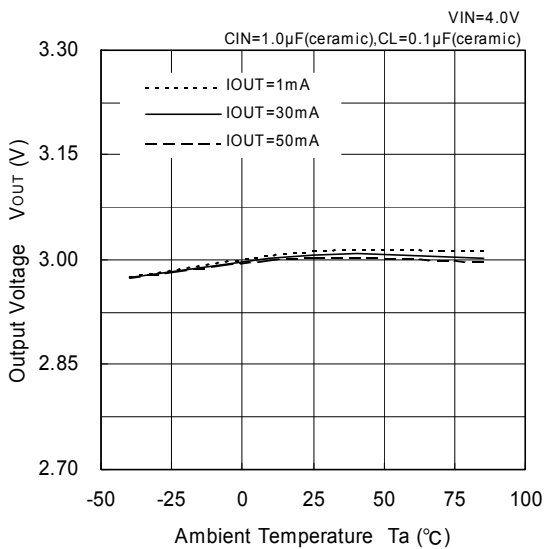

VR1/VR2: 5.0V

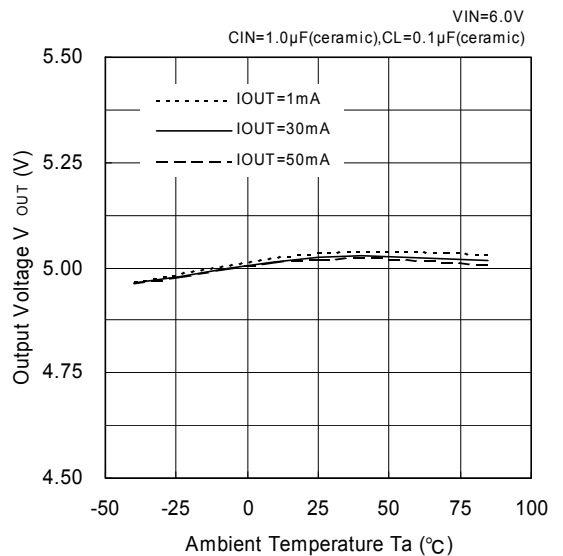

(6) Supply Current vs. Ambient Temperature
VR1/VR2: 0.9V

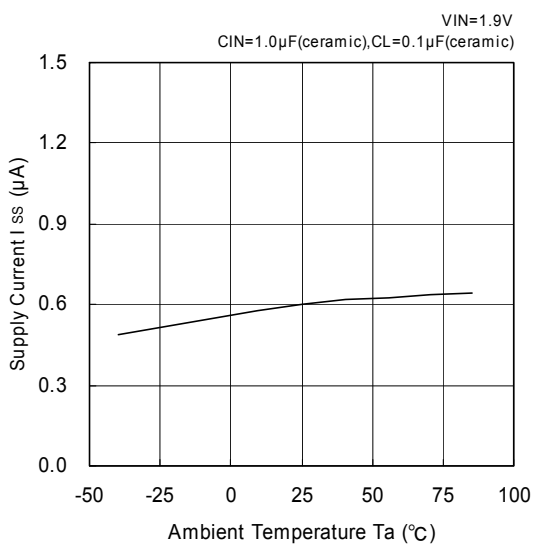

VR1/VR2: 1.5V

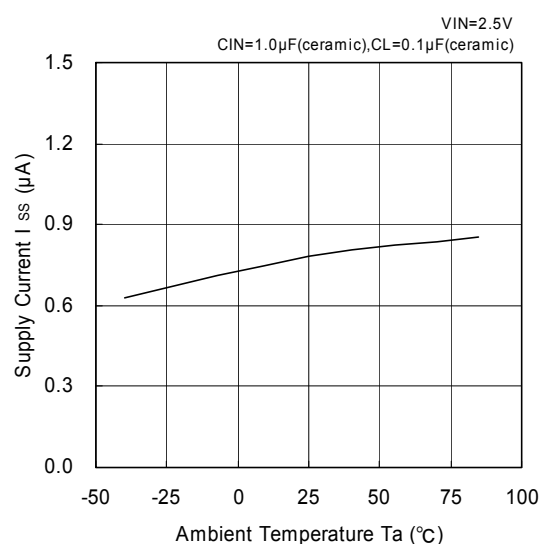

TYPICAL PERFORMANCE CHARACTERISTICS (Continued)

(6) Supply Current vs. Ambient Temperature (Continued)

VR1/VR2: 3.0V

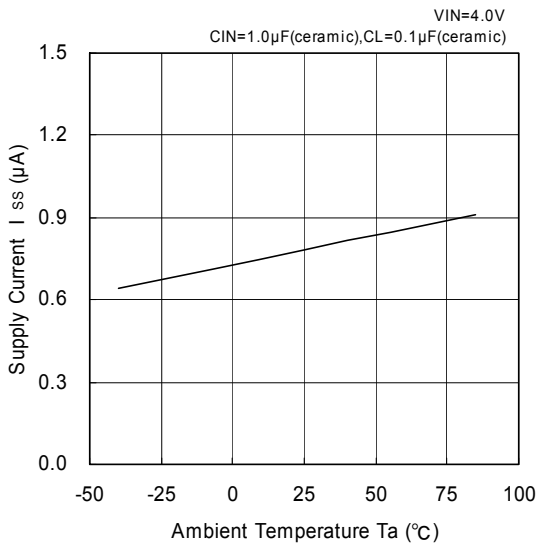

VR1/VR2: 5.0V

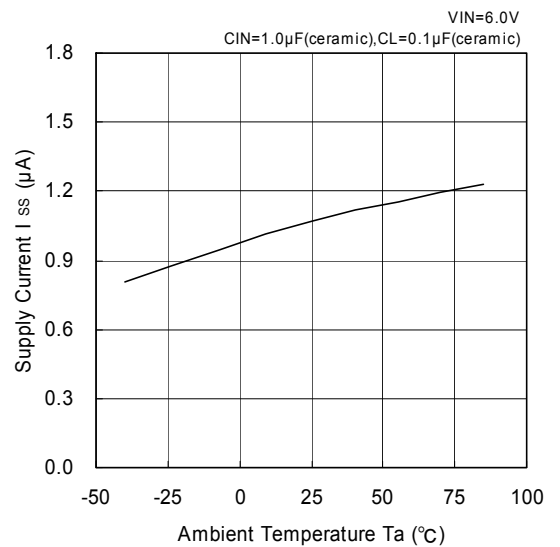

(7) EN2 Threshold Voltage vs. Ambient Temperature (XC6412B series)

XC6412B (VR2: 0.9V)

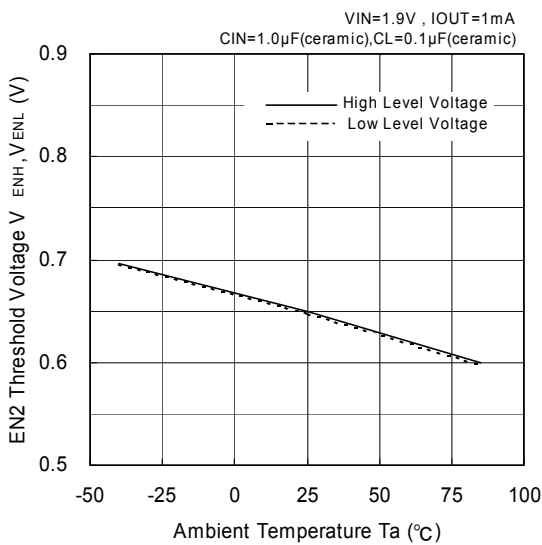

XC6412B (VR2: 1.5V)

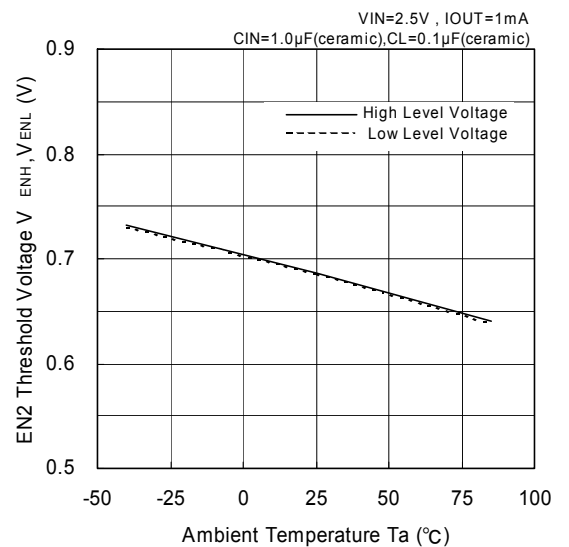

XC6412B (VR2: 3.0V)

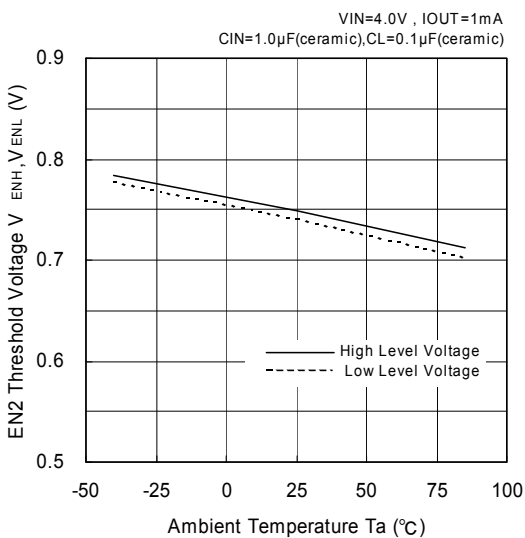

XC6412B (VR2: 5.0V)

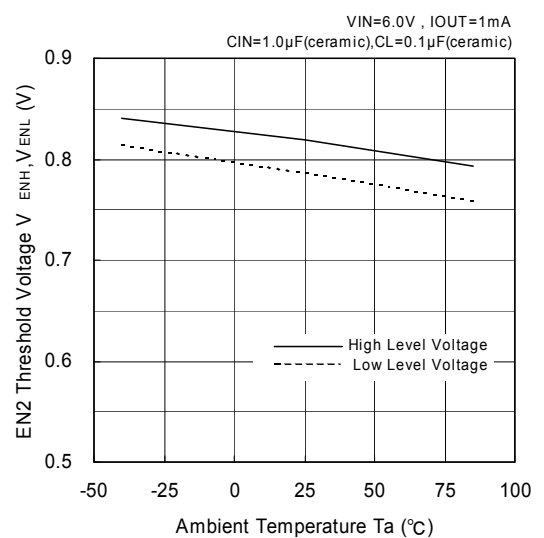

TYPICAL PERFORMANCE CHARACTERISTICS (Continued)

(8) Input Transient Response

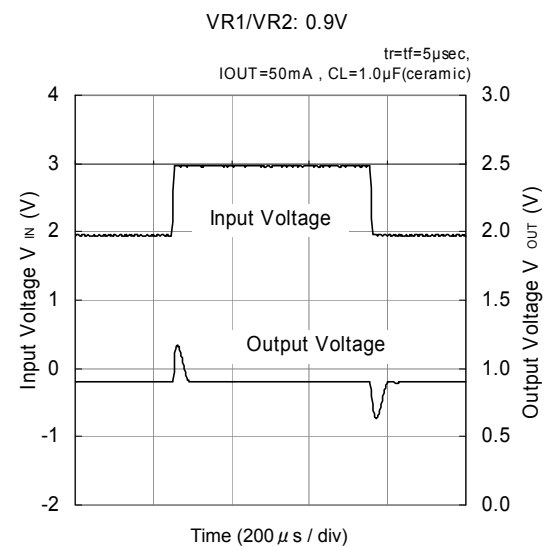
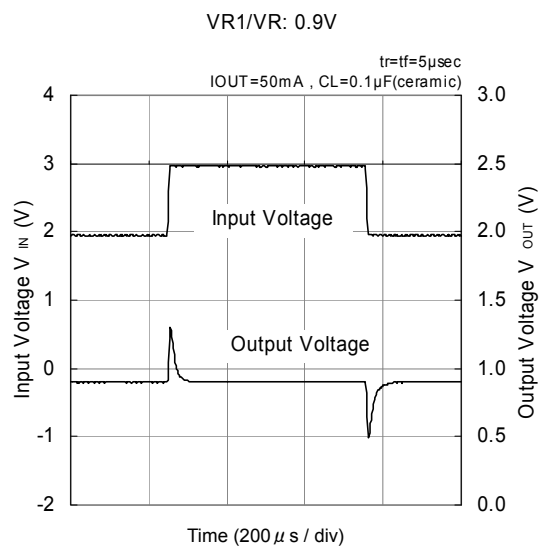
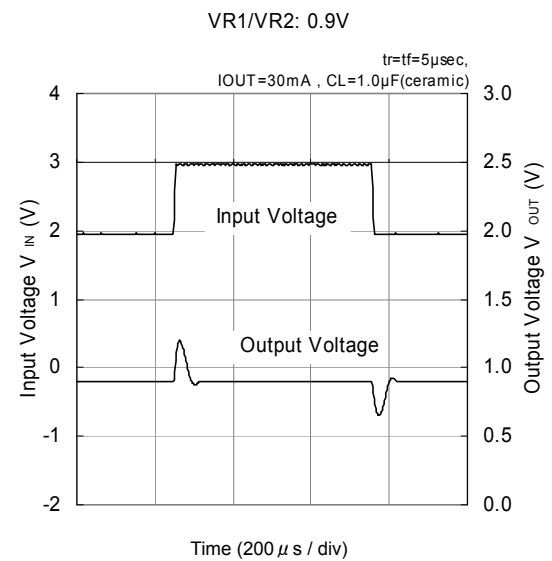
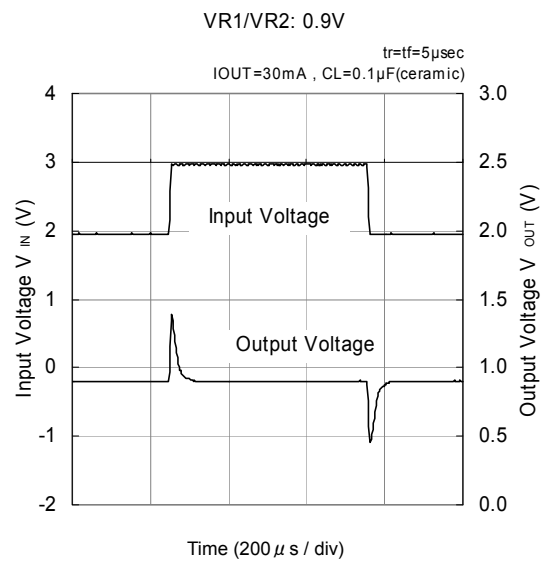
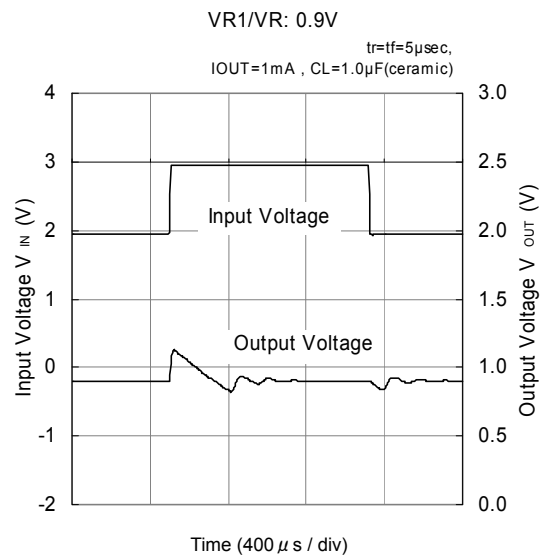
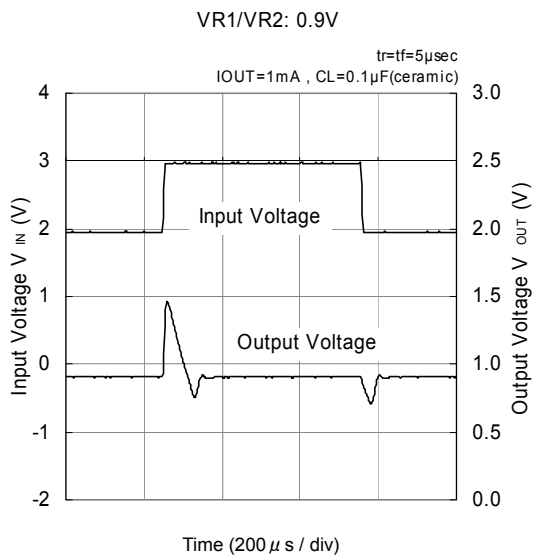

TYPICAL PERFORMANCE CHARACTERISTICS (Continued)

(8) Input Transient Response (Continued)

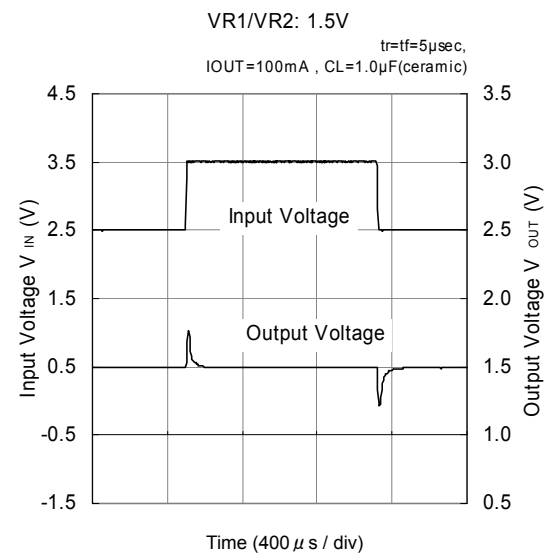
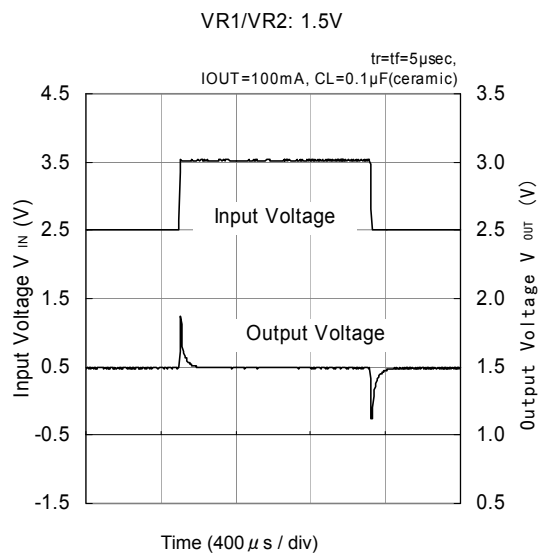
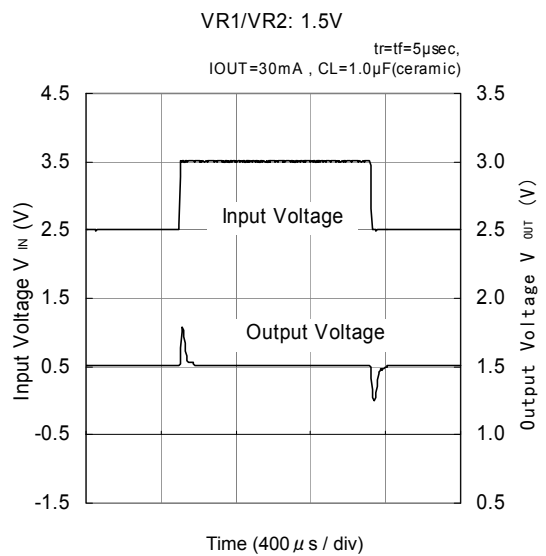
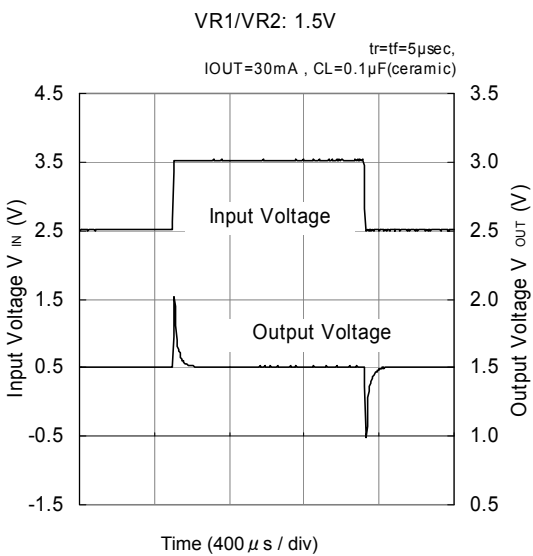
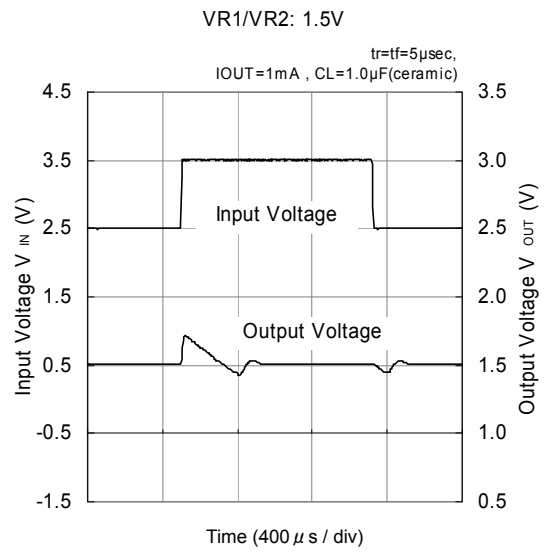
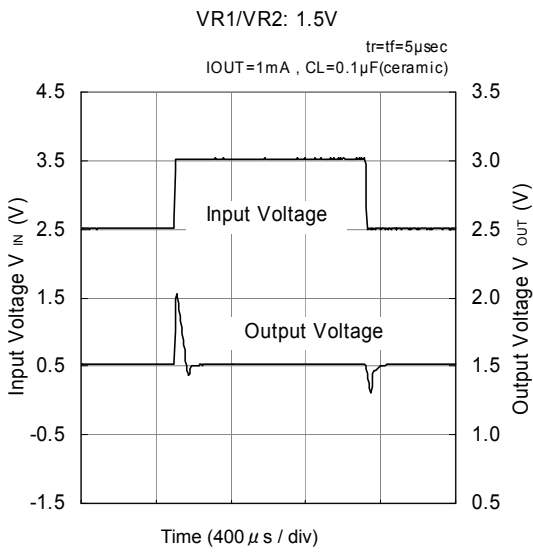

■ TYPICAL PERFORMANCE CHARACTERISTICS (Continued)

(8) Input Transient Response (Continued)

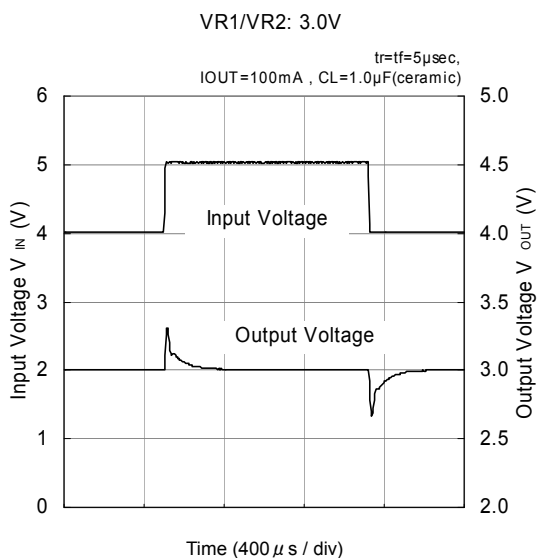
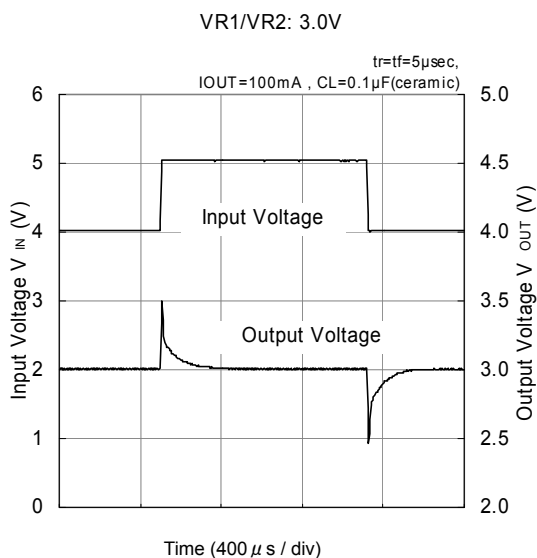
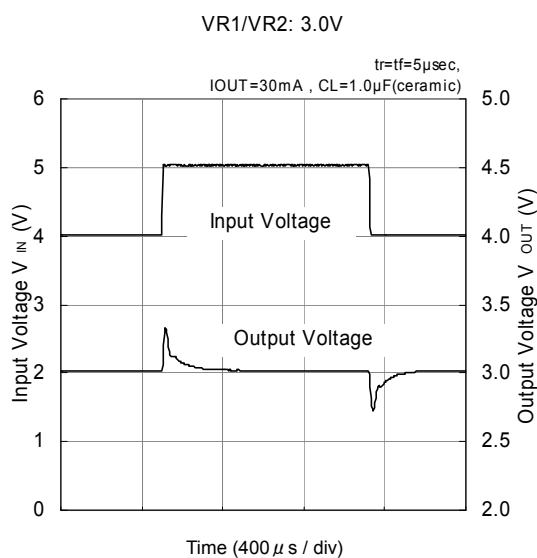
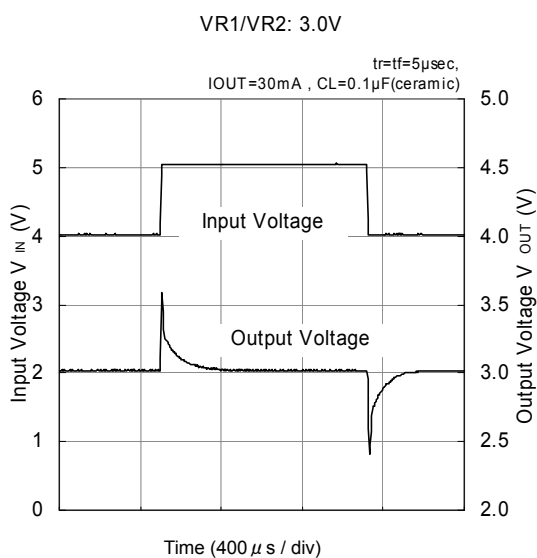
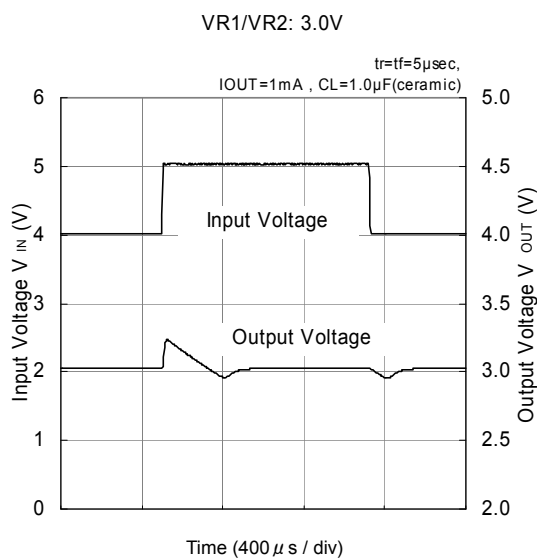
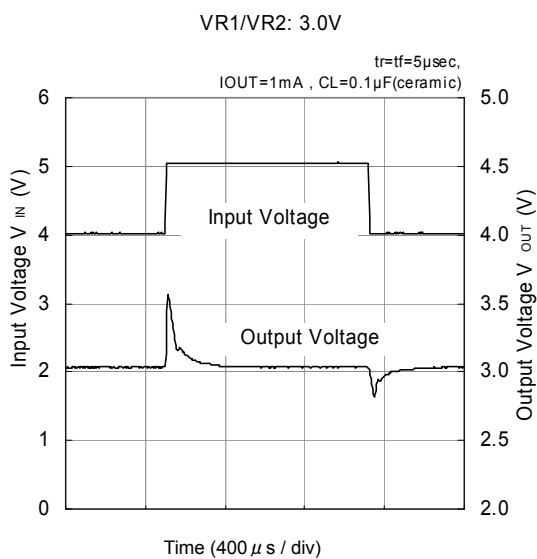

TYPICAL PERFORMANCE CHARACTERISTICS (Continued)

(8) Input Transient Response (Continued)

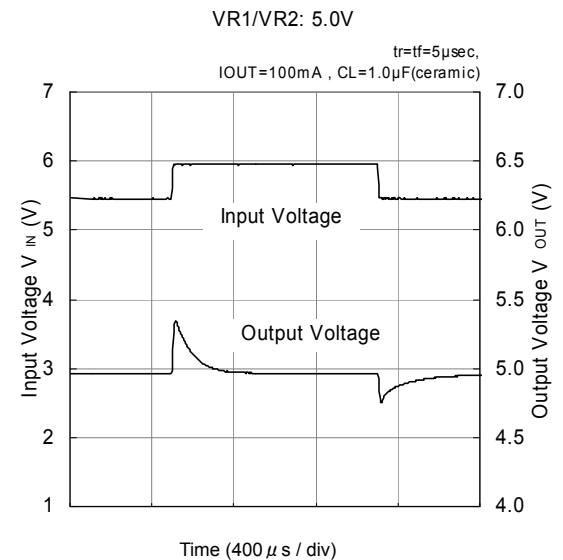
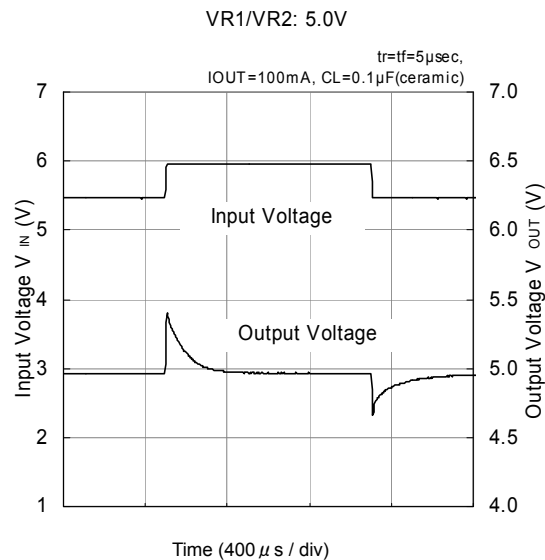
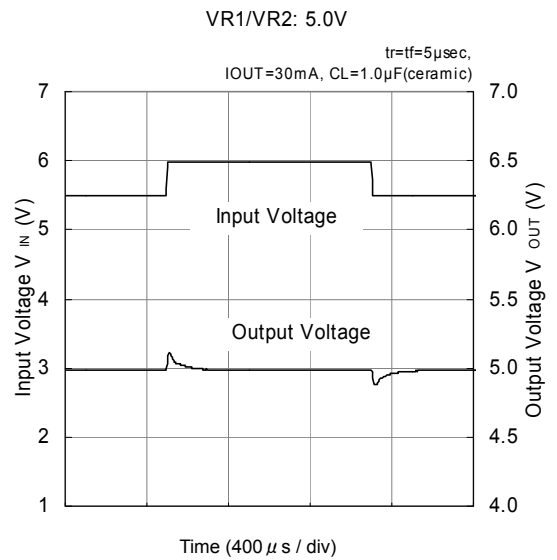
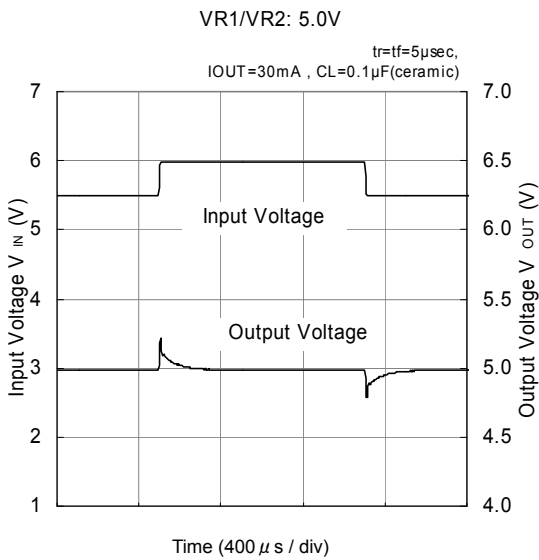
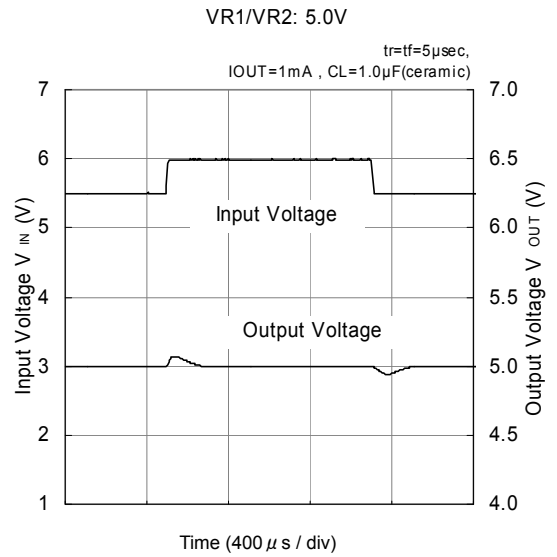
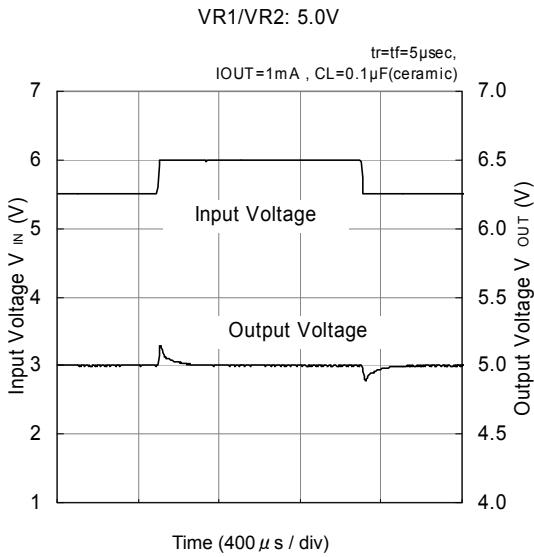

TYPICAL PERFORMANCE CHARACTERISTICS (Continued)

(9) Load Transient Response

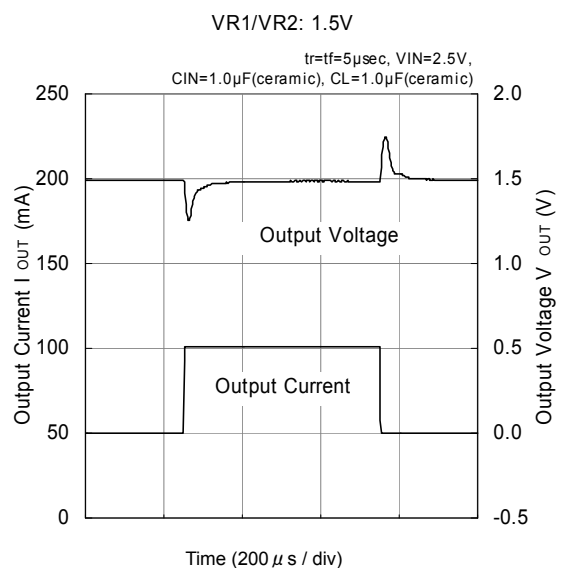
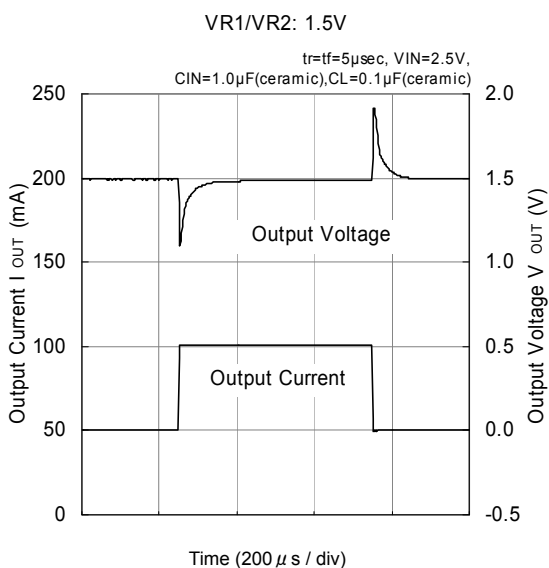
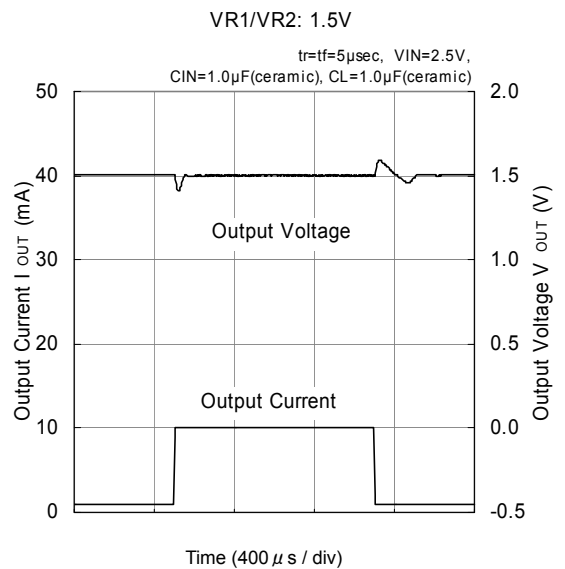
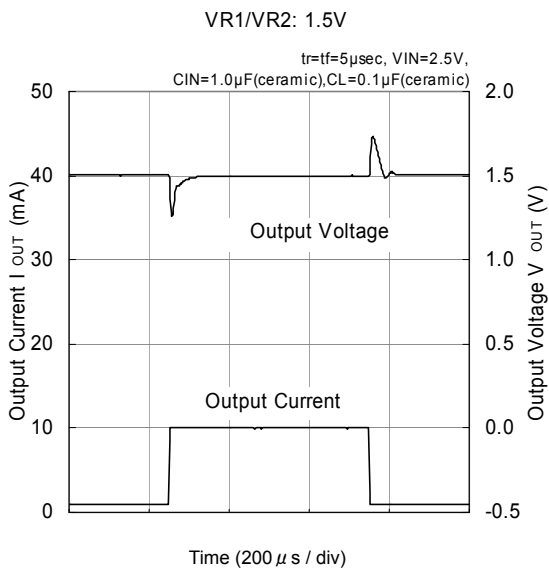
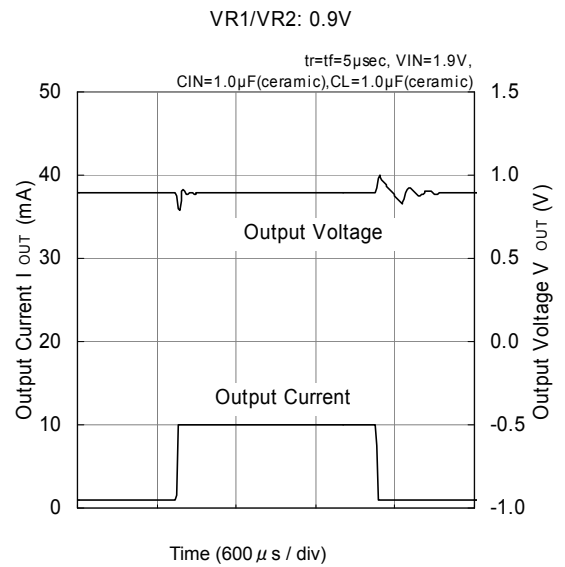
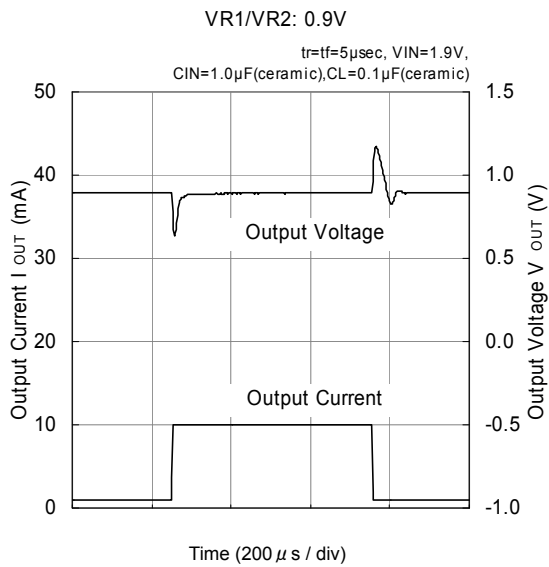

TYPICAL PERFORMANCE CHARACTERISTICS (Continued)

(9) Load Transient Response (Continued)

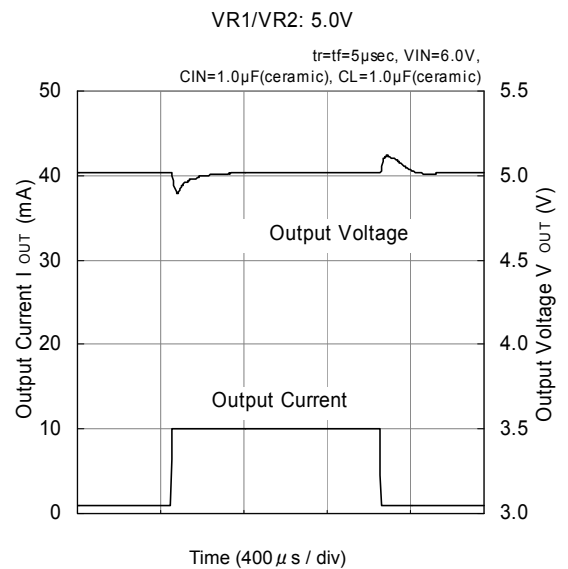
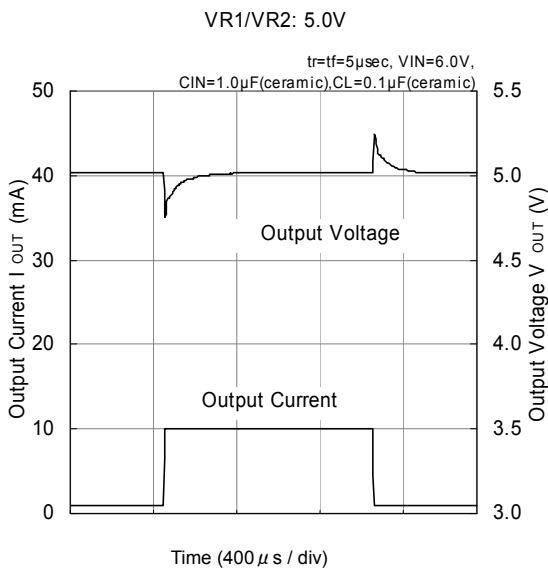
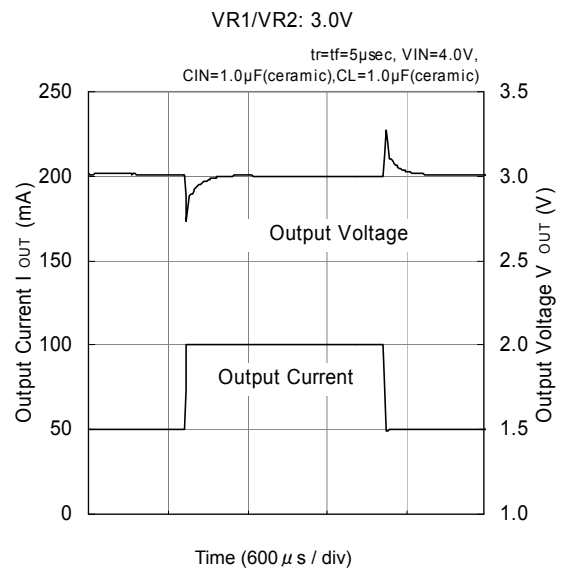
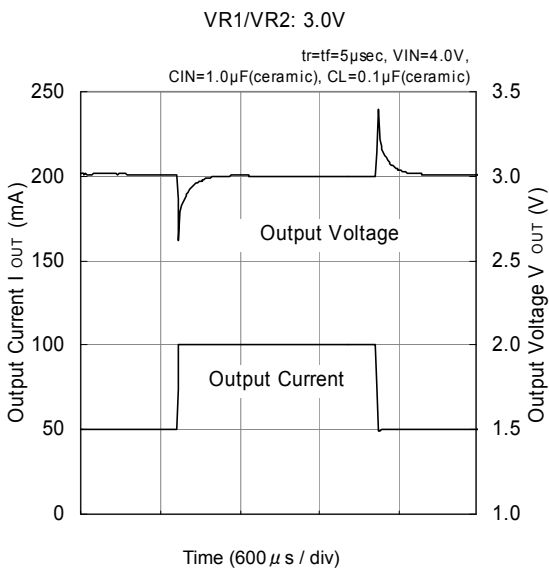
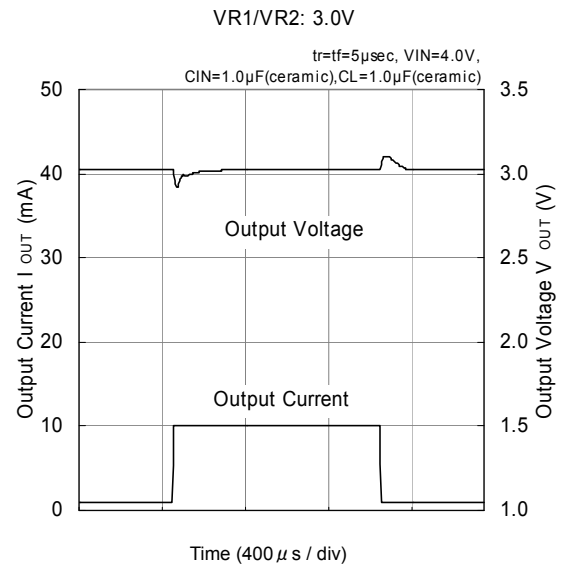
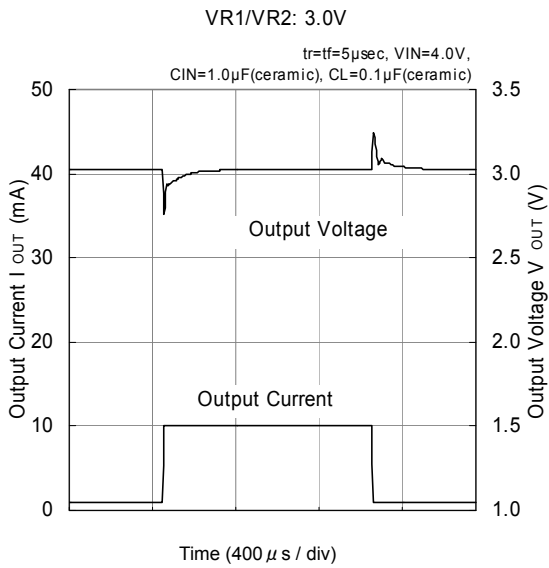

TYPICAL PERFORMANCE CHARACTERISTICS (Continued)

(9) Load Transient Response (Continued)

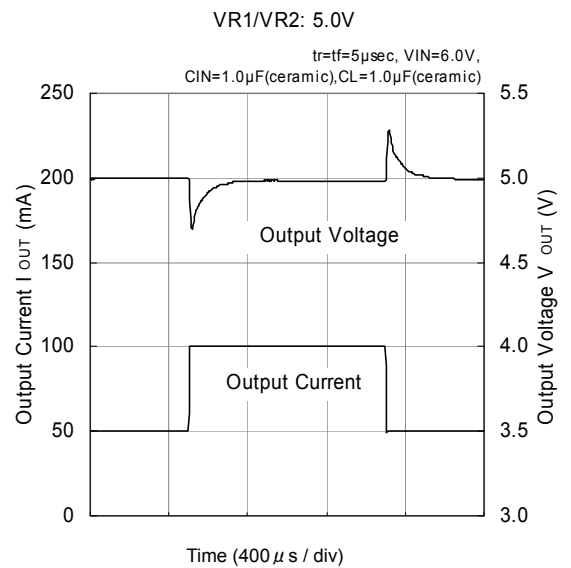
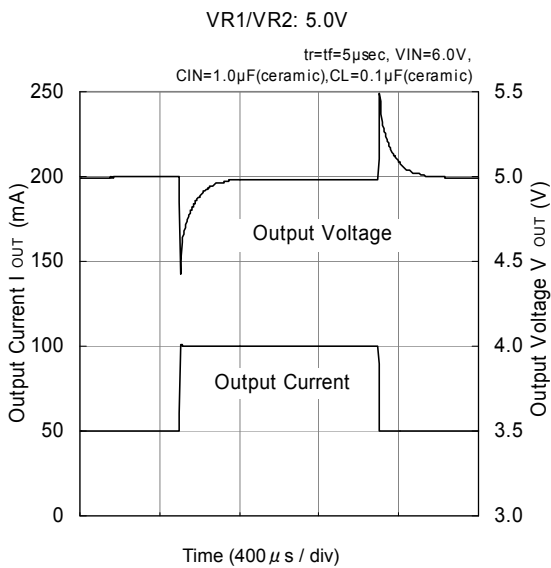

(10) Rising Response Time

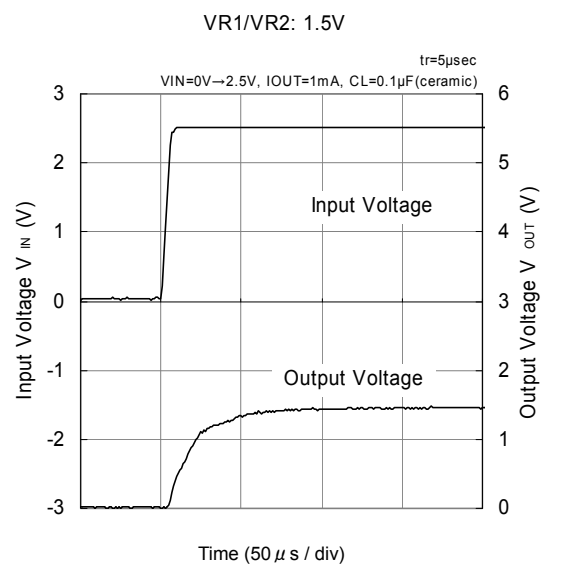
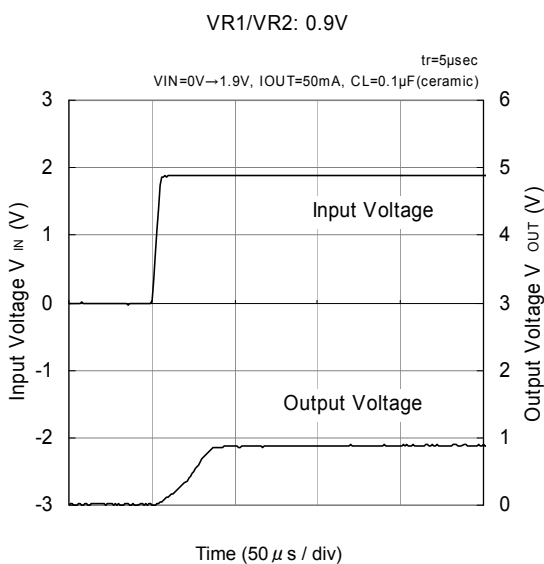
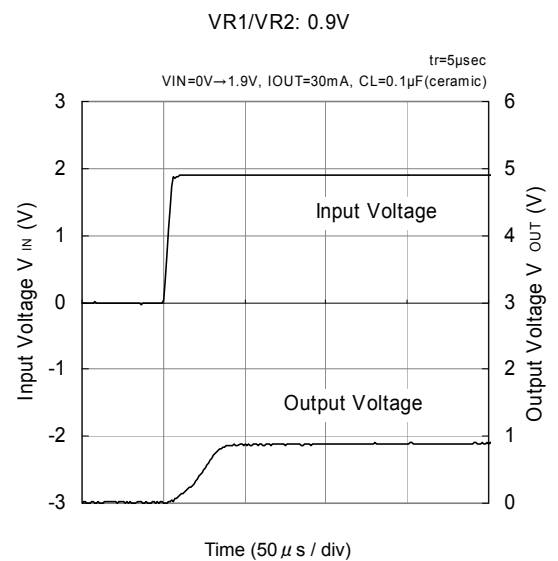
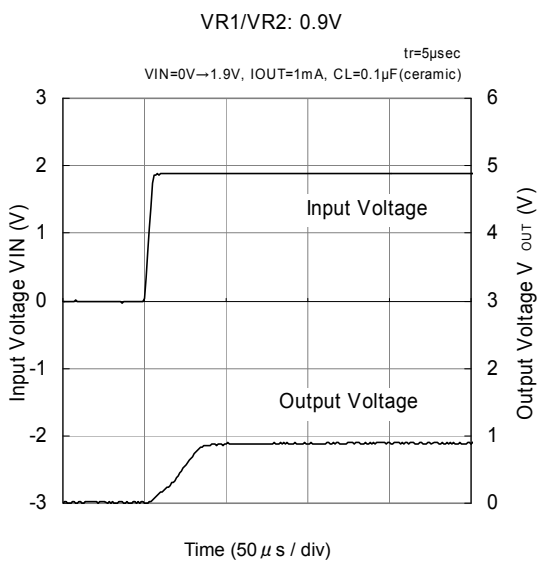

TYPICAL PERFORMANCE CHARACTERISTICS (Continued)

(10) Rising Response Time (Continued)

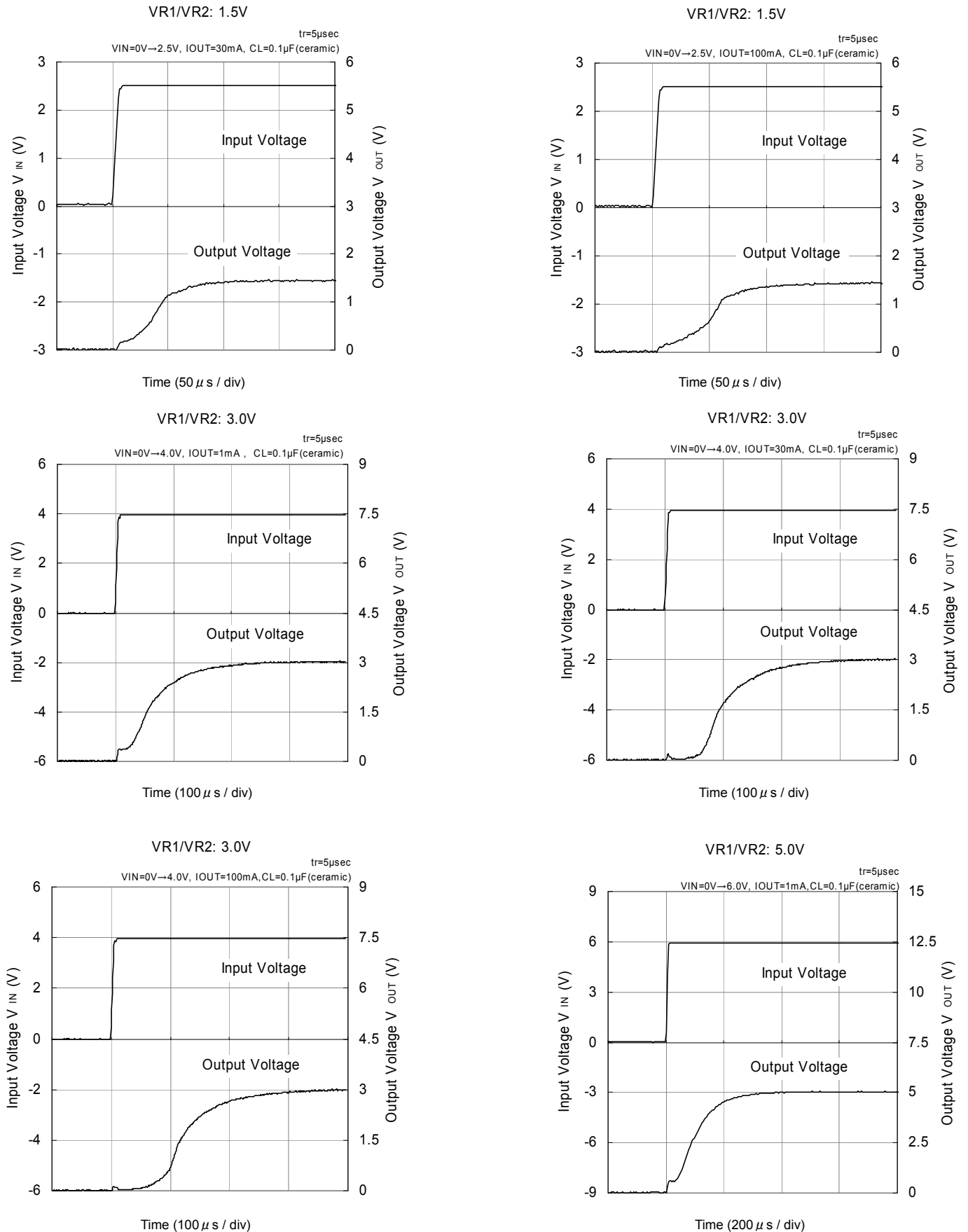

TYPICAL PERFORMANCE CHARACTERISTICS (Continued)

(10) Rising Response Time (Continued)

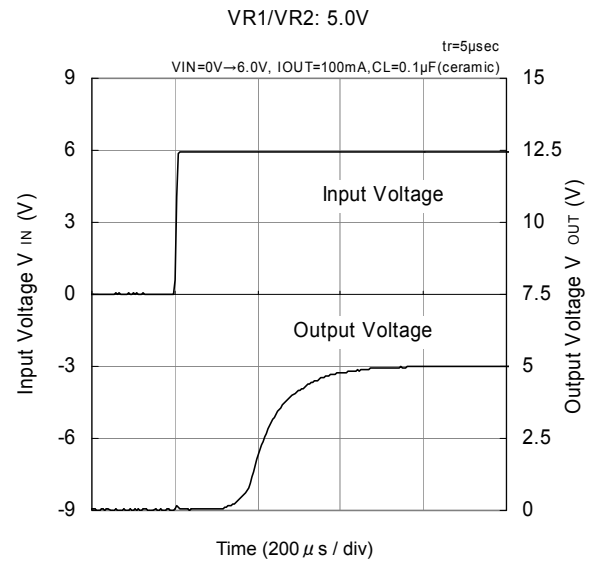
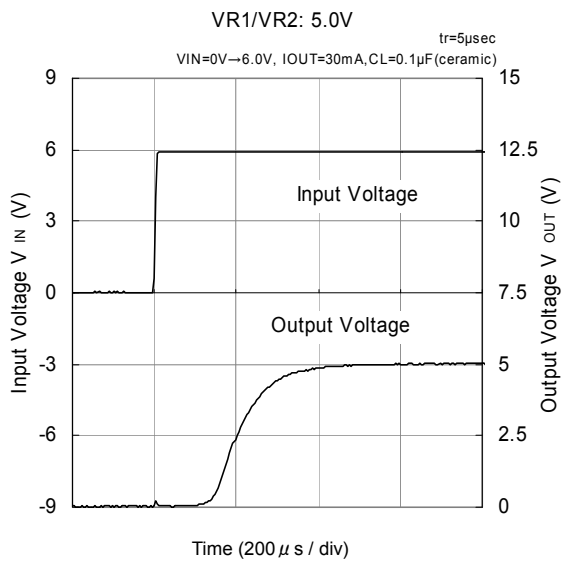

(11) EN2 Rising Response Time (For XC6412B series)

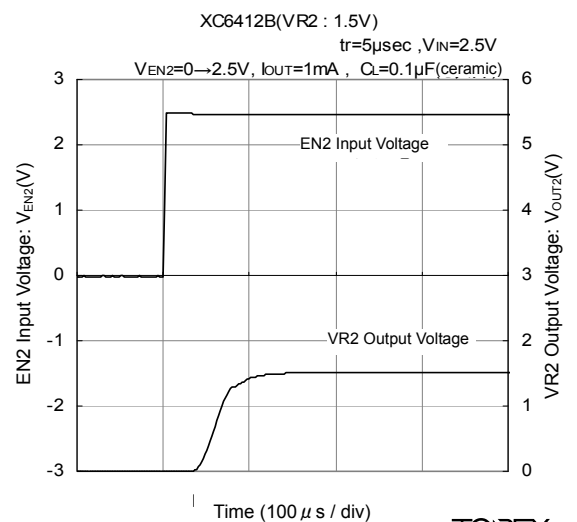
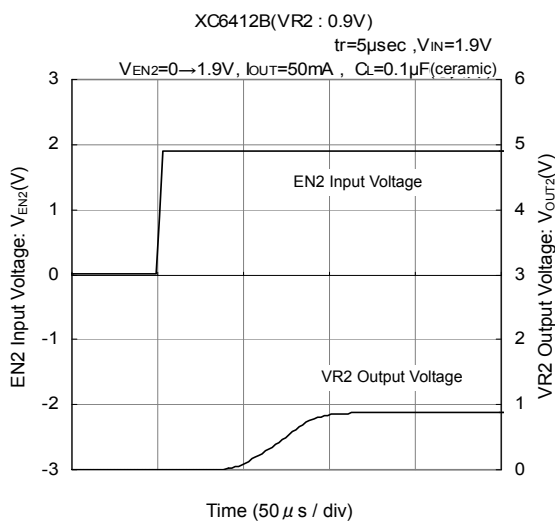
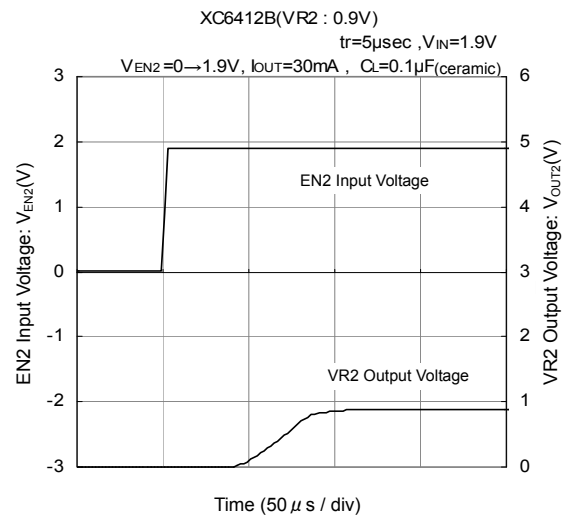
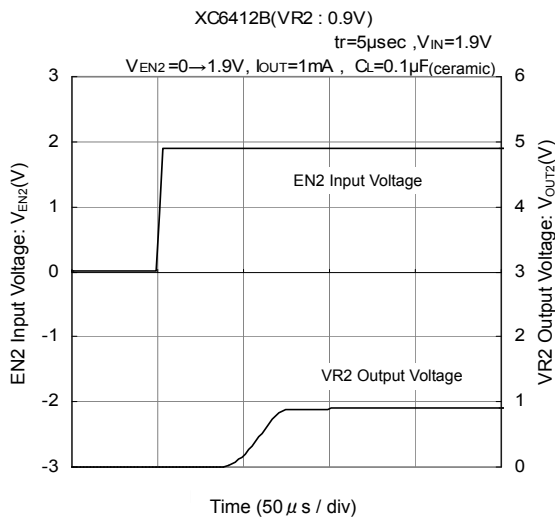

TYPICAL PERFORMANCE CHARACTERISTICS (Continued)

(11) EN2 Rising Response Time (For XC6412B series) (Continued)

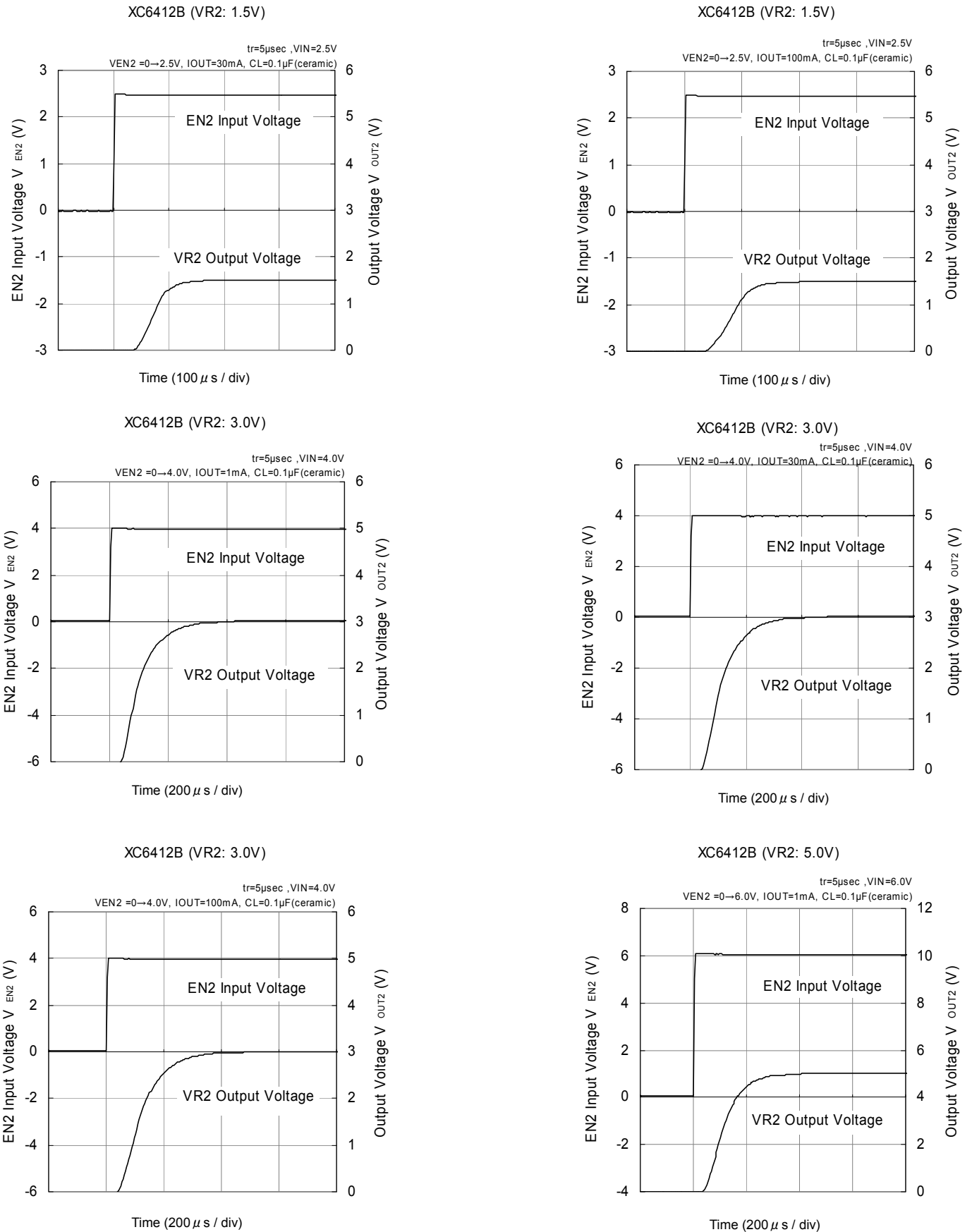

■ TYPICAL PERFORMANCE CHARACTERISTICS (Continued)

(11) EN2 Rising Response Time (For XC6412B series)

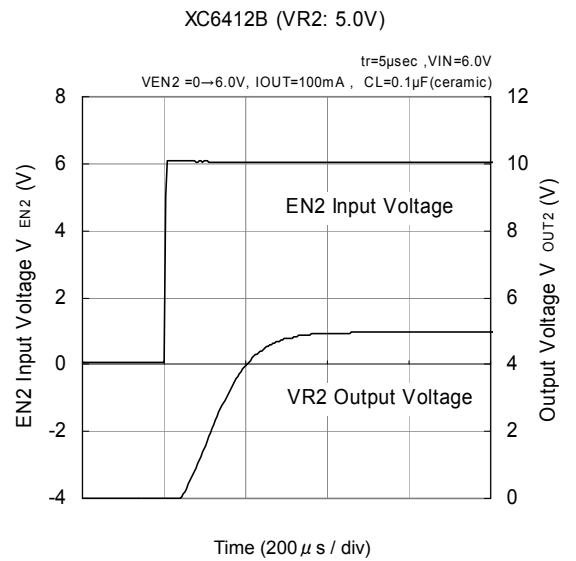
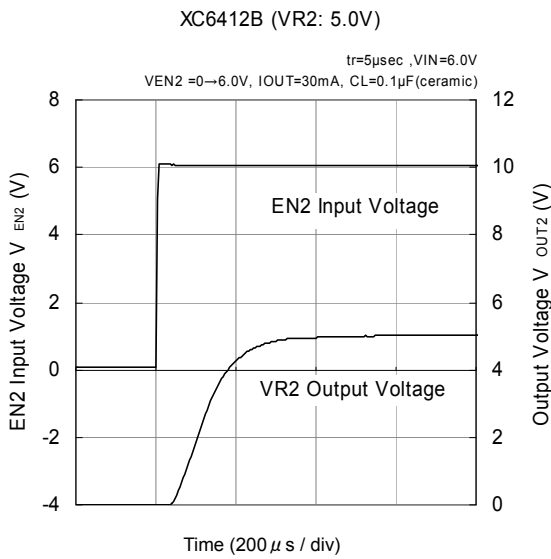

(12) Ripple Rejection Rate

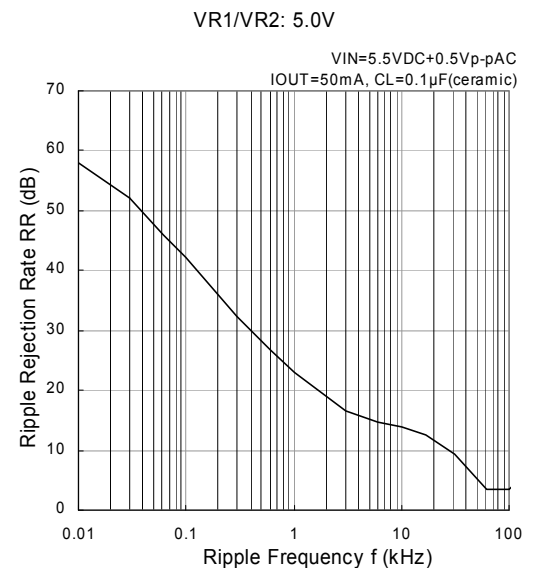
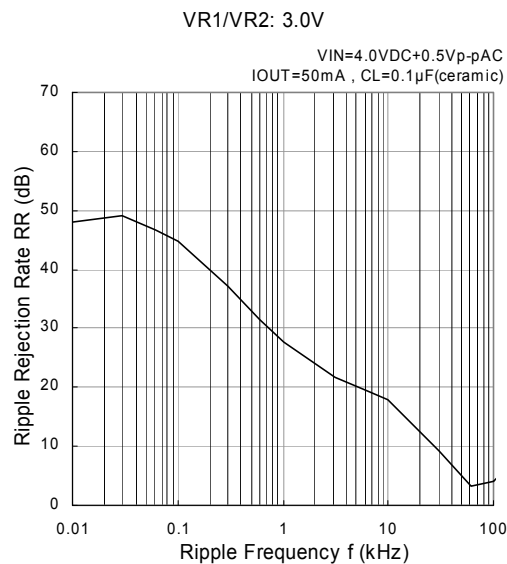
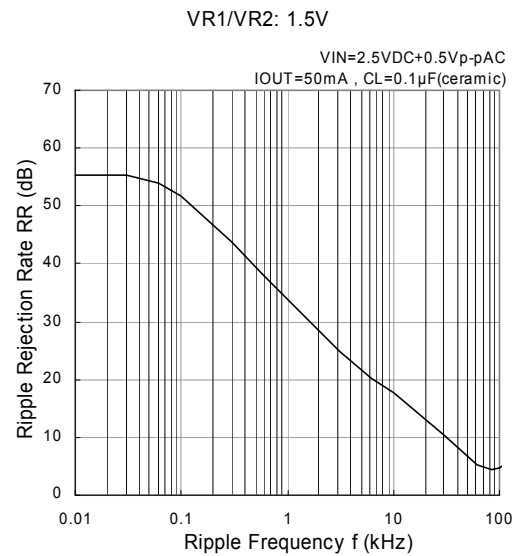
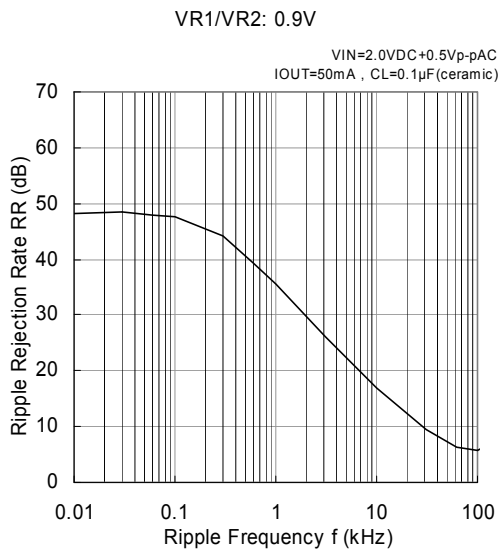

PACKAGING INFORMATION

● SOT-25

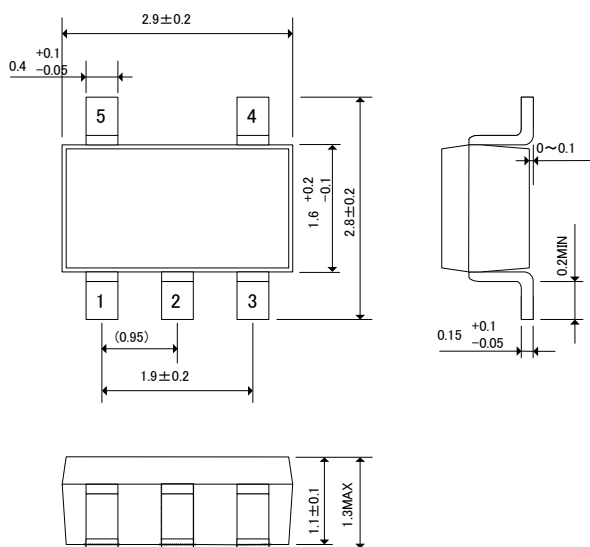

● SOT-26

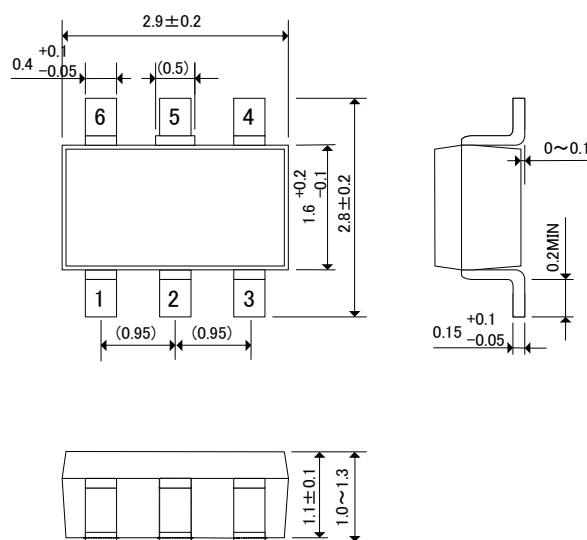

MARKING RULE

●SOT-25 (XC6411P), SOT-26 (XC6412B)

① represents product series

MARK	PRODUCT SERIES
P	XC6411P****-G
R	XC6412B****-G

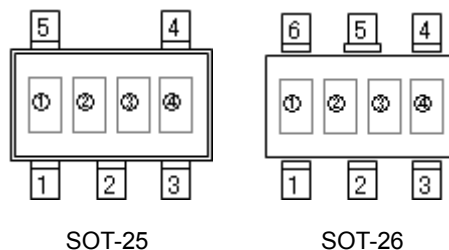

②③ represents internal sequential number

001, ..., 009, 010, ..., 099, 100, ..., 999 repeated.

MARK		NUMBERING RULE	PRODUCT SERIES
②	③		
0	1	001	XC641**001**-G
0	2	002	XC641**002**-G
0	D	003	XC641**003**-G
0	4	004	XC641**004**-G
0	5	005	XC641**005**-G
0	6	006	XC641**006**-G
0	7	007	XC641**007**-G
0	8	008	XC641**008**-G
0	9	009	XC641**009**-G
1	0	010	XC641**010**-G
1	1	011	XC641**011**-G
1	2	012	XC641**012**-G
1	D	013	XC641**013**-G
1	4	014	XC641**014**-G
1	5	015	XC641**015**-G
1	6	016	XC641**016**-G
1	7	017	XC641**017**-G
1	8	018	XC641**018**-G
1	9	019	XC641**019**-G
2	0	020	XC641**020**-G
2	1	021	XC641**021**-G
2	2	022	XC641**022**-G
2	D	023	XC641**023**-G

④ represents production lot number

0 to 9, A to Z reverse character 0 to 9, A to Z repeated

(G, I, J, O, Q, W excluded)