

Dual LDO Regulator with ON/OFF Switch

■ GENERAL DESCRIPTION

The XC6415 series is a highly accurate, CMOS Dual LDO voltage regulator. Performance features include low output noise, high ripple rejection rate, and low dropout. Extremely dense power supply circuit can be organized with a 2 channeled high speed voltage regulator in low ON resistance which is built-in to an ultra small USP-6C package.

The output voltage for each regulator is set independently by laser trimming and selectable in 0.05V increments within a range of 0.8 to 5.0V. The EN function allows the output of each regulator to be turned off independently. In this state, the electric charge at the output capacitor (C_L) will be discharged via the internal auto-discharge switch, and as a result the V_{OUT} pin quickly returns to the V_{SS} level.

The output stabilization capacitor (C_L) is also compatible with low ESR ceramic capacitors. The high level of output stability is maintained even during frequent load fluctuations, due to the excellent transient response performance. Because regulator 1 and 2 are completely isolated, a cross talk between each channel, which causes a problem during load fluctuations, can be greatly reduced.

■ APPLICATIONS

- Smart phones / Mobile phones
- Portable game consoles
- Digital still cameras / camcorders
- Digital audio equipment
- Mobile devices / terminals

■ FEATURES

Output Current	: 200mA (300mA limit, TYP.)
Dropout Voltage	: 95mV @ $I_{OUT}=100mA$ $V_{OUT}=3.0V$
Operating Voltage Range	: 1.5V ~ 6.0V
Output Voltage Range	: 0.8V ~ 5.0V (0.05V increments)
High Accuracy	: $\pm 1\%$ @ $V_{OUT}>2.0V$ $\pm 2\%$ @ $V_{OUT}\geq 1.5V$ $\pm 20mV$ @ $V_{OUT}\leq 2.0V$ $\pm 30mV$ @ $V_{OUT}< 1.5V$
Low Power Consumption	: 28 μA /ch (TYP.)
Stand-by Current	: Less than 0.1 μA
Ripple Rejection	: 65dB@1kHz
Operating Ambient Temperature	: -40°C ~ 85°C
Low ESR Capacitor	: 1.0 μF ceramic capacitors
Packages	: USP-6C, SOT-26, USPN-6
Environmentally Friendly	: EU RoHS Compliant, Pb Free

■ TYPICAL APPLICATION CIRCUITS



■ TYPICAL PERFORMANCE CHARACTERISTICS

● Cross Talk

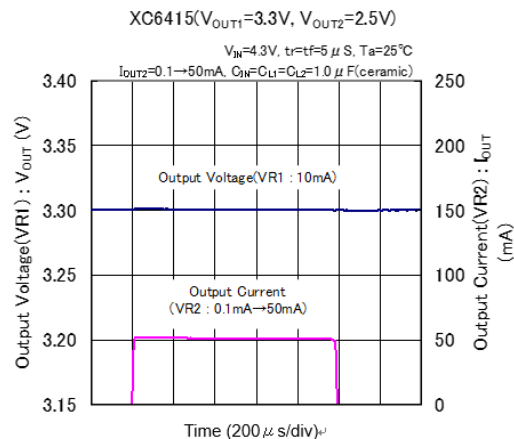

■ BLOCK DIAGRAMS

XC6415 Series AA/CC Type

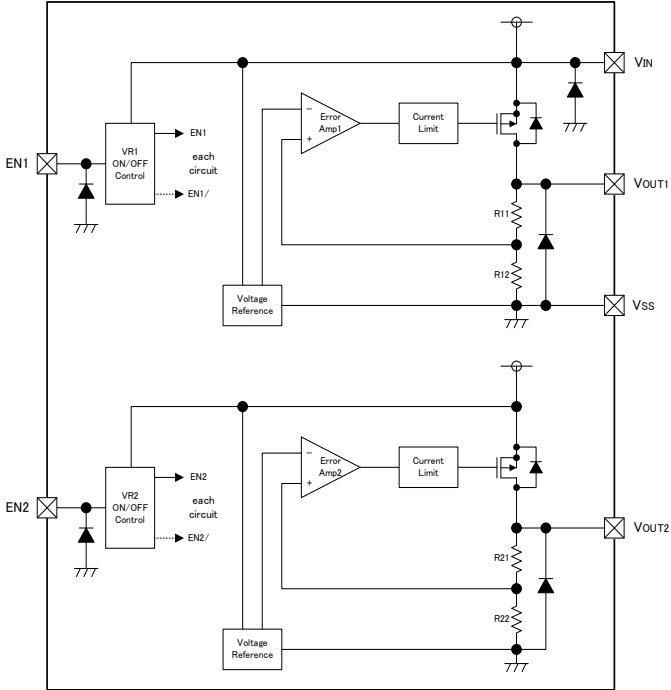

XC6415 Series AB/CD Type

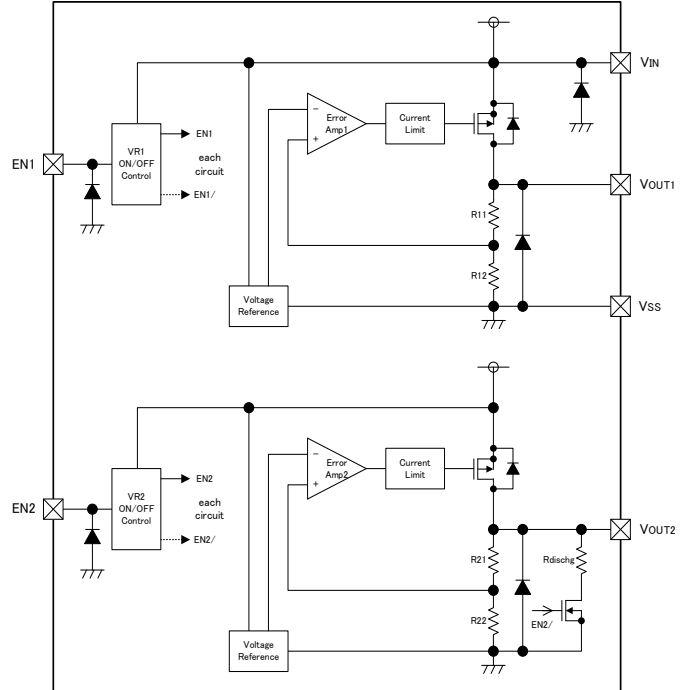

XC6415 Series BB/DD Type

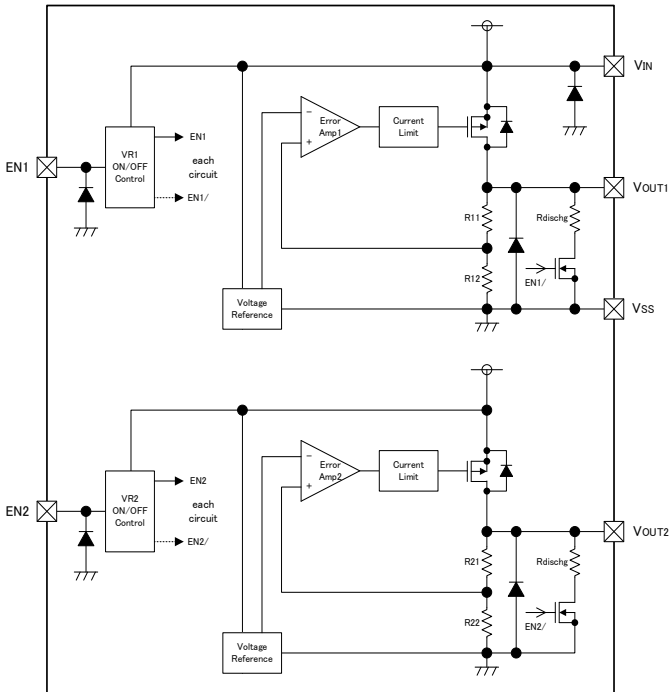

XC6415 Series BA/DC Type

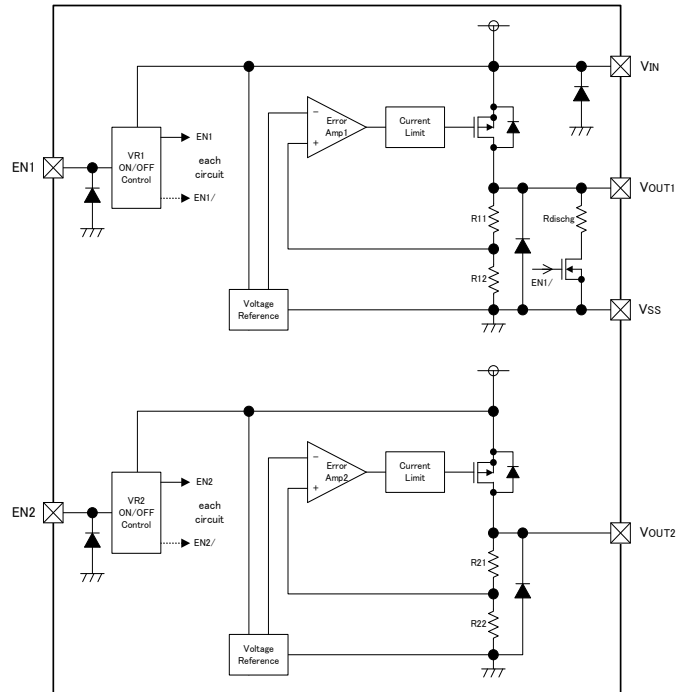

* Diodes inside the circuits are ESD protection diodes and parasitic diodes.

■ BLOCK DIAGRAMS

XC6415 Series EE/GG Type



XC6415 Series EF/GH Type



XC6415 Series FF/HH Type



XC6415 Series FE/HG Type



* Diodes inside the circuits are ESD protection diodes and parasitic diodes.

■ PRODUCT CLASSIFICATION

● Ordering Information

XC6415①②③④⑤⑥-⑦

DESIGNATOR	DESCRIPTION	SYMBOL	DESCRIPTON
①	Type of Regulator 1 (All EN High Active)	A	Refer to Selection Guide
		B	
		C	
		D	
		E	
		F	
		G	
		H	
②	Type of Regulator 2 (All EN High Active)	A	
		B	
		C	
		D	
		E	
		F	
		G	
		H	
③④	Output Voltage	01~	
⑤⑥-⑦ ^(*)	Packages (Order Unit)	MR-G	SOT-26 (3,000 pcs/Reel)
		MR	SOT-26 (3,000 pcs/Reel)
		ER-G	USP-6C (3,000 pcs/Reel)
		ER	USP-6C (3,000 pcs/Reel)
		7R-G	USPN-6 (5,000 pcs/Reel)

^(*) The "-G" suffix indicates that the products are Halogen and Antimony free as well as being fully EU RoHS compliant.

● Selection Guide

TYPE①/②	CURRENT LIMITTER	CE PULL-DOWN RESISTOR	CL AUTO-DISCHARGE	OUTPUT VOLTAGE ACCURACY
A	Yes	No	No	±1%
B	Yes	No	Yes	±1%
C	Yes	No	No	±2%
D	Yes	No	Yes	±2%
E	Yes	Yes	No	±1%
F	Yes	Yes	Yes	±1%
G	Yes	Yes	No	±2%
H	Yes	Yes	Yes	±2%

■ PRODUCT CLASSIFICATION (Continued)

DESIGNATOR

③④	VR1	VR2	③④	VR1	VR2	③④	VR1	VR2	③④	VR1	VR2
01	1.80	2.80	41	2.80	3.00	81	2.00	3.30	C1	3.30	2.50
02	1.20	2.90	42	2.90	1.80	82	3.30	2.00	C2	1.85	2.85
03	1.80	1.80	43	3.00	1.80	83	2.80	1.20	C3	1.50	2.90
04	1.50	2.70	44	2.50	1.80	84	1.00	3.30	C4	1.80	3.20
05	2.85	2.85	45	1.80	2.85	85	2.70	2.70	C5	1.00	2.50
06	1.80	3.30	46	1.50	1.20	86	2.70	3.30	C6	3.10	2.80
07	3.00	3.00	47	2.85	1.50	87	2.90	2.90	C7	3.00	3.60
08	2.80	1.80	48	3.20	3.20	88	2.50	2.80	C8	1.30	3.00
09	1.20	1.20	49	1.20	3.00	89	2.50	3.00	C9	1.50	2.40
10	1.10	1.30	50	2.60	2.85	90	4.50	4.50	D0	3.30	3.60
11	1.30	1.50	51	4.20	3.10	91	3.30	5.00	D1	1.00	2.85
12	2.80	2.80	52	5.00	3.60	92	3.00	5.00	D2	1.80	1.85
13	2.50	3.30	53	1.80	1.20	93	1.80	2.90	D3	3.60	1.50
14	3.00	3.30	54	2.60	3.00	94	1.10	1.80	D4	3.00	2.80
15	1.20	1.80	55	2.60	2.60	95	1.20	1.30	D5	4.50	2.60
16	2.80	3.30	56	1.80	2.60	96	1.00	1.20	D6	2.00	1.80
17	3.30	3.30	57	2.60	3.30	97	1.50	2.50	D7	3.30	3.10
18	3.10	3.10	58	2.50	2.90	98	1.20	0.90	D8	3.20	3.10
19	2.80	1.50	59	1.80	2.70	99	3.15	3.15	D9	3.40	3.10
20	1.30	2.80	60	1.00	2.80	A0	3.10	1.80	E0	3.10	2.50
21	1.50	2.80	61	3.00	1.50	A1	1.80	2.00	E1	2.50	3.10
22	1.80	3.00	62	2.70	1.80	A2	1.50	1.30	E2	3.40	3.40
23	1.85	2.80	63	2.80	2.70	A3	2.85	2.60	E3	1.00	1.80
24	1.85	3.30	64	2.80	3.10	A4	1.25	2.50	E4	1.30	3.30
25	2.60	2.80	65	2.85	3.30	A5	1.85	1.20	E5	2.60	2.70
26	1.50	1.50	66	1.20	3.30	A6	3.30	1.20	E6	1.35	1.80
27	2.00	3.00	67	2.80	2.50	A7	1.80	1.95	E7	1.85	2.65
28	3.30	1.80	68	2.85	1.20	A8	2.85	3.00	E8	1.90	3.00
29	3.30	1.75	69	2.75	2.75	A9	1.55	2.80	E9	4.20	3.00
30	2.10	4.10	70	3.00	2.90	B0	1.90	1.90	F0	1.70	3.00
31	1.20	2.80	71	3.00	2.95	B1	2.50	2.85	F1	1.10	1.90
32	1.50	1.80	72	3.00	3.05	B2	3.00	1.00	F2	1.25	2.80
33	1.50	3.00	73	3.10	2.90	B3	1.30	1.80	F3	4.50	1.80
34	1.50	3.30	74	3.10	2.95	B4	2.70	3.00	F4	0.80	2.80
35	1.50	2.60	75	3.10	3.00	B5	2.80	1.90	F5	2.80	5.00
36	2.00	2.50	76	3.10	3.05	B6	2.50	0.90			
37	3.30	4.50	77	3.00	3.10	B7	3.15	2.85			
38	2.50	2.50	78	1.20	2.60	B8	2.60	1.30			
39	1.80	2.50	79	3.50	3.50	B9	3.00	2.50			
40	1.20	2.50	80	1.10	1.50	C0	3.30	1.10			

*For other output voltage combinations, please contact your local Torex sales office or representative.

PIN CONFIGURATION



SOT-26
(TOP VIEW)

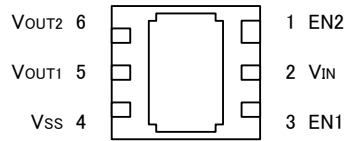

USP-6C*
(BOTTOM VIEW)

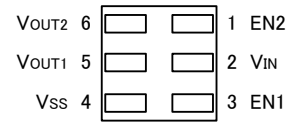

USPN-6
(BOTTOM VIEW)

*The dissipation pad for the USP-6C package should be solder-plated in recommended mount pattern and metal masking so as to enhance mounting strength and heat release. If the pad needs to be connected to other pins, it should be connected to the V_{SS} (No. 4) pin.

PIN ASSIGNMENT

PIN NUMBER			PIN NAME	FUNCTIONS
SOT-26	USP-6C	USPN-6		
1	3	3	EN1	ON/OFF Control 1
2	2	2	V _{IN}	Power Input
3	1	1	EN2	ON/OFF Control 2
4	6	6	V _{OUT2}	Output 2
5	4	4	V _{SS}	Ground
6	5	5	V _{OUT1}	Output 1

PIN FUNCTIOS ASSIGNMENT

XC6415 Series A/B/C/D Type

PIN NAME	SIGNAL	STATUS
EN	H	Active
	L	Stand-by
	OPEN	Unstable

XC6415 Series E/F/G/H Type

PIN NAME	SIGNAL	STATUS
EN	H	Active
	L	Stand-by
	OPEN	Stand-by

■ ABSOLUTE MAXIMUM RATINGS

PARAMETER		SYMBOL	RATINGS	UNITS
Input Voltage		V_{IN}	-0.3 ~ + 6.5	V
Output Current		$I_{OUT1} + I_{OUT2}$	500 ⁽¹⁾	mA
Output Voltage 1 / Output Voltage 2		V_{OUT1} / V_{OUT2}	$V_{SS} - 0.3 \sim V_{IN} + 0.3$	V
EN1/EN2 Input Voltage		V_{EN1} / V_{EN2}	$V_{SS} - 0.3 \sim + 6.5$	V
Power Dissipation ($T_a=25^\circ\text{C}$)	SOT-26	Pd	250	mW
			600 (40mm x 40mm Standard board) ⁽²⁾	
	USP-6C		100	
			1000 (40mm x 40mm Standard board) ⁽²⁾	
	USPN-6		1250 (JESD51-7 board) ⁽²⁾	
			600 (40mm x 40mm Standard board) ⁽²⁾	
Operating Ambient Temperature		T_{opr}	-40 ~ + 85	°C
Storage Temperature		T_{stg}	-55 ~ + 125	°C

Each rating voltage is based on the V_{SS}

⁽¹⁾Please use within the range of $Pd > \{ (V_{IN}-V_{OUT1}) \times I_{OUT1} + (V_{IN}-V_{OUT2}) \times I_{OUT2} \}$

⁽²⁾The power dissipation figure shown is PCB mounted and is for reference only.

The mounting condition is please refer to PACKAGING INFORMATION.

ELECTRICAL CHARACTERISTICS

● XC6415 Series

Regulator 1, Regulator 2

Ta=25°C

PARAMETER	SYMBOL	CONDITIONS	MIN.	TYP.	MAX.	UNITS	CIRCUITS	
Output Voltage	V _{OUT(E)} ^{(*)2}	V _{OUT(T)} ≥ 2.0V, V _{EN} =V _{IN} , I _{OUT} =10mA (A, B, E, F type)	×0.99 (*)3	V _{OUT(T)} (*)4	×1.01 (*)3	V	①	
		V _{OUT} ≤ 1.95V, V _{EN} =V _{IN} , I _{OUT} =10mA (A, B, E, F type)	-0.02 (*)3		+0.02 (*)3			
		V _{OUT(T)} ≥ 1.5V V _{EN} =V _{IN} , I _{OUT} =10mA (C, D, G, H type)	×0.98 (*)3		×1.02 (*)3			
		V _{OUT} ≤ 1.45V V _{EN} =V _{IN} , I _{OUT} =10mA (C, D, G, H type)	-0.03 (*)3		+0.03 (*)3			
Output Current	I _{OUTMAX}		200	-	-	mA	①	
Load Regulation	ΔV _{OUT}	V _{EN} =V _{IN} , 0.1mA ≤ I _{OUT} ≤ 100mA	E-1			mV	①	
Dropout Voltage ^{(*)5}	V _{dif}	I _{OUT} =100mA, V _{EN} =V _{IN}	E-2			mV	①	
Supply Current	I _{SS}	V _{IN} =V _{EN} =V _{OUT(T)} + 1.0V, I _{OUT} =0mA	-	(A, B, C, D type)	28	60	μA	②
		(E, F, G, H type)		28	65			
Stand-by Current	I _{STBY}	V _{IN} =6.0V, V _{EN} =V _{SS}	-	0.01	0.10	μA	②	
Line Regulation	ΔV _{OUT} / (ΔV _{IN} ·V _{OUT})	V _{OUT(T)} +0.5V ≤ V _{IN} ≤ 6.0V : V _{OUT(T)} ≥ 1.0V, V _{EN} =V _{IN} , I _{OUT} =10mA	-	0.01	0.20	%V	①	
		1.5V ≤ V _{IN} ≤ 6.0V : V _{OUT(T)} ≤ 0.95V V _{EN} =V _{IN} , I _{OUT} =10mA						
Input Voltage	V _{IN}		1.5	-	6.0	V	①	
Output Voltage Temperature Characteristics	ΔV _{OUT} / (ΔTa·V _{OUT})	V _{EN} =V _{IN} , I _{OUT} =30mA -40°C ≤ Ta ≤ 85°C	-	±100	-	ppm/°C	①	
Ripple Rejection Rate	PSRR	V _{IN} ={V _{OUT(T)} +1.0}V _{DC} +0.5Vp-pAC : V _{OUT(T)} ≤ 4.75V, V _{EN} =V _{IN} , I _{OUT} =30mA, f=1kHz	-	65	-	dB	③	
		V _{IN} =5.75V _{DC} +0.5Vp-pAC : V _{OUT(T)} ≥ 4.8V, V _{EN} =V _{IN} , I _{OUT} =30mA, f=1kHz						
Limit Current	I _{LIM}	V _{EN} =V _{IN}	210	300	-	mA	①	
Short Current	I _{SHORT}	V _{EN} =V _{IN} , Short V _{OUT} to V _{SS} level	-	20	-	mA	①	
EN "H" Level Voltage	V _{ENH}		1.2	-	6.0	V	①	
EN "L" Level Voltage	V _{ENL}		-	-	0.3	V	①	
EN "H" Level Current	I _{ENH}	V _{EN} =V _{IN} (A, B, C, D type)	-0.1	-	0.1	μA	①	
		V _{EN} =V _{IN} =6V (E, F, G, H type) ^{(*)10}	-	3.0	-			
EN "L" Level Current	I _{ENL}	V _{EN} =V _{SS}	-0.1	-	0.1	μA	①	
C _L Discharge Resistor ^{(*)8}	R _{DCHG}	V _{IN} =6.0V, V _{OUT} =4.0V, V _{CE} =V _{SS}	-	550	-	Ω	①	

NOTE:

(*)1 Unless otherwise stated, V_{IN}=V_{OUT(T)}+1.0V.

(*)2 V_{OUT(E)}= Effective output voltage (see the voltage chart)

(ie. The output voltage when "V_{OUT(T)}+1.0V" is provided at the V_{IN} pin while maintaining a certain I_{OUT} value.

(*)3 Characteristics of the actual V_{OUT(E)} by setting output voltage is shown in the voltage chart.

(*)4 V_{OUT(T)}: Nominal output voltage

(*)5 V_{dif}={V_{IN1}^{(*)7} - V_{OUT1}^{(*)6}}

(*)6 V_{OUT1}: A voltage equal to 98% of the output voltage whenever an amply stabilized I_{OUT}{V_{OUT(T)}+1.0V} is input.

(*)7 V_{IN1}: The input voltage when V_{OUT1} appears as input voltage is gradually decreased.

(*)8 For XC6415B, D, F, H series only.

XC6415A, C, E, G series discharge with only Rx1 and Rx2 resistors as shown in the BLOCK DIAGRAMS.

(*)9 Each channel is measured when the other channel is turned off (V_{EN}=V_{SS}).

(*)10 XC6415E, F, G, H type only. (Including the current flowing through the pull down resistor.)

■ ELECTRICAL CHARACTERISTICS (Continued)

● Voltage Chart

NOMINAL OUTPUT VOLTAGE	OUTPUT VOLTAGE ±1%		OUTPUT VOLTAGE ±2%		LOAD REGULATION E-1		DROPOUT VOLTAGE E-2	
	(V)		(V)		(mV)		(mV)	
	V _{OUT(E)}		V _{OUT(E)}		ΔV _{OUT}		V _{dif}	
V _{OUT(T)}	MIN.	MAX.	MIN.	MAX.	TYP.	MAX.	TYP.	MAX.
0.80	0.7800	0.8200	0.7700	0.8300	10	30	500	850
0.85	0.8300	0.8700	0.8200	0.8800				
0.90	0.8800	0.9200	0.8700	0.9300				
0.95	0.9300	0.9700	0.9200	0.9800			410	750
1.00	0.9800	1.0200	0.9700	1.0300				
1.05	1.0300	1.0700	1.0200	1.0800			360	600
1.10	1.0800	1.1200	1.0700	1.1300				
1.15	1.1300	1.1700	1.1200	1.1800			330	600
1.20	1.1800	1.2200	1.1700	1.2300				
1.25	1.2300	1.2700	1.2200	1.2800			280	420
1.30	1.2800	1.3200	1.2700	1.3300				
1.35	1.3300	1.3700	1.3200	1.3800			240	360
1.40	1.3800	1.4200	1.3700	1.4300				
1.45	1.4300	1.4700	1.4200	1.4800			200	300
1.50	1.4800	1.5200	1.4700	1.5300				
1.55	1.5300	1.5700	1.5190	1.5810			180	260
1.60	1.5800	1.6200	1.5680	1.6320				
1.65	1.6300	1.6700	1.6170	1.6830			170	240
1.70	1.6800	1.7200	1.6660	1.7340				
1.75	1.7300	1.7700	1.7150	1.7850	150	200		
1.80	1.7800	1.8200	1.7640	1.8360				
1.85	1.8300	1.8700	1.8130	1.8870				
1.90	1.8800	1.9200	1.8620	1.9380				
1.95	1.9300	1.9700	1.9110	1.9890				
2.00	1.9800	2.0200	1.9600	2.0400				
2.05	2.0295	2.0705	2.0090	2.0910				
2.10	2.0790	2.1210	2.0580	2.1420				
2.15	2.1285	2.1715	2.1070	2.1930				
2.20	2.1780	2.2220	2.1560	2.2440				
2.25	2.2275	2.2725	2.2050	2.2950	120	180		
2.30	2.2770	2.3230	2.2540	2.3460				
2.35	2.3265	2.3735	2.3030	2.3970				
2.40	2.3760	2.4240	2.3520	2.4480				
2.45	2.4255	2.4745	2.4010	2.4990				
2.50	2.4750	2.5250	2.4500	2.5500				
2.55	2.5245	2.5755	2.4990	2.6010				
2.60	2.5740	2.6260	2.4580	2.6520				
2.65	2.6235	2.6765	2.8970	2.7030	110	150		
2.70	2.6730	2.7270	2.6460	2.7540				
2.75	2.7225	2.7775	2.6950	2.8050				
2.80	2.7720	2.8280	2.7440	2.8560				
2.85	2.8215	2.8785	2.7930	2.9070	95	150		
2.90	2.8710	2.9290	2.8420	2.9580				
2.95	2.9205	2.9795	2.8910	3.0090				

■ ELECTRICAL CHARACTERISTICS (Continued)

● Voltage Chart (Continued)

NOMINAL OUTPUT VOLTAGE	OUTPUT VOLTAGE ±1%		OUTPUT VOLTAGE ±2%		LOAD REGULATION E-1		DROPOUT VOLTAGE E-2	
	(V)		(V)		(mV)		(mV)	
V _{OUT(T)}	V _{OUT(E)}		V _{OUT(E)}		ΔV _{OUT}		V _{dif}	
	MIN.	MAX.	MIN.	MAX.	TYP.	MAX.	TYP.	MAX.
3.00	2.9700	3.0300	2.9400	3.0600	20	50	95	150
3.05	3.0195	3.0805	2.9890	3.1110				
3.10	3.0690	3.1310	3.0380	3.1620				
3.15	3.1185	3.1815	3.0870	3.2130				
3.20	3.1680	3.2320	3.1360	3.2640				
3.25	3.2175	3.2825	3.1850	3.3150				
3.30	3.2670	3.3330	3.2340	3.3660				
3.35	3.3165	3.3835	3.2830	3.4170				
3.40	3.3660	3.4340	3.3320	3.4680				
3.45	3.4155	3.4845	3.3810	3.5190				
3.50	3.4650	3.5350	3.4300	3.5700				
3.55	3.5145	3.5855	3.4790	3.6210				
3.60	3.5640	3.6360	3.5280	3.6720				
3.65	3.6135	3.6865	3.5770	3.7230				
3.70	3.6630	3.7370	3.6260	3.7740				
3.75	3.7125	3.7875	3.6750	3.8250				
3.80	3.7620	3.8380	3.7240	3.8760				
3.85	3.8115	3.8885	3.7730	3.9270				
3.90	3.8610	3.9390	3.8220	3.9780				
3.95	3.9105	3.9895	3.8710	4.0290				
4.00	3.9600	4.0400	3.9200	4.0800	30	60	80	120
4.05	4.0095	4.0905	3.9690	4.1310				
4.10	4.0590	4.1410	4.0180	4.1820				
4.15	4.1085	4.1915	4.0670	4.2330				
4.20	4.1580	4.2420	4.1160	4.2840				
4.25	4.2075	4.2925	4.1650	4.3350				
4.30	4.2570	4.3430	4.2140	4.3860				
4.35	4.3065	4.3935	4.2630	4.4370				
4.40	4.3560	4.4440	4.3120	4.4880				
4.45	4.4055	4.4945	4.3610	4.5390				
4.50	4.4550	4.5450	4.4100	4.5900				
4.55	4.5045	4.5955	4.4590	4.6410				
4.60	4.5540	4.6460	4.5080	4.6920				
4.65	4.6035	4.6965	4.5570	4.7430				
4.70	4.6530	4.7470	4.6060	4.7940				
4.75	4.7025	4.7975	4.6550	4.8450				
4.80	4.7520	4.8480	4.7040	4.8960				
4.85	4.8015	4.8985	4.7530	4.9470				
4.90	4.8510	4.9490	4.8020	4.9980				
4.95	4.9005	4.9995	4.8510	5.0490				
5.00	4.9500	5.0500	4.9000	5.1000				

TEST CIRCUITS

● Circuit ①



● Circuit ②



● Circuit ③



OPERATIONAL DESCRIPTION

<Output Voltage Control>

The voltage divided by resistors Rx1 and Rx2 is compared with the internal reference voltage by the error amplifier. The P-channel MOSFET which is connected to the V_{OUT} pin is then driven by the subsequent output signal. The output voltage at the V_{OUT} pin is controlled and stabilized by a system of negative feedback. The current limit circuit and short protect circuit operate in relation to the level of output current. Further, the IC's internal circuitry can be shutdown via the EN pin's signal.



< XC6415BB Series >

<C_L Auto-Discharge Function>

XC6415B, D, F, H series can quickly discharge the electric charge at the output capacitor (C_L), when a low signal to the EN pin, which enables a whole IC circuit put into OFF state, is inputted via the N-channel transistor located between the V_{OUT} pin and the V_{SS} pin (cf. BLOCK DIAGRAM). The C_L discharge resistance is set to 550Ω when V_{IN} is 6.0V (TYP.) and V_{OUT} is 4.0V (TYP.). Moreover, discharge time of the output capacitor (C_L) is set by the C_L auto-discharge resistance (R) and the output capacitor (C_L). By setting time constant of a C_L auto-discharge resistance value [R] and an output capacitor value (C_L) as τ(τ=C x R), the output voltage after discharge via the N channel transistor is calculated by the following formulas.

$$V = V_{OUT} \times e^{-t/\tau}, \quad \text{or } t = \tau \ln(V_{OUT(E)} / V)$$

(V : Output voltage after discharge, V_{OUT(E)} : Output voltage, t: Discharge time,
τ : C_L auto-discharge resistance R × Output capacitor (C_L) value C)

C_L high-speed discharge function can be set by each regulator.

<Current Limiter, Short-Circuit Protection>

The XC6415 series includes a fold-back circuit, which aid the operations of the current limiter and circuit protection. When the load current reaches the current limit level, the fold-back circuit operates and output voltage drops. As a result of this drop in output voltage, output current also decreases. When the output pin is shorted, a current of about 20mA flows.

<EN Pin>

The IC's internal circuitry can be shutdown via the signal from the EN pin with the XC6415 series. In shutdown mode, output at the V_{OUT} pin will be pulled down to the V_{SS} level via Rx1 & Rx2. However, as for the XC6415B, D, F, H series, the C_L auto-discharge resistor is connected in parallel to Rx1 and Rx2 while the power supply is applied to the V_{IN} pin. Therefore, time until the V_{OUT} pin reaches the V_{SS} level becomes short. The EN pin is CMOS input, but in case the EN pin with pulled down resistor, the EN input current will be increase when the IC operates. Also, in case of the EN pin without pulled down resistor, the output voltage becomes unstable when the EN pin is left open. If this IC is used with the correct output voltage for the EN pin, the logic is fixed and the IC will operate normally. However, supply current may increase as a result of through current in the IC's internal circuitry when medium voltage is input.

NOTES ON USE

1. Please use this IC within the stated absolute maximum ratings. The IC is liable to malfunction should the ratings be exceeded.
2. Where wiring impedance is high, operations may become unstable due to noise and/or phase lag depending on output current. Please wire the input capacitor (C_{IN}) and the output capacitor (C_L) as close to the IC as possible.
3. Torex places an importance on improving our products and its reliability.
However, by any possibility, we would equest user fail-safe design and post-aging treatment on system or equipment.

TYPICAL PERFORMANCE CHARACTERISTICS

* EN Voltage condition: Unless otherwise stated, $V_{EN}=V_{IN}$

(1) OutputVoltage vs. OutputCurrent

XC6415($V_{OUT}=0.8V$)



XC6415($V_{OUT}=0.8V$)



XC6415($V_{OUT}=1.5V$)



XC6415($V_{OUT}=1.5V$)



XC6415($V_{OUT}=2.8V$)

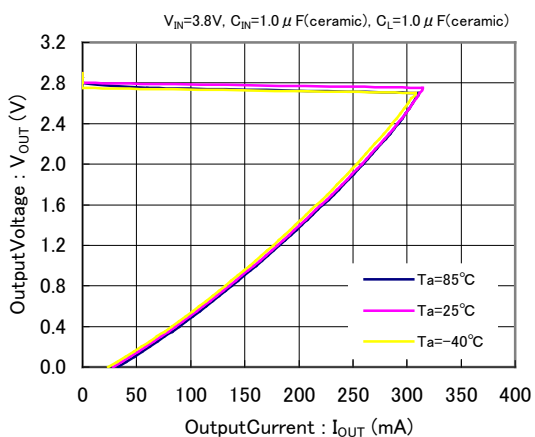

XC6415($V_{OUT}=2.8V$)



TYPICAL PERFORMANCE CHARACTERISTICS (Continued)

(1) OutputVoltage vs. OutputCurrent (Continued)



(2) OutputVoltage vs. InputVoltage

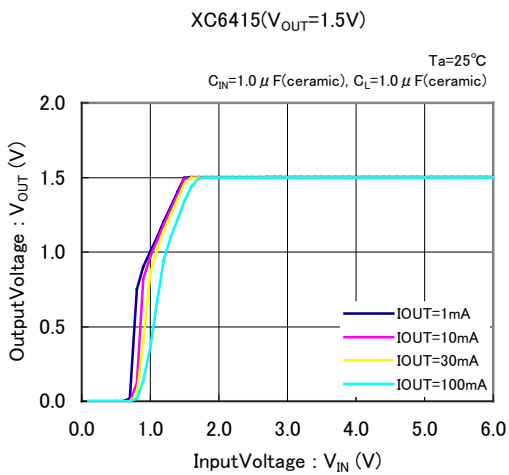

■ TYPICAL PERFORMANCE CHARACTERISTICS (Continued)

(2) OutputVoltage vs. InputVoltage (Continued)

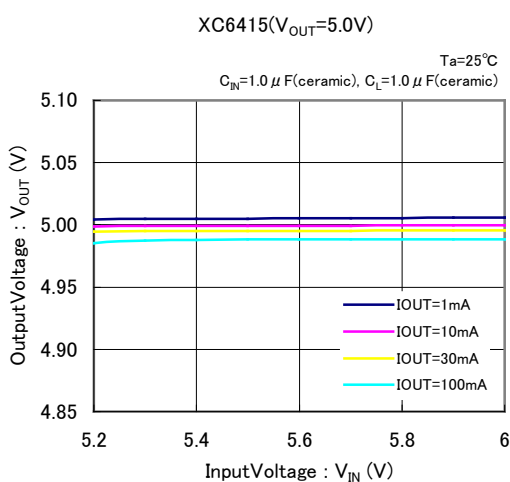
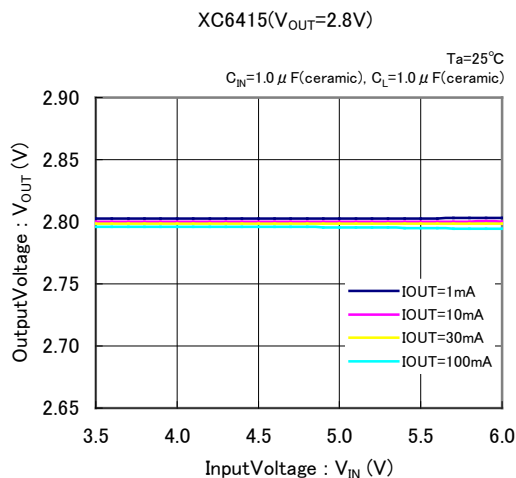

(3) DropoutVoltage vs. OutputCurrent

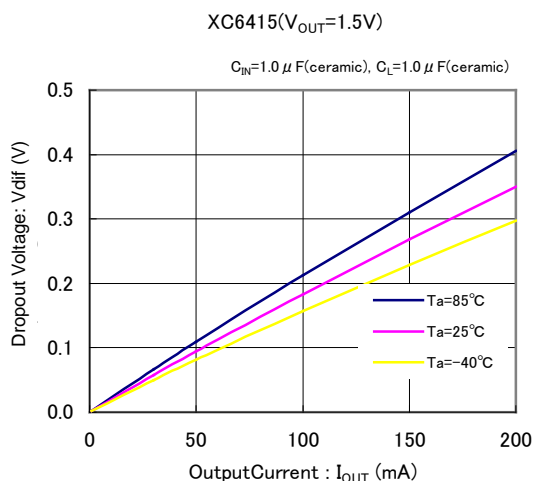
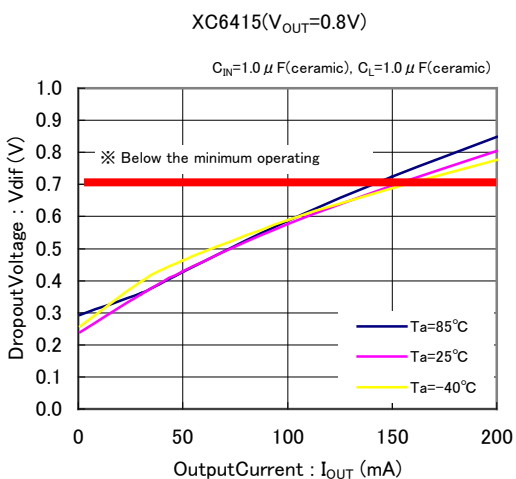

TYPICAL PERFORMANCE CHARACTERISTICS (Continued)

(3) Dropout Voltage vs. Output Current (Continued)

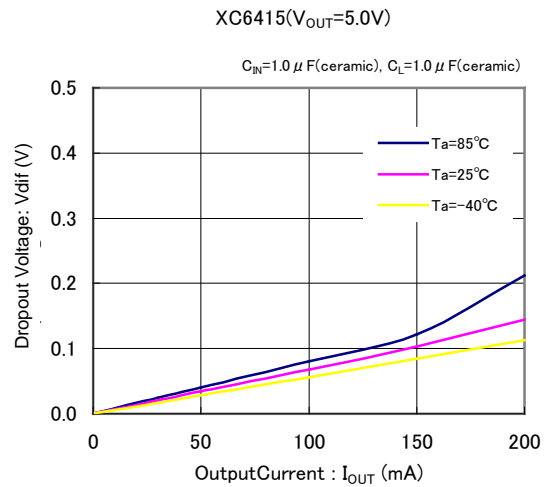
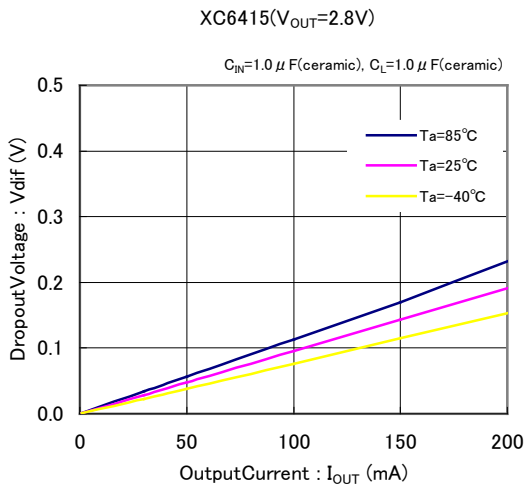

(4) Supply Current vs. Input Voltage

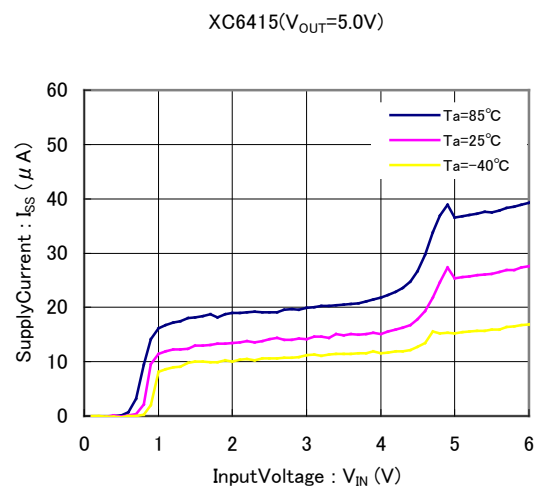
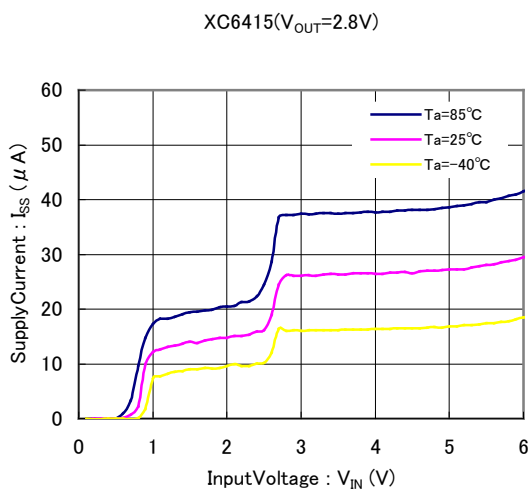
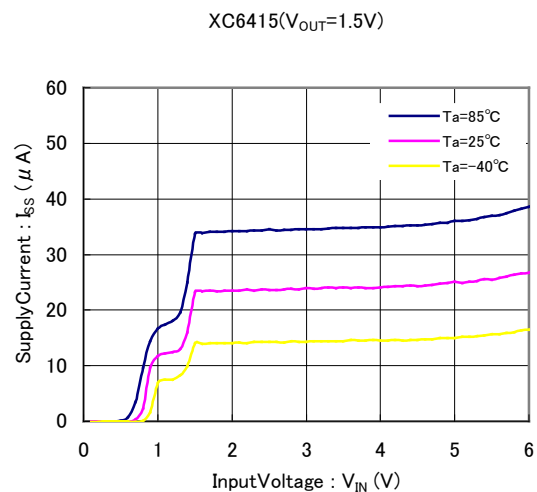
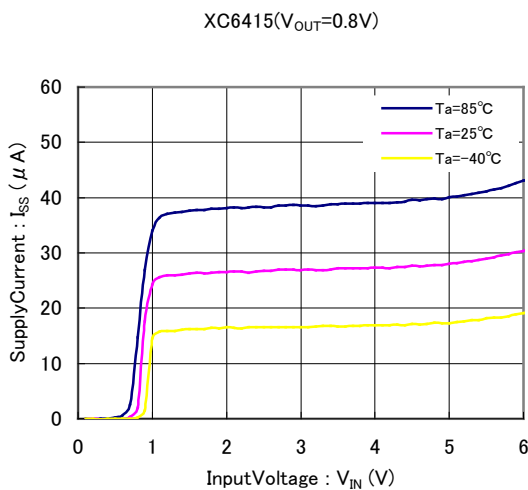

TYPICAL PERFORMANCE CHARACTERISTICS (Continued)

(5) Output Voltage vs. Ambient Temperature



(6) Supply Current vs. Ambient Temperature

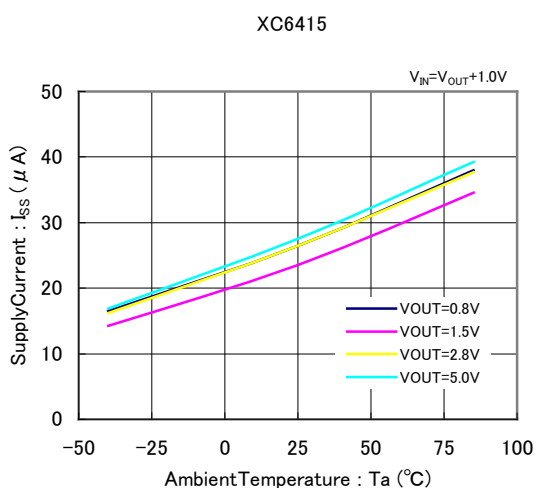

(7) EN Threshold Voltage vs. Ambient Temperature

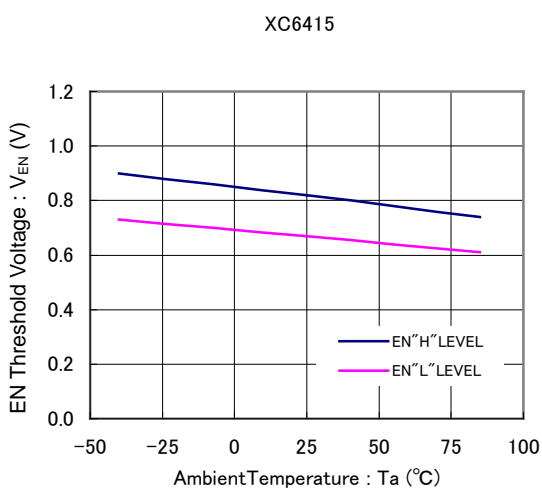

TYPICAL PERFORMANCE CHARACTERISTICS (Continued)

(8) Rising Response Time



(9) Input Transient Response



■ TYPICAL PERFORMANCE CHARACTERISTICS (Continued)

(9) Input Transient Response (Continued)



(10) Load Transient Response

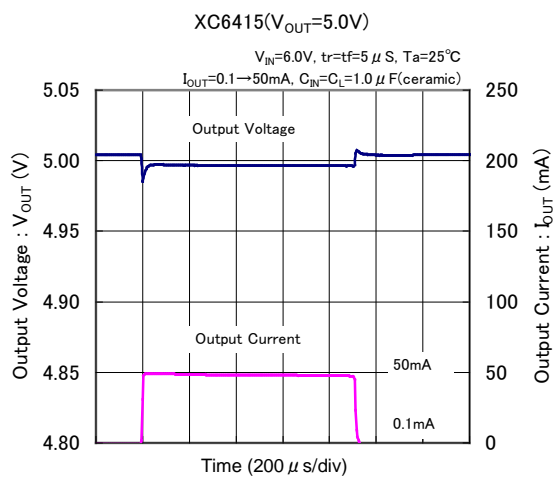
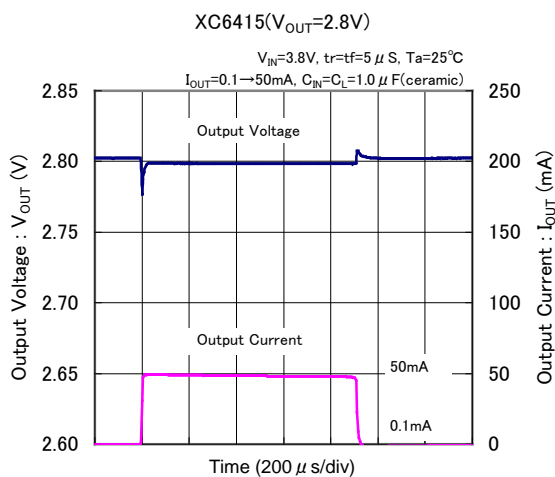
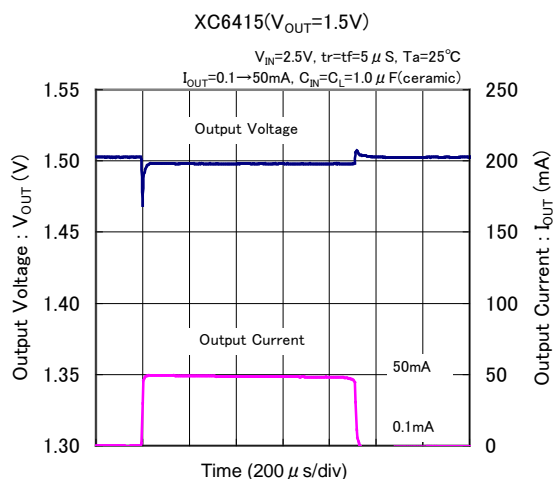
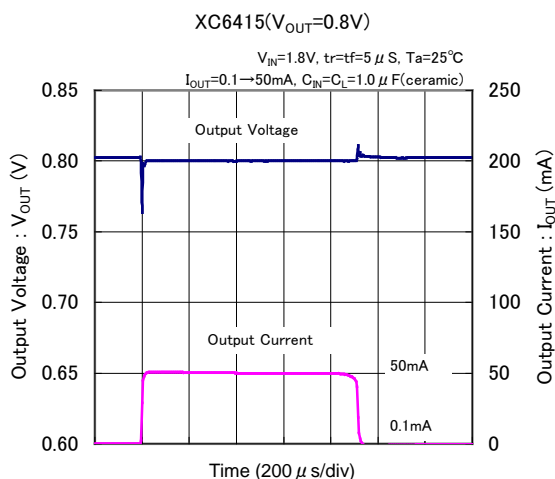

TYPICAL PERFORMANCE CHARACTERISTICS (Continued)

(11) EN Rising Respose Time

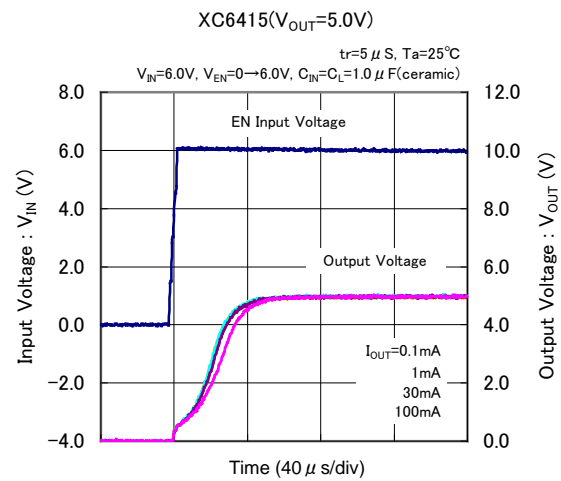
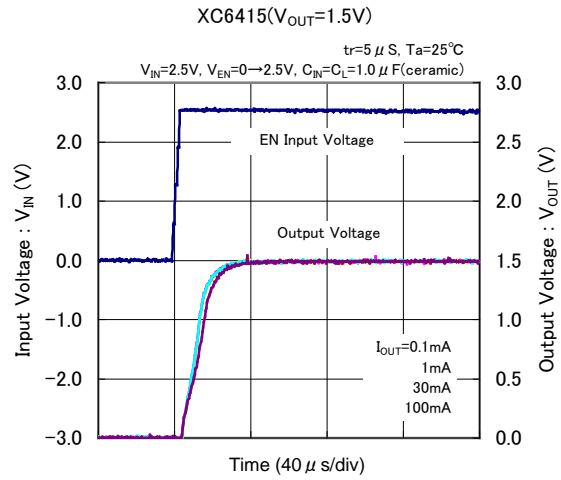

(12) Ripple Rejection Rate



■ TYPICAL PERFORMANCE CHARACTERISTICS (Continued)

(12) Ripple Rejection Rate (Continued)

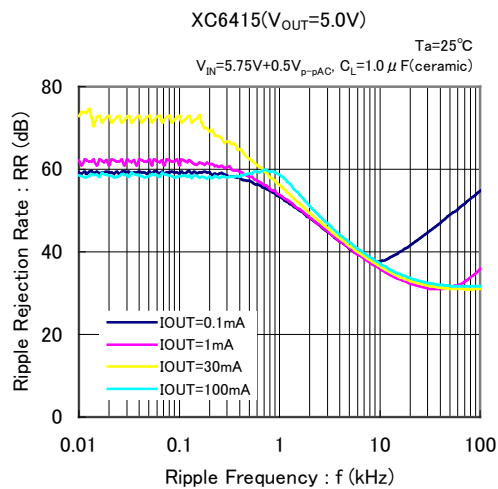
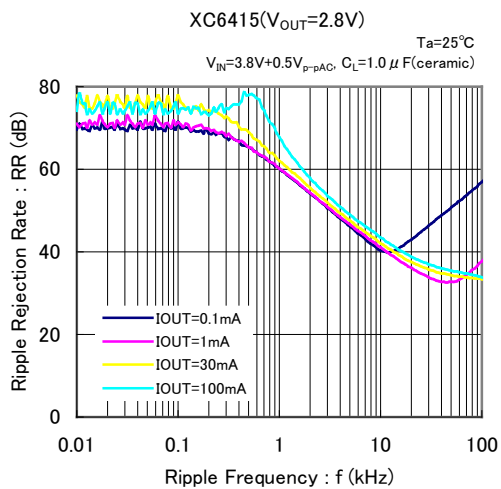

(13) Cross Talk

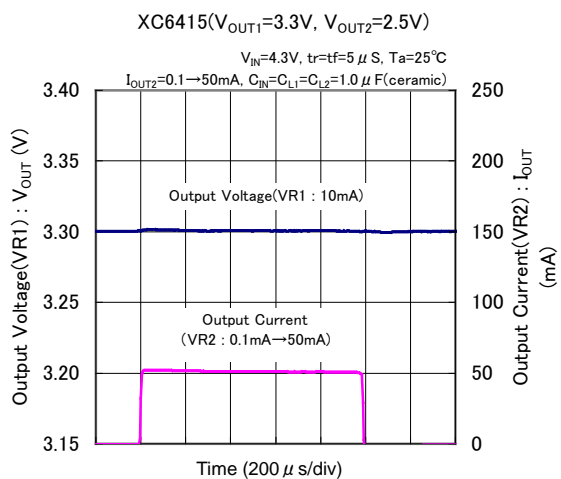

■ PACKAGING INFORMATION

For the latest package information go to, www.torexsemi.com/technical-support/packages

PACKAGE	OUTLINE / LAND PATTERN	THERMAL CHARACTERISTICS	
SOT-26	SOT-26 PKG	Standard Board	SOT-26 Power Dissipation
USP-6C	USP-6C PKG	Standard Board	USP-6C Power Dissipation
		JESD51-7 Board	
USPN-6	USPN-6 PKG	Standard Board	USPN-6 Power Dissipation

MARKING RULE

●SOT-26, USP-6C

SOT-26



USP-6C



USP-6C(Under dot)

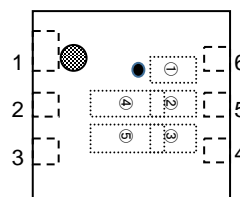

① represents product series

MARK	PRODUCT SERIES
1	XC6415xxxxx
6	

* USP-6C of MARK 6 only Under dot specification.

②③ represents internal sequential number

01~09, 10~99, A0~A9, B0~, B9~, Z9~repeated.
(G, I, J, O, Q, W excluded)

④⑤ represents production lot number

01~09, 10, 11~99, 0A~0Z, 1A~9Z, A0~Z9, AA~ZZ repeated.
(G, I, J, O, Q, W excluded)

*No character inversion used.

●USPN-6

USPN-6



① represents product series

MARK	PRODUCT SERIES
1	XC6415xxxxx
2	
3	

* Mark registered loop.(10xx~1Zxx,20xx~2Zxx,30xx~3Zxx)

② represents internal sequential number

0, 1~9, A, B~Z repeated.
(G, I, J, O, Q, W excluded)

*Once the sequential number of the mark② is used to Z, a mark① symbol will be added.

③ ④ represents production lot number

01~09, 10, 11~99, 0A~0Z, 1A~9Z, A0~Z9, AA~ZZ repeated.
(G, I, J, O, Q, W excluded)

*No character inversion used.