

# XC9220/XC9221 Series

ETR0511-012

16V Input Voltage, Step-Down DC/DC Controller ICs.

## GENERAL DESCRIPTION

The XC9220/XC9221 series is a group of multi-purpose step-down DC/DC controller ICs. The ICs enable a high efficiency, stable power supply with an output current up to 3A to be configured using only a transistor, a coil, a diode, and two capacitors connected externally. Low ESR capacitors such as a ceramic capacitor can be used as an output capacitor.

The XC9220/XC9221 series has a 0.9V ( $\pm 1.5\%$ ) reference voltage, and using externally connected resistors, the output voltage can be set freely. With an internal switching frequency of 300kHz and 500kHz 1.0MHz, small external components can also be used. The XC9220 series is PWM control, and the XC9221 series is PWM/PFM mode, which automatically switches from PWM to PFM during light loads and high efficiencies can be achieved over a wide range of load conditions. As for the soft-start time, the XC9220/XC9221A and C series is internally set to 4msec and the XC9220/XC9221B and D series can be externally set-up. With the built-in UVLO (Under Voltage Lock Out) function, the external P-channel driver transistor is forced OFF when input voltage becomes 2.3V or lower.

## APPLICATIONS

Set top boxes  
Digital TVs  
DVD / HDD recorders  
Smart phones / Mobile phones  
Note PCs / Tablet PCs

## FEATURES

<b>Operating Voltage Range</b>	: 2.8V ~ 16.0V
<b>Output Voltage Externally Set Range</b>	: 1.2V or more ( $V_{FB}=0.9V\pm 1.5\%$ )
<b>Output Current</b>	: Less than 3.0A
<b>Oscillation Frequency</b>	: 300kHz, 500kHz, and 1.0MHz
<b>Control Methods</b>	: PWM control (XC9220) PWM/PFM automatic switching (XC9221)
<b>Soft-Start Function</b>	: 4ms, internally set (XC9220/XC9221A, 500kHz) Externally set (XC9220/XC9221B)
<b>Protection Circuits</b>	: Integral protection (1.0 ms) (XC9220/XC9221 Aand B series) Short-circuit protection
<b>Low ESR Capacitor Compatible</b>	: Ceramic capacitor
<b>Operating Ambient Temperature</b>	: - 40 ~ + 85
<b>Packages</b>	: SOT-25 USP-6C
<b>Environmentally Friendly</b>	: EU RoHS Compliant, Pb Free

## TYPICAL APPLICATION CIRCUIT

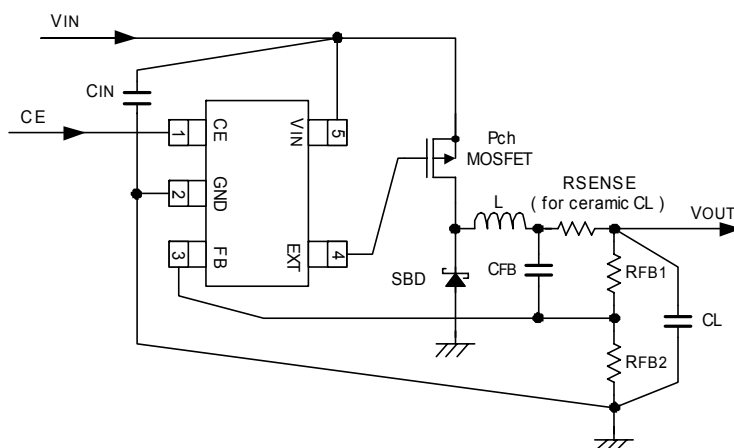

\* RSENSE : Tantalum and electrolytic capacitors can be used, in which case, RSENSE becomes unnecessary.

## TYPICAL PERFORMANCE CHARACTERISTICS

Efficiency vs. Output Current

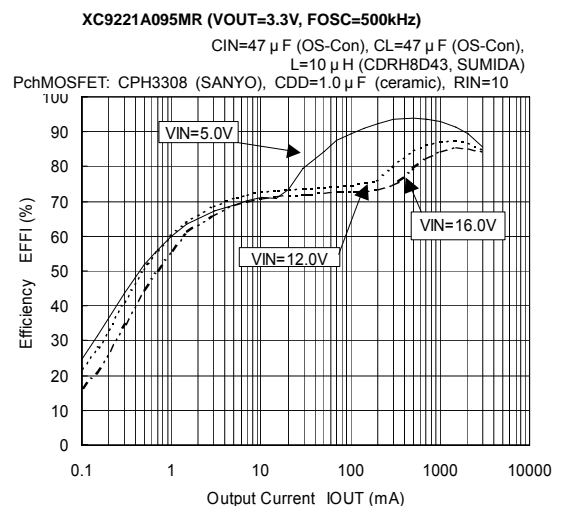

## PIN CONFIGURATION

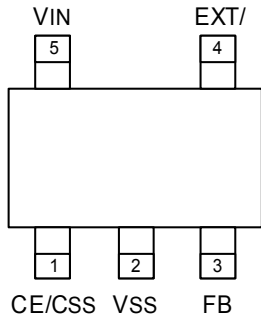

SOT-25  
(TOP VIEW)

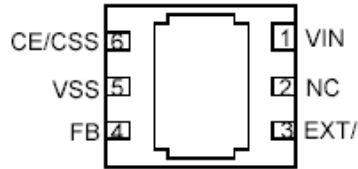

USP-6C  
(BOTTOM VIEW)

\* The dissipation pad for the USP-6C package (preliminary) should be solder-plated in recommended mount pattern and metal masking so as to enhance mounting strength and heat release. If the pad needs to be connected to other pins, it should be connected to the Vss (No.5) pin.

## PIN ASSIGNMENT

PIN NUMBER		PIN NAME	FUNCTION
SOT-25	USP-6C		
1	6	CE/Css	Chip Enable / Soft-Start
2	5	Vss	Ground
3	4	FB	Output Voltage Sense
4	3	EXT/	External Transistor Drive
-	2	NC	No Connection
5	1	VIN	Power Supply

## PRODUCT CLASSIFICATION

### Ordering Information

XC9220 - <sup>(\*)</sup>: PWM control  
 XC9221 - <sup>(\*)</sup>: PWM/PFM automatic switching control

DESIGNATOR	ITEM	SYMBOL	DESCRIPTION
	Type of DC/DC Controller ICs	A	Soft-start internally set with integral protection function
		B	Soft-start externally set with integral protection function
		C	Soft-start internally set without integral protection function
		D	Soft-start externally set without integral protection function
	Output Voltage	09	FB Voltage (Fixed)
	Oscillation Frequency	3	300kHz
		5	500kHz
		A	1.0MHz
- <sup>(*)</sup>	Packages (Order Unit)	MR	SOT-25 (3,000/Reel)
		MR-G	SOT-25 (3,000/Reel)
		ER	USP-6C (3,000/Reel)
		ER-G	USP-6C (3,000/Reel)

<sup>(\*)</sup> The "-G" suffix denotes Halogen and Antimony free as well as being fully EU RoHS compliant.

## BLOCK DIAGRAMS

XC9220/21A and C series

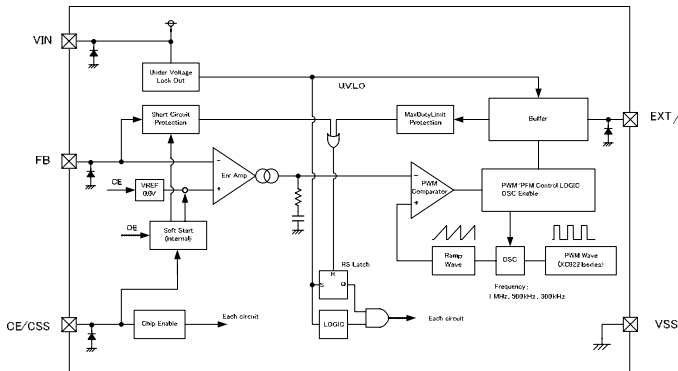

XC9220/21B and D series

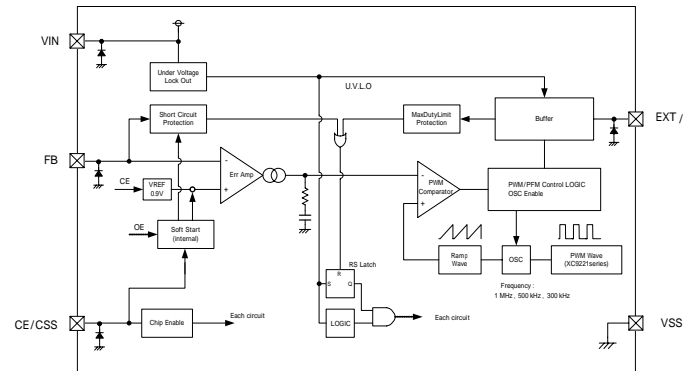

\* Diodes inside the circuits are ESD protection diodes and parasitic diodes.

## FUNCTIONS

### CHIP ENABLE

	IC OPERATION
H	Operation ON
L	Operation OFF

### PRODUCT TYPE

	A	B	C	D
Soft-start externally set	No	Yes	No	Yes
Integral protection function	Yes	Yes	No	No

## ABSOLUTE MAXIMUM RATINGS

Ta = 25°C

PARAMETER	SYMBOL	RATINGS	UNITS
VIN Pin Voltage	VIN	-0.3 ~ +18.0	V
FB Pin Voltage	VFB	-0.3 ~ +18.0	V
CE/Css Pin Voltage	CE	-0.3 ~ +18.0	V
EXT/ Pin Voltage	VEXT	- 0.3 ~ VIN + 0.3	V
EXT/ Pin Current	IEXT	± 100	mA
Power Dissipation	SOT-25	Pd	mW
	USP-6C		
Operating Ambient Temperature	Topr	- 40 ~ + 85	°C
Storage Temperature	Tstg	- 55 ~ +125	°C

## ELECTRICAL CHARACTERISTICS

XC9220/XC9221 A and C series

Ta = 25°C

PARAMETER	SYMBOL	CONDITIONS	MIN.	TYP.	MAX.	UNIT.	CIRCUIT
FB Voltage	V <sub>FB</sub>		0.8865	0.9000	0.9135	V	2
Input Voltage Range	V <sub>IN</sub>		2.8	-	16.0	V	-
UVLO Voltage (Minimum Operating Voltage)	V <sub>UVLO</sub>		1.9	2.3	2.7	V	3
Supply Current 2	I <sub>DD2</sub>	V <sub>IN</sub> =5.0V, FB=1.0V	**			μA	1
Stand-by Current	I <sub>STB</sub>		-	0.1	1.0	μA	1
Oscillation Frequency	f <sub>OSC</sub>	Connected to external components	**			kHz	3
Maximum Duty Ratio	MAXDTY		100	-	-	%	2
PFM Duty Ratio	PFMDTY	No load (XC9221 series only)	15	25	35	%	3
EXT/ High On Resistance	REXTBH		6	10	16	Ω	4
EXT/ Low On Resistance	REXTBL		6	12	20	Ω	4
Integral Protection Time (*2)	t <sub>PRO</sub>	(XC9220/9221 A series)	**			ms	2
Short-Circuit Protection	V <sub>SHORT</sub>		-	-	0.7	V	2
Soft-Start Time	t <sub>SS</sub>		**			ms	2
Efficiency (*1)	EFFI		-	92	-	%	3
FB Voltage	ΔV <sub>FB</sub>		-	±100	-	ppm	2
Temperature Characteristics	ΔT <sub>opr.</sub> V <sub>FB</sub>					/°C	
CE "High" Level Voltage	V <sub>CEH</sub>		1.2	-	-	V	2
CE "Low" Level Voltage	V <sub>CEL</sub>		-	-	0.3	V	3
CE "High" Level Current	I <sub>CEH</sub>	V <sub>IN</sub> =CE=16V	- 0.1	-	0.1	μA	1
CE "Low" Level Current	I <sub>CEL</sub>	V <sub>IN</sub> =16V, CE=0V	- 0.1	-	0.1	μA	1
FB "High" Level Current	I <sub>FBH</sub>	V <sub>IN</sub> =FB=16V	- 0.1	-	0.1	μA	4
FB "Low" Level Current	I <sub>FBL</sub>	V <sub>IN</sub> =16V, FB=0V	- 0.1	-	0.1	μA	4

Unless otherwise stated, V<sub>IN</sub>=5.0V

NOTE:

\*1: EFFI = { (output voltage) x (output current) } / { (input voltage) x (input current) } x 100

\*2: No Integral protection function is available with the XC9220/9221 C series.

\*\* Refer to the CHARACTERISTICS CHART BY OSCILLATION FREQUENCY.

## ELECTRICAL CHARACTERISTICS (Continued)

XC9220/XC9221 B and D series

Ta = 25°C

PARAMETER	SYMBOL	CONDITIONS	MIN.	TYP.	MAX.	UNIT.	CIRCUIT
FB Voltage	V <sub>FB</sub>		0.8865	0.9000	0.9135	V	2
Input Voltage Range	V <sub>IN</sub>		2.8	-	16.0	V	-
UVLO Voltage (Minimum Operating Voltage)	V <sub>UVLO</sub>		1.9	2.3	2.7	V	3
Supply Current 2	I <sub>DD2</sub>	V <sub>IN</sub> =5.0V, FB=1.0V	**			μA	1
Stand-by Current	I <sub>STB</sub>		-	0.1	1.0	μA	1
Oscillation Frequency	f <sub>OSC</sub>	Connected to external components	**			kHz	3
Maximum Duty Ratio	MAXDTY		100	-	-	%	2
PFM Duty Ratio	PFMDTY	No load (XC9221 series only)	15	25	35	%	3
EXT/ High On Resistance	REXTBH		6	10	16	Ω	4
EXT/ Low On Resistance	REXTBL		6	12	20	Ω	4
Integral Protection Time (*4)	t <sub>PRO</sub>	(XC9220/9221 B series)	**			ms	2
Short-Circuit Protection	V <sub>SHORT</sub>		-	-	0.7	V	2
Soft-Start Time	t <sub>SS</sub>	Connected to R <sub>SS</sub> and C <sub>SS</sub>	5.0	10.0	20.0	ms	5
Internal Soft-Start Time (*1)	t <sub>SS_IN</sub>	CE=V <sub>IN</sub>	**			ms	2
Efficiency (*2)	EFFI		-	92	-	%	3
FB Voltage	ΔV <sub>FB</sub>		-	±100	-	ppm	2
Temperature Characteristics	ΔTopr.V <sub>FB</sub>						
CE "High" Level Voltage (*3)	V <sub>CEH</sub>		2.6	-	-	V	2
CE "Low" Level Voltage	V <sub>CEL</sub>		-	-	0.3	V	2
CE "High" Level Current	I <sub>CEH</sub>	V <sub>IN</sub> =CE=16V	- 0.1	-	0.1	μA	1
CE "Low" Level Current	I <sub>CEL</sub>	V <sub>IN</sub> =16V, CE=0V	- 0.1	-	0.1	μA	1
FB "High" Level Current	I <sub>FBH</sub>	V <sub>IN</sub> =FB=16V	- 0.1	-	0.1	μA	4
FB "Low" Level Current	I <sub>FBL</sub>	V <sub>IN</sub> =16V, FB=0V	- 0.1	-	0.1	μA	4

Unless otherwise stated, V<sub>IN</sub>=5.0V

External components: C<sub>SS</sub>=0.1 μF, R<sub>SS</sub>=200kΩ

NOTE:

\*1: Internal soft-start time: In case where the U.V.L.O. function operates temporarily due to the power cutoff etc. when an external C<sub>SS</sub> is charged (V<sub>CE</sub>≥2.6V), the IC restarts operation by the internal soft-start time. Minimum value of soft-start time set externally is equal to the internal soft-start time.

\*2: EFFI={ (output voltage) x (output current) } / { (input voltage) x (input current) } x 100

\*3: The integral latch and short-circuit protection do not function when the CE/CSS pin voltage become lower than 2.6V while the soft-start time.

\*4: No Integral protection function is available with the XC9220/XC9221 D series.

\*\* Refer to the CHARACTERISTICS CHART BY OSCILLATION FREQUENCY.

## CHARACTERISTICS CHART BY OSCILLATION FREQUENCY

PARAMETER	SYMBOL	300kHz			500kHz			1.0MHz		
		MIN.	TYP.	MAX.	MIN.	TYP.	MAX.	MIN.	TYP.	MAX.
Supply Current 2	I <sub>DD2</sub>	-	25	50	-	25	50	-	40	80
Oscillation Frequency	f <sub>OSC</sub>	255	300	345	425	500	575	850	1000	1150
Integral Protection Time	t <sub>PRO</sub>	0.5	1.0	2.0	0.5	1.0	2.0	0.25	0.50	1.00
Soft-Start Time	t <sub>SS</sub>	2	4	8	2	4	8	1	2	4

## TYPICAL APPLICATION CIRCUITS

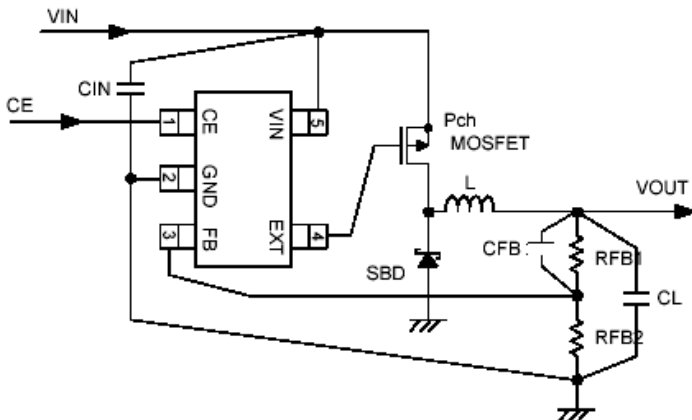

- External Components
  - Pch MOSFET: 2SJ646 (SANYO)
  - SBD: DE5PC3 (SHINDENGEN)
  - L: CDRH8D28-4R7 (4.7  $\mu$  H, SUMIDA / fosc=1.0MHz)
  - CDRH8D43-100 (10  $\mu$  H, SUMIDA / fosc=500kHz)
  - CDRH127-220 (22  $\mu$  H, SUMIDA / fosc=300kHz)
  - CIN: 47  $\mu$  F (OS-CON, SANYO)
  - CL: 47  $\mu$  F (OS-CON, SANYO)

## OPERATIONAL EXPLANATION

The XC9220/XC9221 series consists of a reference voltage source, ramp wave circuit, error amplifier, PWM comparator, phase compensation circuit, protection circuits, UVLO circuit and others. The series ICs compare, using the error amplifier, the voltage of the internal voltage reference source with the feedback voltage from the VOUT pin through split resistors. Phase compensation is performed on the resulting error amplifier output, to input a signal to the PWM comparator to determine the turn-on time during PWM operation. The PWM comparator compares, in terms of voltage level, the signal from the error amplifier with the ramp wave from the ramp wave circuit, and delivers the resulting output to the buffer driver circuit to cause the EXT pin to output a switching duty cycle. This process is continuously performed to ensure stable output voltage.

### <Reference Voltage Source>

The reference voltage source provides the reference voltage to ensure stable output voltage of the DC/DC converter.

### <Oscillator>

The oscillator determines switching frequency. The frequency is fixed internally and can be selected from 300kHz, 500kHz and 1.0MHz. Clock pulses generated in this circuit are used to produce ramp waveforms needed for PWM operation, and to synchronize all the internal circuits.

### <Error Amplifier>

The error amplifier is designed to monitor output voltage. The amplifier compares the reference voltage with the feedback voltage (FB pin voltage) divided by the internal split resistors. When a voltage lower than the reference voltage is fed back, the output voltage of the error amplifier increases. The gain and frequency characteristics of the error amplifier output are fixed internally to deliver an optimized signal to the PWM comparator.

### <Control Methods>

The XC9220 series is PWM control, and the XC9221 series is PWM/PFM automatic switching mode. In the XC9220 series, it is controlled at a constant frequency from light load to heavy load. When a noise etc. is concerned, it is easy to set up a filter etc. since the frequency is fixed. On the other hand, the efficiency at the time of light load may fall. In the XC9221 series, the high efficiency can be drawn from PFM control at the time of light load. In PWM/PFM automatic switching mode, a control method is automatically changed from PWM control to PFM control at the time of light load. If coil current becomes discontinuous at the time of light load, ON time duty intends to reduce less than 25%. Therefore, the PFM circuit operates to output the pulse, which ON time duty fixed to 25% from the EXT/pin. The ON time duty is fixed when PFM operation. The pulse is outputted with the cycle suitable for the conditions at that time. In order that the number of times of switching per unit time may decrease, the efficiency, which it is at the light load time is improved. However, output cycle of the pulse cannot be fixed. For this, the circuit should be designed with this point in mind when using a noise filter etc. The conditions shifting to the PFM operation is depend on values of input voltage, load current, coil and so on.

## OPERATIONAL EXPLANATION (Continued)

### <UVLO (Under Voltage Lock Out) >

When the input voltage becomes 2.3V (TYP.) or lower, the external P-channel driver transistor is forced OFF. Once the UVLO operates, the XC9220/XC9221A and C series (soft-start internally set type) resets the internal circuit. For this, by releasing the UVLO function, the IC performs the soft-start function to initiate output startup operation. When the input voltage falls because of a power cutoff etc. and the IC stops operation due to the UVLO function, the IC resumes its operation by internal soft-start circuit of the XC9220/XC9221B and D series. If the soft-start time is needed to set externally, the CE/Css pin voltage should be reset to 0V. (Please see the soft-start circuit example.)

### UVLO Operation

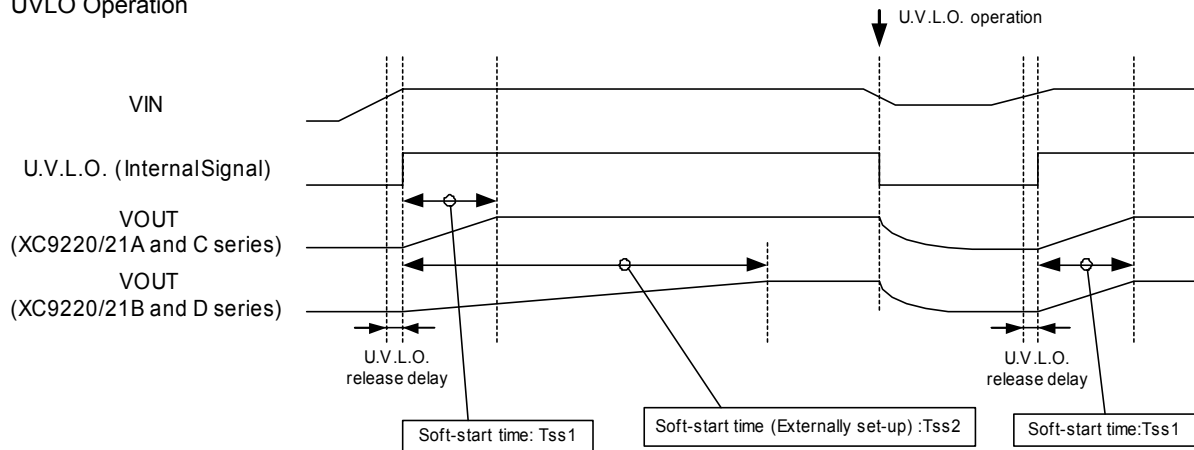

### <Soft-Start Time>

The XC9220/XC9221B and D series can adjust the soft-start time externally via the CE pin. The soft-start function operates until the CE pin voltage becomes 2.6V. Please refer to the following equation for calculating the soft-start time. Minimum soft-start time is equal to the time set internally.

$$TSS = -C_{SS} \times R_{SS} \times \ln \left\{ \frac{V_{CE} - 2.2}{V_{CE}} \right\}$$

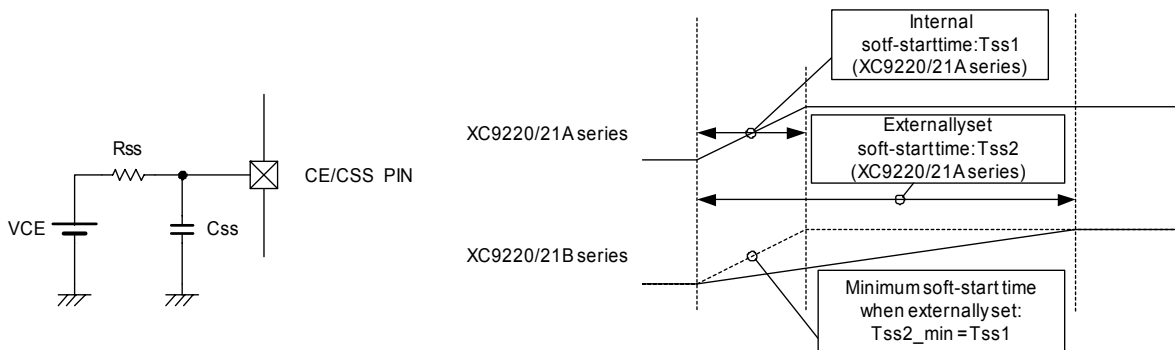

> Circuit Example1 : N-ch Open Drain > Circuit Example2 : CMOS logic (low current dissipation) > Circuit Example3 : CMOS logic (low current dissipation, quick off)

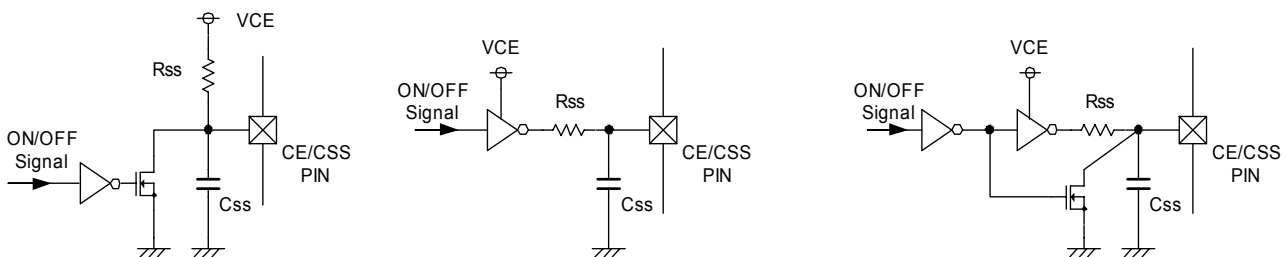

## OPERATIONAL EXPLANATION (Continued)

### <Protection Circuits>

#### 1. Integral Protection Circuit (Latch Type)

In the circuit of the XC9220/XC9221 A and B series, the more load current becomes larger, the duty of the EXT/ pin gradually expands, and the duty reaches maximum (EXT/L). When the MAXDUTY state continues a certain amount of time ( $T_{PRO}$ ), the EXT/ pin holds high level (latching) and keeps the P-ch output driver transistor in OFF state. For resuming the operation from the latching state, please turn off the IC via the CE pin or apply the input voltage again (operates UVLO function and release). The latching state does not mean a complete shutdown, but a state in which pulse output is suspended; therefore, the internal circuitry remains in operation.

However, the integral protection circuit uses the MAXDUTY as a trigger for its operation, it suspends the pulse output no matter what dropout voltage decreases. For the specification including small dropout voltage, the XC9220/XC9221 C or D series, which do not have the integral protection function, are recommended.

#### ● Integral protection circuit

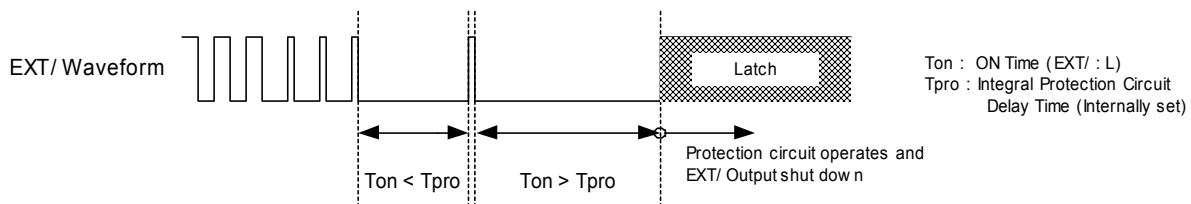

#### 2. Short-Circuit Protection Circuit (Latching Type)

When the FB pin is shorted to the Ground or the output voltage drops rapidly because of over load state etc., the P-ch driver transistor is kept OFF as in the case with the integral protection circuit. (The protection circuit operates when the FB voltage becomes 0.7V or lower.) For releasing the latching state, the circuit is needed to restart via the VIN or the CE pin.

#### ● Short-circuit protection circuit

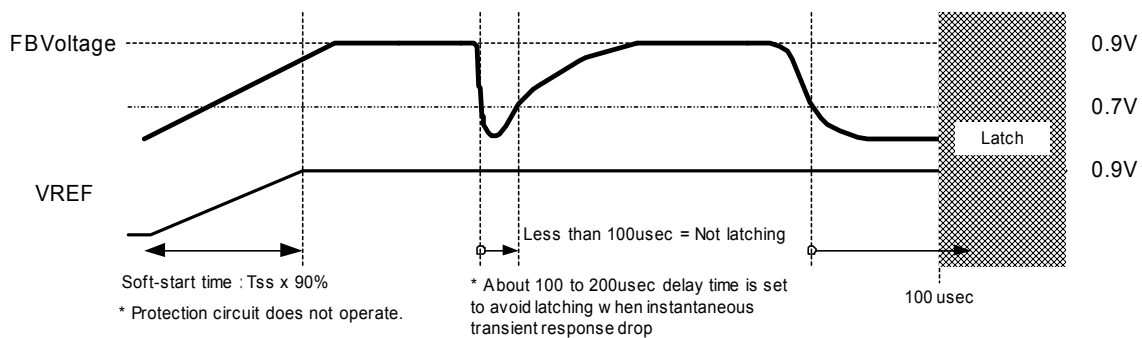



## OPERATIONAL EXPLANATION (Continued)

### Output Voltage Setting

Output voltage can be set by adding split resistors. Output voltage is determined by the following equation, based on the values of RFB1 and RFB2. The sum of RFB1 and RFB2 should normally be 1M or less.

$$V_{OUT} = 0.9 \times (R_{FB1} + R_{FB2}) / R_{FB2}$$

The value of CFB, speed-up capacitor for phase compensation, should be adjusted by the following equation. Fzfb should usually be 5kHz. Adjustments are required from 1kHz to 20kHz depending on the application, value of inductance (L), and value of load capacity (CL).

$$C_{FB} = 1 / (2 \times \pi \times R_{FB1} \times f_{zfb})$$

[Sample calculation: Setting 3.3V VOUT]

$$R_{FB1} = 200k, R_{FB2} = 75k, V_{OUT} = 0.9 \times (200k + 75k) / 75k = 3.300V$$

$$C_{FB} = 1 / (2 \times \pi \times 200k \times 5k) = 150pF$$

[Typical examples]

V <sub>OUT</sub> (V)	R <sub>FB1</sub> (k )	R <sub>FB2</sub> (k )	C <sub>FB</sub> (pF)	V <sub>OUT</sub> (V)	R <sub>FB1</sub> (k )	R <sub>FB2</sub> (k )	C <sub>FB</sub> (pF)
1.2	100	300	330	3.3	200	75	150
1.5	180	270	180	5.0	150	33	220
1.8	220	220	150	12.0	160	13	180

### Recommended MOSFET and SBD (Examples)

I <sub>OUT</sub>	UP TO 500mA	UP TO 1A	UP TO 2A	UP TO 3A
P-ch MOSFET (*1)	CPH3308 (SANYO)		2SJ616 (SANYO)	2SJ646 (SANYO)
Schottky Barrier Diode (SBD) (*2)	XB01SB04A2BR (TOREX)	D1FH3 (SHINDENGEN) CMS02 (TOSHIBA)		DE5PC3 (SHINDENGEN)

\*1: Recommended to use P-ch MOSFET with Ciss less than 1500pF.

\*2: SBD should be used with high-toned reverse characteristics.

### Ceramic Capacitor

With the XC9220/9221 series, a ceramic capacitor can be used as an output capacitor (CL). RSENSE resistor is required for using the ceramic capacitor. The value of RSENSE resistor is determined depending on the setting output voltage as the chart below.

OUTPUT VOLTAGE	RSENSE (m )
V <sub>OUT</sub> 2.5V	100
V <sub>OUT</sub> >2.5V	50

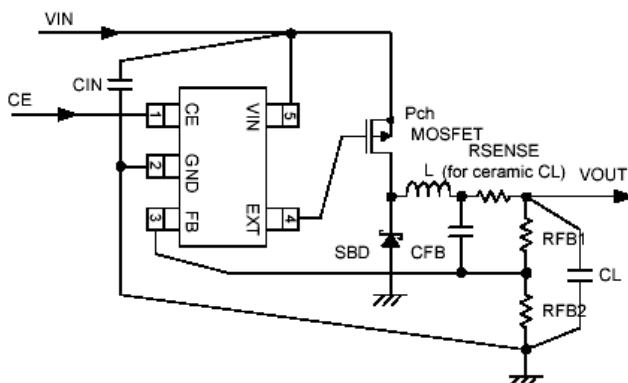

### < External Components >

- P-ch MOSFET: 2SJ646 (SANYO)
- SBD: DE5PC3 (SHINDENGEN)
- L: CDRH8D28-4R7 (4.7 μH, SUMIDA / fosc=1.0MHz)
- CDRH8D43-100 (10 μH, SUMIDA / fosc=500kHz)
- CDRH127-220 (22 μH, SUMIDA / fosc=300kHz)
- CIN: 22 μF (ceramic)
- CL: 22 μF (ceramic / fosc=1.0MHz, 500kHz)
- 47 μF (ceramic / fosc=300kHz)
- RSENSE: 100mΩ (V<sub>OUT</sub> 2.5V)
- 50mΩ (V<sub>OUT</sub> > 2.5V)

## OPERATIONAL EXPLANATION (Continued)

### Setting of Coil Value

Recommended inductance value of coil by oscillation frequency is shown in the chart below.

fosc (kHz)	L (μH)
300	22.0
500	10.0
1000	4.7

However, the more current change in each pulse becomes larger, the more output ripple voltage becomes higher when dropout voltage is high. This may lead to instability. In this case, increasing the coil inductance value will make  $I_{pk\_AC}$  small, and it makes output stable.

$$I_{pk\_AC} = (V_{IN} - V_{OUT}) \times V_{OUT} / (V_{IN} \times L \times f_{osc})$$

L: Coil inductance value

fosc: Oscillation frequency

Please do not exceed the coil rating. Coil peak current is determined by the following equation.

$$I_{pk} = I_{OUT} + I_{pk\_AC} / 2$$

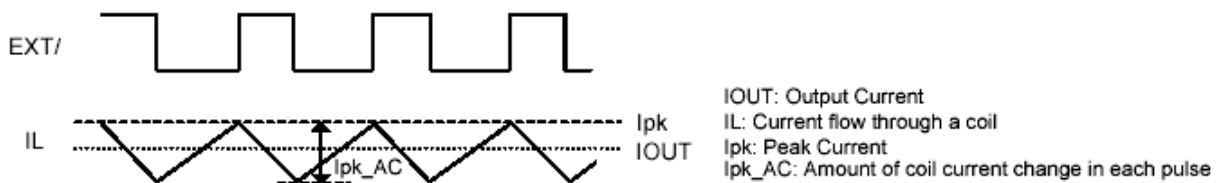

## NOTES ON USE

1. The XC9220/XC9221 series are designed for use with an output ceramic capacitor. If, however, the potential difference between input and output is too large, a ceramic capacitor may fail to absorb the resulting high switching energy and oscillation could occur on the output. If the input-output potential difference is large, connect the output capacitor with large performance to compensate for insufficient capacitance.
2. Spike noise and ripple voltage arise in a switching regulator as with a DC/DC converter. These are greatly influenced by external component selection, such as the coil inductance, capacitance values, and board layout of the external components. Once the design has been completed, verification with actual components should be done.
3. When the difference between input voltage and output voltage is large in PWM control, and the load current is light, very narrow pulses will be outputted, and there is the possibility that some cycles may be skipped completely.
4. When the difference between input voltage and output voltage is small in PWM control, and the load current is heavy, very wide pulses will be outputted and there is the possibility that some cycles may be skipped completely.
5. When using the CE pin by pulling up to the  $V_{IN}$  pin, please be noted to the rising time of the  $V_{IN}$  pin voltage. If the rising time of the  $V_{IN}$  pin voltage is much slower than the soft-start time of the XC9220/XC9221 series, the short-protection circuit starts to operate so that the output may not rise. If you are using the A or the C series, please use a voltage detector or something similar in order to check that the input voltage rises fully. Then, start the series via the CE pin. If you don't want to use an additional detector in this way, we recommend that you use the B or D series, adjusting the soft-start period externally so that the voltage at the  $V_{IN}$  pin rises fully before the soft-start period is completed.

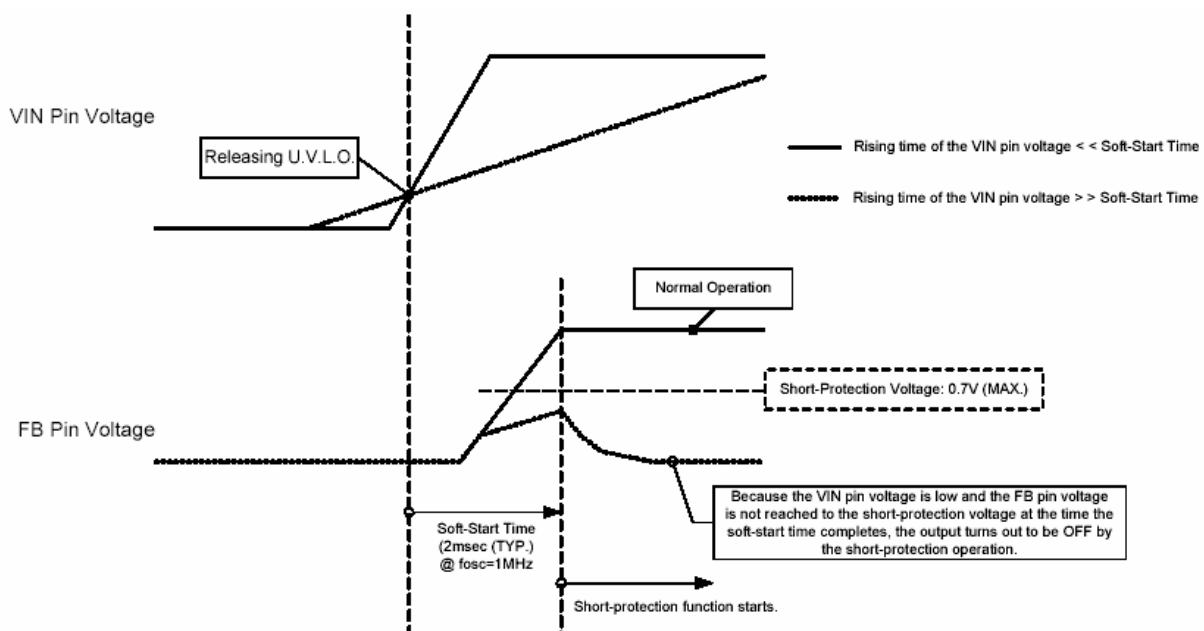

6. Use of the IC at voltages below the recommended minimum operating voltage may lead to instability.
7. This IC and external components should be used within the stated absolute maximum ratings in order to prevent damage to the device.
8. For temporary, transitional voltage drop or voltage rising phenomenon, the IC is liable to malfunction should the ratings be exceeded.
9. Torex places an importance on improving our products and their reliability.  
We request that users incorporate fail-safe designs and post-aging protection treatment when using Torex products in their systems.

## NOTES ON USE (Continued)

### Instructions on Pattern Layout

1. Wire external components as close to the IC as possible and use thick, short connecting traces to reduce the circuit impedance.
2. Please pay special attention to the strengthening of  $V_{IN}$  and  $V_{SS}$  wiring. Switching noise which occurs from the GND may cause the instability of the IC.  
For that matter, it is recommended to connect  $R_{IN}$  (about  $10\ \Omega$ ) and  $C_{DD}$  (about  $1\ \mu F$ ) to the  $V_{IN}$  pin if  $V_{IN}$  voltage is high and noise is high.

[Board layout when XC9220/XC9221 series is mounted with external components]

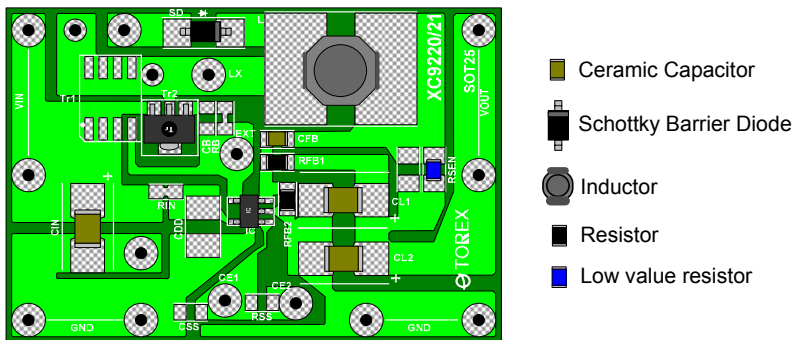

[PC board for the XC9220/XC9221 series]

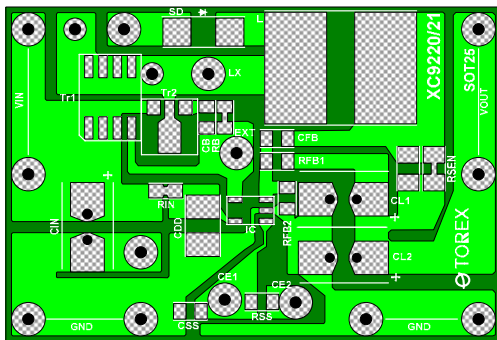

## TEST CIRCUITS

Circuit 1: Supply Current, Stand-by Current, CE Current

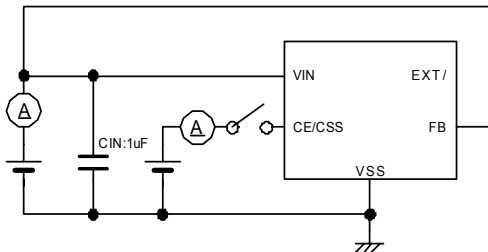

Circuit 2: FB Voltage, Integral Protection, Short-Circuit, Soft-Start, MAXDUTY, CE Voltage

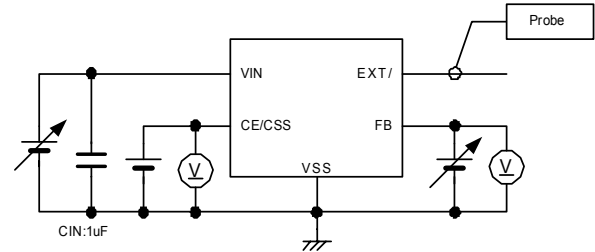

Circuit 3: Oscillation Frequency, PFMDUTY, UVLO, Efficiency

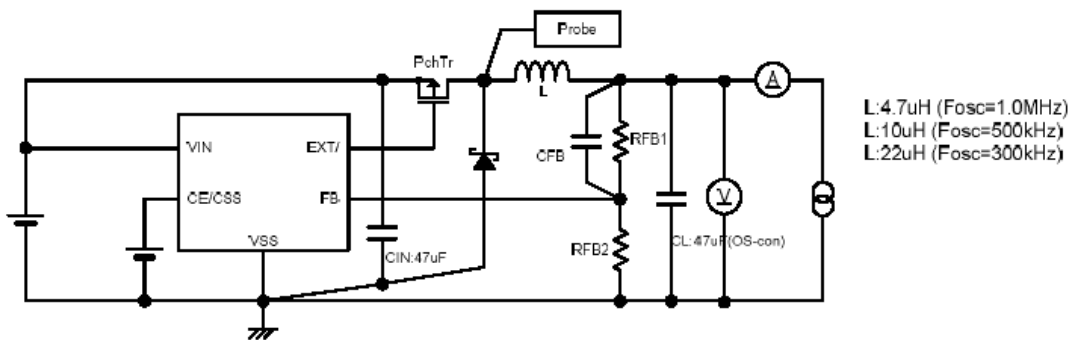

Circuit 4: EXT On Resistance, FB Current

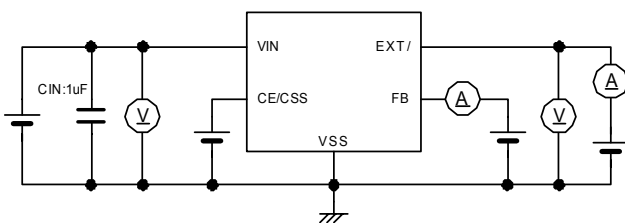

Circuit 5: Soft-Start (Externally set: B and D series)

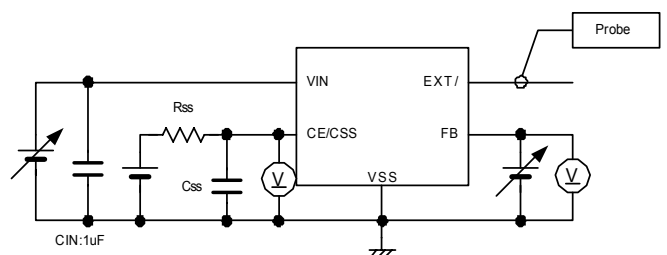

## TYPICAL PERFORMANCE CHARACTERISTICS

### (1) Efficiency vs. Output Current

XC9220/21x095xx

Tr:2SJ646, SBD:DE5PC3, CDRH127-10uH, CIN=10uF(ceramic),  
CL=44uF(ceramic), RSENSE=50mohm  
VIN=12V => VOUT=5V

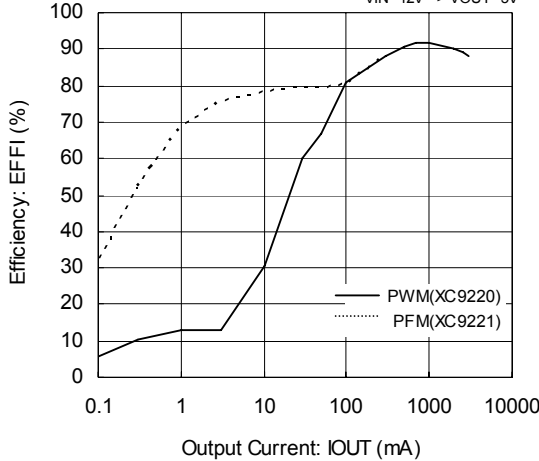

XC9220/21x095xx

Tr:2SJ646, SBD:DE5PC3, CDRH127-10uH  
CIN=10uF(ceramic), CL=44uF(ceramic), RSENSE=50mohm  
VOUT=3.3V

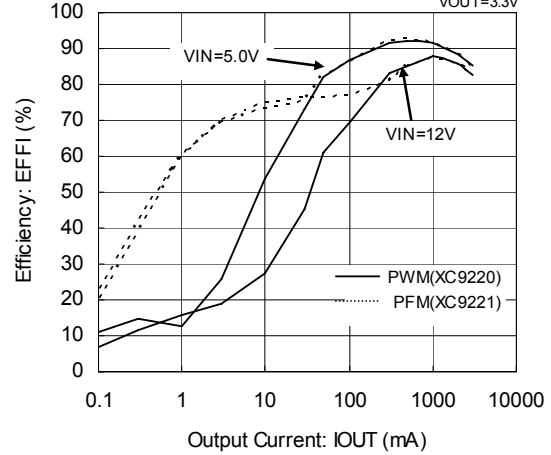

### (2) Output Voltage vs. Output Current

XC9220/21x095xx

Tr:2SJ646, SBD:DE5PC3, CDRH127-10uH  
CIN=10uF(ceramic), CL=44uF(ceramic), RSENSE=50mohm  
VIN=12V => VOUT=5V

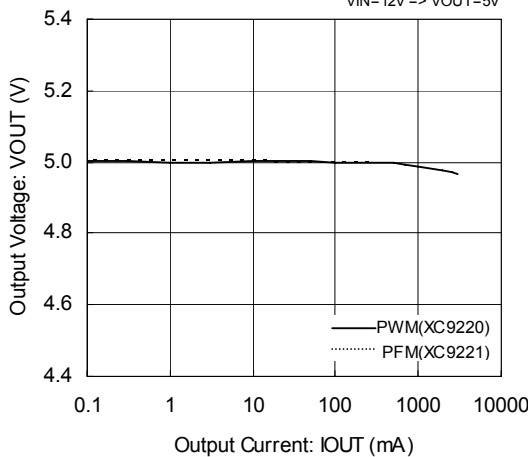

XC9220/21x095xx

Tr:2SJ646, SBD:DE5PC3, CDRH127-10uH  
CIN=10uF(ceramic), CL=44uF(ceramic), RSENSE=50mohm  
VOUT=3.3V

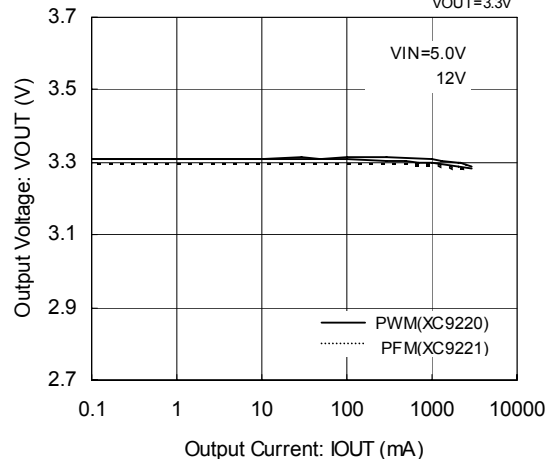

### (3) Output Ripple Voltage vs. Output Current

XC9220/21x095xx

Tr:2SJ646, SBD:DE5PC3, CDRH127-10uH  
CIN=10uF(ceramic), CL=44uF(ceramic), RSENSE=50mohm  
VIN=12V => VOUT=5V

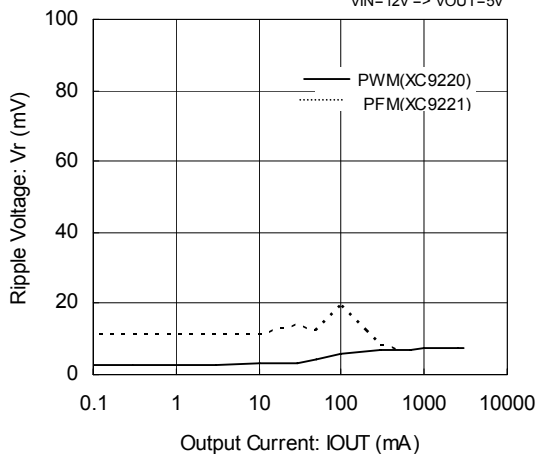

XC9220/21x095xx

Tr:2SJ646, SBD:DE5PC3, CDRH127-10uH  
CIN=10uF(ceramic), CL=44uF(ceramic), RSENSE=50mohm  
VOUT=3.3V

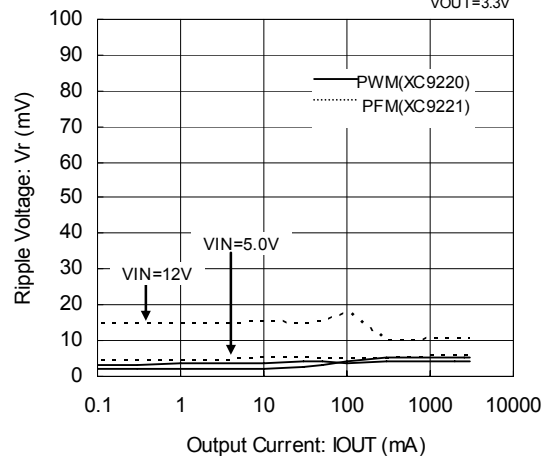

## TYPICAL PERFORMANCE CHARACTERISTICS (Continued)

(4) FB Voltage Temperature Characteristics  
XC9220/21 Series

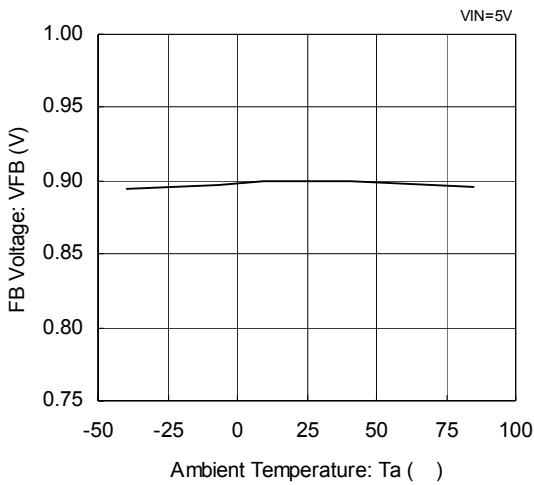

(5) FB Voltage vs. Input Voltage  
XC9220/21 Series

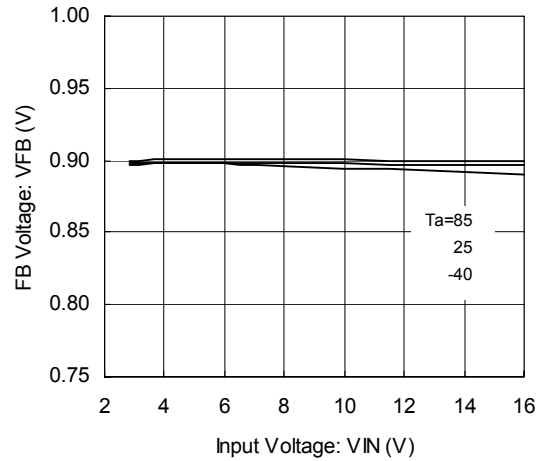

(6) Input Voltage Temperature Characteristics  
XC9220/21 Series

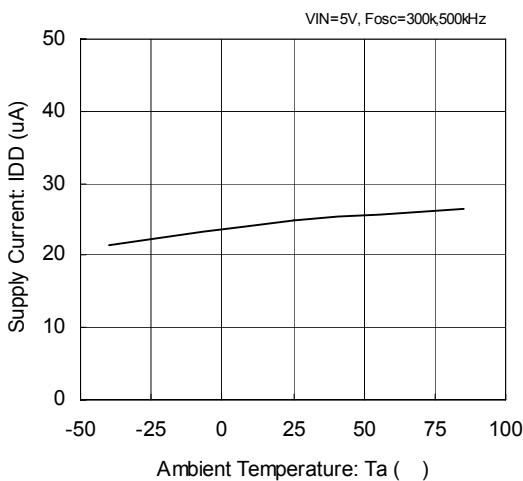

(7) Supply Current vs. Input Voltage  
XC9220/21 Series

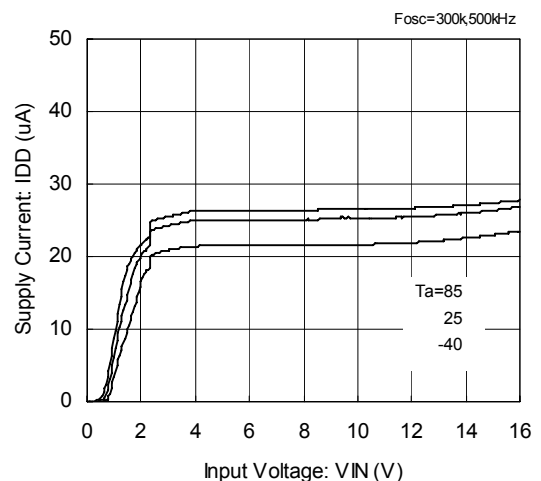

(8) Oscillation Frequency Temperature Characteristics  
XC9220/21x095xx

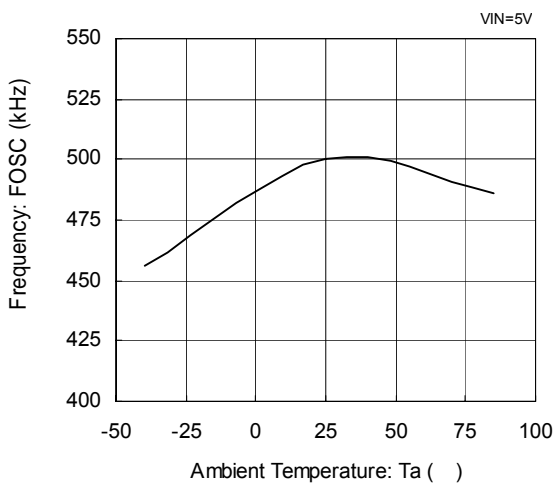

(9) U.V.L.O. Temperature Characteristics  
XC9220/21 Series

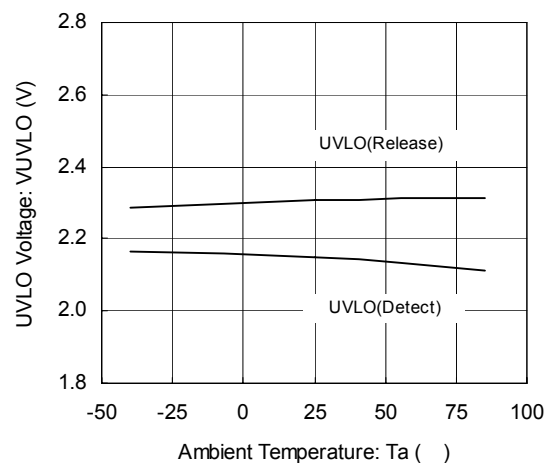

## TYPICAL PERFORMANCE CHARACTERISTICS (Continued)

(10) EXT H ON Resistance Characteristics  
XC9220/21 Series

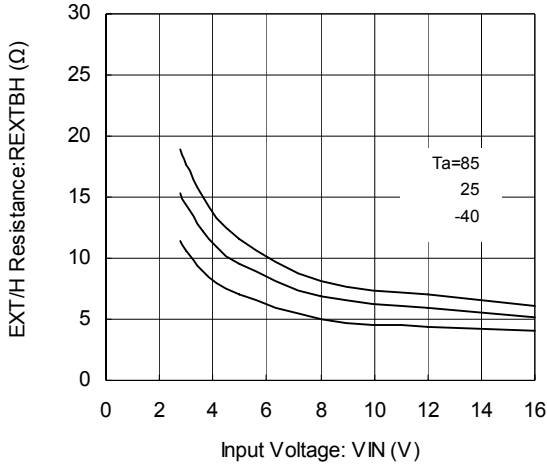

(11) EXT L ON Resistance Characteristics  
XC9220/21 Series

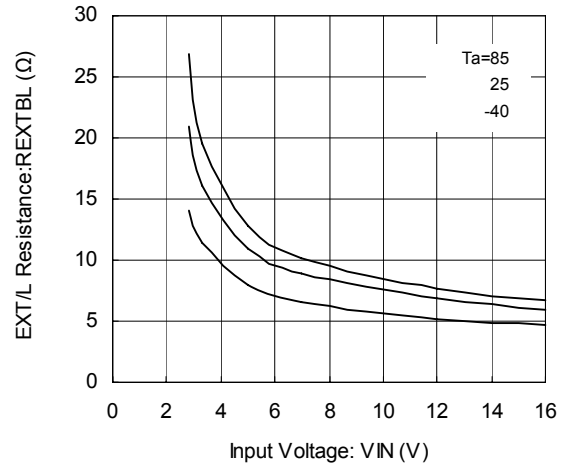

(11) Soft-Start Time Temperature Characteristics  
XC9220/21 Series

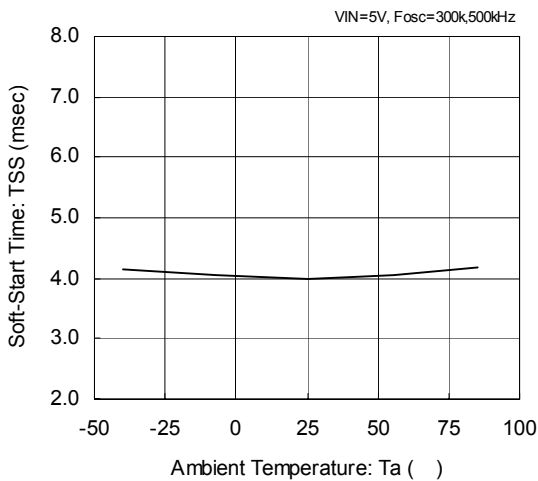

XC9220/21 Series

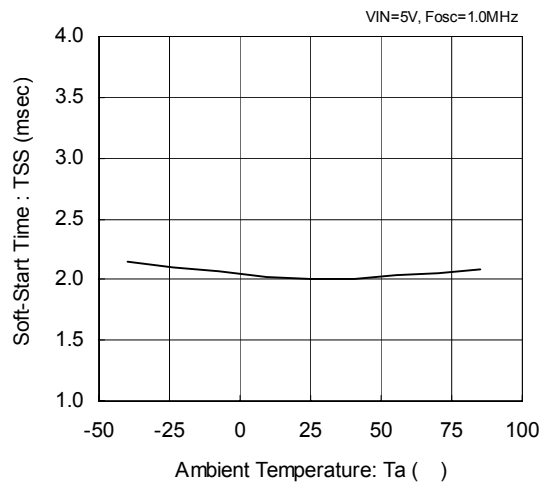

(12) Integral Protection Time Temperature Characteristics

XC9220/21A, B Series

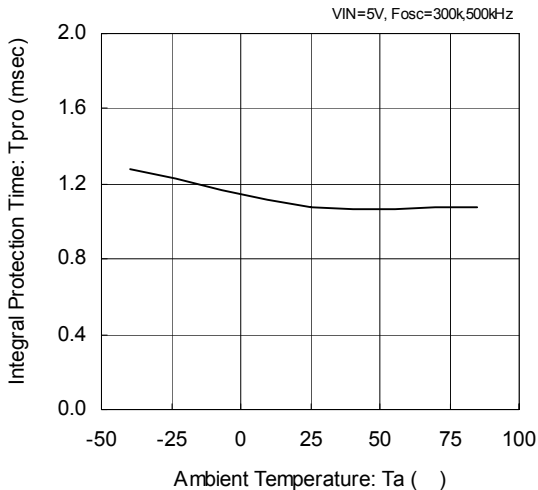

XC9220/21A, B Series

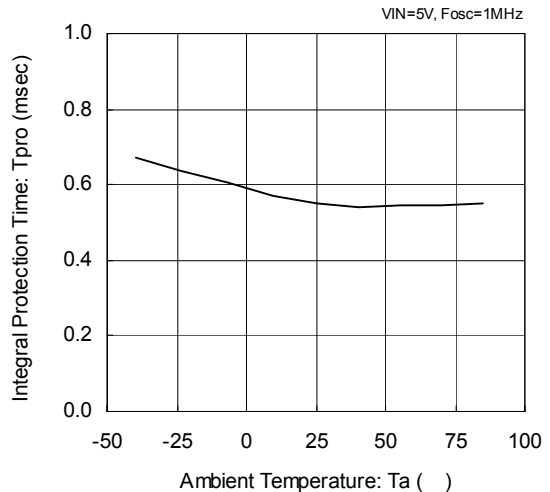



## TYPICAL PERFORMANCE CHARACTERISTICS (Continued)

(13) Short-Circuit Protection Temperature Characteristics

**XC9220/21 Series**

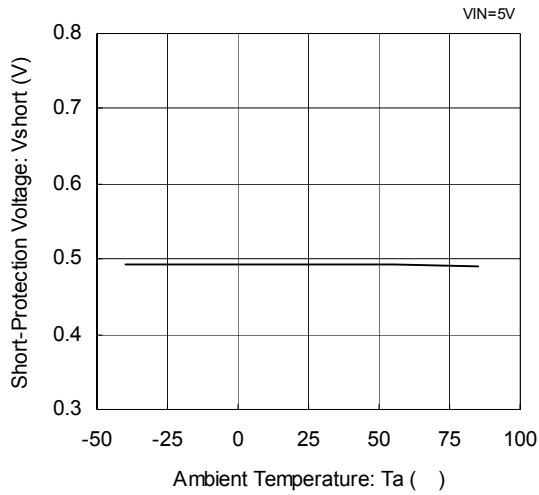

(14) Short-Circuit Protection Voltage vs. Input Voltage

**XC9220/21 Series**

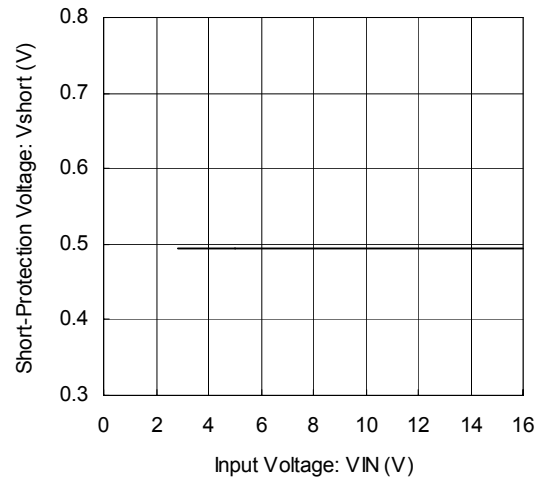

(15) CE Threshold Temperature Characteristics

**XC9220/21 Series**

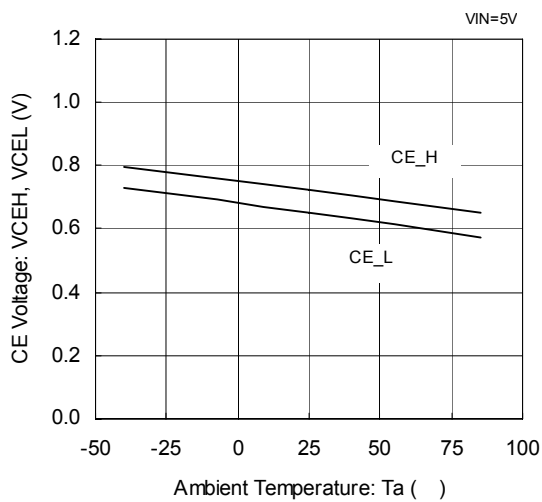

(16) CE Threshold vs. Input Voltage

**XC9220/21 Series**

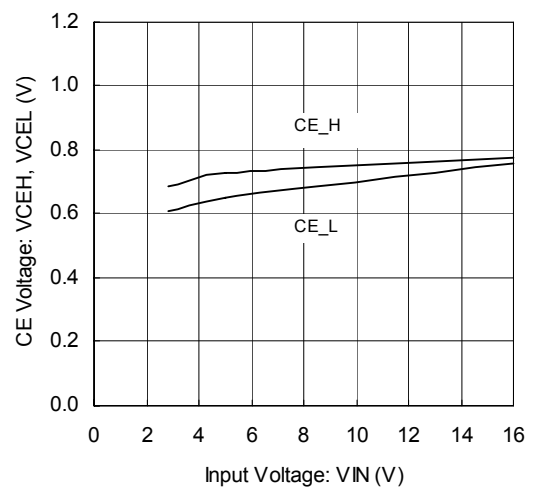

## TYPICAL PERFORMANCE CHARACTERISTICS (Continued)

### (17) Load Transient Response Characteristics

**XC9220x095xx (500kHz, PWM Control)**

<External Components>

Tr: 2SJ616 (SANYO), SBD: D1FH3 (SHINDENGEN), L=10  $\mu$  H CDRH8D43, SUMIDA)

C<sub>IN</sub>=47  $\mu$  F (OS-Con), C<sub>L</sub>=47  $\mu$  F (OS-Con)

I<sub>OUT</sub>=0.1mA 1000mA

V<sub>IN</sub>=5.0V, V<sub>OUT</sub>=3.3V, V<sub>OUT</sub>=100mV/div., Time=50  $\mu$  s/div.

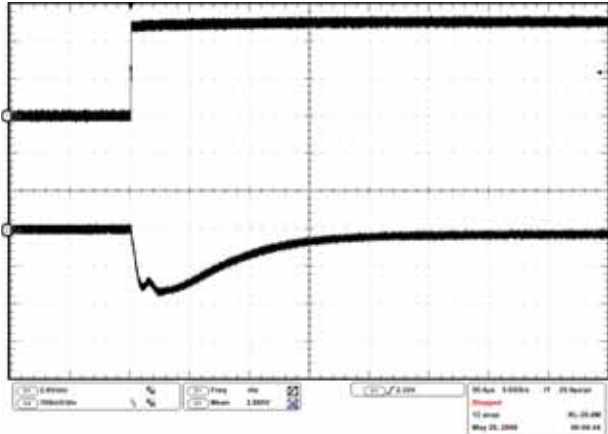

V<sub>IN</sub>=5.0V, V<sub>OUT</sub>=3.3V, V<sub>OUT</sub>=100mV/div., Time=10ms/div.

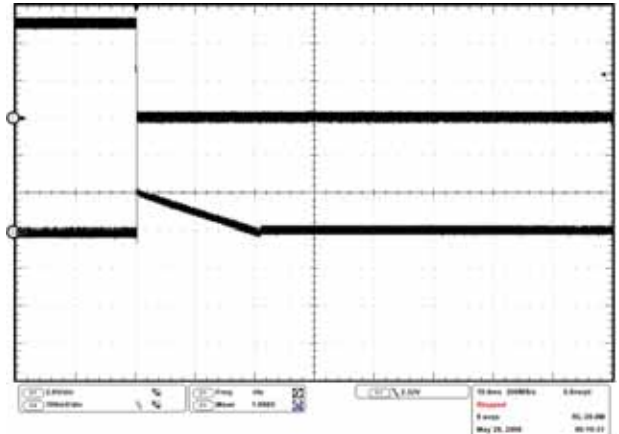

I<sub>OUT</sub>=0.1mA 1000mA

V<sub>IN</sub>=10.0V, V<sub>OUT</sub>=3.3V, V<sub>OUT</sub>=100mV/div., Time=50  $\mu$  s /div.

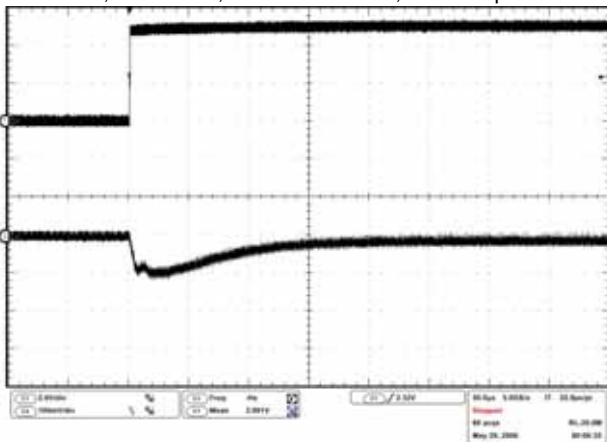

V<sub>IN</sub>=10.0V, V<sub>OUT</sub>=3.3V, V<sub>OUT</sub>=100mV/div., Time=10ms/div.

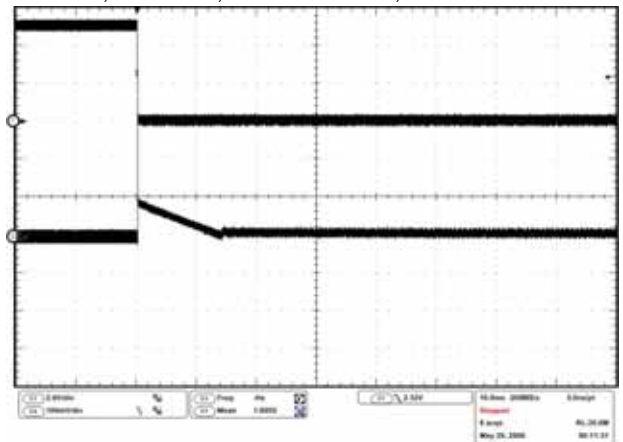

I<sub>OUT</sub>=300mA 3000mA

V<sub>IN</sub>=10.0V, V<sub>OUT</sub>=3.3V, V<sub>OUT</sub>=100mV/div., Time=50  $\mu$  s /div.

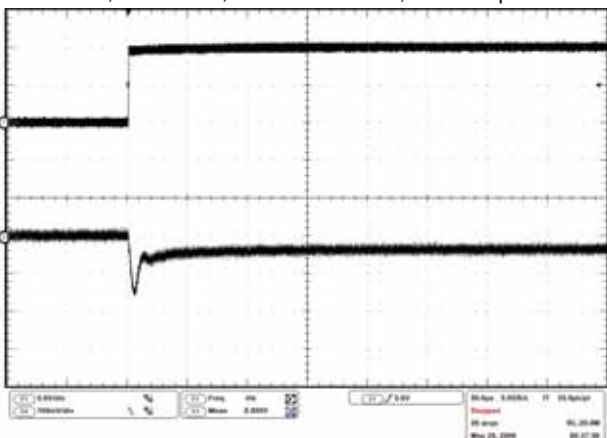

V<sub>IN</sub>=10.0V, V<sub>OUT</sub>=3.3V, V<sub>OUT</sub>=100mV/div., Time=10ms/div.

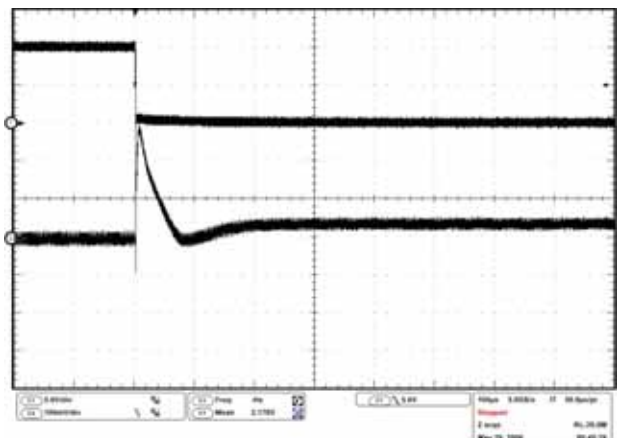

# PACKAGING INFORMATION

SOT-25

Unit : mm

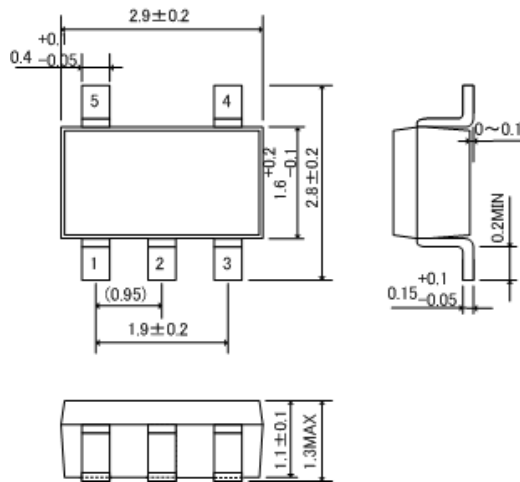

USP-6C

Unit : mm

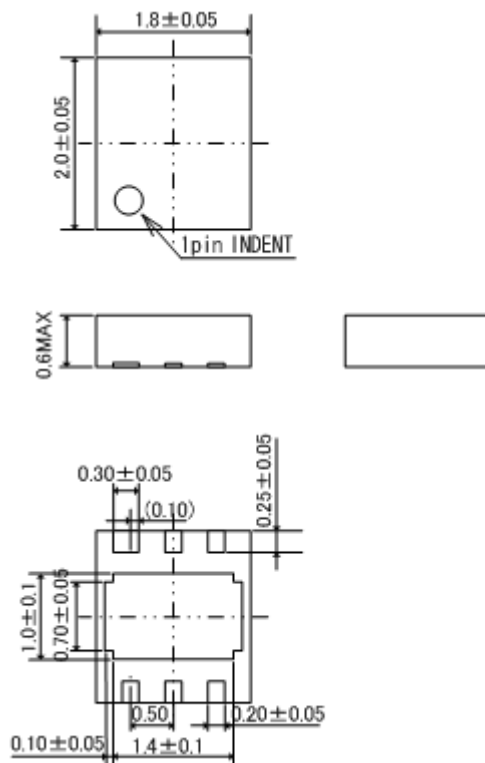

## PACKAGING INFORMATION (Continued)

USP-6C Reference Pattern Layout

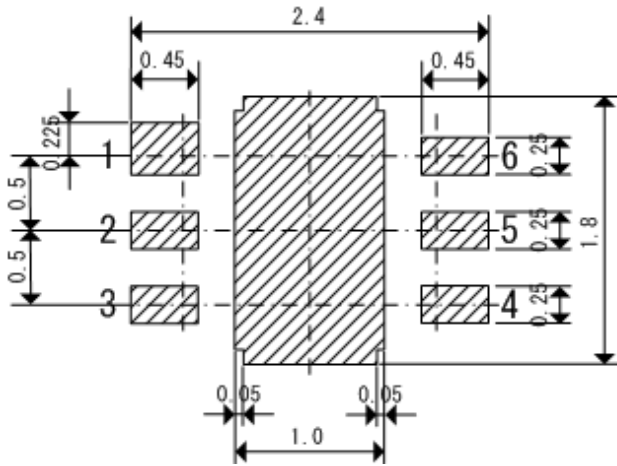

USP-6C Reference Metal Mask Design

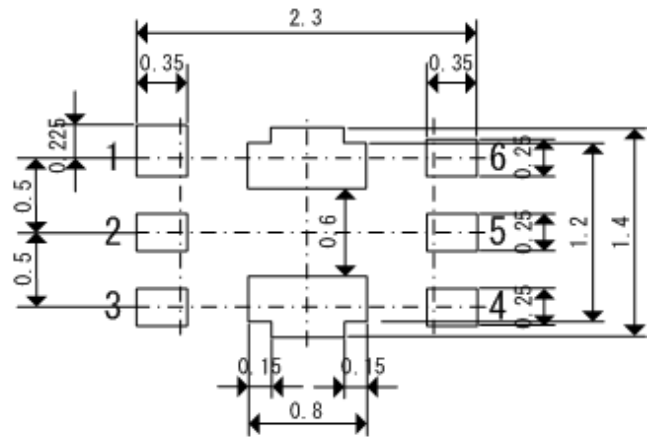

## MARKING RULE

### SOT-25

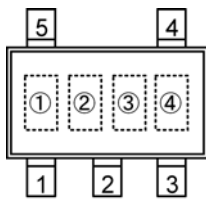

SOT-25 (TOP VIEW)

represents product series

MARK	PRODUCT SERIES
M	XC9220xxxxxx
N	XC9221xxxxxx

represents product types

MARK	FUNCTION	PRODUCT SERIES
A	Soft-start internally set with integral protection function	XC922xAxxxxx
B	Soft-start externally set with integral protection function	XC922xBxxxxx
C	Soft-start internally set without integral protection function	XC922xCxxxxx
D	Soft-start externally set without integral protection function	XC922xDxxxxx

represents oscillation frequency

MARK	OSCILLATION FREQUENCY	PRODUCT SERIES
3	300kHz	XC922xxxx3xx
5	500kHz	XC922xxxx5xx
A	1.0MHz	XC922xxxxAxx

represents production lot number

0 to 9, A to Z and inverted 0 to 9, A to Z repeated.  
(G, I, J, O, Q, W excluded.)

### USP-6C

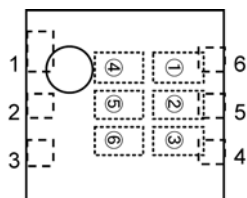

USP-6C (TOP VIEW)

represents product series

MARK	PRODUCT SERIES
1	XC9220xxxxxx
D	XC9221xxxxxx

represent product types

MARK	FUNCTIONS	PRODUCT SERIES
A	Soft-start internally set with integral protection function	XC922xAxxxxx
B	Soft-start externally set with integral protection function	XC922xBxxxxx
C	Soft-start internally set without integral protection function	XC922xCxxxxx
D	Soft-start externally set without integral protection function	XC922xDxxxxx

represents FB voltage

MARK		FB VOLTAGE	PRODUCT SERIES
0	9	0.9V fixed	XC922xx09xxx

represents oscillation frequency

MARK	OSCILLATION FREQUENCY	PRODUCT SERIES
3	300kHz	XC922xxxx3xx
5	500kHz	XC922xxxx5xx
A	1.0MHz	XC922xxxxAxx

represents production lot number

0 to 9, A to Z repeated. (G, I, J, O, Q, W excluded.)

\* No character inversion used.