

Ultra Low Power Synchronous Step-Down PFM DC/DC Converter

☆GreenOperation Compatible

■ GENERAL DESCRIPTION

XC9265 series are Ultra Low Power synchronous-rectification type PFM step down DC/DC converters with a built-in 0.4Ω (TYP.) Pch driver and 0.4Ω (TYP.) Nch synchronous switching transistor, designed to allow the use of ceramic capacitor.

PFM control enables a low quiescent current, making these products ideal for battery operated devices that require high efficiency and long battery life.

Only inductor, C_{IN} and C_L capacitors are needed as external parts to make a step down DC/DC circuit.

Operation voltage range is from 2.0V to 6.0V. This product has fixed output voltage from 1.0V to 4.0V (accuracy: $\pm 2.0\%$) in increments of 0.05V.

During stand-by, all circuits are shutdown to reduce consumption to as low as 0.1μA (TYP.) or less.

With the built-in UVLO (Under Voltage Lock Out) function, the internal P-channel MOS driver transistor is forced OFF when input voltage gets lower than UVLO detection voltage. Besides, XC9265 series has UVLO release voltage of 1.8V (Typ.). The product with C_L discharge function can discharge C_L capacitor during stand-by mode due to the internal resistance by turning on the internal switch between V_{OUT} -GND. This enables output voltage restored to GND level fast.

■ APPLICATIONS

- Wearable Devices
- Smart meters
- Bluetooth units
- Energy Harvest devices
- Backup power supply circuits
- Portable game consoles
- Devices with 1 Lithium cell

■ FEATURES

Input Voltage Range	: 2.0V~6.0V
Output Voltage Setting	: 1.0V~4.0V ($\pm 2.0\%$, 0.05V increments)
Output Current	: 200mA (XC9265A/C) 50mA (XC9265B/D)
Driver Transistor	: 0.4Ω (Pch Driver Tr) 0.4Ω (Nch Synchronous rectifier Switch Tr)
Supply Current	: 0.50μA @ $V_{OUT(T)}=1.8V$ (TYP.)
Control Method	: PFM control
High Speed Transient	: 50mV ($V_{IN}=3.6V$, $V_{OUT}=1.8V$, $I_{OUT}=10\mu A \rightarrow 50mA$)
PFM Switching Current	: 330mA (XC9265A/C), 180mA (XC9265B/D)
Function	: Short Protection C _L Discharge (XC9265C/ D) UVLO Ceramic Capacitor Compatible
Operation Ambient Temperature	: -40 ~ 85°C
Package	: SOT-25, USP-6EL
Environmentally Friendly	: EU RoHS compliant, Pb Free

■ TYPICAL APPLICATION CIRCUIT

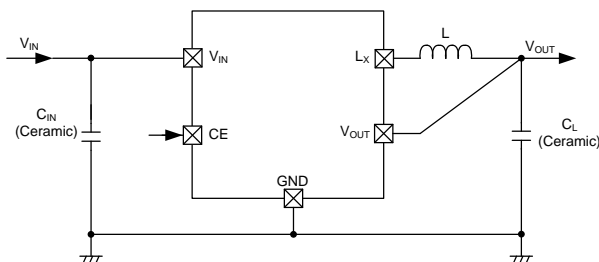

■ TYPICAL PERFORMANCE CHARACTERISTICS

● Efficiency vs. Output Current

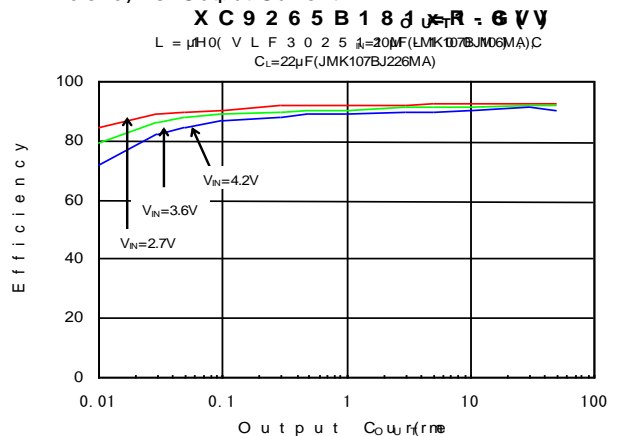

XC9265 Series

■ BLOCK DIAGRAM

XC9265A / XC9265B Type



* Diodes inside the circuit are an ESD protection diode and a parasitic diode.

XC9265C / XC9265D Type

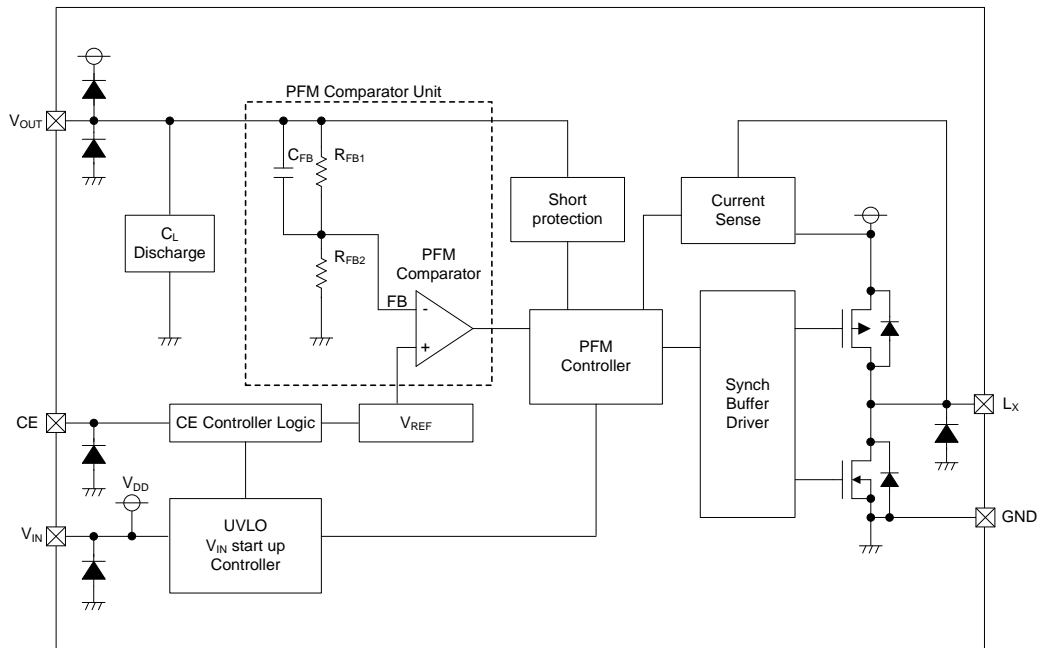

* Diodes inside the circuit are an ESD protection diode and a parasitic diode.

■ PRODUCT CLASSIFICATION

● Ordering information

XC9265①②③④⑤⑥-⑦

DESIGNATOR	ITEM	SYMBOL	DESCRIPTION
①	Product Type	A	I _{OUT} =200mA Without C _L Discharge
		B	I _{OUT} =50mA Without C _L Discharge
		C	I _{OUT} =200mA With C _L Discharge
		D	I _{OUT} =50mA With C _L Discharge
②③	Output Voltage	10 ~ 40	Output Voltage : e.g. V _{OUT} =1.80V⇒②=1, ③=8 Output Voltage Range: 1.0V~4.0V (0.05V increments)
④	Output Voltage Type	1	Output Voltage {x.x0V} (the 2nd decimal place is "0")
		B	Output Voltage {x.x5V} (the 2nd decimal place is "5")
⑤⑥-⑦ ^(*)	Packages (Order Unit)	4R-G	USP-6EL (3,000pcs/Reel)
		MR-G	SOT-25 (3,000pcs/Reel)

(*) The "-G" suffix denotes Halogen and Antimony free as well as being fully EU RoHS compliant.

XC9265 Series

PIN CONFIGURATION

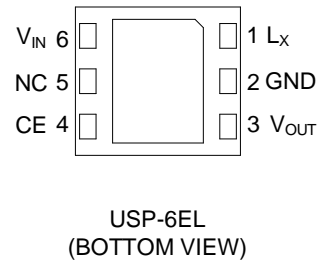

* The dissipation pad for the USP-6EL package should be solder-plated in recommended mount pattern and metal masking so as to enhance mounting strength and heat release. The mount pattern should be connected to GND pin (No.2).

PIN ASSIGNMENT

PIN NUMBER		PIN NAME	FUNCTIONS
USP-6EL	SOT-25		
1	5	L _x	Switching
2	2	GND	Ground
3	4	V _{OUT}	Output Voltage
4	3	CE	Chip Enable
5	-	NC	No Connection
6	1	V _{IN}	Power Input

PIN FUNCTION ASSIGNMENT

PIN NAME	SIGNAL	STATUS
CE	H	Operation (All Series)
	L	Standby (All Series)

* Please do not leave the CE pin open.

ABSOLUTE MAXIMUM RATINGS

Ta=25°C				
PARAMETER	SYMBOL	RATINGS	UNITS	
V _{IN} Pin Voltage	V _N	-0.3 ~ 7.0	V	
L _x Pin Voltage	V _{LX}	-0.3 ~ V _{IN} + 0.3 or 7.0 ⁽¹⁾	V	
V _{OUT} Pin Voltage	V _{OUT}	-0.3 ~ V _{IN} + 0.3 or 7.0 ⁽¹⁾	V	
CE Pin Voltage	V _{CE}	-0.3 ~ 7.0	V	
L _x Pin Current	I _{LX}	1000	mA	
Power Dissipation	SOT-25	Pd	250	mW
			600 (40mm x 40mm Standard board) ⁽²⁾	
			760 (JESD51-7 Board)	
			120	
			750 (40mm x 40mm Standard board) ⁽²⁾	
Operating Ambient Temperature	T _{opr}	-40 ~ 85	°C	
Storage Temperature	T _{stg}	-55 ~ 125	°C	

* All voltages are described based on the GND.

⁽¹⁾ The maximum value is the lower of either V_{IN} + 0.3V or 7.0V.

⁽²⁾ The power dissipation figure shown is PCB mounted and is for reference only. Please refer to PACKAGING INFORMATION for the mounting condition.

ELECTRICAL CHARACTERISTICS

●XC9265Axxx Type, without C_L discharge function

T_a=25°C

PARAMETER	SYMBOL	CONDITIONS	MIN.	TYP.	MAX.	UNITS	CIRCUIT
Input Voltage	V _{IN}	-	2.0	-	6.0	V	①
Output Voltage	V _{OUT(E)} ⁽²⁾	Resistor connected with L _x pin. Voltage which L _x pin changes "L" to "H" level while V _{OUT} is decreasing.	E1			V	②
UVLO Release Voltage	V _{UVLO(E)}	V _{CE} =V _{IN} , V _{OUT} =0V. Resistor connected with L _x pin. Voltage which L _x pin changes "L" to "H" level while V _{IN} is increasing.	1.65	1.8	1.95	V	②
UVLO Hysteresis Voltage	V _{HYS(E)}	V _{CE} =V _{IN} , V _{OUT} =0V. Resistor connected with L _x pin. V _{UVLO(E)} - Voltage which L _x pin changes "H" to "L" level while V _{IN} is decreasing.	0.11	0.15	0.24	V	②
Supply Current	I _q	V _{IN} =V _{CE} =V _{OUT(T)} +0.5V ⁽¹⁾ , V _{IN} =2.0V, if V _{OUT(T)} ≤1.5V ⁽¹⁾ , V _{OUT} =V _{OUT(T)} +0.5V ⁽¹⁾ , L _x =Open.	E2			μA	③
Standby Current	I _{STB}	V _{IN} =5.0V, V _{CE} =V _{OUT} =0V, L _x =Open.	-	0.1	1.0	μA	③
L _x SW "H" Leak Current	I _{LEAKH}	V _{IN} =5.0V, V _{CE} =V _{OUT} =0V, V _{LX} =0V.	-	0.1	1.0	μA	③
L _x SW "L" Leak Current	I _{LEAKL}	V _{IN} =5.0V, V _{CE} =V _{OUT} =0V, V _{LX} =5.0V.	-	0.1	1.0	μA	③
PFM Switching Current	I _{PFM}	V _{IN} =V _{CE} =V _{OUT(T)} +2.0V ⁽¹⁾ , I _{OUT} =10mA.	260	330	400	mA	①
Maximum Duty Ratio ⁽³⁾	MAXDTY	V _{IN} =V _{OUT} =V _{OUT(T)} ×0.95V ⁽¹⁾ , V _{CE} =1.2V Resistor connected with L _x pin.	100	-	-	%	②
Efficiency ⁽⁴⁾	EFFI	V _{IN} =V _{CE} =5.0V, V _{OUT(T)} =4.0V ⁽¹⁾ , I _{OUT} =30mA.	-	93	-	%	①
Efficiency ⁽⁴⁾	EFFI	V _{IN} =V _{CE} =3.6V, V _{OUT(T)} =3.3V ⁽¹⁾ , I _{OUT} =30mA.	-	93	-	%	①
Efficiency ⁽⁴⁾	EFFI	V _{IN} =V _{CE} =3.6V, V _{OUT(T)} =1.8V ⁽¹⁾ , I _{OUT} =30mA.	-	87	-	%	①
L _x SW "Pch" ON Resistance ⁽⁵⁾	R _{LXP}	V _{IN} =V _{CE} =5.0V, V _{OUT} =0V, I _{LX} =100mA.	-	0.4	0.65	Ω	④
L _x SW "Nch" ON Resistance	R _{LXN}	V _{IN} =V _{CE} =5.0V.	-	0.4 ⁽⁶⁾	-	Ω	-
Output Voltage Temperature Characteristics	$\frac{\Delta V_{OUT}}{(V_{OUT} \cdot \Delta T_{opr})}$	-40°C ≤ T _{opr} ≤ 85°C.	-	±100	-	ppm/°C	②
CE "High" Voltage	V _{CEH}	V _{OUT} =0V. Resistor connected with L _x pin. Voltage which L _x pin changes "L" to "H" level while V _{CE} =0.2→1.5V.	1.2	-	6.0	V	⑤
CE "Low" Voltage	V _{CEL}	V _{OUT} =0V. Resistor connected with L _x pin. Voltage which L _x pin changes "H" to "L" level while V _{CE} =1.5→0.2V.	GND	-	0.3	V	⑤
CE "High" Current	I _{CEH}	V _{IN} =V _{CE} =5.0V, V _{OUT} =0V, L _x =Open.	-0.1	-	0.1	μA	⑤
CE "Low" Current	I _{CEL}	V _{IN} =5.0V, V _{CE} =V _{OUT} =0V, L _x =Open.	-0.1	-	0.1	μA	⑤
Short Protection Threshold Voltage	V _{SHORT}	Resistor connected with L _x pin. Voltage which L _x pin changes "H" to "L" level while V _{OUT} =V _{OUT(T)} +0.1V→0V ⁽¹⁾ .	0.4	0.5	0.6	V	②

Unless otherwise stated, V_{IN}=V_{CE}=5.0V

⁽¹⁾ V_{OUT(T)}=Nominal Output Voltage

⁽²⁾ V_{OUT(E)}=Effective Output Voltage

The actual output voltage value V_{OUT(E)} is the PFM comparator threshold voltage in the IC.

Therefore, the DC/DC circuit output voltage, including the peripheral components, is boosted by the ripple voltage average value.

Please refer to the characteristic example.

⁽³⁾ Not applicable to the products with V_{OUT(T)} < 2.15V since it is out of operational voltage range.

⁽⁴⁾ EFFI=[(Output Voltage)×(Output Current)] / [(Input Voltage)×(Input Current)]×100

⁽⁵⁾ L_x SW "Pch" ON resistance = (V_{IN} - V_{LX} pin measurement voltage) / 100mA

⁽⁶⁾ Designed value

ELECTRICAL CHARACTERISTICS (Continued)

●XC9265Bxxx Type, without C_L discharge function

T_a=25°C

PARAMETER	SYMBOL	CONDITIONS	MIN.	TYP.	MAX.	UNITS	CIRCUIT
Input Voltage	V _{IN}	-	2.0	-	6.0	V	①
Output Voltage	V _{OUT(E)} ⁽²⁾	Resistor connected with L _X pin. Voltage which L _X pin changes "L" to "H" level while V _{OUT} is decreasing.	E1			V	②
UVLO Release Voltage	V _{UVLO(E)}	V _{CE} =V _{IN} , V _{OUT} =0V. Resistor connected with L _X pin. Voltage which L _X pin changes "L" to "H" level while V _{IN} is increasing.	1.65	1.8	1.95	V	②
UVLO Hysteresis Voltage	V _{HYS(E)}	V _{CE} =V _{IN} , V _{OUT} =0V. Resistor connected with L _X pin. V _{UVLO(E)} - Voltage which L _X pin changes "H" to "L" level while V _{IN} is decreasing.	0.11	0.15	0.24	V	②
Supply Current	I _q	V _{IN} =V _{CE} =V _{OUT(T)} +0.5V ⁽¹⁾ , V _{IN} =2.0V, if V _{OUT(T)} ≤ 1.5V ⁽¹⁾ , V _{OUT} =V _{OUT(T)} +0.5V ⁽¹⁾ , L _X =Open.	E2			μA	③
Standby Current	I _{STB}	V _{IN} =5.0V, V _{CE} =V _{OUT} =0V, L _X =Open.	-	0.1	1.0	μA	③
L _X SW "H" Leak Current	I _{LEAKH}	V _{IN} =5.0V, V _{CE} =V _{OUT} =0V, V _{LX} =0V.	-	0.1	1.0	μA	③
L _X SW "L" Leak Current	I _{LEAKL}	V _{IN} =5.0V, V _{CE} =V _{OUT} =0V, V _{LX} =5.0V.	-	0.1	1.0	μA	③
PFM Switching Current	I _{PFM}	V _{IN} =V _{CE} =V _{OUT(T)} +2.0V ⁽¹⁾ , I _{OUT} =10mA.	115	180	250	mA	①
Maximum Duty Ratio ⁽³⁾	MAXDTY	V _{IN} =V _{OUT} =V _{OUT(T)} ×0.95V ⁽¹⁾ , V _{CE} =1.2V Resistor connected with L _X pin.	100	-	-	%	②
Efficiency ⁽⁴⁾	EFFI	V _{IN} =V _{CE} =5.0V, V _{OUT(T)} =4.0V ⁽¹⁾ , I _{OUT} =30mA.	-	95	-	%	①
Efficiency ⁽⁴⁾	EFFI	V _{IN} =V _{CE} =3.6V, V _{OUT(T)} =3.3V ⁽¹⁾ , I _{OUT} =30mA.	-	95	-	%	①
Efficiency ⁽⁴⁾	EFFI	V _{IN} =V _{CE} =3.6V, V _{OUT(T)} =1.8V ⁽¹⁾ , I _{OUT} =30mA.	-	89	-	%	①
L _X SW "Pch" ON Resistance ⁽⁵⁾	R _{LXP}	V _{IN} =V _{CE} =5.0V, V _{OUT} =0V, I _{LX} =100mA.	-	0.4	0.65	Ω	④
L _X SW "Nch" ON Resistance	R _{LXN}	V _{IN} =V _{CE} =5.0V.	-	0.4 ⁽⁶⁾	-	Ω	-
Output Voltage Temperature Characteristics	$\frac{\Delta V_{OUT}}{V_{OUT} \cdot \Delta T_{opr}}$	-40°C ≤ T _{opr} ≤ 85°C.	-	±100	-	ppm/°C	②
CE "High" Voltage	V _{CEH}	V _{OUT} =0V. Resistor connected with L _X pin. Voltage which L _X pin changes "L" to "H" level while V _{CE} =0.2→1.5V.	1.2	-	6.0	V	⑤
CE "Low" Voltage	V _{CEL}	V _{OUT} =0V. Resistor connected with L _X pin. Voltage which L _X pin changes "H" to "L" level while V _{CE} =1.5→0.2V.	GND	-	0.3	V	⑤
CE "High" Current	I _{CEH}	V _{IN} =V _{CE} =5.0V, V _{OUT} =0V, L _X =Open.	-0.1	-	0.1	μA	⑤
CE "Low" Current	I _{CEL}	V _{IN} =5.0V, V _{CE} =V _{OUT} =0V, L _X =Open.	-0.1	-	0.1	μA	⑤
Short Protection Threshold Voltage	V _{SHORT}	Resistor connected with L _X pin. Voltage which L _X pin changes "H" to "L" level while V _{OUT} =V _{OUT(T)} +0.1V→0V ⁽¹⁾ .	0.4	0.5	0.6	V	②

Unless otherwise stated, V_{IN}=V_{CE}=5.0V

⁽¹⁾ V_{OUT(T)}=Nominal Output Voltage

⁽²⁾ V_{OUT(E)}=Effective Output Voltage

The actual output voltage value V_{OUT(E)} is the PFM comparator threshold voltage in the IC.

Therefore, the DC/DC circuit output voltage, including the peripheral components, is boosted by the ripple voltage average value.

Please refer to the characteristic example.

⁽³⁾ Not applicable to the products with V_{OUT(T)} < 2.15V since it is out of operational voltage range.

⁽⁴⁾ EFFI=[{(Output Voltage)×(Output Current)} / {(Input Voltage)×(Input Current)}]×100

⁽⁵⁾ L_X SW "Pch" ON resistance = (V_{IN} - V_{LX} pin measurement voltage) / 100mA

⁽⁶⁾ Designed value

■ ELECTRICAL CHARACTERISTICS (Continued)

●XC9265CxxxType、with CL Discharge Function

Ta=25°C

PARAMETER	SYMBOL	CONDITIONS	MIN.	TYP.	MAX.	UNITS	CIRCUIT
Input Voltage	V _{IN}	-	2.0	-	6.0	V	①
Output Voltage	V _{OUT(E)} ⁽²⁾	Resistor connected with L _X pin. Voltage which L _X pin changes “L” to “H” level while V _{OUT} is decreasing.	E1			V	②
UVLO Release Voltage	V _{UVLO(E)}	V _{CE} =V _{IN} , V _{OUT} =0V. Resistor connected with L _X pin. Voltage which L _X pin changes “L” to “H” level while V _{IN} is increasing.	1.65	1.8	1.95	V	②
UVLO Hysteresis Voltage	V _{HYS(E)}	V _{CE} =V _{IN} , V _{OUT} =0V. Resistor connected with L _X pin. V _{UVLO(E)} - Voltage which L _X pin changes “H” to “L” level while V _{IN} is decreasing.	0.11	0.15	0.24	V	②
Supply Current	I _q	V _{IN} =V _{CE} =V _{OUT(T)} +0.5V ⁽¹⁾ , V _{IN} =2.0V, if V _{OUT(T)} ≤1.5V ⁽¹⁾ , V _{OUT} =V _{OUT(T)} +0.5V ⁽¹⁾ , L _X =Open.	E2			μA	③
Standby Current	I _{STB}	V _{IN} =5.0V, V _{CE} =V _{OUT} =0V, L _X =Open.	-	0.1	1.0	μA	③
L _X SW “H” Leak Current	I _{LEAKH}	V _{IN} =5.0V, V _{CE} =V _{OUT} =0V, V _{LX} =0V.	-	0.1	1.0	μA	③
L _X SW “L” Leak Current	I _{LEAKL}	V _{IN} =5.0V, V _{CE} =V _{OUT} =0V, V _{LX} =5.0V.	-	0.1	1.0	μA	③
PFM Switching Current	I _{PFM}	V _{IN} =V _{CE} =V _{OUT(T)} +2.0V ⁽¹⁾ , I _{OUT} =10mA.	260	330	400	mA	①
Maximum Duty Ratio ⁽³⁾	MAXDTY	V _{IN} =V _{OUT} =V _{OUT(T)} ×0.95V ⁽¹⁾ , V _{CE} =1.2V Resistor connected with L _X pin.	100	-	-	%	②
Efficiency ⁽⁴⁾	EFFI	V _{IN} =V _{CE} =5.0V, V _{OUT(T)} =4.0V ⁽¹⁾ , I _{OUT} =30mA.	-	93	-	%	①
Efficiency ⁽⁴⁾	EFFI	V _{IN} =V _{CE} =3.6V, V _{OUT(T)} =3.3V ⁽¹⁾ , I _{OUT} =30mA.	-	93	-	%	①
Efficiency ⁽⁴⁾	EFFI	V _{IN} =V _{CE} =3.6V, V _{OUT(T)} =1.8V ⁽¹⁾ , I _{OUT} =30mA.	-	87	-	%	①
L _X SW “Pch” ON Resistance ⁽⁵⁾	R _{LXP}	V _{IN} =V _{CE} =5.0V, V _{OUT} =0V, I _{LX} =100mA.	-	0.4	0.65	Ω	④
L _X SW “Nch” ON Resistance	R _{LXN}	V _{IN} =V _{CE} =5.0V.	-	0.4 ⁽⁶⁾	-	Ω	-
Output Voltage Temperature Characteristics	$\frac{\Delta V_{OUT}}{(V_{OUT} \cdot \Delta T_{opr})}$	-40°C ≤ T _{opr} ≤ 85°C.	-	±100	-	ppm/°C	②
CE “High” Voltage	V _{CEH}	V _{OUT} =0V. Resistor connected with L _X pin. Voltage which L _X pin changes “L” to “H” level while V _{CE} =0.2→1.5V.	1.2	-	6.0	V	⑤
CE “Low” Voltage	V _{CEL}	V _{OUT} =0V. Resistor connected with L _X pin. Voltage which L _X pin changes “H” to “L” level while V _{CE} =1.5→0.2V.	GND	-	0.3	V	⑤
CE “High” Current	I _{CEH}	V _{IN} =V _{CE} =5.0V, V _{OUT} =0V, L _X =Open.	-0.1	-	0.1	μA	⑤
CE “Low” Current	I _{CEL}	V _{IN} =5.0V, V _{CE} =V _{OUT} =0V, L _X =Open.	-0.1	-	0.1	μA	⑤
Short Protection Threshold Voltage	V _{SHORT}	Resistor connected with L _X pin. Voltage which L _X pin changes “H” to “L” level while V _{OUT} =V _{OUT(T)} +0.1V→0V ⁽¹⁾ .	0.4	0.5	0.6	V	②
C _L Discharge	R _{DCHG}	V _{IN} =V _{OUT} =5.0V, V _{CE} =0V, L _X =Open.	55	80	105	Ω	③

Unless otherwise stated, V_{IN}=V_{CE}=5.0V

⁽¹⁾ V_{OUT(T)}=Nominal Output Voltage

⁽²⁾ V_{OUT(E)}=Effective Output Voltage

The actual output voltage value V_{OUT(E)} is the PFM comparator threshold voltage in the IC.

Therefore, the DC/DC circuit output voltage, including the peripheral components, is boosted by the ripple voltage average value.

Please refer to the characteristic example.

⁽³⁾ Not applicable to the products with V_{OUT(T)} < 2.15V since it is out of operational voltage range.

⁽⁴⁾ EFFI=[{(Output Voltage)×(Output Current)} / {(Input Voltage)×(Input Current)}]×100

⁽⁵⁾ L_X SW “Pch” ON resistance = (V_{IN} - V_{LX} pin measurement voltage) / 100mA

⁽⁶⁾ Designed value

ELECTRICAL CHARACTERISTICS (Continued)

●XC9265Dxxx Type, with CL Discharge function

Ta=25°C

PARAMETER	SYMBOL	CONDITIONS	MIN.	TYP.	MAX.	UNITS	CIRCUIT
Input Voltage	V _{IN}	-	2.0	-	6.0	V	①
Output Voltage	V _{OUT(E)} ⁽²⁾	Resistor connected with L _X pin. Voltage which L _X pin changes "L" to "H" level while V _{OUT} is decreasing.	E1			V	②
UVLO Release Voltage	V _{UVLO(E)}	V _{CE} =V _{IN} , V _{OUT} =0V. Resistor connected with L _X pin. Voltage which L _X pin changes "L" to "H" level while V _{IN} is increasing.	1.65	1.8	1.95	V	②
UVLO Hysteresis Voltage	V _{HYS(E)}	V _{CE} =V _{IN} , V _{OUT} =0V. Resistor connected with L _X pin. V _{UVLO(E)} - Voltage which L _X pin changes "H" to "L" level while V _{IN} is decreasing.	0.11	0.15	0.24	V	②
Supply Current	I _q	V _{IN} =V _{CE} =V _{OUT(T)} +0.5V ⁽¹⁾ , V _{IN} =2.0V, if V _{OUT(T)} ≤1.5V ⁽¹⁾ , V _{OUT} =V _{OUT(T)} +0.5V ⁽¹⁾ , L _X =Open.	E2			μA	③
Standby Current	I _{STB}	V _{IN} =5.0V, V _{CE} =V _{OUT} =0V, L _X =Open.	-	0.1	1.0	μA	③
L _X SW "H" Leak Current	I _{LEAKH}	V _{IN} =5.0V, V _{CE} =V _{OUT} =0V, V _{LX} =0V.	-	0.1	1.0	μA	③
L _X SW "L" Leak Current	I _{LEAKL}	V _{IN} =5.0V, V _{CE} =V _{OUT} =0V, V _{LX} =5.0V.	-	0.1	1.0	μA	③
PFM Switching Current	I _{PFM}	V _{IN} =V _{CE} =V _{OUT(T)} +2.0V ⁽¹⁾ , I _{OUT} =10mA.	115	180	250	mA	①
Maximum Duty Ratio ⁽³⁾	MAXDTY	V _{IN} =V _{OUT} =V _{OUT(T)} ×0.95V ⁽¹⁾ , V _{CE} =1.2V Resistor connected with L _X pin.	100	-	-	%	②
Efficiency ⁽⁴⁾	EFFI	V _{IN} =V _{CE} =5.0V, V _{OUT(T)} =4.0V ⁽¹⁾ , I _{OUT} =30mA.	-	95	-	%	①
Efficiency ⁽⁴⁾	EFFI	V _{IN} =V _{CE} =3.6V, V _{OUT(T)} =3.3V ⁽¹⁾ , I _{OUT} =30mA.	-	95	-	%	①
Efficiency ⁽⁴⁾	EFFI	V _{IN} =V _{CE} =3.6V, V _{OUT(T)} =1.8V ⁽¹⁾ , I _{OUT} =30mA.	-	89	-	%	①
L _X SW "Pch" ON Resistance ⁽⁵⁾	R _{LXP}	V _{IN} =V _{CE} =5.0V, V _{OUT} =0V, I _{LX} =100mA.	-	0.4	0.65	Ω	④
L _X SW "Nch" ON Resistance	R _{LXN}	V _{IN} =V _{CE} =5.0V.	-	0.4 ⁽⁶⁾	-	Ω	-
Output Voltage Temperature Characteristics	$\frac{\Delta V_{OUT}}{V_{OUT} \cdot \Delta T_{opr}}$	-40°C ≤ T _{opr} ≤ 85°C.	-	±100	-	ppm/°C	②
CE "High" Voltage	V _{CEH}	V _{OUT} =0V. Resistor connected with L _X pin. Voltage which L _X pin changes "L" to "H" level while V _{CE} =0.2→1.5V.	1.2	-	6.0	V	⑤
CE "Low" Voltage	V _{CEL}	V _{OUT} =0V. Resistor connected with L _X pin. Voltage which L _X pin changes "H" to "L" level while V _{CE} =1.5→0.2V.	GND	-	0.3	V	⑤
CE "High" Current	I _{CEH}	V _{IN} =V _{CE} =5.0V, V _{OUT} =0V, L _X =Open.	-0.1	-	0.1	μA	⑤
CE "Low" Current	I _{CEL}	V _{IN} =5.0V, V _{CE} =V _{OUT} =0V, L _X =Open.	-0.1	-	0.1	μA	⑤
Short Protection Threshold Voltage	V _{SHORT}	Resistor connected with L _X pin. Voltage which L _X pin changes "H" to "L" level while V _{OUT} =V _{OUT(T)} +0.1V→0V ⁽¹⁾ .	0.4	0.5	0.6	V	②
C _L Discharge	R _{DCHG}	V _{IN} =V _{OUT} =5.0V, V _{CE} =0V, L _X =Open.	55	80	105	Ω	③

Unless otherwise stated, V_{IN}=V_{CE}=5.0V

⁽¹⁾ V_{OUT(T)}=Nominal Output Voltage

⁽²⁾ V_{OUT(E)}=Effective Output Voltage

The actual output voltage value V_{OUT(E)} is the PFM comparator threshold voltage in the IC.

Therefore, the DC/DC circuit output voltage, including the peripheral components, is boosted by the ripple voltage average value.

Please refer to the characteristic example.

⁽³⁾ Not applicable to the products with V_{OUT(T)} < 2.15V since it is out of operational voltage range.

⁽⁴⁾ EFFI=[{(Output Voltage)×(Output Current)} / {(Input Voltage)×(Input Current)}]×100

⁽⁵⁾ L_X SW "Pch" ON resistance = (V_{IN} - V_{LX} pin measurement voltage) / 100mA

⁽⁶⁾ Designed value

■ ELECTRICAL CHARACTERISTICS (Continued)

XC9265 series voltage chart

SYMBOL	E1		E2	
PARAMETER	Output Voltage		Supply Current	
UNITS: V	UNITS: V		UNITS: μ A	
OUTPUT VOLTAGE	MIN.	MAX.	TYP.	MAX.
1.00	0.980	1.020	0.5	0.8
1.05	1.029	1.071		
1.10	1.078	1.122		
1.15	1.127	1.173		
1.20	1.176	1.224		
1.25	1.225	1.275		
1.30	1.274	1.326		
1.35	1.323	1.377		
1.40	1.372	1.428		
1.45	1.421	1.479		
1.50	1.470	1.530	0.5	0.9
1.55	1.519	1.581		
1.60	1.568	1.632		
1.65	1.617	1.683		
1.70	1.666	1.734		
1.75	1.715	1.785		
1.80	1.764	1.836		
1.85	1.813	1.887		
1.90	1.862	1.938		
1.95	1.911	1.989		
2.00	1.960	2.040	0.6	1.1
2.05	2.009	2.091		
2.10	2.058	2.142		
2.15	2.107	2.193		
2.20	2.156	2.244		
2.25	2.205	2.295		
2.30	2.254	2.346		
2.35	2.303	2.397		
2.40	2.352	2.448		
2.45	2.401	2.499		
2.50	2.450	2.550	0.7	1.5
2.55	2.499	2.601		
2.60	2.548	2.652		
2.65	2.597	2.703		
2.70	2.646	2.754		
2.75	2.695	2.805		
2.80	2.744	2.856		
2.85	2.793	2.907		

ELECTRICAL CHARACTERISTICS (Continued)

XC9265 series voltage chart

SYMBOL	E1		E2	
PARAMETER	Output Voltage		Supply Current	
UNITS: V	UNITS: V		UNITS: μ A	
OUTPUT VOLTAGE	MIN.	MAX.	TYP.	MAX.
2.90	2.842	2.958	0.7	1.5
2.95	2.891	3.009		
3.00	2.940	3.060	0.8	2.1
3.05	2.989	3.111		
3.10	3.038	3.162		
3.15	3.087	3.213		
3.20	3.136	3.264		
3.25	3.185	3.315		
3.30	3.234	3.366		
3.35	3.283	3.417		
3.40	3.332	3.468		
3.45	3.381	3.519		
3.50	3.430	3.570	1.5	3.0
3.55	3.479	3.621		
3.60	3.528	3.672		
3.65	3.577	3.723		
3.70	3.626	3.774		
3.75	3.675	3.825		
3.80	3.724	3.876		
3.85	3.773	3.927		
3.90	3.822	3.978		
3.95	3.871	4.029		
4.00	3.920	4.080		

TEST CIRCUITS

< Test Circuit No.1 >

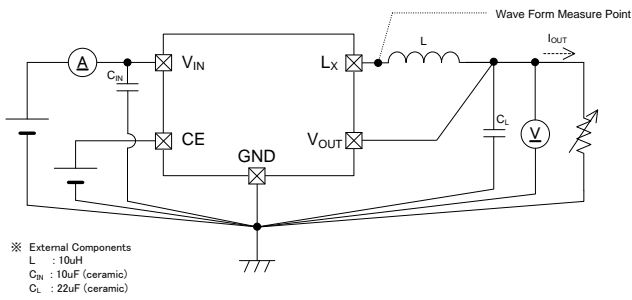

< Test Circuit No.2 >



< Test Circuit No.3 >



< Test Circuit No.4 >



< Test Circuit No.5 >

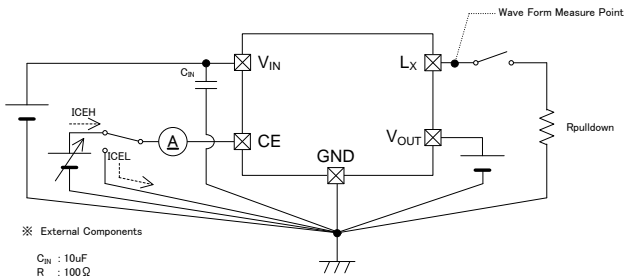

TYPICAL APPLICATION CIRCUIT



【Typical Examples】

	MANUFACTURE	PRODUCT NUMBER	VALUE
L	TDK	VLF302512M-100M	10 μ H
	Coilcraft	LPS3015-103MRB	10 μ H
	Murata	1239AS-H-100M	10 μ H
C _{IN}	TAIYO YUDEN	LMK107BJ106MA	10 μ F/10V
C _L	TAIYO YUDEN	JMK107BJ226MA	22 μ F/6.3V

* Take capacitance loss, withstand voltage, and other conditions into consideration when selecting components.

* Characteristics are dependent on deviations in the coil inductance value. Test fully using the actual device.

* A value of 10 μ H is recommended for the coil inductance.

* If a tantalum or electrolytic capacitor is used for the load capacitance C_L, ripple voltage will increase, and there is a possibility that operation will become unstable. Test fully using the actual device.

OPERATIONAL EXPLANATION

The XC9265 series consists of a reference voltage supply, PFM comparator, Pch driver Tr, Nch synchronous rectification switch Tr, current sensing circuit, PFM control circuit, CE control circuit, and others. (Refer to the block diagram below.)



XC9265Axxx/XC9265Bxxx



XC9265Cxxx/XC9265xxx

An ultra-low quiescent current circuit and synchronous rectification enable a significant reduction of dissipation in the IC, and the IC operates with high efficiency at both light loads and heavy loads. Current limit PFM is used for the control method, and even when switching current superposition occurs, increases of output voltage ripple are suppressed, allowing use over a wide voltage and current range. The IC is compatible with low-capacitance ceramic capacitors, and a small, high-performance step-down DC-DC converter can be created.

The actual output voltage $V_{OUT(E)}$ in the electrical characteristics is the threshold voltage of the PFM comparator in the block diagram. Therefore the average output voltage of the step-down circuit, including peripheral components, depends on the ripple voltage. Before use, test fully using the actual device.

$V_N=V_{CE}=3.6V$, $V_{OUT}=1.8V$, $I_{OUT}=5mA$, $L=10\mu H$, $C_L=22\mu F$, $T_a=25^\circ C$

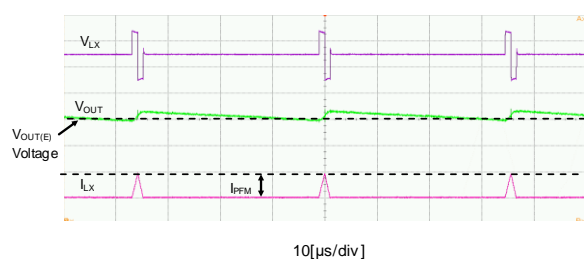

$V_N=V_{CE}=3.6V$, $V_{OUT}=1.8V$, $I_{OUT}=30mA$, $L=10\mu H$, $C_L=22\mu F$, $T_a=25^\circ C$

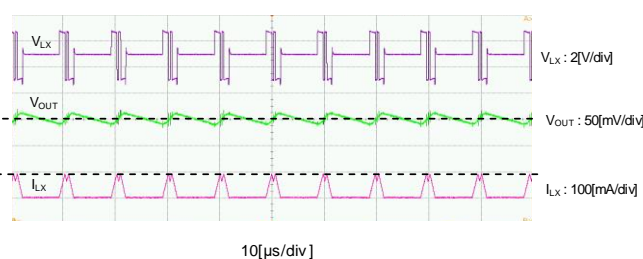

<Reference voltage supply (V_{REF})>

Reference voltage for stabilization of the output voltage of the IC.

<PFM control>

(1) The feedback voltage (FB voltage) is the voltage that results from dividing the output voltage with the IC internal dividing resistors R_{FB1} and R_{FB2} . The PFM comparator compares this FB voltage to V_{REF} . When the FB voltage is lower than V_{REF} , the PFM comparator sends a signal to the buffer driver through the PFM control circuit to turn on the Pch driver Tr. When the FB voltage is higher than V_{REF} , the PFM comparator sends a signal to prevent the Pch driver Tr from turning on.

(2) When the Pch driver Tr is on, the current sense circuit monitors the current that flows through the Pch driver Tr connected to the Lx pin. When the current reaches the set PFM switching current (I_{PFM}), the current sense circuit sends a signal to the buffer driver through the PFM control circuit. This signal turns off the Pch driver Tr and turns on the Nch synchronous rectification switch Tr.

(3) The on time (off time) of the Nch synchronous rectification switch Tr is dynamically optimized inside the IC. After the off time elapses and the PFM comparator detects that the V_{OUT} voltage is higher than the set voltage, the PFM comparator sends a signal to the PFM control circuit that prevents the Pch driver Tr from turning on. However, if the V_{OUT} voltage is lower than the set voltage, the PFM comparator starts Pch driver Tr on.

By continuously adjusting the interval of the linked operation of (1), (2) and (3) above in response to the load current, the output voltage is stabilized with high efficiency from light loads to heavy loads

OPERATIONAL EXPLANATION (Continued)

<PFM Switching Current >

The PFM switching current monitors the current that flows through the Pch driver Tr, and is a value that limits the Pch driver Tr current.

The Pch driver Tr remains on until the coil current reaches the PFM switching current (I_{PFM}). An approximate value for this on-time t_{ON} can be calculated using the following equation:

$$t_{ON} = L \times I_{PFM} / (V_{IN} - V_{OUT})$$

<Maximum on-time function>

To avoid excessive ripple voltage in the event that the coil current does not reach the PFM switching current within a certain interval even though the Pch driver Tr has turned on and the FB voltage is above V_{REF} , the Pch driver Tr can be turned off at any timing using the maximum on-time function of the PFM control circuit. If the Pch driver Tr turns off by the maximum on-time function instead of the current sense circuit, the Nch synchronous rectification switch Tr will not turn on and the coil current will flow to the V_{OUT} pin by means of the parasite diode of the Nch synchronous rectification switch Tr.

<Through mode>

When the V_{IN} voltage is lower than the output voltage, through mode automatically activates and the Pch driver Tr stays on continuously.

(1) In through mode, when the load current is increased and the current that flows through the Pch driver Tr reaches a load current that is several tens of mA lower than the set PFM switching current (I_{PFM}), the current sense circuit sends a signal through the PFM control circuit to the buffer driver. This signal turns off the Pch driver Tr and turns on the Nch synchronous rectification switch Tr.

(2) After the on-time (off-time) of the Nch synchronous rectification switch Tr, the Pch driver Tr turns on until the current reaches the set PFM switching current (I_{PFM}) again.

If the load current is large as described above, operations (1) and (2) above are repeated. If the load current is several tens of mA lower than the PFM switching current (I_{PFM}), the Pch driver Tr stays on continuously.

< V_{IN} start mode>

When the V_{IN} voltage rises, V_{IN} start mode stops the short-circuit protection function during the interval until the FB voltage approaches V_{REF} . After the V_{IN} voltage rises and the FB voltage approaches V_{REF} by step-down operation, V_{IN} start mode is released. In order to prevent an excessive rush current while V_{IN} start mode is activated, the coil current flows to the V_{OUT} pin by means of the parasitic diode of the Nch synchronous rectification Tr. In V_{IN} start mode as well, the coil current is limited by the PFM switching current.

<Short protection function>

The short-circuit protection function monitors the V_{OUT} pin voltage, and if the V_{OUT} pin voltage drops below the Short Protection Threshold Voltage (V_{SHORT}) due to a short circuit or overcurrent, the short circuit protection function operates.

When the short-circuit protection function is activated, the Pch driver Tr and Nch Synchronous Switch Tr are held off. If the V_{OUT} pin voltage exceeds the Short Protection Threshold Voltage (V_{SHORT}) after the short-circuit protection function is activated, normal operation resumes.

To cancel the short-circuit protection function, it is necessary to start the IC after putting the IC in the standby state with the CE function, or to raise the input voltage after setting the input voltage below the UVLO detection voltage ($V_{UVLO(E)} - V_{HYS(E)}$).

■ OPERATIONAL EXPLANATION (Continued)

<UVLO function>

When the V_{IN} pin voltage drops below the UVLO detection voltage, the IC stops switching operation at any selected timing, turns off the Pch driver Tr and Nch synchronous rectification switch Tr (UVLO mode). When the V_{IN} pin voltage recovers and rises above the UVLO release voltage, the IC restarts operation.

< C_L discharge function>

On the XC9265 series, a C_L discharge function is available as an option (XC9265C/XC9265D types). This function enables quick discharging of the C_L load capacitance when “L” voltage is input into the CE pin by the Nch Tr connected between the V_{OUT} -GND pins, or in UVLO mode. This prevents malfunctioning of the application in the event that a charge remains on C_L when the IC is stopped. The discharge time is determined by C_L and the C_L discharge resistance R_{DCHG} , including the Nch Tr (refer to the diagram below). Using this time constant $\tau = C_L \times R_{DCHG}$, the discharge time of the output voltage is calculated by means of the equation below.

$$V = V_{OUT} \times e^{-t/\tau}, \text{ or in terms of } t, t = \tau \ln(V_{OUT} / V)$$

V	: Output voltage after discharge
V_{OUT}	: Set output voltage
t	: Discharge time
C_L	: Value of load capacitance (C_L)
R_{DCHG}	: Value of C_L discharge resistance Varies by power supply voltage.
T	: $C_L \times R_{DCHG}$



The C_L discharge function is not available on the XC9265A/XC9265B types.

NOTE ON USE

1. Be careful not to exceed the absolute maximum ratings for externally connected components and this IC.
2. The DC/DC converter characteristics greatly depend not only on the characteristics of this IC but also on those of externally connected components, so refer to the specifications of each component and be careful when selecting the components. Be especially careful of the characteristics of the capacitor used for the load capacity C_L and use a capacitor with B characteristics (JIS Standard) or an X7R/X5R (EIA Standard) ceramic capacitor.
3. Use a ground wire of sufficient strength. Ground potential fluctuation caused by the ground current during switching could cause the IC operation to become unstable, so reinforce the area around the GND pin of the IC in particular.
4. Mount the externally connected components in the vicinity of the IC. Also use short, thick wires to reduce the wire impedance.
5. When the voltage difference between V_{IN} and V_{OUT} is small, switching energy increases and there is a possibility that the ripple voltage will be too large. Before use, test fully using the actual device.
6. The CE pin does not have an internal pull-up or pull-down, etc. Apply the prescribed voltage to the CE pin.
7. If other than the recommended inductance and capacitance values are used, excessive ripple voltage or a drop in efficiency may result.
8. If other than the recommended inductance and capacitance values are used, a drop in output voltage when the load is excessive may cause the short-circuit protection function to activate. Before use, test fully using the actual device.
9. At high temperature, excessive ripple voltage may occur and cause a drop in output voltage and efficiency. Before using at high temperature, test fully using the actual device
10. At light loads or when IC operation is stopped, leakage current from the Pch driver T_r may cause the output voltage to rise.
11. The average output voltage may vary due to the effects of output voltage ripple caused by the load current. Before use, test fully using the actual device.
12. If the C_L capacitance or load current is large, the output voltage rise time will lengthen when the IC is started, and coil current overlay may occur during the interval until the output voltage reaches the set voltage (refer to the diagram below).

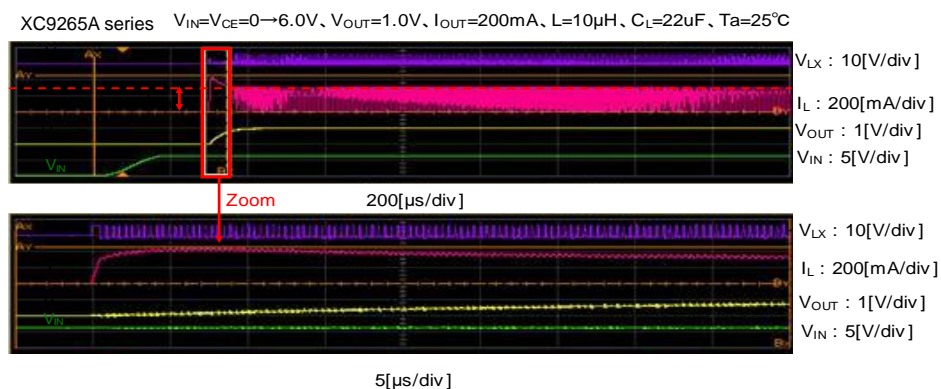

13. When the IC is started, the short-circuit protection function does not operate during the interval until the V_{OUT} voltage reaches a value near the set voltage.
14. If the IC is started at a V_{IN} voltage that activates through mode, it is possible that the short-circuit protection function will not operate. Before use, test fully using the actual device.
15. If the load current is excessively large when the IC is started, it is possible that the V_{OUT} voltage will not rise to the set voltage. Before use, test fully using the actual device.

■ NOTE ON USE (Continued)

16. In actual operation, the maximum on-time depends on the peripheral components, input voltage, and load current. Before use, test fully using the actual device.
17. When the V_{IN} voltage is turned on and off continuously, excessive rush current may occur while the voltage is on. Before use, test fully using the actual device.
18. When the V_{IN} voltage is high, the Pch driver may change from on to off before the coil current reaches the PFM switching current (I_{PFM}), or before the maximum on-time elapses. Before use, test fully using the actual device.
19. When the IC change to the Through Mode at light load, the supply current of this IC can increase in some cases.
20. For temporary, transitional voltage drop or voltage rising phenomenon, the IC is liable to malfunction should the ratings be exceeded.
21. Torex places an importance on improving our products and their reliability.
We request that users incorporate fail-safe designs and post-aging protection treatment when using Torex products in their systems.
22. The UVLO function can be activated when the UVLO hysteresis width gets to about 0mV and after several tens ms elapses at light loads. Before use, test fully using the actual device.

NOTE ON USE (Continued)

● Instructions of pattern layouts

1. To suppress fluctuations in the V_{IN} potential, connect a bypass capacitor (C_{IN}) in the shortest path between the V_{IN} pin and ground pin.
2. Please mount each external component as close to the IC as possible.
3. Wire external components as close to the IC as possible and use thick, short connecting traces to reduce the circuit impedance.
4. Make sure that the ground traces are as thick as possible, as variations in ground potential caused by high ground currents at the time of switching may result in instability of the IC.
5. Internal driver transistors bring on heat because of the transistor current and ON resistance of the driver transistors.

● Recommended Pattern Layout (USP-6EL)



Top view



Bottom view

● Recommended Pattern Layout (SOT-25)



Top view



Bottom view

TYPICAL PERFORMANCE CHARACTERISTICS

(1) Efficiency vs. Output Current

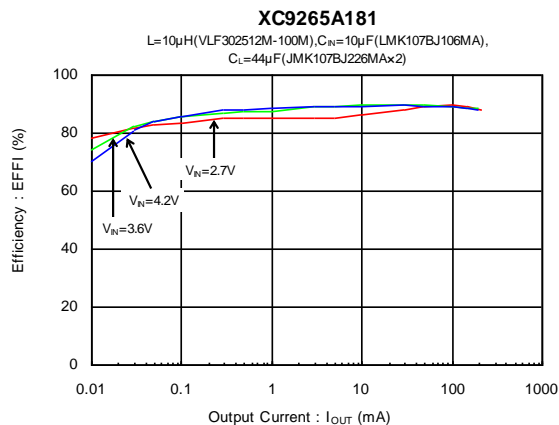

TYPICAL PERFORMANCE CHARACTERISTICS (Continued)

(1) Efficiency vs. Output Current

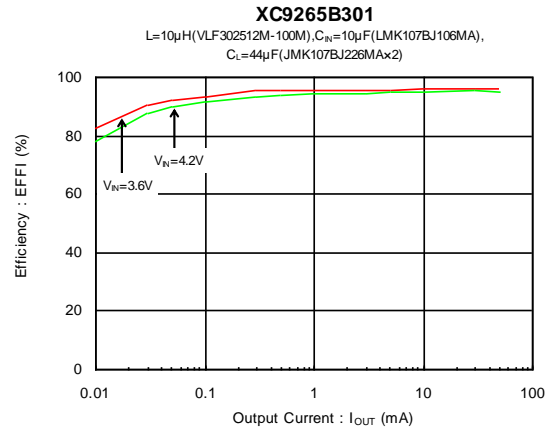

(2) Output Voltage vs. Output Current

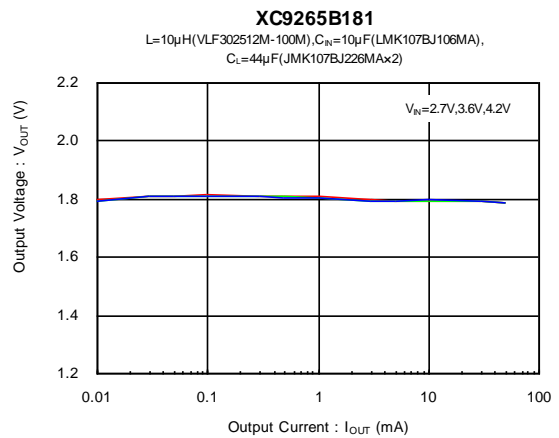
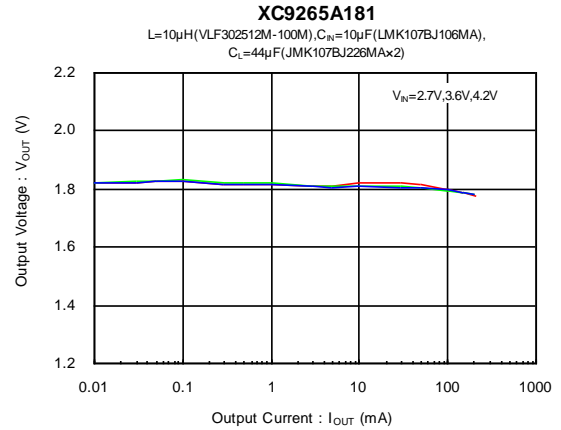

TYPICAL PERFORMANCE CHARACTERISTICS (Continued)

(2) Output Voltage vs. Output Current

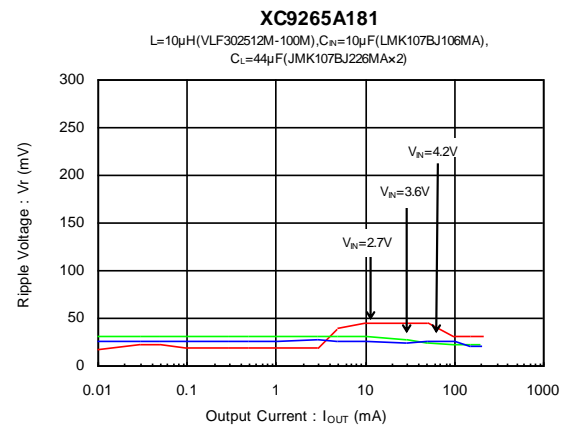
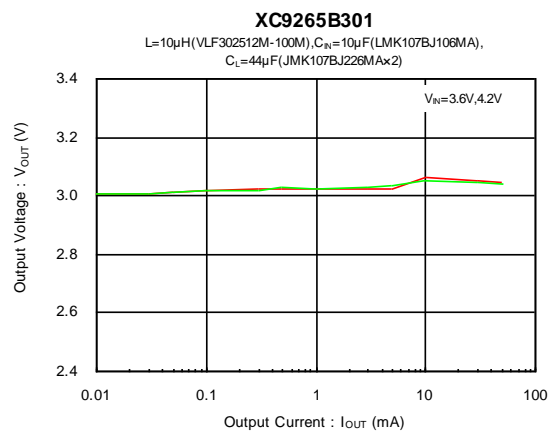
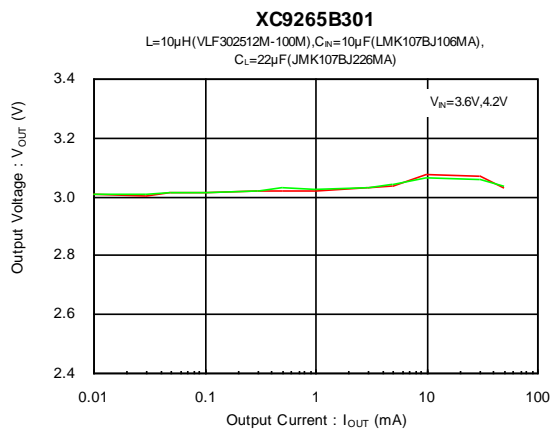
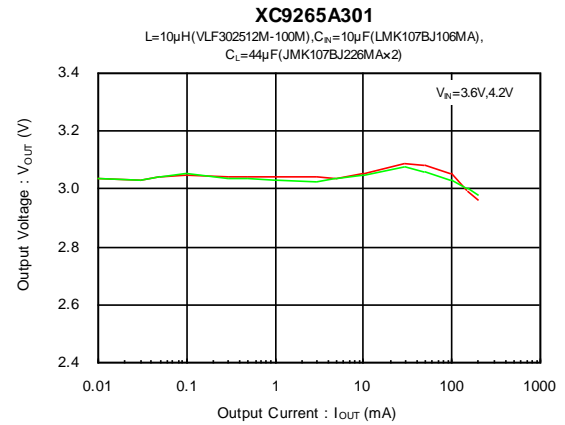
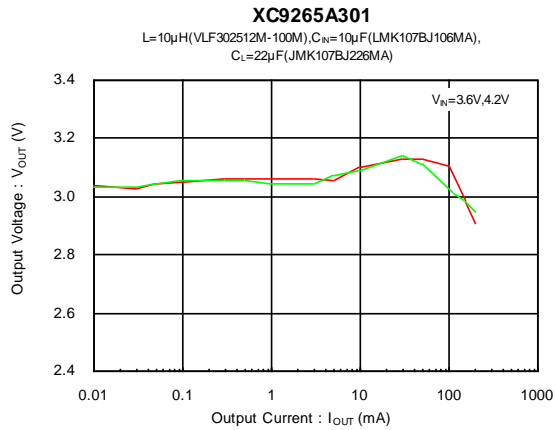

TYPICAL PERFORMANCE CHARACTERISTICS (Continued)

(3) Ripple Voltage vs. Output Current



■ TYPICAL PERFORMANCE CHARACTERISTICS (Continued)

(4) Output Voltage Vs. Ambient Temperature



(5) Supply Current vs. Ambient Temperature



(6) Stand-by Current vs. Ambient Temperature



TYPICAL PERFORMANCE CHARACTERISTICS (Continued)

(7) UVLO Release Voltage vs. Ambient Temperature

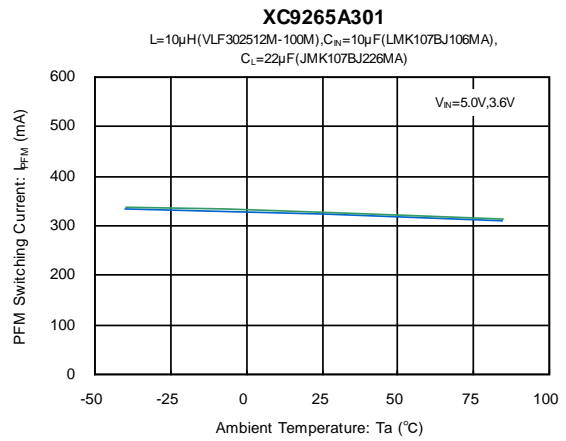
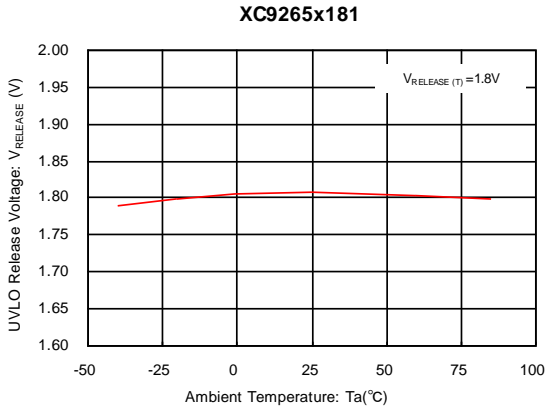

(8) PFM Switching Current vs. Ambient Temperature

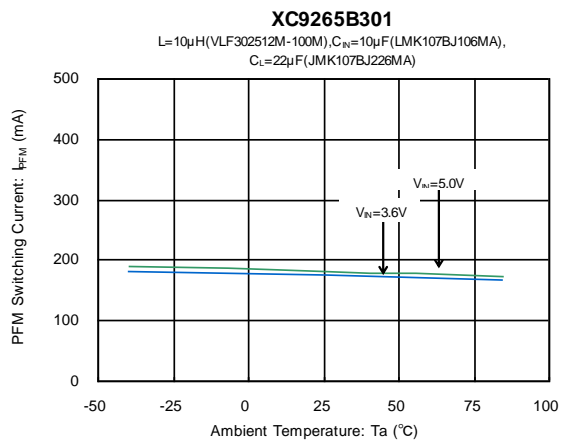

TYPICAL PERFORMANCE CHARACTERISTICS (Continued)

(9) Maximum Frequency vs. Ambient Temperature

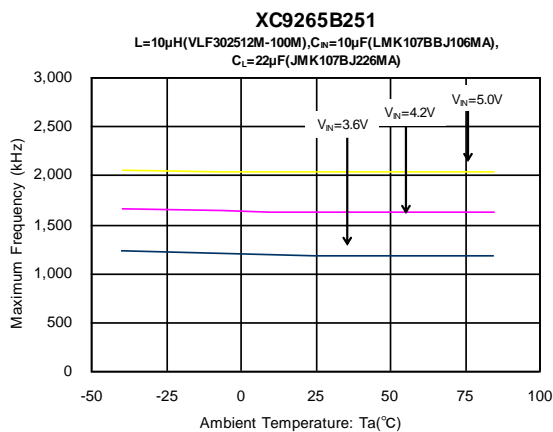
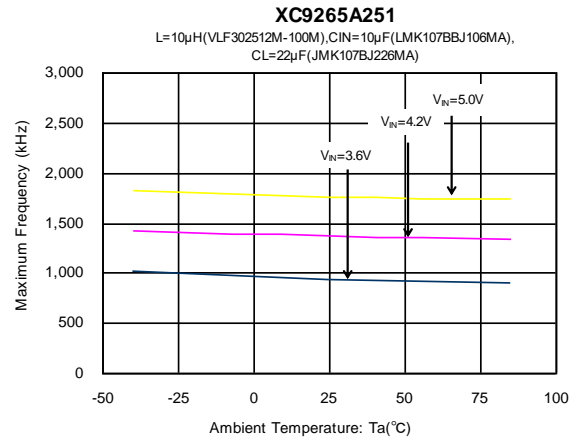
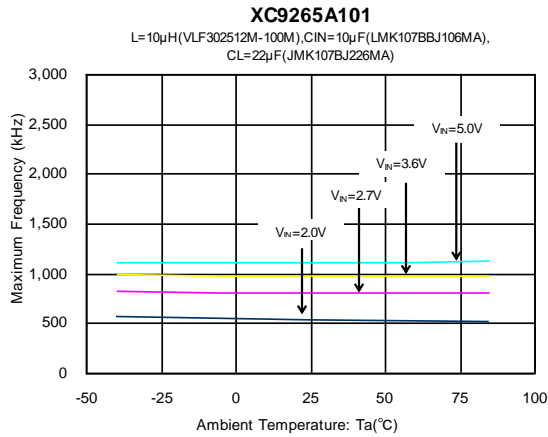

TYPICAL PERFORMANCE CHARACTERISTICS (Continued)

(10) Pch Driver ON Resistance vs. Ambient Temperature



(11) Nch Driver ON Resistance vs. Ambient Temperature



(12) Lx SW "H" Leakage Current vs. Ambient Temperature



(13) Lx SW "L" Leakage Current vs. Ambient Temperature



(14) CE "High" Voltage vs. Ambient Temperature



(15) CE "Low" Voltage vs. Ambient Temperature



■ TYPICAL PERFORMANCE CHARACTERISTICS (Continued)

(16) CL Discharge vs. Ambient Temperature



(17) Short Protection Threshold vs. Ambient Temperature



(18) Rising Output Voltage

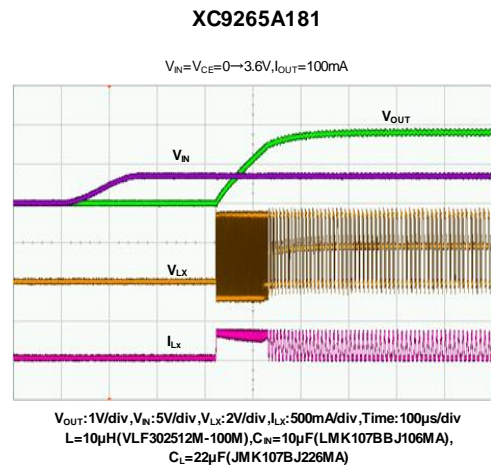

TYPICAL PERFORMANCE CHARACTERISTICS (Continued)

(19) Load Transient Response

XC9265A301



XC9265A301



XC9265B301



XC9265B301



XC9265A181



XC9265A181



■ TYPICAL PERFORMANCE CHARACTERISTICS (Continued)

(19) Load Transient Response



■ PACKAGING INFORMATION

For the latest package information go to, www.torexsemi.com/technical-support/packages

PACKAGE	OUTLIN / LAND PATTERN	THERMAL CHARACTERISTICS
SOT-25	SOT-25 PKG	SOT-25 Power Dissipation
USP-6EL(DAF)	USP-6EL PKG	USP-6EL Power Dissipation

MARKING RULE

● SOT-25(Under dot)



USP-6EL
● USP-6EL

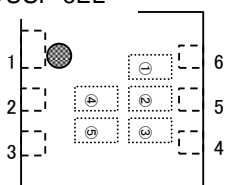

MARK① represents product series

MARK	PRODUCT SERIES
C	XC9265A/B/C/D*****-G

※SOT-25 Under dot

MARK② represents output voltage

MARK	OUTPUT VOLTAGE								PRODUCT SERIES
0	-	1.9	2.9	3.9	-	1.95	2.95	3.95	XC9265A/B*****-G
1	1.0	2.0	3.0	4.0	1.05	2.05	3.05	-	
2	1.1	2.1	3.1	-	1.15	2.15	3.15	-	
3	1.2	2.2	3.2	-	1.25	2.25	3.25	-	
4	1.3	2.3	3.3	-	1.35	2.35	3.35	-	
5	1.4	2.4	3.4	-	1.45	2.45	3.45	-	
6	1.5	2.5	3.5	-	1.55	2.55	3.55	-	
7	1.6	2.6	3.6	-	1.65	2.65	3.65	-	
8	1.7	2.7	3.7	-	1.75	2.75	3.75	-	
9	1.8	2.8	3.8	-	1.85	2.85	3.85	-	
A	-	1.9	2.9	3.9	-	1.95	2.95	3.95	XC9265C/D*****-G
B	1.0	2.0	3.0	4.0	1.05	2.05	3.05	-	
C	1.1	2.1	3.1	-	1.15	2.15	3.15	-	
D	1.2	2.2	3.2	-	1.25	2.25	3.25	-	
E	1.3	2.3	3.3	-	1.35	2.35	3.35	-	
F	1.4	2.4	3.4	-	1.45	2.45	3.45	-	
H	1.5	2.5	3.5	-	1.55	2.55	3.55	-	
K	1.6	2.6	3.6	-	1.65	2.65	3.65	-	
L	1.7	2.7	3.7	-	1.75	2.75	3.75	-	
M	1.8	2.8	3.8	-	1.85	2.85	3.85	-	

MARK③ represents output voltage range

MARK	OUTPUT VOLTAGE	PRODUCT SERIES
A	1.0~1.8V	XC9265A/C**1**-G
B	1.9~2.8V	
C	2.9~3.8V	
D	3.9~4.0V	
E	1.0~1.8V	XC9265B/D**1**-G
F	1.9~2.8V	
H	2.9~3.8V	
K	3.9~4.0V	
P	1.05~1.85V	XC9265A/C**B**-G
R	1.95~2.85V	
S	2.95~3.85V	
T	3.95V	
U	1.05~1.85V	XC9265B/D**B**-G
V	1.95~2.85V	
X	2.95~3.85V	
Y	3.95V	

MARK④⑤ represents production lot number

01~09, 0A~0Z, 11~9Z, A1~A9, AA~AZ, B1~ZZ

(G, I, J, O, Q, W excluded and no character inversion used)