

## 2ch. Step-Down / Inverting DC/DC Controller IC

☆GreenOperation-Compatible

### ■GENERAL DESCRIPTION

XC9505 series are PWM controlled, PWM/PFM switching 2 channel (step-down and inverting) DC/DC controller ICs. With 0.9V of internal standard voltage supply, and using externally connected components, the output 1 voltage (step-down DC/DC controller) can be set freely within a range of 0.9V to 6.0V. Since output 2 (inverting DC/DC controller) has a built-in 0.9V reference voltage (accuracy  $\pm 2\%$ ), a negative voltage can be set with the external components.

With a 180 kHz frequency, the size of the external components can be reduced. Switching frequencies of 300 kHz and 500 kHz are also available as custom designed products.

The control of the XC9505 series can be switched between PWM control and PWM/PFM automatic switching control using external signals. Control switches from PWM to PFM during light loads when automatic switching is selected and the series is highly efficient from light loads through to large output currents. Noise is easily reduced with PWM control since the frequency is fixed.

The series gives freedom of control selection so that control suited to the application can be selected. Soft-start time is internally set to 10ms (output1) which offers protection against rush currents and voltage overshoot when the power is switched on.

### ■APPLICATIONS

- PDAs
- Palm top computers
- Digital cameras
- Various power supplies

### ■FEATURES

#### 2 ch. DC/DC Controller (Step-Down / Inverting)

##### <Output 1: Step-Down DC/DC Controller>

Output Voltage Range : 0.9V ~ 6.0V (set by FB1 pin)  
 Output Current : More than 1000mA  
 ( $V_{IN}=5.0V, V_{OUT}=3.3V$ )

Maximum Duty Cycle : 100%

Soft-Start Internally Set-Up

##### <Output 2: Inverting DC/DC Controller>

Output Voltage Range : -30V ~ 0V (set by FB2 pin)  
 Output Current : More than -100mA  
 ( $V_{IN}=5.0V, V_{OUT}= -3.3V$ )

Maximum Duty Cycle : 80% (TYP.)

##### <Common>

Operating Voltage Range : 2.0V ~ 10.0V

Oscillation Frequency : 180kHz ( $\pm 15\%$ )

\* 300kHz, 500kHz custom

Control Method : PWM or PWM/PFM Selectable

Stand-by Function : 3.0  $\mu$ A (MAX.)

Packages : MSOP-10, USP-10

Environmentally Friendly : EU RoHS Compliant, Pb Free

### ■TYPICAL APPLICATION CIRCUIT

<XC9505B092A Input: 2 cell,  $V_{OUT}$ : 3.3V,  $V_{OUT}$ : -5.0V >

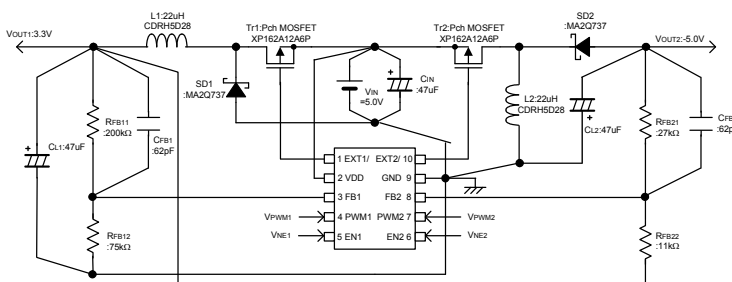

### ■TYPICAL PERFORMANCE CHARACTERISTICS

- Efficiency vs. Output Current

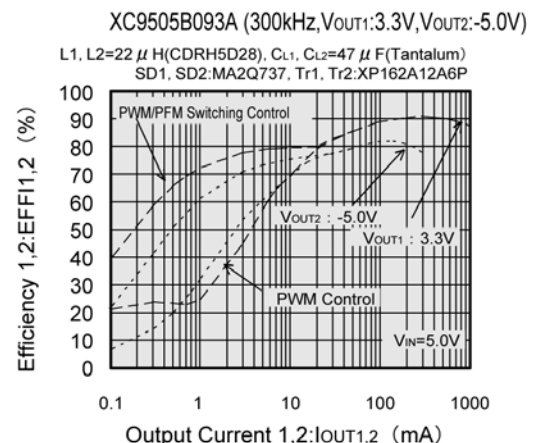

## ■ PIN CONFIGURATION

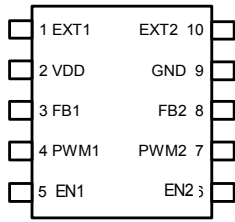

MSOP-10  
(TOP VIEW)

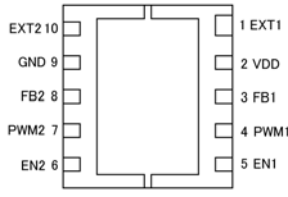

USP-10  
(BOTTOM VIEW)

## ■ PIN ASSIGNMENT

| PIN NUMBER | PIN NAME | FUNCTIONS  |
|------------|----------|--|
| 1          | EXT 1    | Channel 1: External Transistor Drive Pin <Connected to P-ch Power MOSFET Gate>   |
| 2          | VDD      | Supply Voltage   |
| 3          | FB1      | Channel 1: Output Voltage Monitor Feedback Pin <Threshold value: 0.9V. Output voltage can be set freely by connecting split resistors between VOUT1 and Ground.> |
| 4          | PWM1     | Channel 1: PWM/PFM Switching Pin <Control Output 1. PWM control when connected to VDD, PWM / PFM auto switching when connected to Ground. >                      |
| 5          | EN1      | Channel 1: Enable Pin <Connected to Ground when Output 1 is in stand-by mode. Connected to VDD when Output 1 is active. EXT1 is high when in stand-by mode.>     |
| 6          | EN2      | Channel 2: Enable Pin <Connected to Ground when Output 2 is in stand-by mode. Connected to VDD when Output 2 is active. EXT2/ is high when in stand-by mode.>    |
| 7          | PWM2     | Channel 2: PWM/PFM Switching Pin <Control Output 2. PWM control when connected to VDD, PWM / PFM auto switching when connected to Ground.>                       |
| 8          | FB2      | Channel 2: Output Voltage Monitor Feedback Pin <Threshold value: 0.9V. Output voltage can be set freely by connecting split resistors between VOUT2 and VOUT1.>  |
| 9          | GND      | Ground   |
| 10         | EXT2/    | Channel 2: External Transistor Drive Pin <Connected to P-ch Power MOSFET Gate>   |

## ■ PRODUCT CLASSIFICATION

### ● Ordering Information

XC9505①②③④⑤⑥-⑦<sup>(\*)</sup>

| MARK | ITEM                     | SYMBOL | DESCRIPTION                |
|------|--------------------------|--------|----------------------------|
| ①    | Type of DC/DC Controller | B      | Standard type (10 pin)     |
| ②③   | Output Voltage           | 09     | FB products→②=0, ③=9 fixed |
| ④    | Oscillation Frequency    | 2      | 180kHz                     |
|      |                          | 3      | 300kHz (custom)            |
|      |                          | 5      | 500kHz (custom)            |
| ⑤⑥-⑦ | Packages<br>(Order Unit) | AR     | MSOP-10 (1,000/Reel)       |
|      |                          | AR-G   | MSOP-10 (1,000/Reel)       |
|      |                          | DR     | USP-10 (3,000/Reel)        |
|      |                          | DR-G   | USP-10 (3,000/Reel)        |

<sup>(\*)</sup> The "-G" suffix indicates that the products are Halogen and Antimony free as well as being fully RoHS compliant.

## ■ BLOCK DIAGRAM

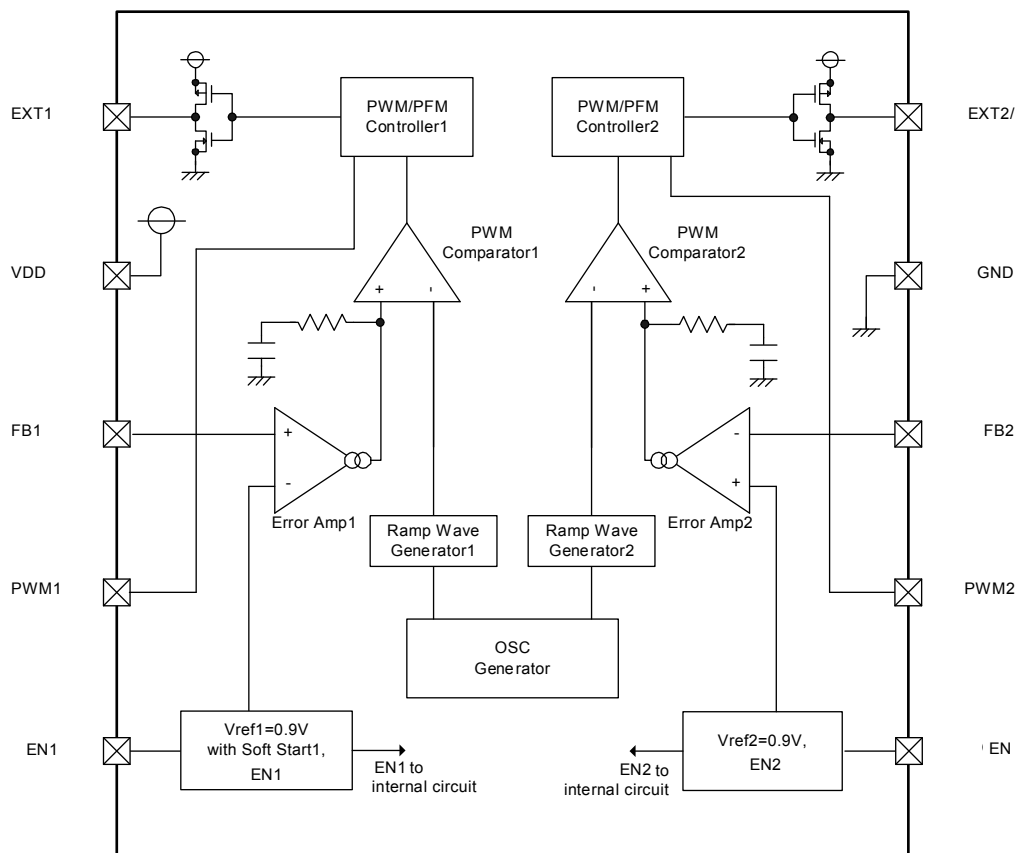

## ■ ABSOLUTE MAXIMUM RATINGS

Ta=25°C

| PARAMETER                   | SYMBOL  | RATINGS           | UNITS |
|-----------------------------|---------|-------------------|-------|
| VDD Pin Voltage             | VDD     | - 0.3 ~ 12.0      | V     |
| FB1, 2 Pin Voltage          | VFB     | - 0.3 ~ 12.0      | V     |
| EN1, 2 Pin Voltage          | VEN     | - 0.3 ~ 12.0      | V     |
| PWM1, 2 Pin Voltage         | VPWM    | - 0.3 ~ 12.0      | V     |
| EXT1, 2 Pin Voltage         | VEXT    | - 0.3 ~ VDD + 0.3 | V     |
| EXT1, 2 Pin Current         | IEXT    | ± 100             | mA    |
| Power Dissipation           | MSOP-10 | Pd                | mW    |
|                             | USP-10  |                   |       |
| Operating Temperature Range | Topr    | - 40 ~ + 85       | °C    |
| Storage Temperature Range   | Tstg    | - 55 ~ + 125      | °C    |

## ELECTRICAL CHARACTERISTICS

XC9505B092A

Common Characteristics

Ta=25°C

| PARAMETER                | SYMBOL  | CONDITIONS                     | MIN.                  | TYP.                  | MAX.              | UNITS | CIRCUIT |
|--------------------------|---------|--------------------------------|-----------------------|-----------------------|-------------------|-------|---------|
| Supply Voltage           | VDD     |                                | 2.0                   | -                     | 10.0              | V     | -       |
| Output Voltage Range(*1) | VOUTSET | VDD ≥ 2.0V, IOUT1, 2=1mA       | $\frac{VOUT1}{VOUT2}$ | $\frac{VOUT1}{VOUT2}$ | $\frac{VIN}{0.0}$ | V     | ①       |
| Supply Current 1         | IDD1    | FB=0V, FB2=1.2V                | -                     | 80                    | 160               | μA    | ②       |
| Supply Current 1-1       | IDD1-1  | EN1=3.0V, EN2=0, FB1=0V        | -                     | 50                    | 110               | μA    | ②       |
| Supply Current 1-2       | IDD1-2  | EN2=3.0V, EN1=0, FB2=1.2V      | -                     | 60                    | 120               | μA    | ②       |
| Supply Current 1-3       | IDD1-3  | FB1=0V, FB2=0V                 | -                     | 70                    | 120               | μA    | ②       |
| Supply Current 1-4       | IDD1-4  | FB1=1.2V, FB2=1.2V             | -                     | 80                    | 150               | μA    | ②       |
| Supply Current 2         | IDD2    | FB1=1.2V, FB2=0V               | -                     | 70                    | 130               | μA    | ②       |
| Stand-by Current         | ISTB    | Same as IDD1, EN1=EN2=0V       | -                     | 1.0                   | 3.0               | μA    | ②       |
| Oscillation Frequency    | fosc    | Same as IDD1                   | 153                   | 180                   | 207               | kHz   | ②       |
| EN1, 2 "High" Voltage    | VENH    | FB1=0V, FB2=3.0V               | 0.65                  | -                     | -                 | V     | ②       |
| EN1, 2 "Low" Voltage     | VENL    | FB1=0V, FB2=3.0V               | -                     | -                     | 0.20              | V     | ②       |
| EN1, 2 "High" Current    | IENH    | FB1=3.0V, FB2=0V               | -                     | -                     | 0.50              | μA    | ②       |
| EN1, 2 "Low" Current     | IENL    | EN1, 2=0V, FB1=3.0V, FB2=0V    | -                     | -                     | -0.50             | μA    | ②       |
| PWM1, 2 "High" Current   | IPWMH   | FB1=3.0V, FB2=0V, PWM1, 2=3.0V | -                     | -                     | 0.50              | μA    | ②       |
| PWM1, 2 "Low" Current    | IPWML   | FB1=3.0V, FB2=0V, PWM1, 2=0V   | -                     | -                     | -0.50             | μA    | ②       |
| FB1, 2 "High" Current    | IFBH    | FB1=3.0V, FB2=0.8V             | -                     | -                     | 0.50              | μA    | ②       |
| FB1, 2 "Low" Current     | VFBL    | FB1=1.0V, FB2=0V               | -                     | -                     | -0.50             | μA    | ②       |

Unless otherwise stated, VDD=3.0V, PWM1, 2=3.0V, EN1, 2 = 3.0V

Output 1 Characteristics

Step-Down Controller

Ta=25°C

| PARAMETER                 | SYMBOL  | CONDITIONS                            | MIN.  | TYP.  | MAX.  | UNITS | CIRCUIT |
|---------------------------|---------|---------------------------------------|-------|-------|-------|-------|---------|
| FB1 Voltage               | VFB1    | VDD=3.0V, VIN=1.5V, IOUT1=10mA        | 0.882 | 0.900 | 0.918 | V     | ③       |
| Minimum Operating Voltage | VINmin1 |                                       | -     | -     | 2.0   | V     | ①       |
| Maximum Duty Ratio1       | MINDTY1 | Same as IDD1                          | 100   | -     | -     | %     | ②       |
| Minimum Duty Ratio1       | MAXDTY1 | Same as IDD2                          | -     | -     | 0     | %     | ②       |
| PFM Duty Ratio1           | PFMDTY1 | No Load, VPWM1=0V                     | 22    | 30    | 38    | %     | ④       |
| Efficiency1 (*2)          | EFFI1   | IOUT1= 250mA, Pch MOSFET: XP162A12A6P | -     | 92    | -     | %     | ④       |
| Soft-Start Time1          | tss1    | VOUT1 × 0.95V, EN1=0V → 0.65V         | 5.0   | 10.0  | 20.0  | ms    | ④       |
| EXT1 "High" ON Resistance | REXTBH1 | FB1=0V, EXT1=VDD -0.4V                | -     | 28    | 47    | Ω     | ⑤       |
| EXT1 "Low" ON Resistance  | REXTBL1 | EN1=FB1=1.2V, EXT1=0.4V               | -     | 22    | 30    | Ω     | ⑤       |
| PWM1 "High" Voltage       | VPWMH1  | No Load                               | 0.65  | -     | -     | V     | ④       |
| PWM1 "Low" Voltage        | VPWML1  | No Load                               | -     | -     | 0.20  | V     | ④       |

Unless otherwise stated, VDD=EN1=PWM1=3.0V, EN2=PWM2=GND, EXT2=OPEN, FB2=OPEN, VIN=1.8V

Output 2 Characteristics

Inverting DC/DC Controller

Ta=25°C

| PARAMETER                  | SYMBOL  | CONDITIONS  | MIN.  | TYP.  | MAX.  | UNITS | CIRCUIT |
|----------------------------|---------|---|-------|-------|-------|-------|---------|
| FB2 Voltage                | VFB2    | VDD=3.0V  | 0.882 | 0.900 | 0.918 | V     | ②       |
| Operation Start Voltage2   | VST1-2  | IOUT2=1.0mA, RFB11=200kΩ, RFB12=75kΩ, RFB21=17.5kΩ, RFB22=10kΩ, EN1=PWM1=3.0V | -     | -     | 2.0   | V     | ①       |
| Oscillation Start Voltage2 | VST2-2  | FB2=1.2V  | -     | -     | 2.0   | V     | ②       |
| Maximum Duty Ratio2        | MAXDTY2 | Same as IDD1  | 75    | 80    | 87    | %     | ②       |
| Minimum Duty Ratio2        | MINDTY3 | Same as IDD2  | -     | -     | 0     | %     | ②       |
| PFM Duty Ratio2            | PFMDTY2 | No Load, VPWM2=0V   | 22    | 30    | 38    | %     | ⑥       |
| Efficiency2 (*2)           | EFFI2   | IOUT2= -150mA, Pch MOSFET: XP162A12A6P  | -     | 76    | -     | %     | ⑥       |
| EXT2 "High" ON Resistance  | REXTBH2 | EN2=FB2= 0V, EXT2=VDD-0.4V  | -     | 28    | 47    | Ω     | ⑤       |
| EXT2 "Low" ON Resistance   | REXTBL2 | FB2=3.0V, EXT2=0.4V   | -     | 22    | 30    | Ω     | ⑤       |
| PWM2 "High" Voltage        | VPWMH2  | No Load   | 0.65  | -     | -     | V     | ⑥       |
| PWM2 "Low" Voltage         | VPWML2  | No Load   | -     | -     | 0.20  | V     | ⑥       |

Unless otherwise stated, VDD=EN2=PWM2=3.0V, PWM1=EN1=GND, EXT1=OPEN, FB1=OPEN, VIN=3.0V

NOTE: \*1: Please be careful not to exceed the breakdown voltage level of the peripheral parts.

\*2:  $EFFI1, 2 = \left\{ \frac{(\text{output voltage}) \times (\text{output current})}{(\text{input voltage}) \times (\text{input current})} \right\} \times 100$

## ELECTRICAL CHARACTERISTICS (Continued)

XC9505B093A

Common Characteristics

Ta=25°C

| PARAMETER                | SYMBOL  | CONDITIONS                     | MIN. | TYP. | MAX.  | UNITS | CIRCUIT |
|--------------------------|---------|--------------------------------|------|------|-------|-------|---------|
| Supply Voltage           | VDD     |                                | 2.0  | -    | 10.0  | V     | -       |
| Output Voltage Range(*1) | VOUTSET | VDD ≥ 2.0V, IOUT1, 2=1mA       | 0.9  | -    | VIN   | V     | ①       |
|                          |         |                                | -    | -    | 0.0   |       |         |
| Supply Current 1         | IDD1    | FB=0V, FB2=1.2V                | -    | 100  | 190   | μA    | ②       |
| Supply Current 1-1       | IDD1-1  | EN1=3.0V, EN2=0, FB1=0V        | -    | 60   | 120   | μA    | ②       |
| Supply Current 1-2       | IDD1-2  | EN2=3.0V, EN1=0, FB2=1.2V      | -    | 80   | 150   | μA    | ②       |
| Supply Current 1-3       | IDD1-3  | FB1=0V, FB2=0V                 | -    | 80   | 140   | μA    | ②       |
| Supply Current 1-4       | IDD1-4  | FB1=1.2V, FB2=1.2V             | -    | 100  | 180   | μA    | ②       |
| Supply Current 2         | IDD2    | FB1=1.2V, FB2=0V               | -    | 80   | 150   | μA    | ②       |
| Stand-by Current         | ISTB    | Same as IDD1, EN1=EN2=0V       | -    | 1.0  | 3.0   | μA    | ②       |
| Oscillation Frequency    | fosc    | Same as IDD1                   | 255  | 300  | 345   | kHz   | ②       |
| EN1, 2 "High" Voltage    | VENH    | FB1=0V, FB2=3.0V               | 0.65 | -    | -     | V     | ②       |
| EN1, 2 "Low" Voltage     | VENL    | FB1=0V, FB2=3.0V               | -    | -    | 0.20  | V     | ②       |
| EN1, 2 "High" Current    | IENH    | FB1=3.0V, FB2=0V               | -    | -    | 0.50  | μA    | ②       |
| EN1, 2 "Low" Current     | IENL    | EN1, 2=0V, FB1=3.0V, FB2=0V    | -    | -    | -0.50 | μA    | ②       |
| PWM1, 2 "High" Current   | IPWMH   | FB1=3.0V, FB2=0V, PWM1, 2=3.0V | -    | -    | 0.50  | μA    | ②       |
| PWM1, 2 "Low" Current    | IPWML   | FB1=3.0V, FB2=0V, PWM1, 2=0V   | -    | -    | -0.50 | μA    | ②       |
| FB1, 2 "High" Current    | IFBH    | FB1=3.0V, FB2=0.8V             | -    | -    | 0.50  | μA    | ②       |
| FB1, 2 "Low" Current     | VFBL    | FB1=1.0V, FB2=0V               | -    | -    | -0.50 | μA    | ②       |

Unless otherwise stated, VDD=3.0V, PWM1, 2=3.0V, EN1, 2 = 3.0V

Output 1 Characteristics

Step-Down Controller

Ta=25°C

| PARAMETER                 | SYMBOL  | CONDITIONS                            | MIN.  | TYP.  | MAX.  | UNITS | CIRCUIT |
|---------------------------|---------|---------------------------------------|-------|-------|-------|-------|---------|
| FB1 Voltage               | VFB1    | VDD=3.0V, VIN=1.5V, IOUT1=10mA        | 0.882 | 0.900 | 0.918 | V     | ③       |
| Minimum Operating Voltage | VINmin1 |                                       | -     | -     | 2.0   | V     | ①       |
| Maximum Duty Ratio1       | MINDTY1 | Same as IDD1                          | -     | -     | 100   | %     | ②       |
| Minimum Duty Ratio1       | MAXDTY2 | Same as IDD2                          | -     | -     | -     | %     | ②       |
| PFM Duty Ratio1           | PFMDTY1 | No Load, VPWM1=0V                     | 22    | 30    | 38    | %     | ④       |
| Efficiency1 (*2)          | EFFI1   | IOUT1= 250mA, Pch MOSFET: XP162A12A6P | -     | 92    | -     | %     | ④       |
| Soft-Start Time1          | tss1    | VOUT1 × 0.95V, EN1=0V → 0.65V         | 5.0   | 10.0  | 20.0  | ms    | ④       |
| EXT1 "High" ON Resistance | REXTBH1 | FB1=0V, EXT1=VDD -0.4V                | -     | 28    | 47    | Ω     | ⑤       |
| EXT1 "Low" ON Resistance  | REXTBL1 | EN1=FB1=1.2V, EXT1=0.4V               | -     | 22    | 30    | Ω     | ⑤       |
| PWM1 "High" Voltage       | VPWMH1  | No Load                               | 0.65  | -     | -     | V     | ④       |
| PWM1 "Low" Voltage        | VPWML1  | No Load                               | -     | -     | 0.20  | V     | ④       |

Unless otherwise stated, VDD=EN1=PWM1=3.0V, EN2=PWM2=GND, EXT2=OPEN, FB2=OPEN, VIN=1.8V

Output 2 Characteristics

Inverting DC/DC Controller

Ta=25°C

| PARAMETER                  | SYMBOL  | CONDITIONS  | MIN.  | TYP.  | MAX.  | UNITS | CIRCUIT |
|----------------------------|---------|---|-------|-------|-------|-------|---------|
| FB2 Voltage                | VFB2    | VDD=3.0V  | 0.882 | 0.900 | 0.918 | V     | ②       |
| Operation Start Voltage2   | VST1-2  | IOUT2=1.0mA, RFB11=200kΩ, RFB12=75kΩ, RFB21=17.5kΩ, RFB22=10kΩ, EN1=PWM1=3.0V | -     | -     | 2.0   | V     | ①       |
| Oscillation Start Voltage2 | VST2-2  | FB2=1.2V  | -     | -     | 2.0   | V     | ②       |
| Maximum Duty Ratio2        | MAXDTY2 | Same as IDD1  | 75    | 80    | 87    | %     | ②       |
| Minimum Duty Ratio2        | MINDTY3 | Same as IDD2  | -     | -     | 0     | %     | ②       |
| PFM Duty Ratio2            | PFMDTY2 | No Load, VPWM2=0V   | 22    | 30    | 38    | %     | ⑥       |
| Efficiency2 (*2)           | EFFI2   | IOUT2= -150mA, Pch MOSFET: XP162A12A6P  | -     | 75    | -     | %     | ⑥       |
| EXT2 "High" ON Resistance  | REXTBH2 | EN2=FB2= 0V, EXT2=VDD-0.4V  | -     | 28    | 47    | Ω     | ⑤       |
| EXT2 "Low" ON Resistance   | REXTBL2 | FB2=3.0V, EXT2=0.4V   | -     | 22    | 30    | Ω     | ⑤       |
| PWM2 "High" Voltage        | VPWMH2  | No Load   | 0.65  | -     | -     | V     | ⑥       |
| PWM2 "Low" Voltage         | VPWML2  | No Load   | -     | -     | 0.20  | V     | ⑥       |

Unless otherwise stated, VDD=EN2=PWM2=3.0V, PWM1=EN1=GND, EXT1=OPEN, FB1=OPEN, VIN=3.0V

NOTE: \*1: Please be careful not to exceed the breakdown voltage level of the peripheral parts.

\*2: EFFI1, 2={ [ (output voltage) x (output current) ] / [ (input voltage) x (input current) ] } x 100

## ELECTRICAL CHARACTERISTICS (Continued)

XC9505B095A

Common Characteristics

Ta=25°C

| PARAMETER                | SYMBOL  | CONDITIONS                     | MIN.  | TYP. | MAX.  | UNITS | CIRCUIT |   |
|--------------------------|---------|--------------------------------|-------|------|-------|-------|---------|---|
| Supply Voltage           | VDD     |                                | 2.0   | -    | 10.0  | V     | -       |   |
| Output Voltage Range(*1) | VOUTSET | VDD ≥ 2.0V, IOUT1, 2=1mA       | VOUT1 | 0.9  | -     | VIN   | V       | ① |
|                          |         |                                | VOUT2 | -    | -     | 0.0   |         |   |
| Supply Current 1         | IDD1    | FB=0V, FB2=1.2V                | -     | 130  | 250   | μA    | ②       |   |
| Supply Current 1-1       | IDD1-1  | EN1=3.0V, EN2=0, FB1=0V        | -     | 80   | 150   | μA    | ②       |   |
| Supply Current 1-2       | IDD1-2  | EN2=3.0V, EN1=0, FB2=1.2V      | -     | 110  | 220   | μA    | ②       |   |
| Supply Current 1-3       | IDD1-3  | FB1=0V, FB2=0V                 | -     | 100  | 170   | μA    | ②       |   |
| Supply Current 1-4       | IDD1-4  | FB1=1.2V, FB2=1.2V             | -     | 140  | 230   | μA    | ②       |   |
| Supply Current 2         | IDD2    | FB1=1.2V, FB2=0V               | -     | 100  | 190   | μA    | ②       |   |
| Stand-by Current         | ISTB    | Same as IDD1, EN1=EN2=0V       | -     | 1.0  | 3.0   | μA    | ②       |   |
| Oscillation Frequency    | fOSC    | Same as IDD1                   | 425   | 500  | 575   | kHz   | ②       |   |
| EN1, 2 "High" Voltage    | VENH    | FB1=0V, FB2=3.0V               | 0.65  | -    | -     | V     | ②       |   |
| EN1, 2 "Low" Voltage     | VENL    | FB1=0V, FB2=3.0V               | -     | -    | 0.20  | V     | ②       |   |
| EN1, 2 "High" Current    | IENH    | FB1=3.0V, FB2=0V               | -     | -    | 0.50  | μA    | ②       |   |
| EN1, 2 "Low" Current     | IENL    | EN1, 2=0V, FB1=3.0V, FB2=0V    | -     | -    | -0.50 | μA    | ②       |   |
| PWM1, 2 "High" Current   | IPWMH   | FB1=3.0V, FB2=0V, PWM1, 2=3.0V | -     | -    | 0.50  | μA    | ②       |   |
| PWM1, 2 "Low" Current    | IPWML   | FB1=3.0V, FB2=0V, PWM1, 2=0V   | -     | -    | -0.50 | μA    | ②       |   |
| FB1, 2 "High" Current    | IFBH    | FB1=3.0V, FB2=0.8V             | -     | -    | 0.50  | μA    | ②       |   |
| FB1, 2 "Low" Current     | VFBL    | FB1=1.0V, FB2=0V               | -     | -    | -0.50 | μA    | ②       |   |

Unless otherwise stated, VDD=3.0V, PWM1, 2=3.0V, EN1, 2 = 3.0V

Output 1 Characteristics

Step-Down Controller

Ta=25°C

| PARAMETER                 | SYMBOL  | CONDITIONS                             | MIN.  | TYP.  | MAX.  | UNITS | CIRCUIT |
|---------------------------|---------|--|-------|-------|-------|-------|---------|
| FB1 Voltage               | VFB1    | VDD=3.0V, VIN=1.5V, IOUT1=10mA         | 0.882 | 0.900 | 0.918 | V     | ③       |
| Minimum Operating Voltage | VINmin1 |  | -     | -     | 2.0   | V     | ①       |
| Maximum Duty Ratio1       | MINDTY1 | Same as IDD1                           | -     | -     | 100   | %     | ②       |
| Minimum Duty Ratio1       | MAXDTY2 | Same as IDD2                           | -     | -     | 0     | %     | ②       |
| PFM Duty Ratio1           | PFMDTY1 | No Load, VPWM1=0V                      | 22    | 30    | 38    | %     | ④       |
| Efficiency1 (*2)          | EFFI1   | IOUT1= 250mA, P-ch MOSFET: XP162A12A6P | -     | 91    | -     | %     | ④       |
| Soft-Start Time1          | tSS1    | VOUT1 × 0.95V, EN1=0V → 0.65V          | 5.0   | 10.0  | 20.0  | ms    | ④       |
| EXT1 "High" ON Resistance | REXTBH1 | FB1=0V, EXT1=VDD -0.4V                 | -     | 28    | 47    | Ω     | ⑤       |
| EXT1 "Low" ON Resistance  | REXTBL1 | EN1=FB1=1.2V, EXT1=0.4V                | -     | 22    | 30    | Ω     | ⑤       |
| PWM1 "High" Voltage       | VPWMH1  | No Load                                | 0.65  | -     | -     | V     | ④       |
| PWM1 "Low" Voltage        | VPWML1  | No Load                                | -     | -     | 0.20  | V     | ④       |

Unless otherwise stated, VDD=EN1=PWM1=3.0V, EN2=PWM2=GND, EXT2=OPEN, FB2=OPEN, VIN=1.8V

Output 2 Characteristics

Inverting DC/DC Controller

Ta=25°C

| PARAMETER                  | SYMBOL  | CONDITIONS  | MIN.  | TYP.  | MAX.  | UNITS | CIRCUIT |
|----------------------------|---------|---|-------|-------|-------|-------|---------|
| FB2 Voltage                | VFB2    | VDD=3.0V  | 0.882 | 0.900 | 0.918 | V     | ②       |
| Operation Start Voltage2   | VST1-2  | IOUT2=1.0mA, RFB11=200kΩ, RFB12=75kΩ, RFB21=17.5kΩ, RFB22=10kΩ, EN1=PWM1=3.0V | -     | -     | 2.0   | V     | ①       |
| Oscillation Start Voltage2 | VST2-2  | FB2=1.2V  | -     | -     | 2.0   | V     | ②       |
| Maximum Duty Ratio2        | MAXDTY2 | Same as IDD1  | 75    | 80    | 87    | %     | ②       |
| Minimum Duty Ratio2        | MINDTY3 | Same as IDD2  | -     | -     | 0     | %     | ②       |
| PFM Duty Ratio2            | PFMDTY2 | No Load, VPWM2=0V   | 22    | 30    | 38    | %     | ⑥       |
| Efficiency2 (*2)           | EFFI2   | IOUT2= -150mA, P-ch MOSFET: XP162A12A6P                                       | -     | 71    | -     | %     | ⑥       |
| EXT2 "High" ON Resistance  | REXTBH2 | EN2=FB2= 0V, EXT2=VDD-0.4V  | -     | 28    | 47    | Ω     | ⑤       |
| EXT2 "Low" ON Resistance   | REXTBL2 | FB2=3.0V, EXT2=0.4V   | -     | 22    | 30    | Ω     | ⑤       |
| PWM2 "High" Voltage        | VPWMH2  | No Load   | 0.65  | -     | -     | V     | ⑥       |
| PWM2 "Low" Voltage         | VPWML2  | No Load   | -     | -     | 0.20  | V     | ⑥       |

Unless otherwise stated, VDD=EN2=PWM2=3.0V, PWM1=EN1=GND, EXT1=OPEN, FB1=OPEN, VIN=3.0V

NOTE: \*1: Please be careful not to exceed the breakdown voltage level of the peripheral parts.

\*2: EFFI1, 2= { [ (output voltage) x (output current) ] / [ (input voltage) x (input current) ] } x 100

## ■ OPERATIONAL DESCRIPTION

The XC9505 series are dual DC/DC (step-down + inverting) converter controller ICs with built-in high speed, low ON resistance buffers.

### <Error Amp. 1>

Error amplifier 1 is designed to monitor the output voltage and it compares the feedback voltage 1 (FB1) with the reference voltage Vref1. In response to feedback of a voltage lower than the reference voltage Vref1, the output voltage of the error amp. decreases.

### <Error Amp. 2>

Error amplifier 2 is designed to monitor the output voltage and it compares the feedback voltage 2 (FB2) with the reference voltage Vref 2. In response to feedback of a voltage lower than the reference voltage Vref2, the output voltage of the error amp. decreases.

### <OSC Generator>

This circuit generates the internal reference clock.

### <Ramp Wave Generator 1, 2>

The ramp wave generator generates a saw-tooth waveform based on outputs from the OSC generator.

### <PWM Comparator 1, 2>

The PWM comparator compares outputs from the error amp. and saw-tooth waveform. When the voltage from the error amp's output is low, the external switch will be set to ON.

### <PWM/PFM Controller 1, 2>

This circuit generates PFM pulses.

Control can be switched between PWM control and PWM/PFM automatic switching control using external signals.

The PFM/PWM automatic switching mode is selected when the voltage of the PWM1 (2) pin is less than 0.2V, and the control switches between PWM and PFM automatically depending on the load. As the PFM circuit generates pulses based on outputs from the PWM Comparator, shifting between modes occurs smoothly. PWM control mode is selected when the voltage of the PWM1 (2) pin is more than 0.65V. Noise is easily reduced with PWM control since the switching frequency is fixed. Control suited to the application can easily be selected which is useful in audio applications, for example, where traditionally, efficiencies have been sacrificed during stand-by as a result of using PWM control (due to the noise problems associated with the PFM mode in stand-by).

### <Vref 1 with Soft Start 1>

The reference voltage, Vref1 (FB1 pin voltage)=0.9V, is adjusted and fixed by laser trimming (for output voltage settings, please refer to the functional settings on next page.). To protect against inrush current, when the power is switched on, and also to protect against voltage overshoot, soft-start time is set internally to 10ms. It should be noted, however, that this circuit does not protect the load capacitor (CL) from inrush current. With the Vref voltage limited, and depending upon the input to error amp 1, the operation maintains a balance between the two inputs of error amps and controls the EXT pin's ON time so that it doesn't increase more than is necessary.

### <Vref 2>

The reference voltage, Vref2 (FB2 pin voltage)=0.9V, is adjusted and fixed by laser trimming.

### <Enable Function 1,2>

This function controls the operation and shutdown of the IC. When the voltage of the EN1 or EN2 pins is 0.2V or less, the mode will be disable, the channel's operations will stop and the EXT1 and the EXT2 pin will be kept at a high level (the external P-ch MOSFET will be OFF). When both EN1 and EN2 are in a state of chip disable, current consumption will be no more than  $3.0\mu\text{A}$ . When the EN1 or EN2 pin's voltage is 0.65V or more, the mode will be enable and operations will recommence. With channel one (output 1) soft-start, 95% of the set output voltage will be reached within 10ms (TYP.) from the moment of enable.

## OPERATING EXPLANATION

< Output Voltage Setting, Ch.1 (Step-up DC/DC Converter Controller) >

Output voltage can be set by adding external split resistors. Output voltage is determined by the following equation, based on the values of RFB11 and RFB12. The sum of RFB11 and RFB12 should normally be 1MΩ or less.

$$V_{OUT1} = 0.9 \times (R_{FB11} + R_{FB12}) / R_{FB12}$$

The speed-up capacitor for phase compensation's (CFB1) value should be adjusted using the formula  $f_{zfb} = 1 / (2 \times \pi \times C_{FB1} \times R_{FB11})$  so that it equals 12kHz. Depending on the application, the inductance value L, and the load capacity value C<sub>L</sub>, adjustments to this value are suggested so that the value is somewhere between 1kHz to 50kHz.

[Calculation Example]

When RFB11=200kΩ and RFB12=75kΩ :  $V_{OUT1} = 0.9 \times (200k + 75k) / 75k = 3.3V$ .

### [Typical Example]

| VOUT (V) | RFB11 (kΩ) | RFB12 (kΩ) | CFB1 (pF) | VOUT (V) | RFB11 (kΩ) | RFB12 (kΩ) | CFB1 (pF) |
|----------|------------|------------|-----------|----------|------------|------------|-----------|
| 1.0      | 30         | 270        | 430       | 2.5      | 390        | 220        | 33        |
| 1.5      | 220        | 330        | 62        | 2.7      | 360        | 180        | 33        |
| 1.8      | 220        | 220        | 62        | 3.0      | 560        | 240        | 24        |
| 2.0      | 330        | 270        | 39        | 3.3      | 200        | 75         | 62        |
| 2.2      | 390        | 270        | 33        | 5.0      | 82         | 18         | 160       |

< Output Voltage Setting, Ch.2 (Inverting DC/DC Converter) >

Output voltage can be set by adding reference voltage and split resistors externally. Output voltage is determined using the following equation and is based on the values of RFB21 and RFB22. The sum of RFB21 and RFB22 should normally be 500kΩ or less. The equation uses Ch 1's (VOUT1) output voltage calculation method for the reference voltage.

$$V_{OUT2} = (0.9 - V_{OUT1}) \times (R_{FB21} / R_{FB22}) + 0.9V$$

[Calculation Example]

When RFB21=17.5kΩ RFB22=10kΩ, VOUT1=3.3V, VOUT2= - 3.3V

The value of speed-up capacitor for phase compensation CFB21:

**[Conditions: Heavy load (when coil current is continuous.)]**

$$f_{zfb2} = 1/2 \times \pi \times C_{FB21} \times R_{FB21} = 10kHz$$

Depending on the application, the inductance value L, and the load capacity value C<sub>L</sub>, adjustments to this value are suggested so that the value is somewhere between 0.1kHz to 50kHz.

**[Conditions: Light load (when coil current is discontinuous.)]**

Less than CFB21=0.1μF

Depending on the application, the inductance value L, and the load capacity value C<sub>L</sub>, adjustments to this value are suggested.

> Example Circuit 1: Using voltage of Ch 1 (Step-Down)

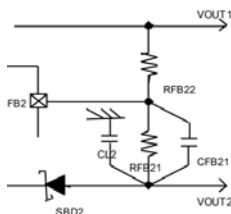

Channel 1 (Step-Down) circuits should be enabled by setting EN1 to High level so that a stable voltage is provided. Inrush current to the inverter when the supply voltage V<sub>DD</sub> of the IC is 2.0 V or higher can be controlled by setting EN 1 and EN 2 to enable ("H" level) simultaneously.

> Example Circuit 2: Using a positive regulator

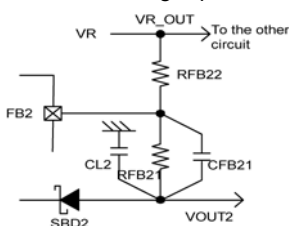

A stable positive voltage produced by a positive-voltage regulator or by other means is usable.

$$V_{OUT2} = (0.9 - V_{ROUT}) \times (R_{FB21} / R_{FB22}) + 0.9V$$



## EXTERNAL COMPONENTS

Conditions: Light load (when coil current is discontinuous)

### Channel One (Step-Down DC/DC Converter Controller)

**Tr 1 : \* MOSFET**

XP152A12C0 (P-ch Power MOSFET, TOREX)  
Note: V<sub>GS</sub> Breakdown Voltage of this Tr. is 12V so please be careful with the power supply voltage.

SD 1 : CRS02 (Schottky, TOSHIBA)  
L1 : 10 μH (CDRH4D18C, SUMIDA, D412F, TOKO, f<sub>OSC</sub> = 500kHz)  
15 μH (CDRH4D18C, SUMIDA, D412F, TOKO, f<sub>OSC</sub> = 300kHz)  
22 μH (CDRH4D18C, SUMIDA, D412F, TOKO, f<sub>OSC</sub> = 180kHz)

Please set so that the coil current is discontinuous.

CL1 : 10V, 4.7 μF (Ceramic)

**\*PNP Tr**

2SA1213 (TOSHIBA)

RB1 : 500Ω Adjust in accordance with load & Tr.'s h<sub>FE</sub>

$$RB1 \leq (VIN - 0.7) \times (h_{FE} / I_C - R_{EXTBL})$$

CB1 : 2200pF (Ceramic)

$$CB1 \leq (2\pi \times RB1 \times f_{OSC} \times 0.7)$$

### Channel Two (Inverter DC/DC Controller)

**Tr 2 : \* MOSFET**

XP152A12C0 (P-ch Power MOSFET, TOREX)  
Note: V<sub>GS</sub> Breakdown Voltage of this Tr. is 12V so please be careful with the power supply voltage.

SD 2 : CRS02 (Schottky, TOSHIBA)  
L2 : 10 μH (CDRH4D18C, SUMIDA, D412F, TOKO, f<sub>OSC</sub> = 500kHz)  
15 μH (CDRH4D18C, SUMIDA, D412F, TOKO, f<sub>OSC</sub> = 300kHz)  
22 μH (CDRH4D18C, SUMIDA, D412F, TOKO, f<sub>OSC</sub> = 180kHz)

Please set so that the coil current is discontinuous.

CL2 : 10V, 4.7 μF (Ceramic)

**\*PNP Tr**

2SA1213 (TOSHIBA)

RB2 : 500Ω Adjust in accordance with load & Tr.'s h<sub>FE</sub>

$$RB2 \leq (VIN - 0.7) \times (h_{FE} / I_C - R_{EXTBL})$$

CB2 : 2200pF (Ceramic)

$$CB2 \leq (2\pi \times RB2 \times f_{OSC} \times 0.7)$$

Conditions: Heavy load (when coil current is continuous)

### Channel One (Step-Down DC/DC Converter Controller)

**Tr 1 : \* MOSFET**

XP162A12A6P (P-ch Power MOSFET, TOREX)  
Note: V<sub>GS</sub> Breakdown Voltage of this Tr. is 12V so please be careful with the power supply voltage.

SD 1 : MA2Q737 (Schottky, MATSUSHITA)  
L1 : CMS02 (Schottky, TOSHIBA) (CDRH5D28, SUMIDA, f<sub>OSC</sub> = 500kHz)  
10 μH (CDRH5D28, SUMIDA, f<sub>OSC</sub> = 300kHz)  
22 μH (CDRH5D28, SUMIDA, f<sub>OSC</sub> = 180kHz)  
47 μH (CDRH5D28, SUMIDA, f<sub>OSC</sub> = 180kHz)

CL1 : 16V, 47 μF (Tantalum)  
CL = (CL standard value) × (I<sub>OUT1</sub> (mA) / 500mA) × V<sub>OUT1</sub> / V<sub>IN</sub>

**\*PNP Tr**

2SA1213 (TOSHIBA)

RB1 : 500Ω Adjust in accordance with load & Tr.'s h<sub>FE</sub>

$$RB1 \leq (VIN - 0.7) \times (h_{FE} / I_C - R_{EXTBL})$$

CB1 : 2200pF (Ceramic)

$$CB1 \leq (2\pi \times RB1 \times f_{OSC} \times 0.7)$$

### Channel Two (Inverter DC/DC Controller)

**Tr 2 : \* MOSFET**

XP162A12A6P (P-ch Power MOSFET, TOREX)  
Note: V<sub>GS</sub> Breakdown Voltage of this Tr. is 12V so please be careful with the power supply voltage.

SD 2 : MA2Q737 (Schottky, MATSUSHITA)  
L2 : CRS02, CMS02 (Schottky, TOSHIBA) (CDRH5D28, SUMIDA, f<sub>OSC</sub> = 500kHz)  
10 μH (CDRH5D28, SUMIDA, f<sub>OSC</sub> = 300kHz)  
15 μH (CDRH5D28, SUMIDA, f<sub>OSC</sub> = 180kHz)  
22 μH (CDRH5D28, SUMIDA, f<sub>OSC</sub> = 180kHz)

CL2 : 16V, 47 μF (Tantalum)  
CL = (CL standard value) × (I<sub>OUT2</sub> (mA) / 150mA) × V<sub>OUT2</sub> / V<sub>IN</sub>

**\*PNP Tr**

2SA1213 (TOSHIBA)

RB2 : 500Ω Adjust in accordance with load & Tr.'s h<sub>FE</sub>

$$RB2 \leq (VIN - 0.7) \times (h_{FE} / I_C - R_{EXTBL})$$

CB2 : 2200pF (Ceramic)

$$CB2 \leq (2\pi \times RB2 \times f_{OSC} \times 0.7)$$

## NOTES ON USE

### Application Hint

#### 1. Channel 2 (Inverting) Soft start circuit

Channel 2 (inverting) is subject to the overshoot of output voltage 2 ( $V_{OUT2}$ ) at start-up. It is possible to control the overshoot of output voltage 2 ( $V_{OUT2}$ ), as shown by circuit example 1 in "Output Voltage Settings for Channel 2" in "Function Settings." In this circuit configuration, EN 1 and EN 2 are enabled simultaneously. This lets output voltage 1 ( $V_{OUT1}$ ) of channel 1 increase gently as soft start, thereby controlling the overshoot.

> Example of Typical application circuit: Improved Soft start

This example is effective when EN 1 and EN 2 are enabled with different timings under light load condition (the coil current being discontinuous).

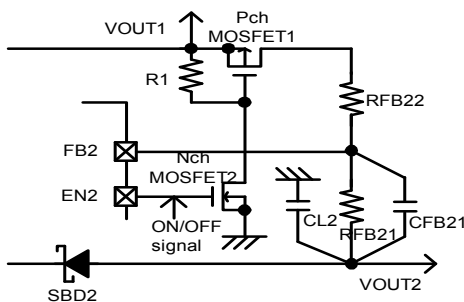

Time to make soft start time  $t_{SS2}$  is calculated by the equation below.

$$Time_{SS2} = -R_{FB21} \times C_{CFB21} / \ln \left[ 1 - \frac{(0.9 - V_{OUT2}) \times R_{FB22}}{(V_{OUT1} - 0.9) \times R_{FB21}} \right]$$

Example)

When  $V_{OUT1} = 3.3V$  and  $V_{OUT2} = -7.5V$ ,

$R_{FB21} = 350k\Omega$ ,  $R_{FB22} = 100k\Omega$  by the equation below.

$$V_{OUT2} = (0.9 - V_{OUT1}) \times (R_{FB21} / R_{FB22}) + 0.9$$

When the light load,  $C_{CFB21} = 0.1 \mu F$  or lower value can be used.

Therefore, when  $C_{CFB21} = 0.027 \mu F$ ,

$t_{SS2} = 5.0ms$  and  $V_{OUT2} = 95\%$  of setting value

#### 2. Channel 2 (Inverting)

#### Withstand voltage of transistor

The voltage applied between the drain and source is the sum of  $V_{IN}$  and  $V_{OUT2}$ .

Select a transistor with an absolute  $V_{DSS}$  rating that is suitable for your operating conditions.

Example: The voltage applied across  $V_{DS}$  of a transistor will be 20.0V if  $V_{IN} = 5.0V$  and  $V_{OUT2} = -15.0V$ .

Under this condition, a transistor with  $V_{DSS}$  higher than 20.0V should be selected. (Use a transistor with  $V_{DSS}$  that is 1.5 times the applied voltage or more, as a standard.)



## EXTERNAL COMPONENTS OF TEST CIRCUITS

### Circuit ①

- L1, L2: 22  $\mu$  H (CDRH5D28, SUMIDA) : XC9505B092A  
 15  $\mu$  H (CDRH5D28, SUMIDA) : XC9505B093A  
 10  $\mu$  H (CDRH5D28, SUMIDA) : XC9505B095A
- SD1, SD2 : CRS02 (Schottky, TOSHIBA)  
 EC10QS06 (Schottky, NIHON INTER)
- CL1, CL2 : 16MCE476MD2 (Tantalum, NIHON CHEMICON)  
 35MCE335MB x 3 (Tantalum, NIHON CHEMICON)
- CIN : 16MCE476MD2
- PNP Tr 1 : 2SA1213 (TOSHIBA)
- PNP Tr 2 : 2SA1213 (TOSHIBA)
- RFB : Please use by the conditions as below.  
 $R_{FB11} + R_{FB12} \leq 1M \Omega$   
 $R_{FB21} + R_{FB22} \leq 1M \Omega$   
 $R_{FB11} / R_{FB12} = (\text{Setting Output Voltage} / 0.9) - 1$   
 $V_{OUT2} = (0.9 - V_{OUT1}) / (R_{FB21} / R_{FB22}) + 0.9V$
- CFB :  $f_{zfb} = 1 / (2 \times \pi \times C_{FB1} \times R_{FB11}) = 1kHz \text{ to } 50kHz (12kHz \text{ usual})$   
 $f_{zfb} = 1 / (2 \times \pi \times C_{FB2} \times R_{FB21}) = 1kHz \text{ to } 50kHz (12kHz \text{ usual}).$

### Circuit ③

- L1 : 22  $\mu$  H (SUMIDA CDRH5D28)
- SD 1 : MA2Q737 (Schottky, MATSUSHITA)
- CL1 : 16MCE476MD2 (Tantalum, NIHONCHEMICON)
- CIN : 16MCE476MD2 (Tantalum, NIHONCHEMICON)
- Pch MOSFET : XP162A12A6P (TOREX)

### Circuit ④

- L1 : 22  $\mu$  H (CDRH5D28, SUMIDA) : XC9505B092A  
 15  $\mu$  H (CDRH5D28, SUMIDA) : XC9505B093A  
 10  $\mu$  H (CDRH5D28, SUMIDA) : XC9505B095A
- SD 1 : MA2Q737 (Schottky, MATSUSHITA)
- CL1 : 16MCE476MD2 (Tantalum, NIHONCHEMICON)
- CIN : 16MCE476MD2 (Tantalum, NIHONCHEMICON)
- Pch MOSFET : XP162A12A6P (TOREX)

### Circuit ⑥

- L2 : 22  $\mu$  H (CDRH5D28, SUMIDA) : XC9505B092A  
 15  $\mu$  H (CDRH5D28, SUMIDA) : XC9505B093A  
 10  $\mu$  H (CDRH5D28, SUMIDA) : XC9505B095A
- SD 2 : MA2Q737 (Schottky, MATSUSHITA)
- CL2 : 16MCE476MD2 (Tantalum, NIHONCHEMICON)
- CIN : 16MCE476MD2 (Tantalum, NIHONCHEMICON)
- Pch MOSFET : XP162A12A6P (TOREX)

## ■ NOTES ON USE

### 1. Checking for Intermittent Oscillation

The XC9505 series is subject to intermittent oscillation in the proximity of the maximum duty cycle if the step-down ratio is low (e.g., from 4.2 V to 3.3 V) or a heavy load is applied where the duty ratio becomes high. Check waveforms at EXT under your operating conditions. A remedy for this problem is to raise the inductance of coil L or increase the load capacitance  $C_L$ .

### 2. PWM/PFM Automatic Switching

If PWM/PFM automatic switching control is selected and the step-down ratio is high (e.g., from 10.0 V to 1.0 V), the control mode remains in PFM setting over the whole load range, since the duty ratio under continuous-duty condition is smaller than the PFM duty ratio of the XC9505 series. The output voltage's ripple voltage becomes substantially high under heavy load conditions, with the XC9505 series appearing to be producing an abnormal oscillation. If this operation becomes a concern, set pins PWM to High to set the control mode to PWM setting. For use under the above-mentioned condition, measured data of PWM/PFM automatic switching control shown on the data sheets are available up to  $I_{OUT} = 100$  mA.

### 3. Ratings

Use the XC9505 series and peripheral components within the limits of their ratings.

## TYPICAL PERFORMANCE CHARACTERISTICS

< 1 ch Step-Down DC/DC Controller >

(1) Output Voltage vs. Output Current

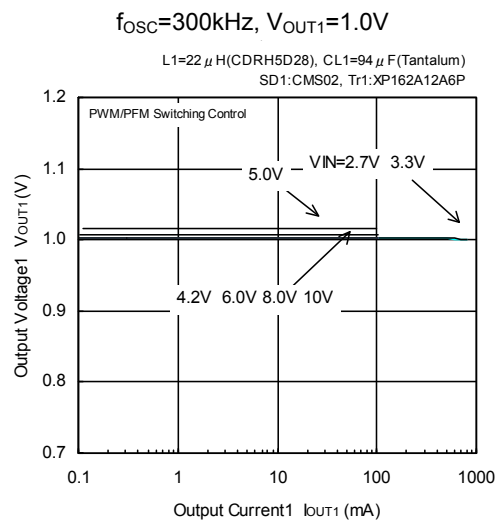
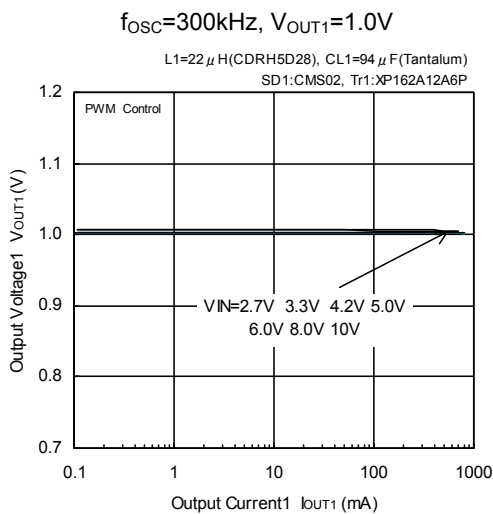
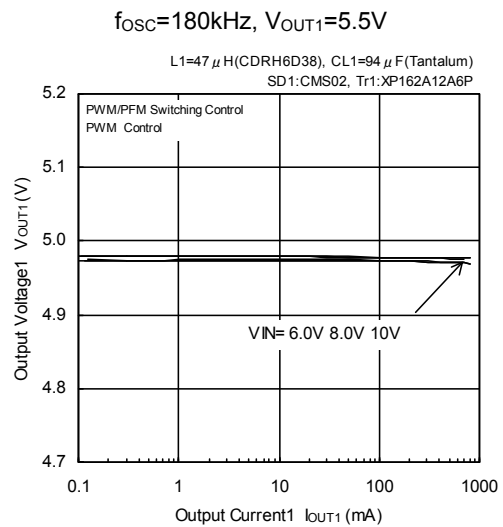
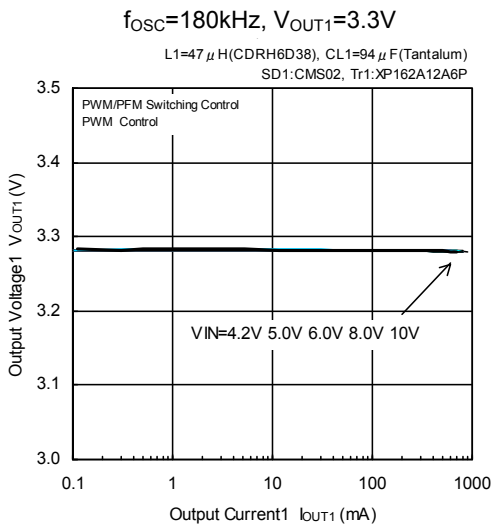
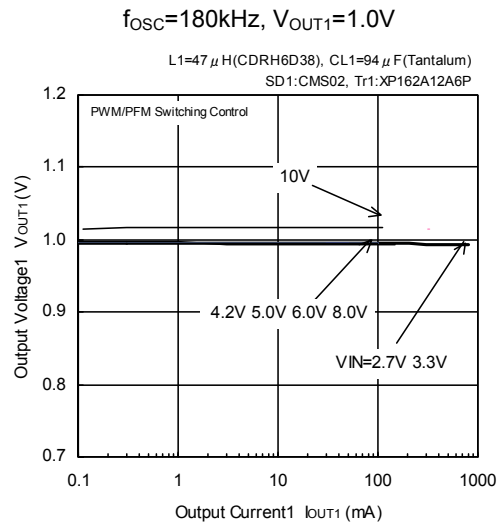
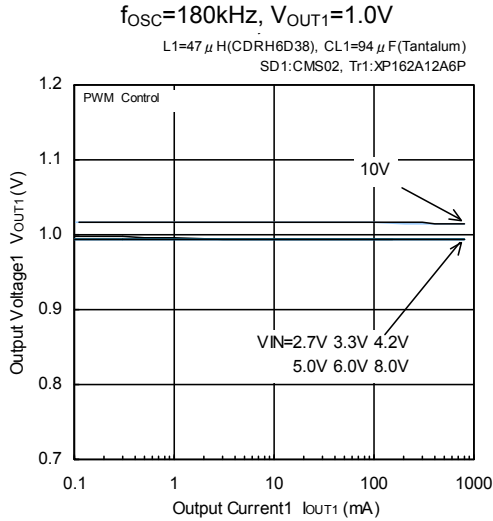

\* When setting  $V_{OUT1}=1.0V$ ,  $V_{IN}=8.0V$  or  $10.0V$ ,  
 $CL=94 \mu$  F (Tantalum) +  $100 \mu$  F (OS Capacitor)

## ■ TYPICAL PERFORMANCE CHARACTERISTICS (Continued)

< 1 ch Step-Down DC/DC Controller > (Continued)

(1) Output Voltage vs. Output Current (Continued)

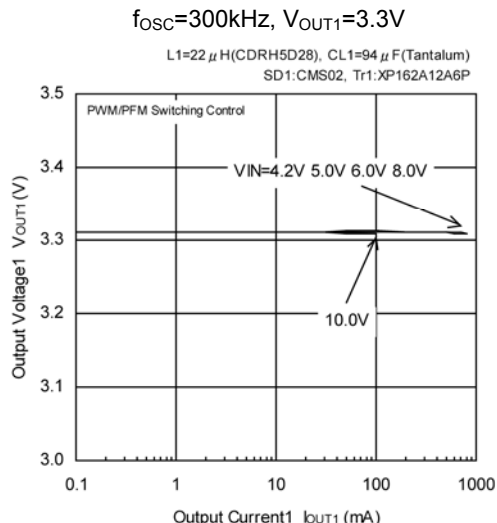
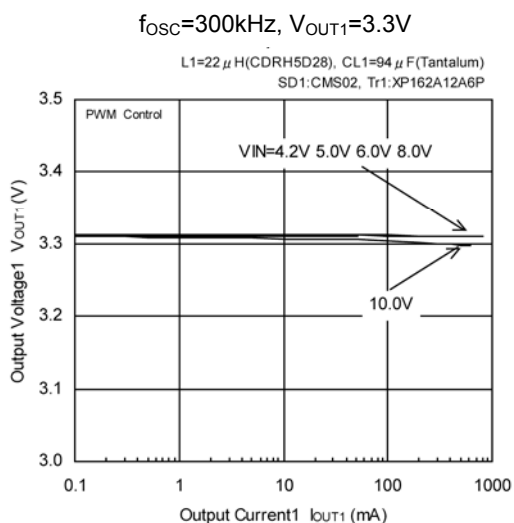
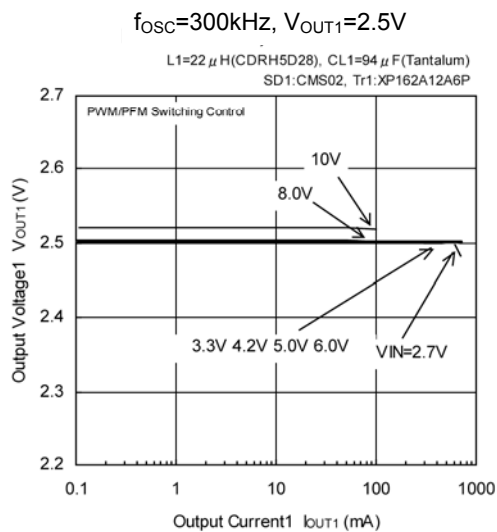
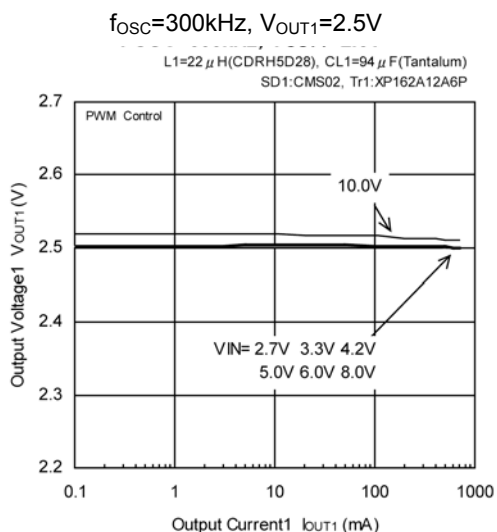
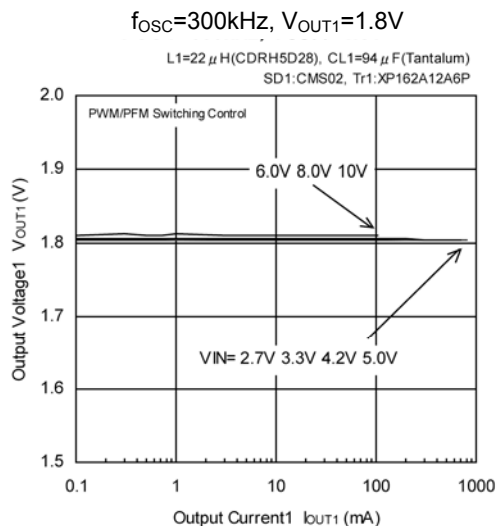
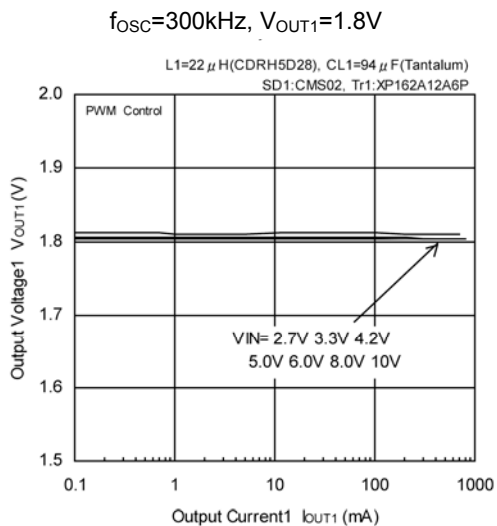

\* When setting  $V_{OUT1}=1.0V$ ,  $V_{IN}=8.0V$  or  $10.0V$   
CL=94  $\mu$ F (Tantalum) + 100  $\mu$ F (OS Capacitor)

## ■ TYPICAL PERFORMANCE CHARACTERISTICS (Continued)

< 1 ch Step-Down DC/DC Controller > (Continued)

(1) Output Voltage vs. Output Current (Continued)

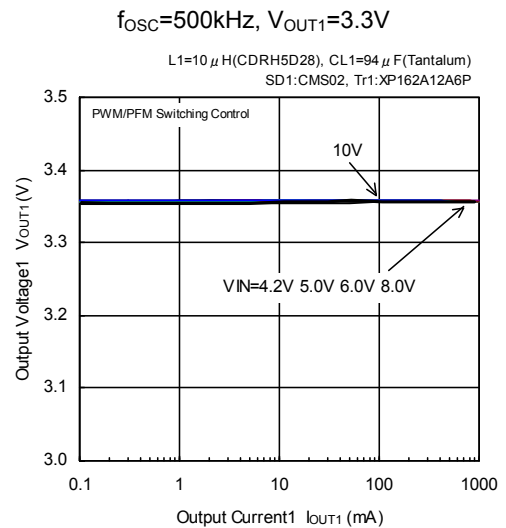
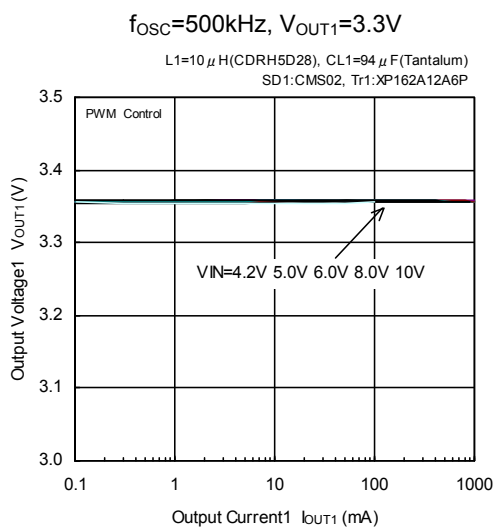
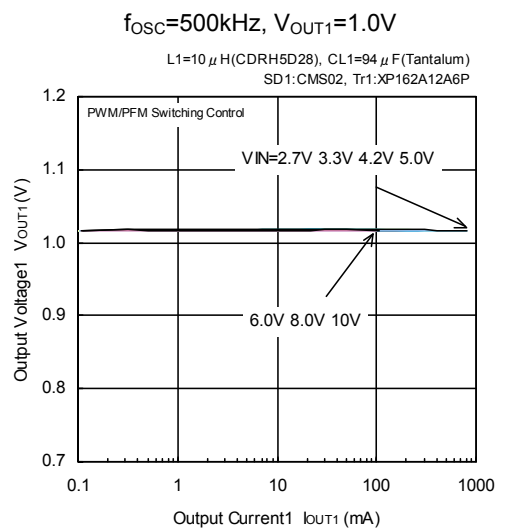
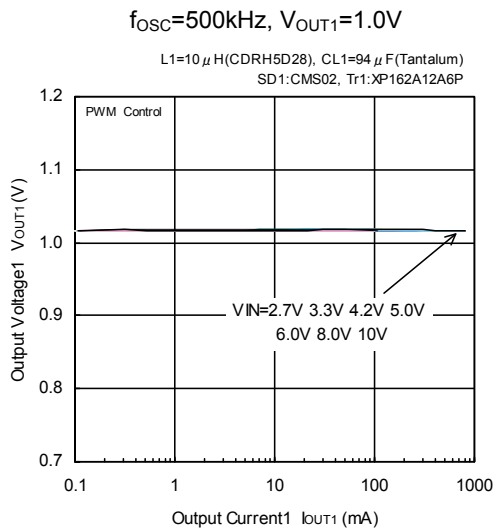
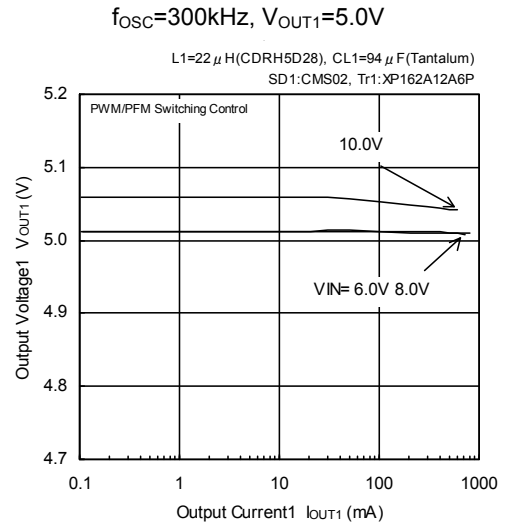
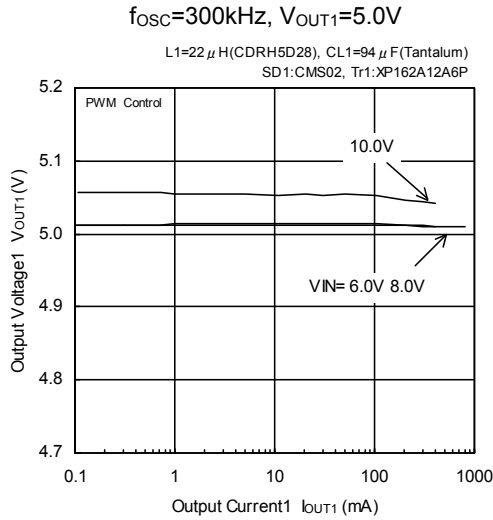

\* When setting  $V_{OUT1}=1.0V$ ,  $V_{IN}=8.0V$  or  $10.0V$ ,  
 $CL=94\mu F$  (Tantalum) +  $100\mu F$  (OS Capacitor)



## ■ TYPICAL PERFORMANCE CHARACTERISTICS (Continued)

< 1 ch Step-Down DC/DC Controller > (Continued)

(1) Output Voltage vs. Output Current (Continued)

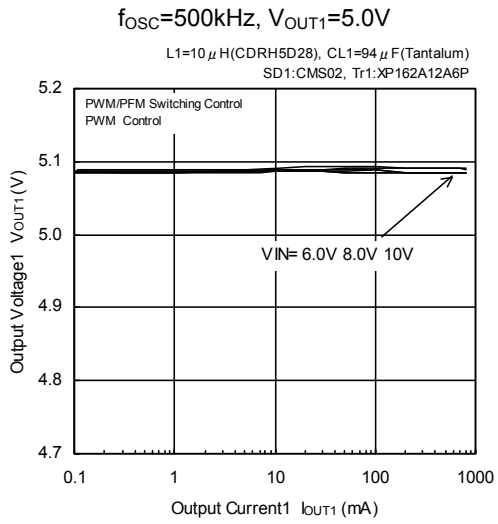

\* When setting  $V_{OUT1}=1.0V$ ,  $V_{IN}=8.0V$  or  $10.0V$ ,  
 $CL=94\mu F$  (Tantalum) +  $100\mu F$  (OS Capacitor)

## TYPICAL PERFORMANCE CHARACTERISTICS (Continued)

< 1 ch Step-Down DC/DC Controller > (Continued)

(2) Efficiency vs. Output Current

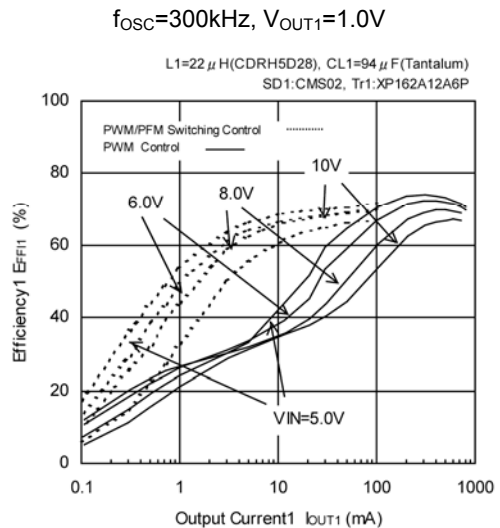
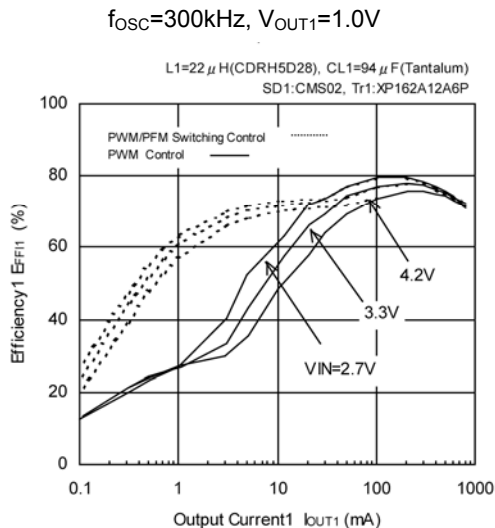
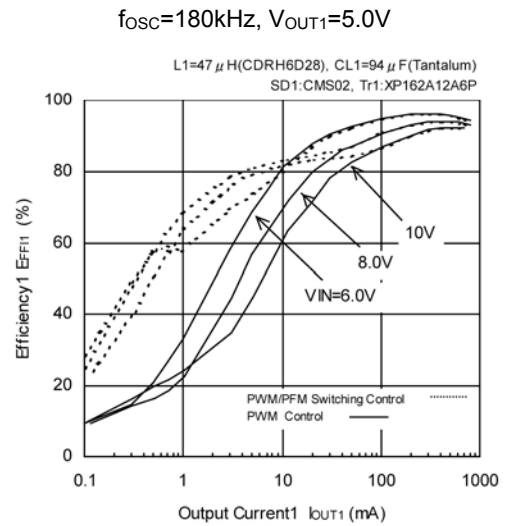
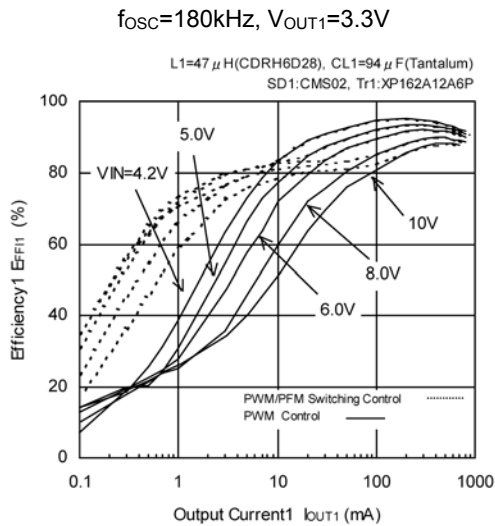
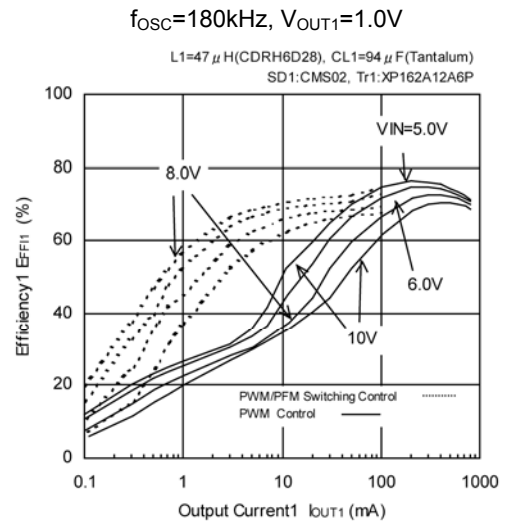
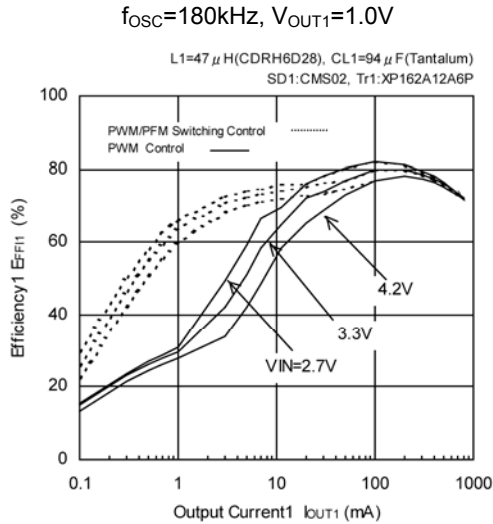

\* When setting  $V_{OUT1}=1.0V$ ,  $V_{IN}=8.0V$  or  $10.0V$ ,  
CL=94  $\mu$ F (Tantalum) + 100  $\mu$ F (OS Capacitor)

## ■ TYPICAL PERFORMANCE CHARACTERISTICS (Continued)

< 1 ch Step-Down DC/DC Controller > (Continued)

(2) Efficiency vs. Output Current (Continued)

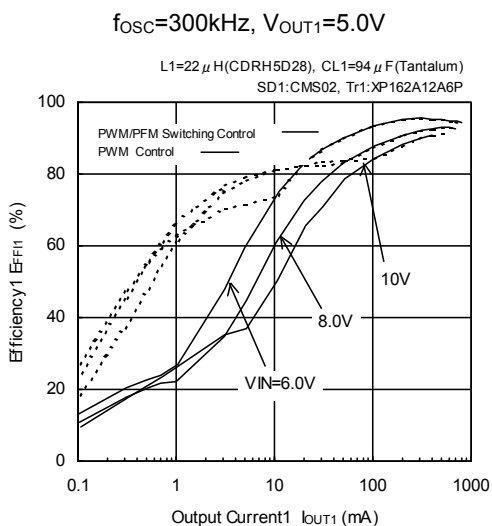
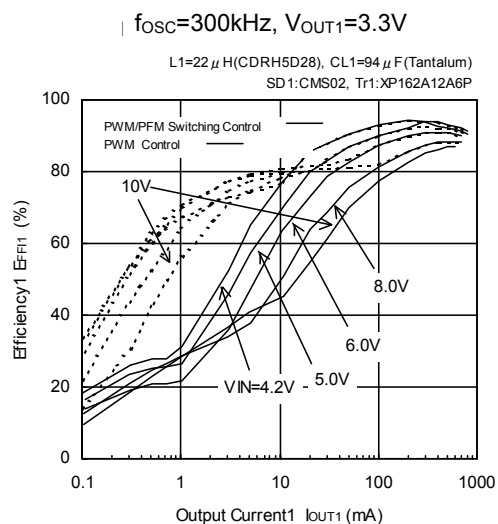
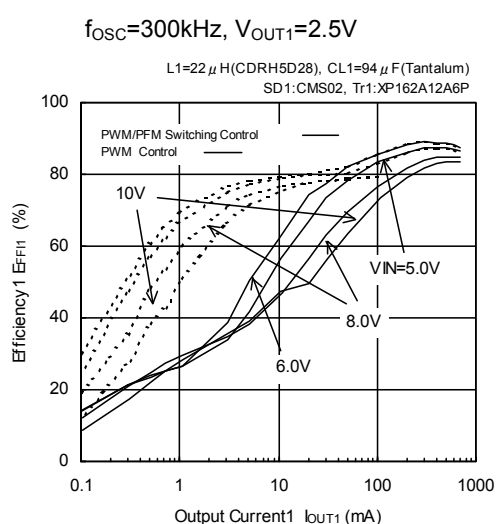
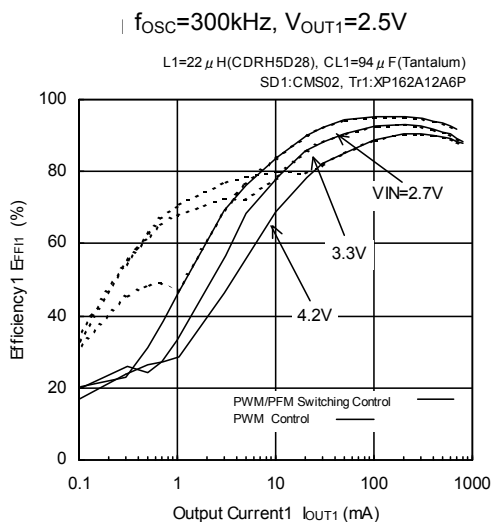
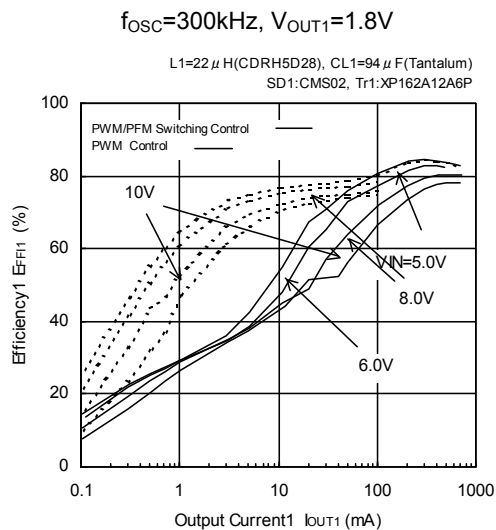
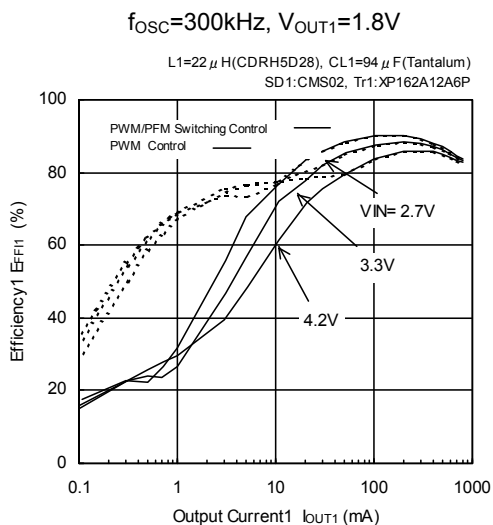

\* When setting  $V_{OUT1}=1.0V$ ,  $V_{IN}=8.0V$  or  $10.0V$ ,  
CL=94  $\mu$  F (Tantalum) + 100  $\mu$  F (OS Capacitor)

## TYPICAL PERFORMANCE CHARACTERISTICS (Continued)

< 1 ch Step-Down DC/DC Controller > (Continued)

(2) Efficiency vs. Output Current (Continued)

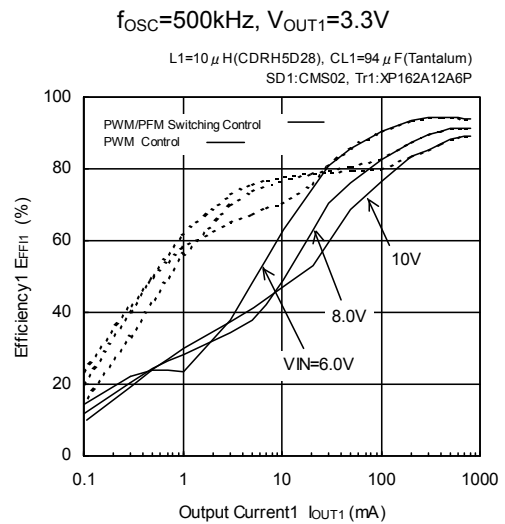
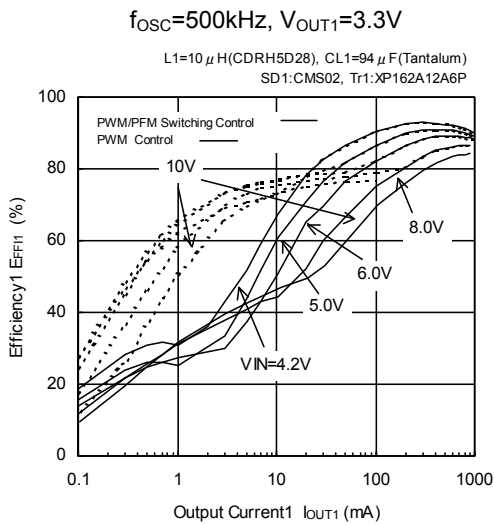
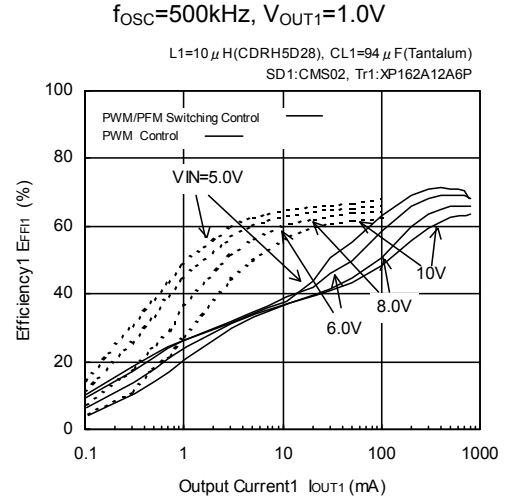
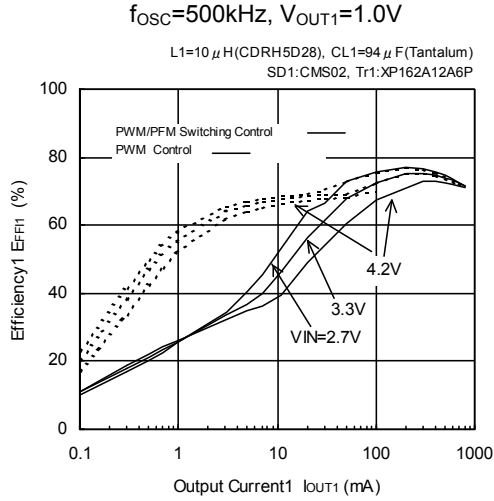

\* When setting  $V_{OUT1}=1.0V, V_{IN}=8.0V$  or  $10.0V,$   
 $CL=94\mu F$  (Tantalum) +  $100\mu F$  (OS Capacitor)

## ■ TYPICAL PERFORMANCE CHARACTERISTICS (Continued)

< 1 ch Step-Down DC/DC Controller > (Continued)

(3) Ripple Voltage vs. Output Current

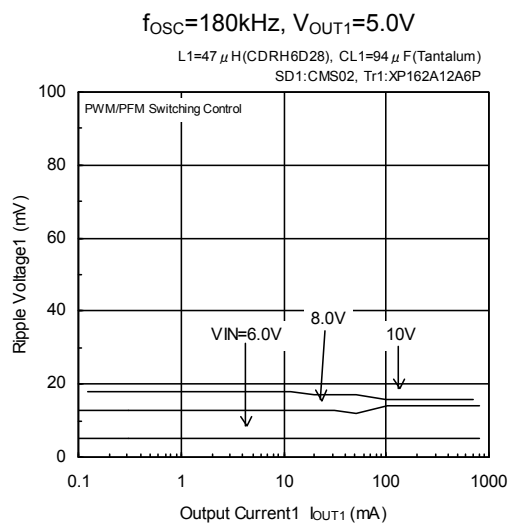
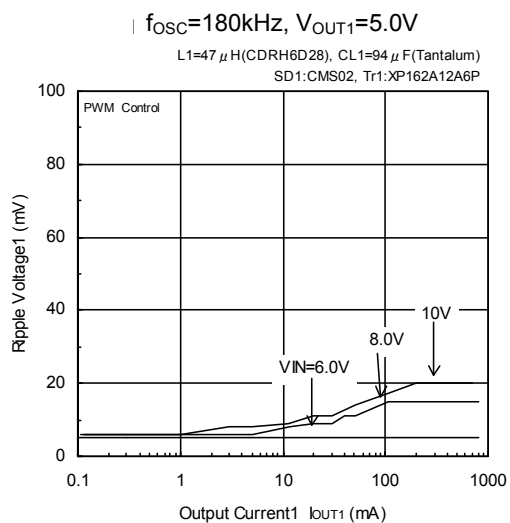
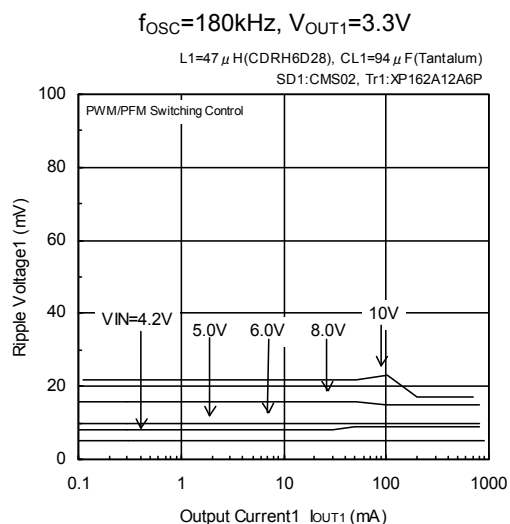
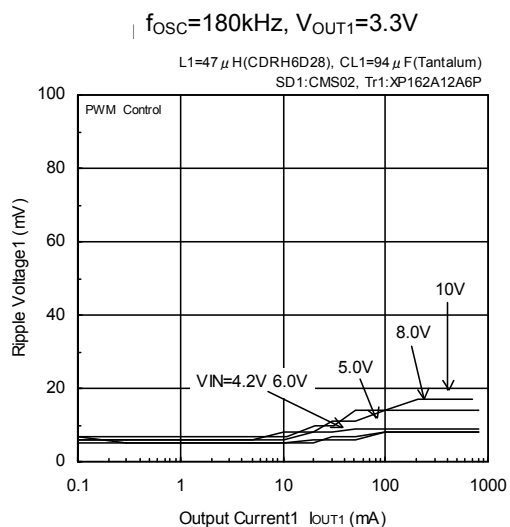
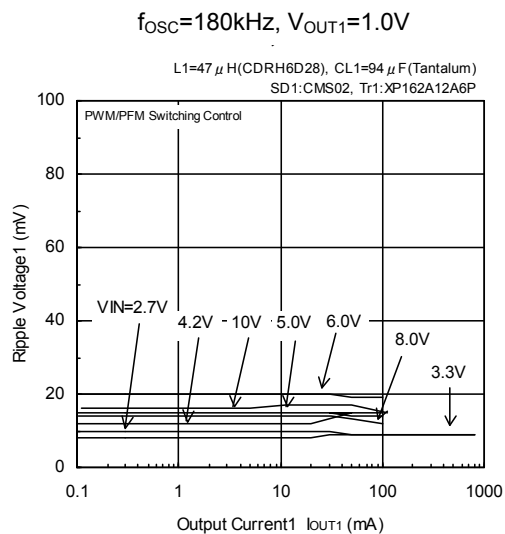
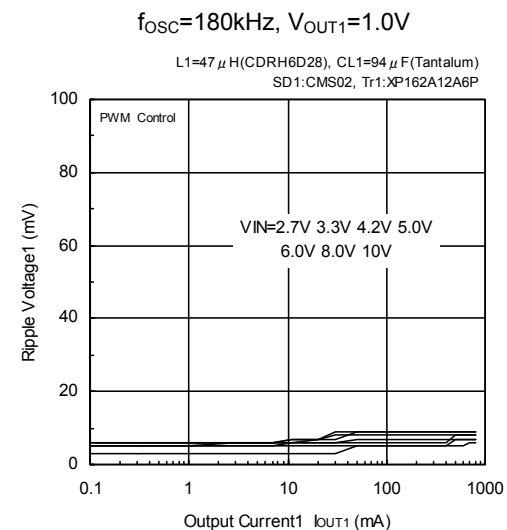

\* When setting  $V_{OUT1}=1.0V$ ,  $V_{IN}=8.0V$  or  $10.0V$ ,  
CL=94  $\mu$ F (Tantalum) + 100  $\mu$ F (OS Capacitor)

## ■ TYPICAL PERFORMANCE CHARACTERISTICS (Continued)

< 1 ch Step-Down DC/DC Controller > (Continued)

(3) Ripple Voltage vs. Output Current (Continued)

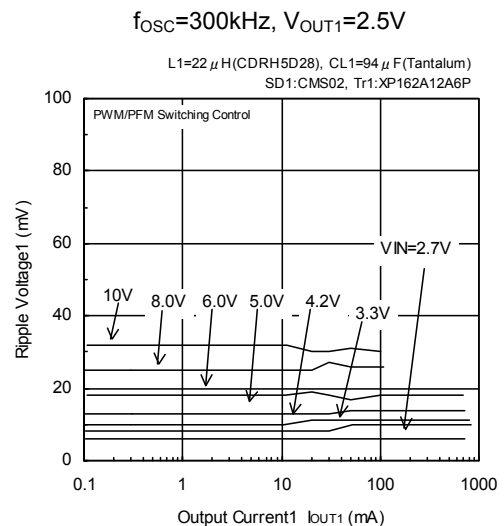
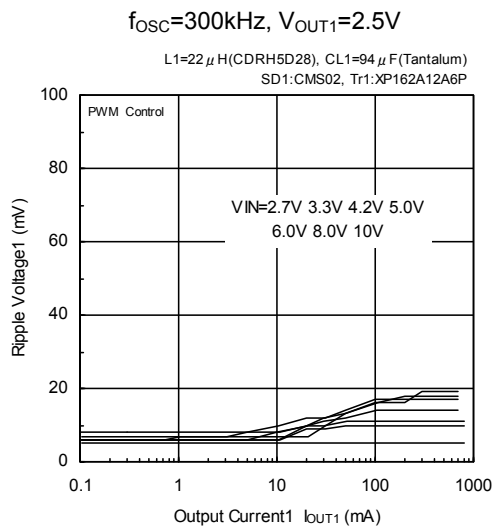
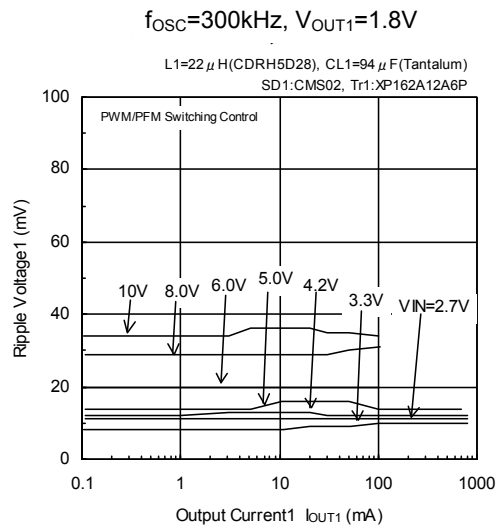
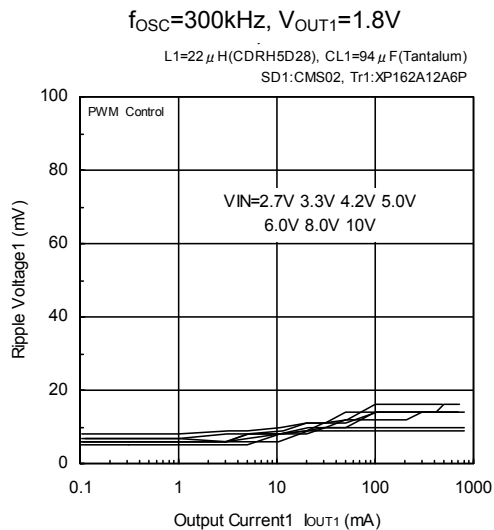
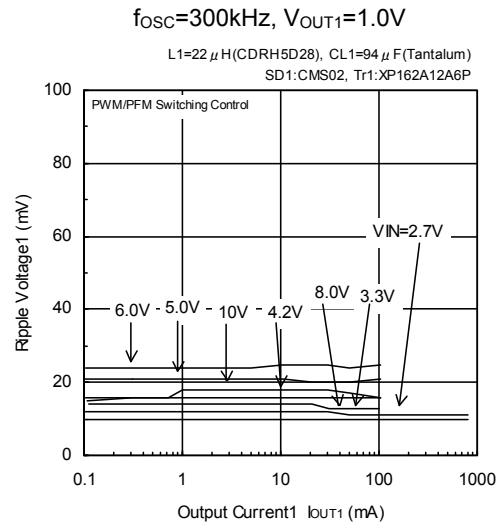
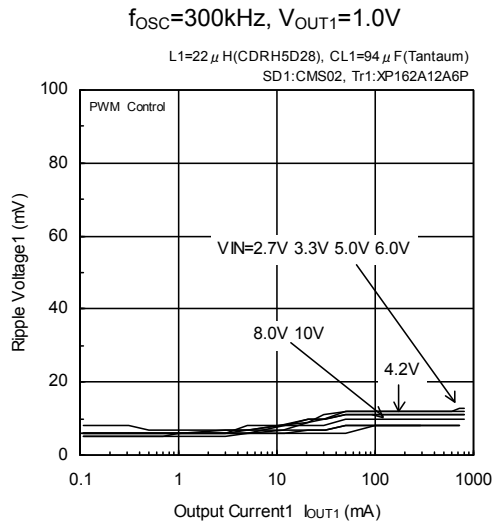

\* When setting  $V_{OUT1}=1.0V$ ,  $V_{IN}=8.0V$  or  $10.0V$ ,  
 $CL=94\mu F$  (Tantalum) +  $100\mu F$  (OS Capacitor)

## ■ TYPICAL PERFORMANCE CHARACTERISTICS (Continued)

< 1 ch Step-Down DC/DC Controller > (Continued)

(3) Ripple Voltage vs. Output Current (Continued)

$f_{OSC}=300kHz, V_{OUT1}=3.3V$

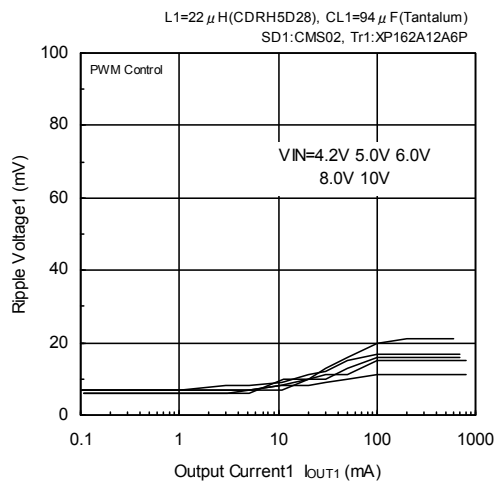

$f_{OSC}=300kHz, V_{OUT1}=3.3V$

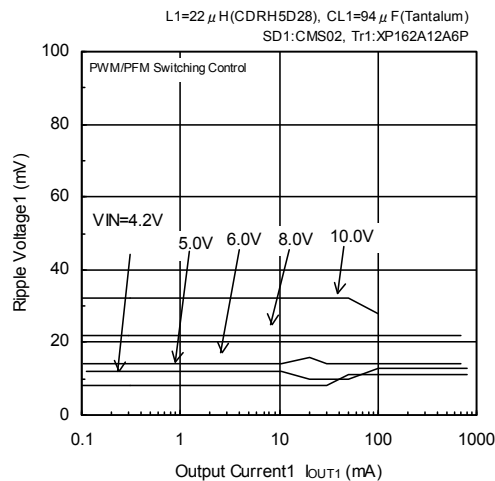

$f_{OSC}=300kHz, V_{OUT1}=5.0V$

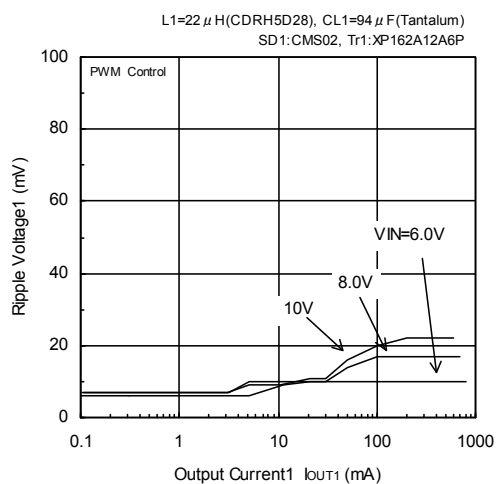

$f_{OSC}=300kHz, V_{OUT1}=5.0V$

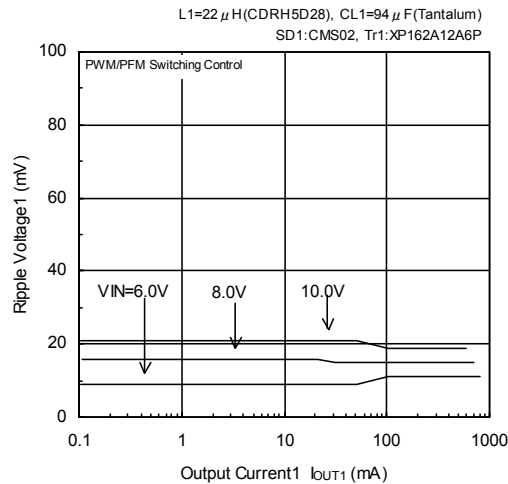

$f_{OSC}=500kHz, V_{OUT1}=1.0V$

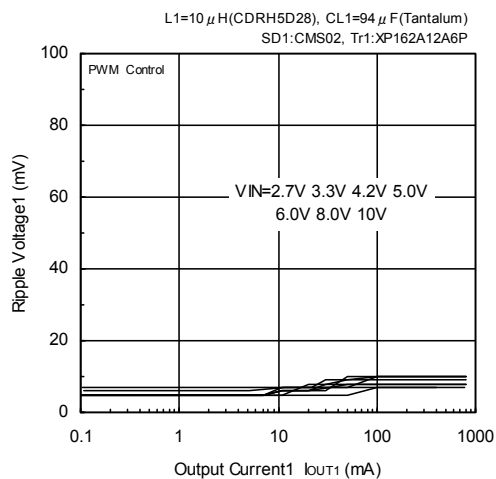

$f_{OSC}=500kHz, V_{OUT1}=1.0V$

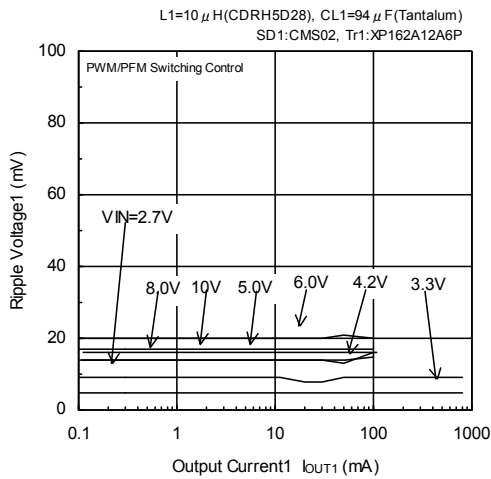

\* When setting  $V_{OUT1}=1.0V$ ,  $V_{IN}=8.0V$  or  $10.0V$ ,  
 $CL=94 \mu F$  (Tantalum) +  $100 \mu F$  (OS Capacitor)

## TYPICAL PERFORMANCE CHARACTERISTICS (Continued)

< 1 ch Step-Down DC/DC Controller > (Continued)

(3) Ripple Voltage vs. Output Current (Continued)

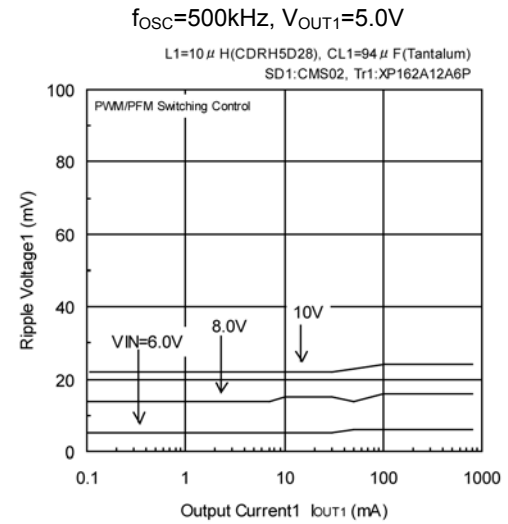
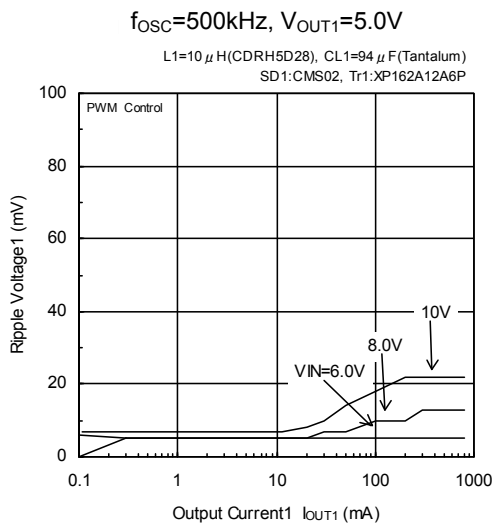
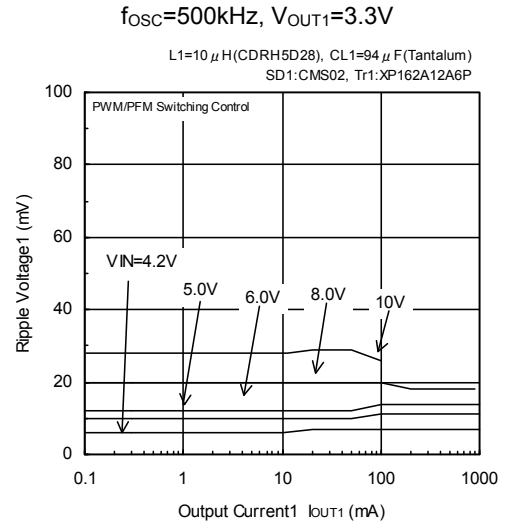
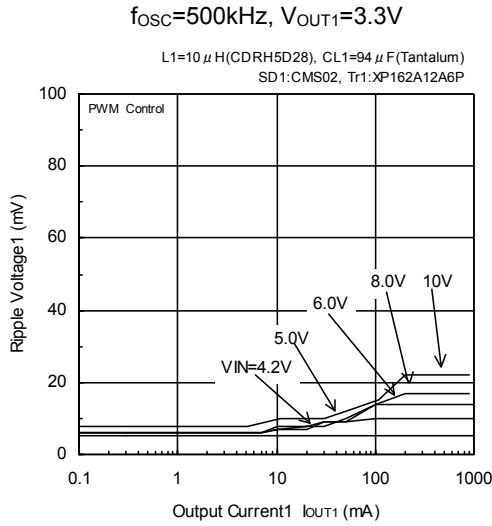

\* When setting  $V_{OUT1}=1.0V$ ,  $V_{IN}=8.0V$  or  $10.0V$ ,  
 $C_L=94 \mu F$  (Tantalum) +  $100 \mu F$  (OS Capacitor)



## ■ TYPICAL PERFORMANCE CHARACTERISTICS (Continued)

< 2 ch. Inverting DC/DC Controller >

(4) Output Voltage vs. Output Current

<Ceramic capacitor and compact inductor use>

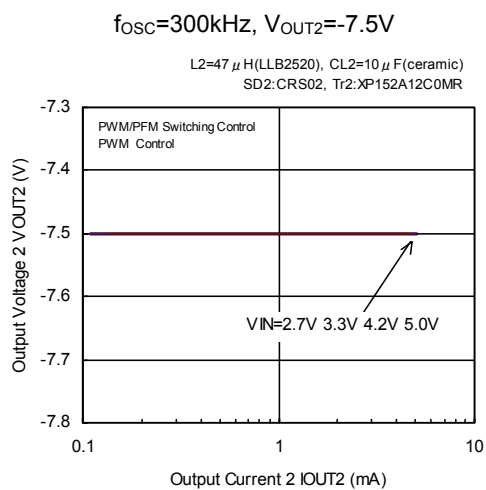
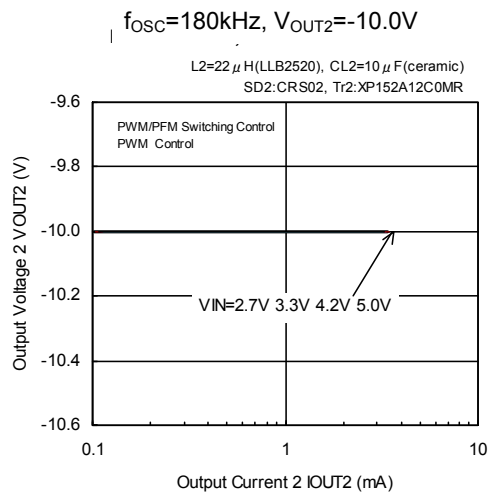
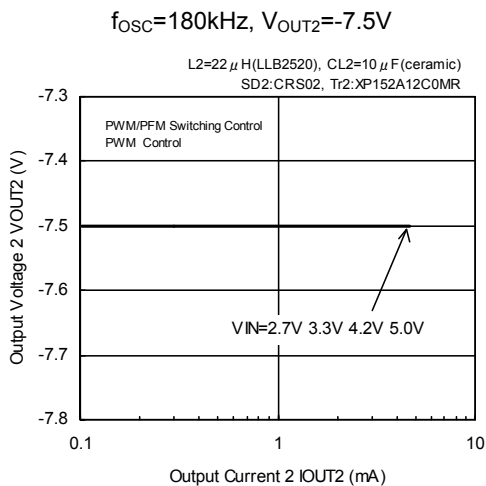

## ■ TYPICAL PERFORMANCE CHARACTERISTICS (Continued)

< 2 ch. Inverting DC/DC Controller > (Continued)

(4) Output Voltage vs. Output Current (Continued)

<Ceramic capacitor use>

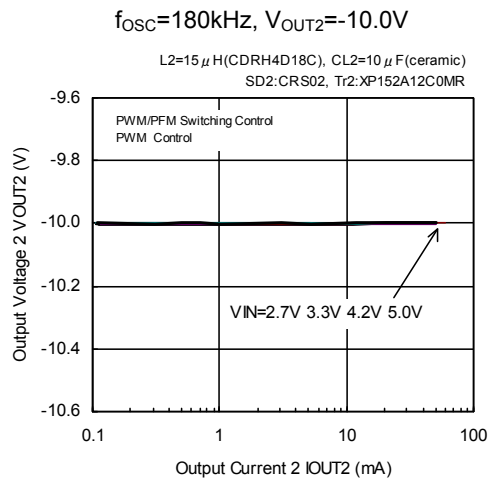
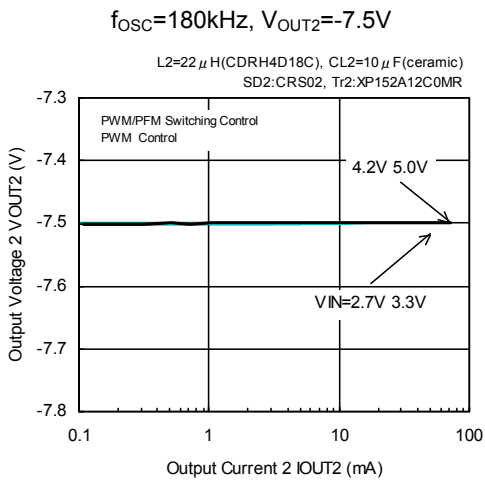
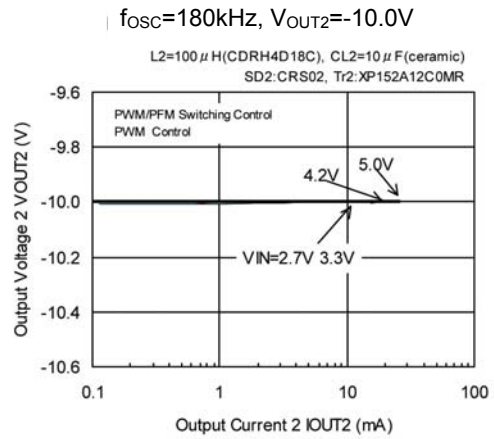
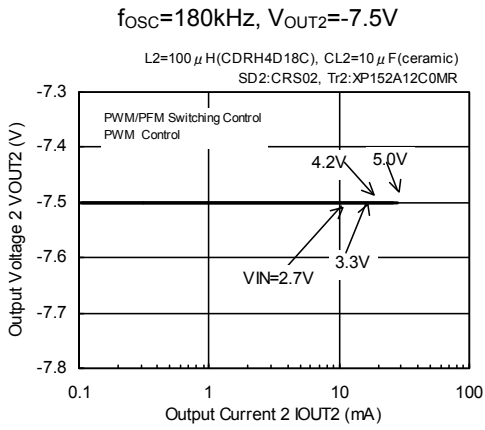

## ■ TYPICAL PERFORMANCE CHARACTERISTICS (Continued)

< 2 ch. Inverting DC/DC Controller > (Continued)

(4) Output Voltage vs. Output Current (Continued)

<Ceramic capacitor use>

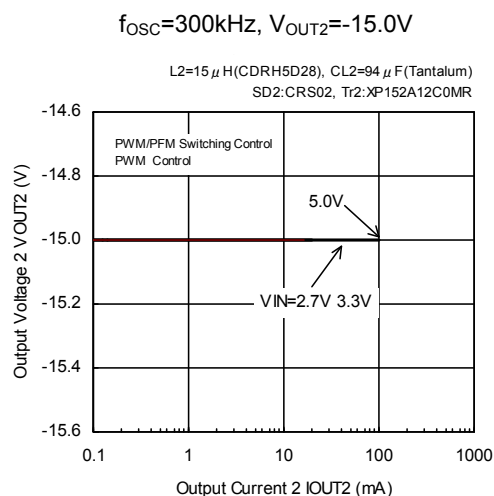
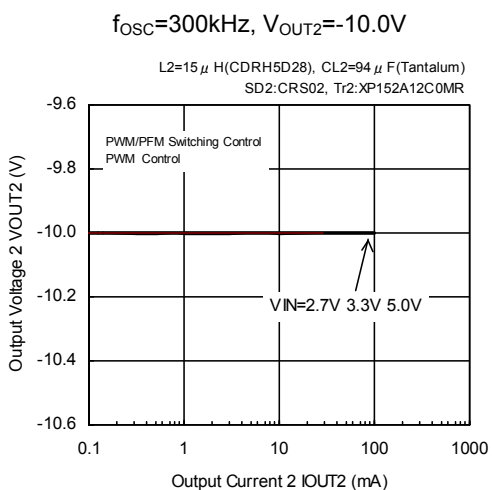
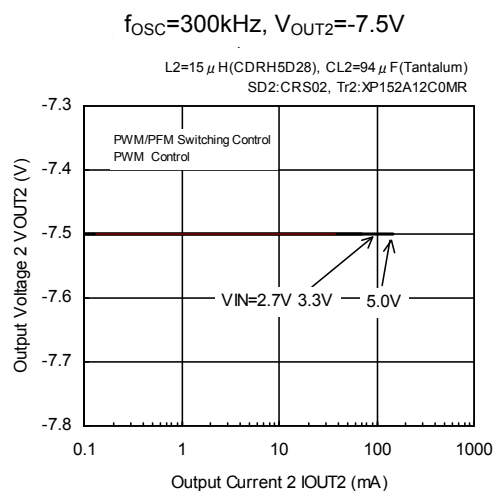
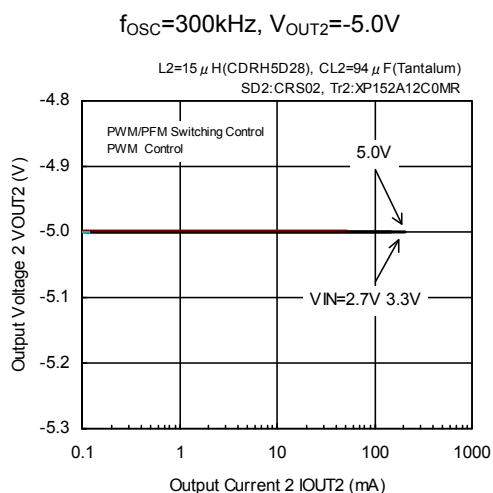
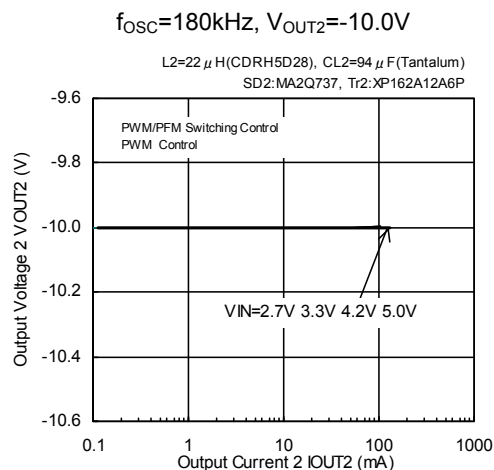
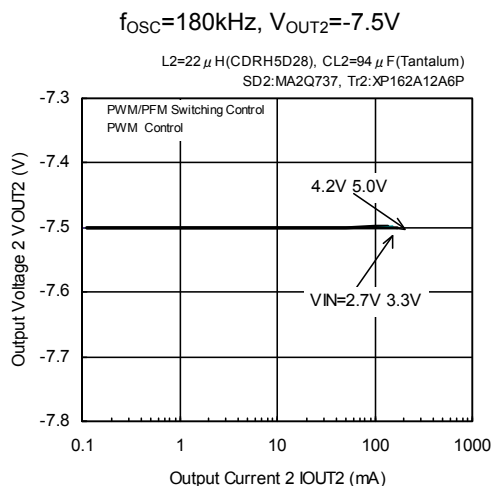

## ■ TYPICAL PERFORMANCE CHARACTERISTICS (Continued)

< 2 ch. Inverting DC/DC Controller > (Continued)

(5) Efficiency vs. Output Current

<Ceramic capacitor and compact inductor use>

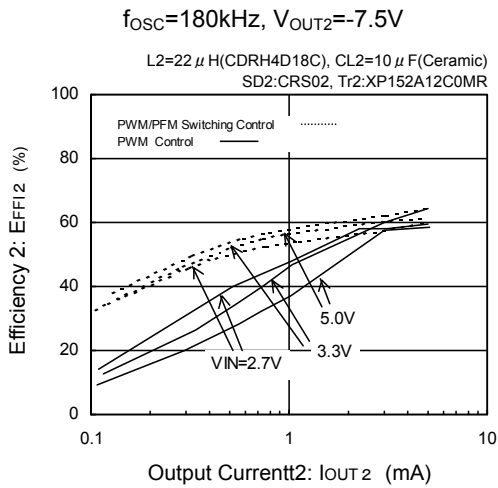
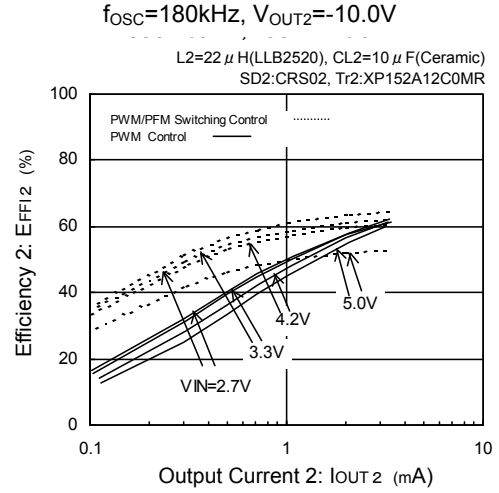
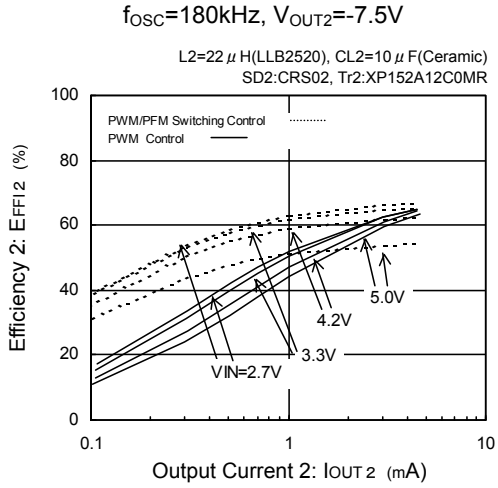

## ■ TYPICAL PERFORMANCE CHARACTERISTICS (Continued)

< 2 ch. Inverting DC/DC Controller > (Continued)

(5) Efficiency vs. Output Current (Continued)

<Ceramic capacitor use>

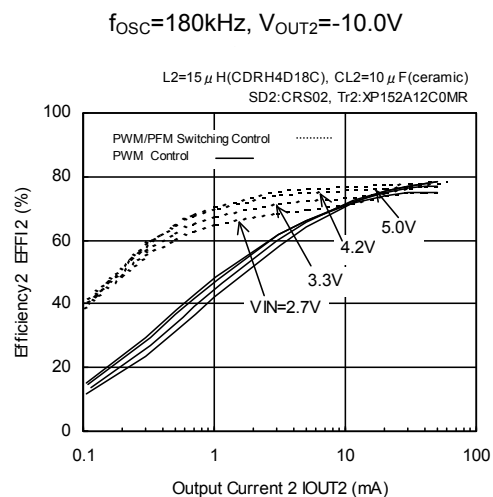
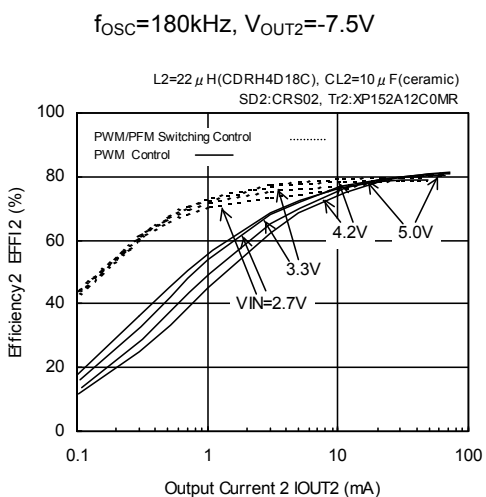
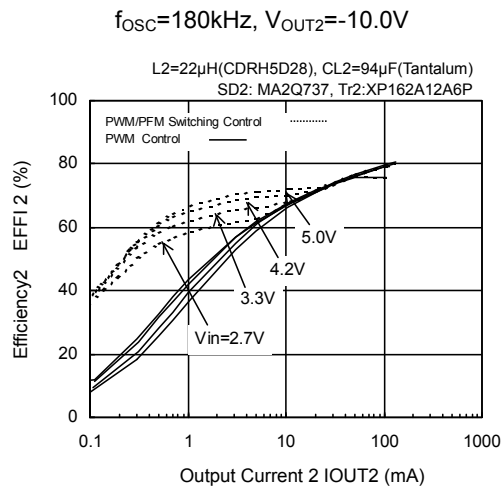
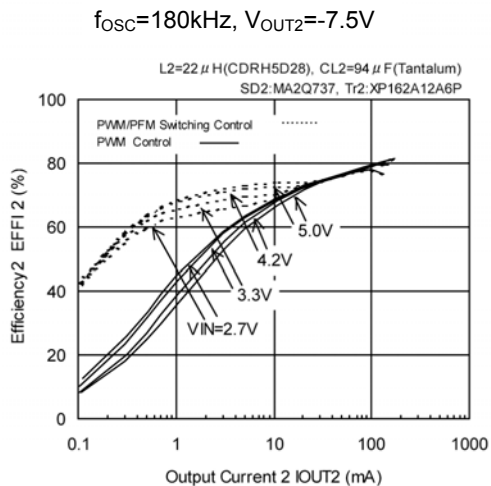

## ■ TYPICAL PERFORMANCE CHARACTERISTICS (Continued)

< 2 ch. Inverting DC/DC Controller > (Continued)

(5) Efficiency vs. Output Current (Continued)

<Tantalum capacitor use>

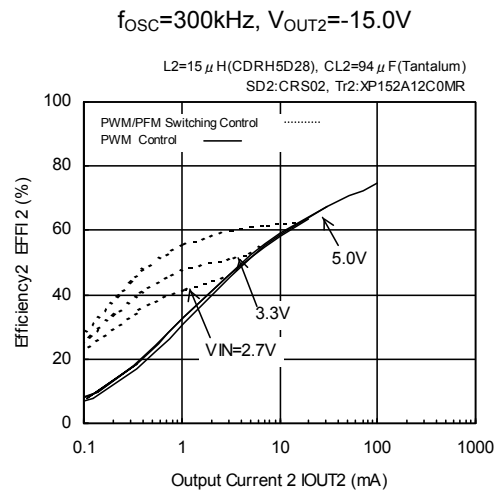
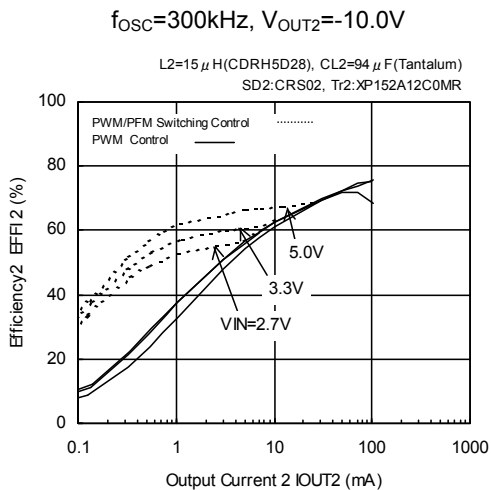
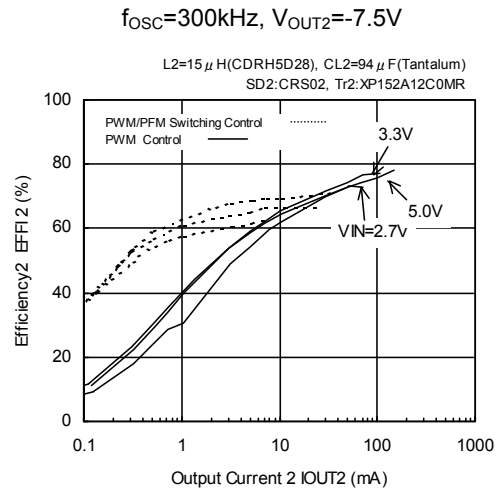
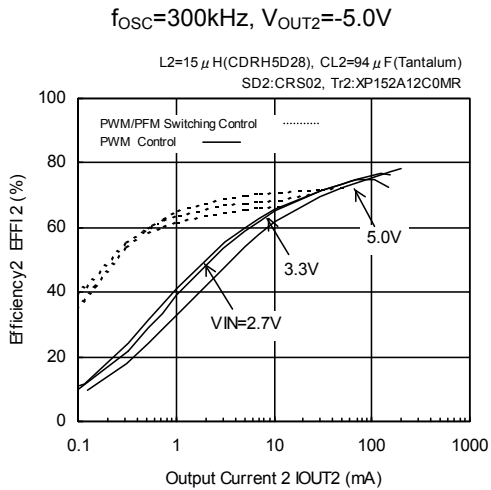
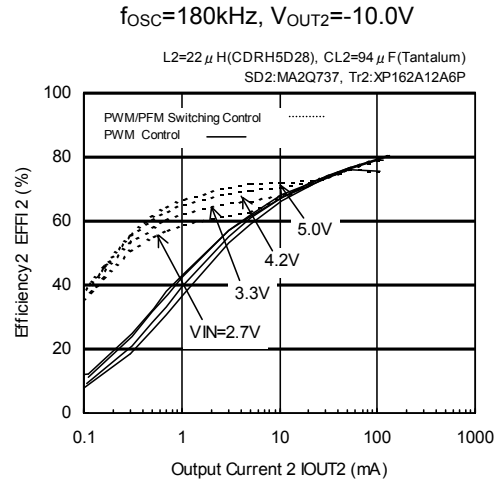
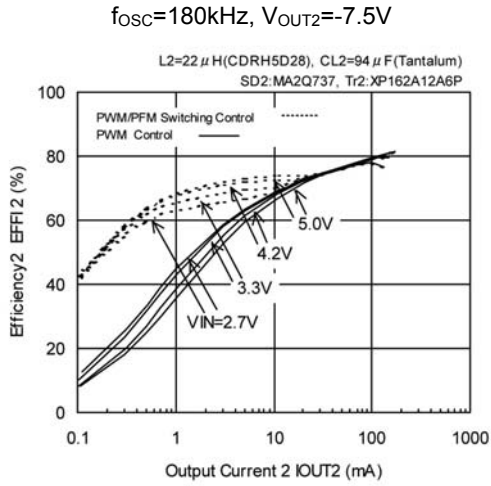

## ■ TYPICAL PERFORMANCE CHARACTERISTICS (Continued)

< 2 ch. Inverting DC/DC Controller > (Continued)

(6) Ripple Voltage vs. Output Current

<Ceramic capacitor and compact inductor use>

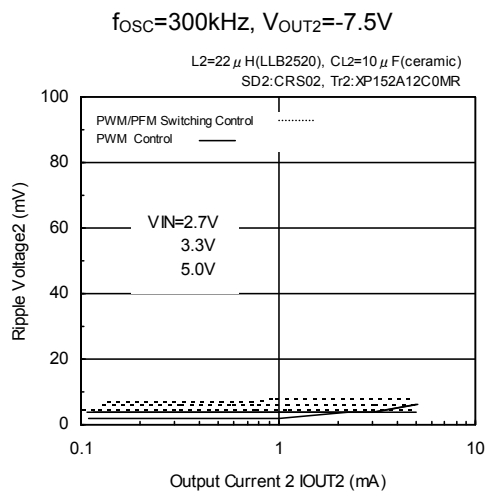
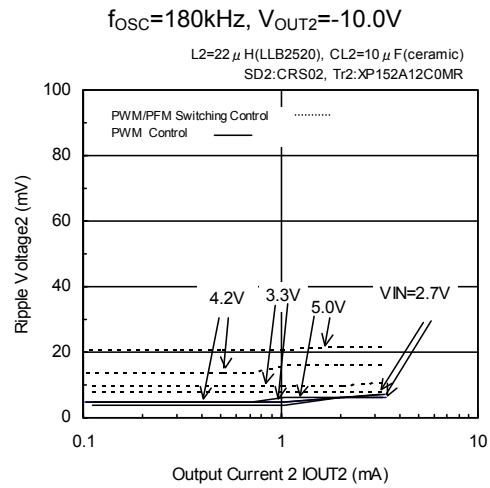
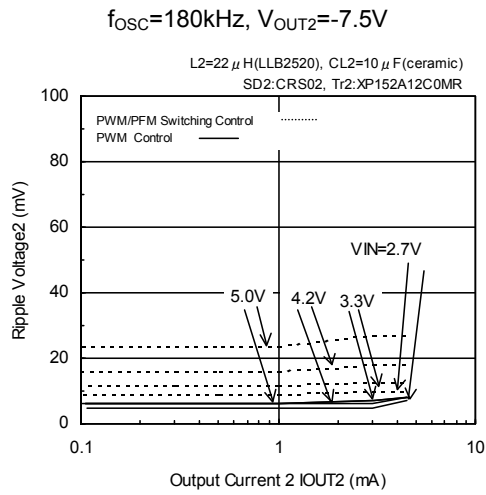

## TYPICAL PERFORMANCE CHARACTERISTICS (Continued)

< 2 ch. Inverting DC/DC Controller > (Continued)

(6) Ripple Voltage vs. Output Current (Continued)

<Ceramic capacitor use>

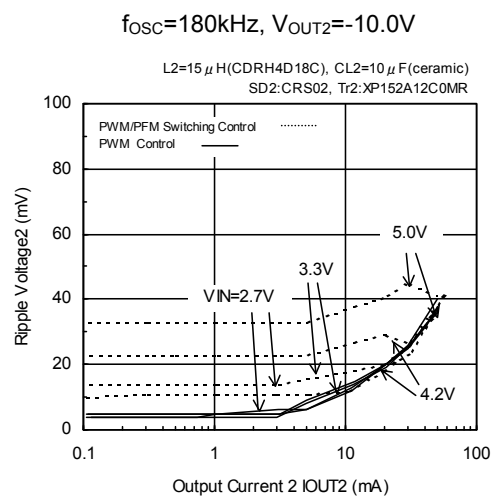
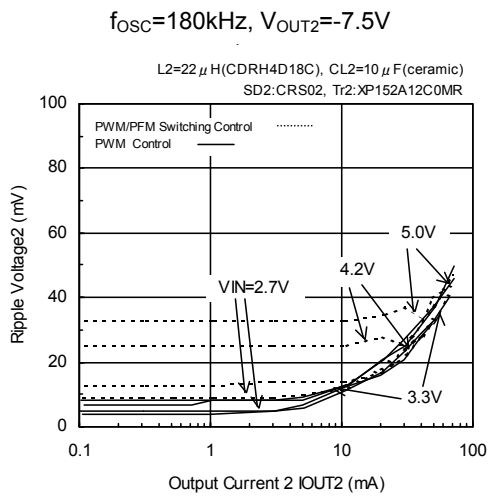
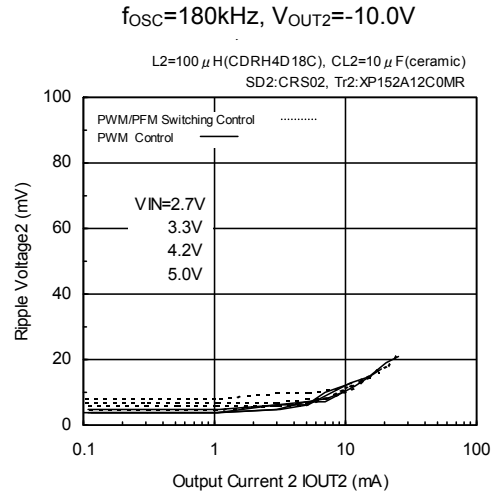
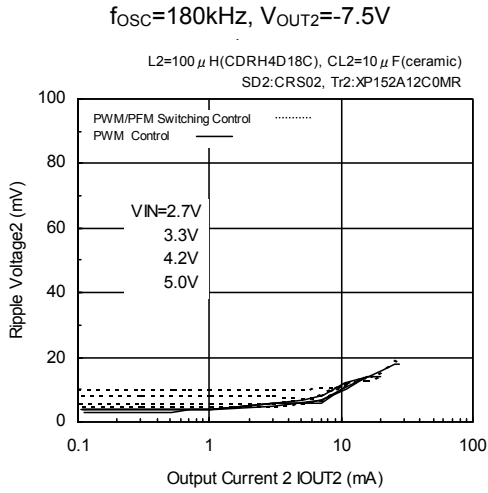



## ■ TYPICAL PERFORMANCE CHARACTERISTICS (Continued)

< 2 ch. Inverting DC/DC Controller > (Continued)

(6) Ripple Voltage vs. Output Current (Continued)

<Tantalum capacitor use>

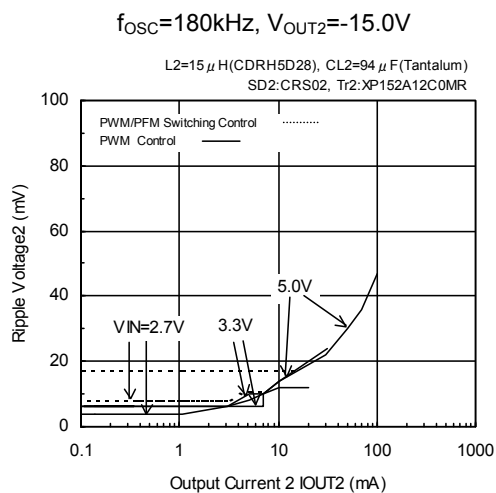
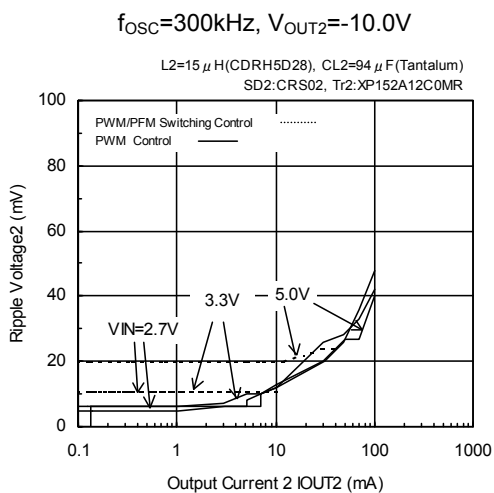
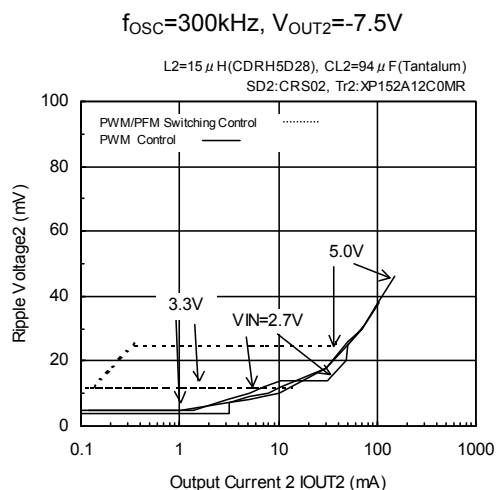
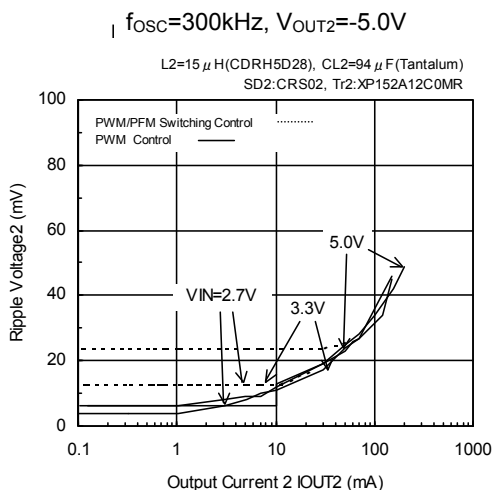
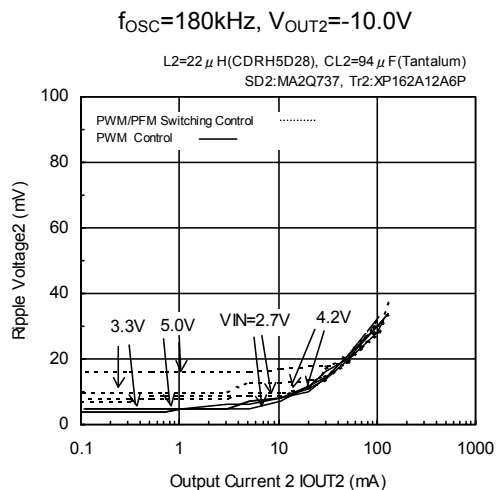
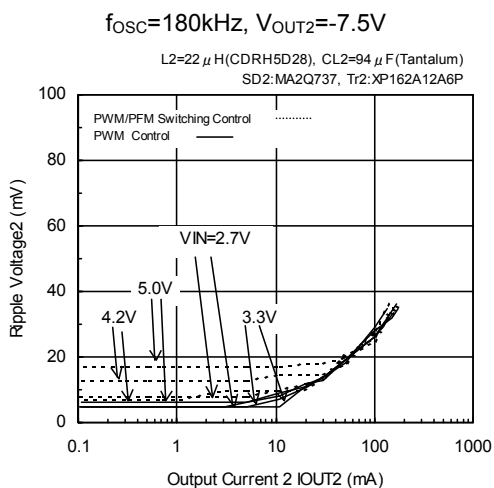

## TYPICAL PERFORMANCE CHARACTERISTICS (Continued)

< 2 ch. Inverting DC/DC Controller > (Continued)

(7) Breakdown of Output Voltage

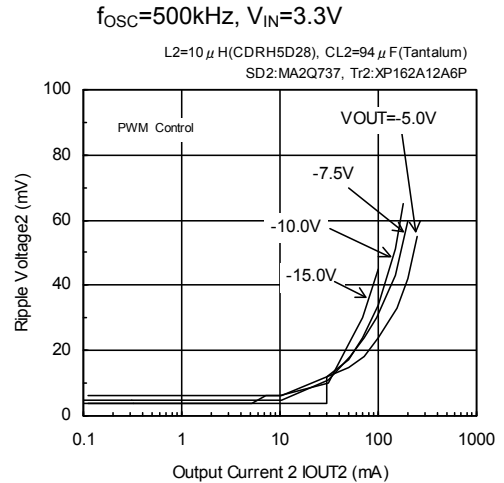
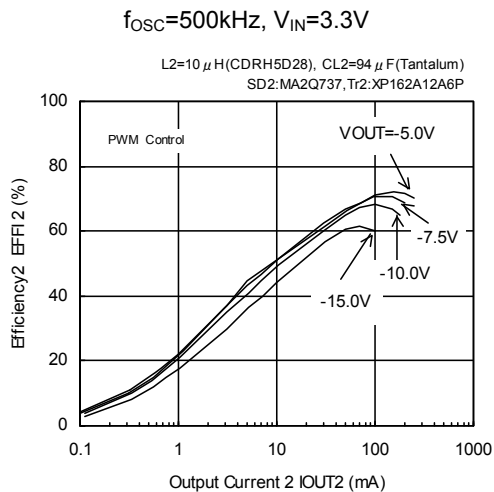
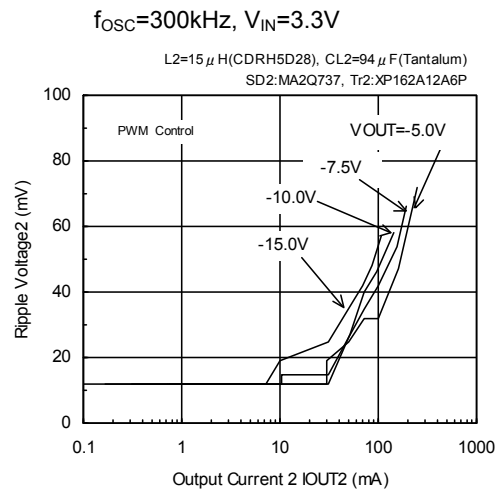
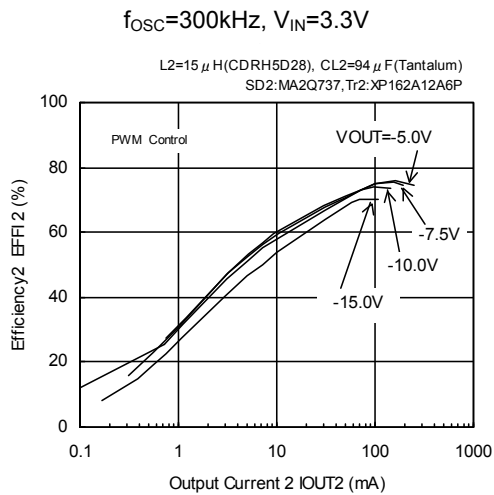
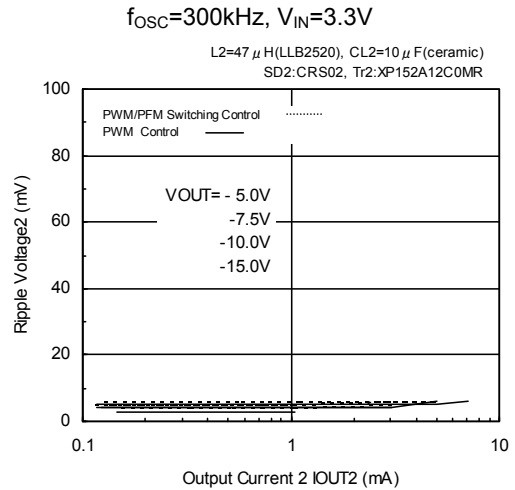
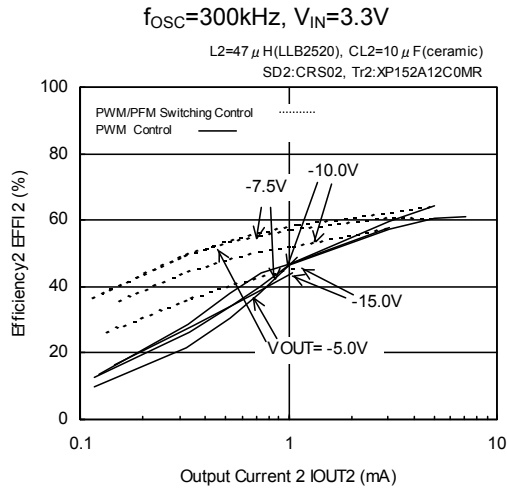

## ■ TYPICAL PERFORMANCE CHARACTERISTICS (Continued)

< 2 ch. Inverting DC/DC Controller > (Continued)

(8) Breakdown of Coil Inductance Value

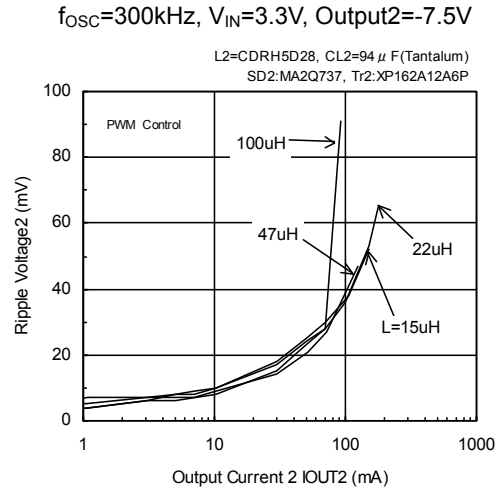
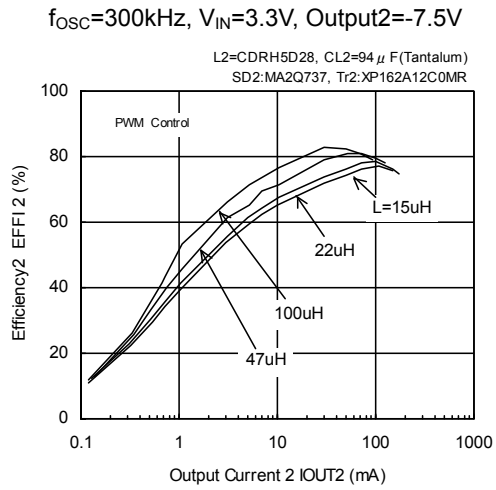

## TYPICAL PERFORMANCE CHARACTERISTICS (Continued)

(9) Supply Current 1 vs. Supply Voltage

**XC9505B092 (180KHz)**

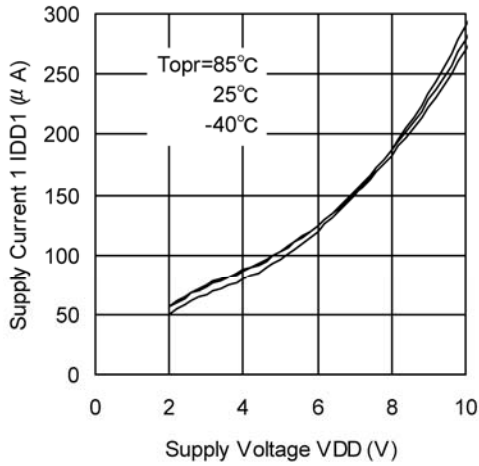

(10) Supply Current 1-1 vs. Supply Voltage

**XC9505B092 (180KHz)**

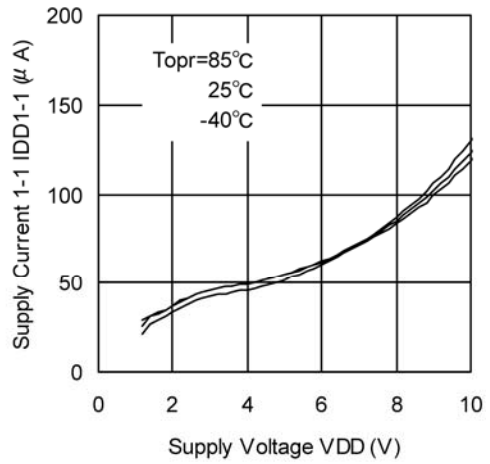

(11) Supply Current 1-2 vs. Supply Voltage

**XC9505B092 (180KHz)**

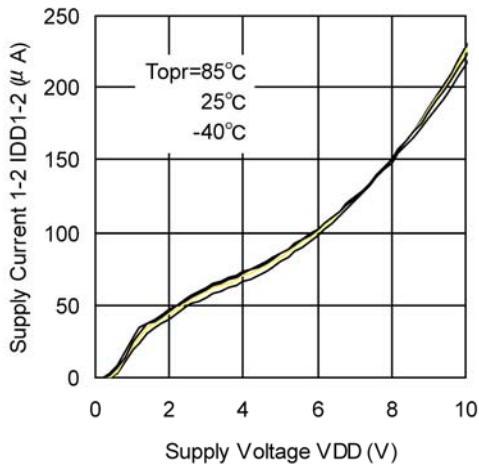

(12) Supply Current 1-3 vs. Supply Voltage

**XC9505B095 (180KHz)**

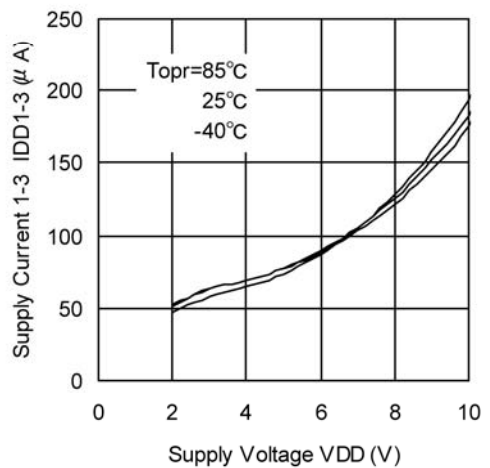

(13) Supply Current 1-4 vs. Supply Voltage

**XC9505B092 (180KHz)**

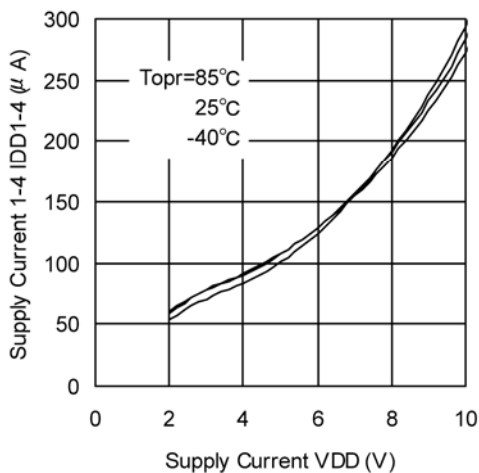

(14) Supply Current 2 vs. Supply Voltage

**XC9505B092 (180KHz)**

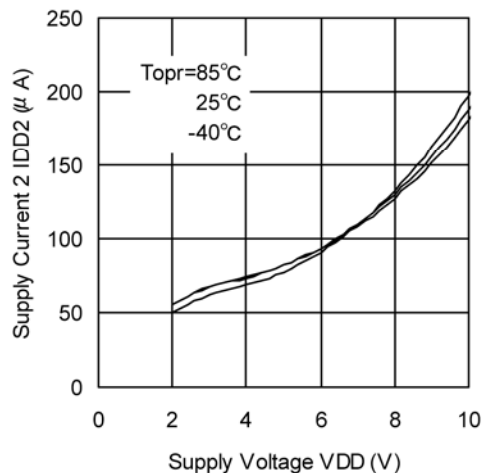

## ■ TYPICAL PERFORMANCE CHARACTERISTICS (Continued)

(15) Stand-by Current vs. Supply Voltage

**XC9505B092 (180kHz)**

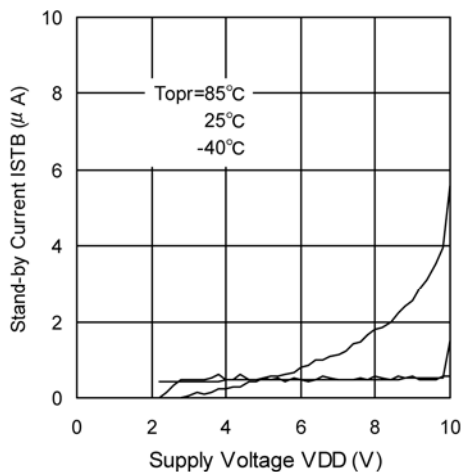

(16) Oscillation Frequency vs. Supply Voltage

**XC9505B092 (180kHz)**

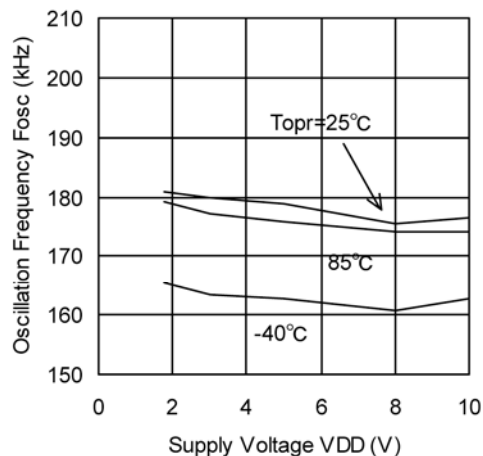

(17) PWM1, 2 'H' 'L' Voltage vs. Supply Voltage

**XC9505B092 (180kHz)**

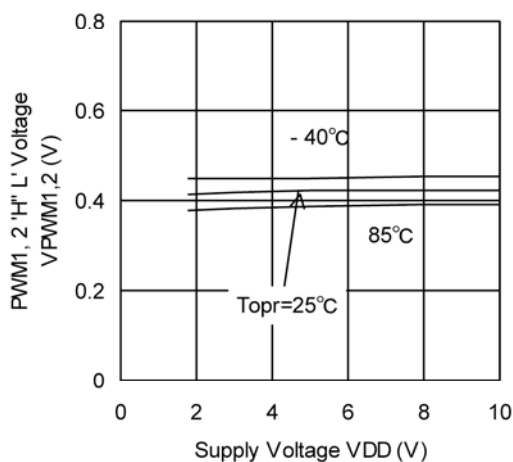

(18) EN1, 2 'H' 'L' Voltage vs. Supply Voltage

**XC9505B092 (180kHz)**

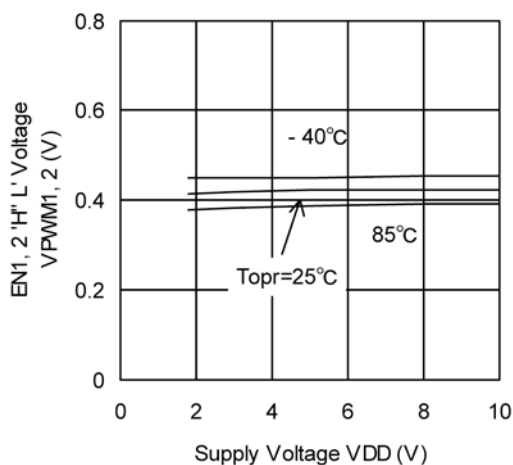

(19) MAX. Duty Ratio 2 vs. Supply Voltage

**XC9505B092 (180kHz)**

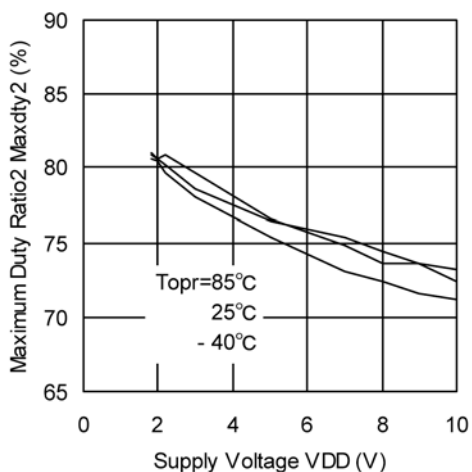

(20) Soft-start Time vs. Supply Voltage

**XC9505B092 (180kHz)**

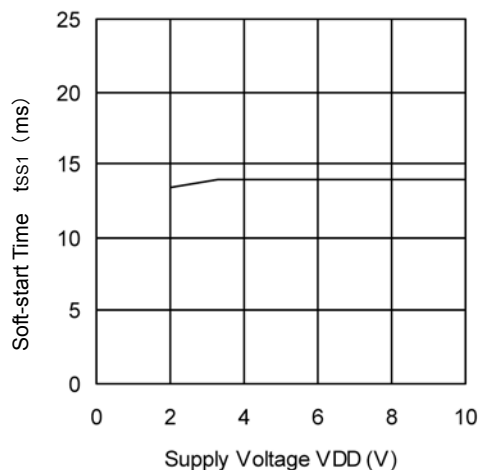

## TYPICAL PERFORMANCE CHARACTERISTICS (Continued)

(21) EXT1, 2 High ON Resistance vs. Supply Voltage

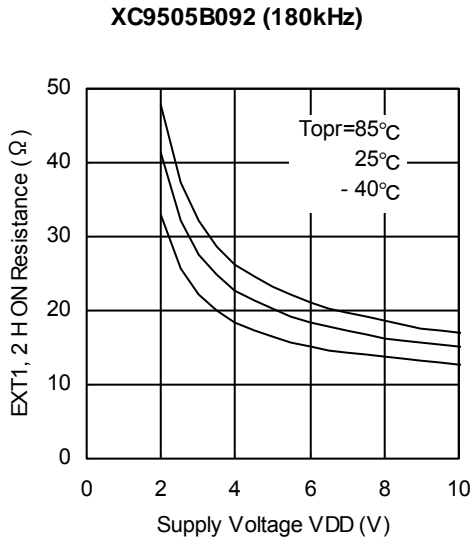

(22) EXT1, 2 Low ON Resistance vs. Supply Voltage

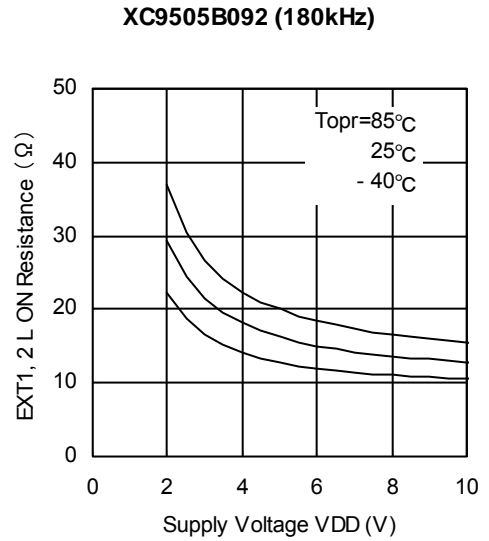

(23) Output Voltage vs. Ambient Temperature

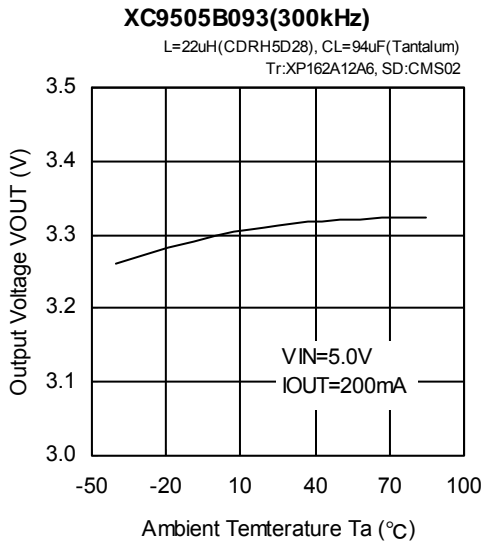

(24) PFM Duty Ratio1, 2 vs. Supply Voltage

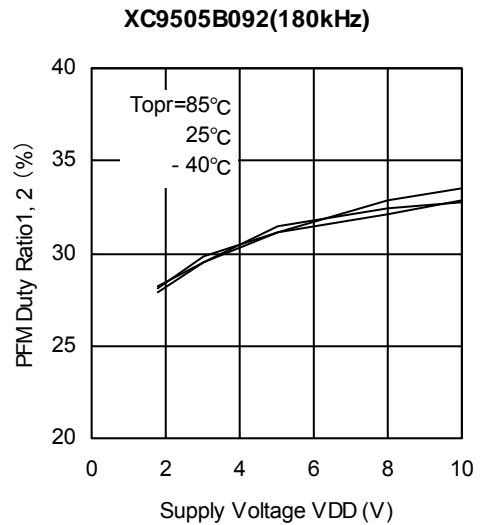

## ■ TYPICAL PERFORMANCE CHARACTERISTICS (Continued)

< 1 ch. Step-Up DC/DC Controller >

(25) Load Transient Response

<  $V_{OUT1} = 3.3V$ ,  $V_{IN} = 5.0V$ ,  $I_{OUT1} = 100\mu A \leftrightarrow 300mA$  >

### ● PWM Control

$f_{OSC} = 300kHz$ ,  $V_{OUT1} = 3.3V$   
 $V_{IN} = 5.0V$ ,  $I_{OUT1} = 100\mu A \rightarrow 300mA$

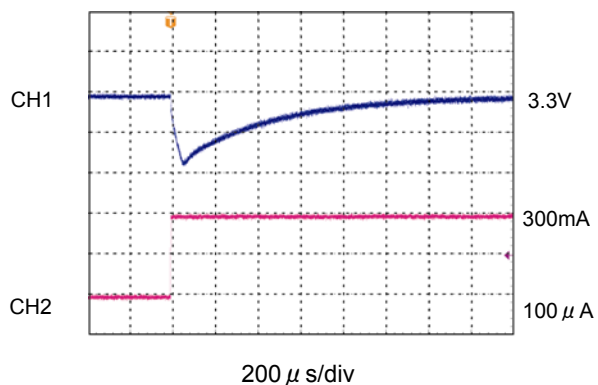

CH1:  $V_{OUT1}$ , AC-COUPLED, 100mV/div  
CH2:  $I_{OUT1}$ , 150mA/div

$f_{OSC} = 300kHz$ ,  $V_{OUT1} = 3.3V$   
 $V_{IN} = 5.0V$ ,  $I_{OUT1} = 300mA \rightarrow 100\mu A$

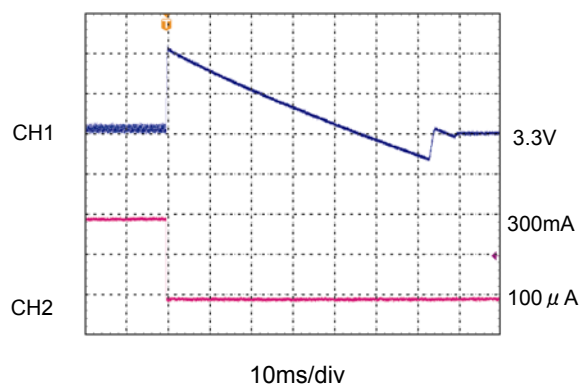

CH1:  $V_{OUT1}$ , AC-COUPLED, 50mV/div  
CH2:  $I_{OUT1}$ , 150mA/div

### ● PWM/PFM Switching Control

$f_{OSC} = 300kHz$ ,  $V_{OUT1} = 3.3V$   
 $V_{IN} = 5.0V$ ,  $I_{OUT1} = 100\mu A \rightarrow 300mA$

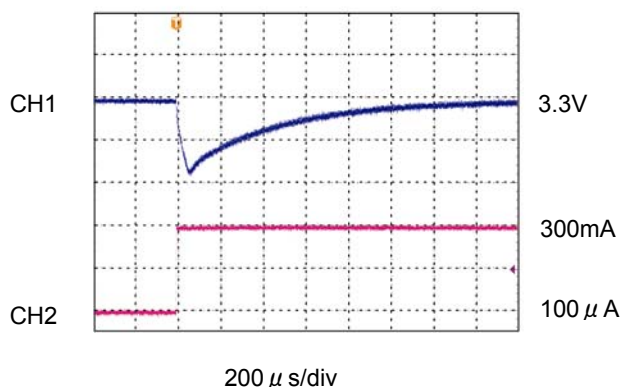

CH1:  $V_{OUT1}$ , AC-COUPLED, 100mV/div  
CH2:  $I_{OUT1}$ , 150mA/div

$f_{OSC} = 300kHz$ ,  $V_{OUT1} = 3.3V$   
 $V_{IN} = 5.0V$ ,  $I_{OUT1} = 300mA \rightarrow 100\mu A$

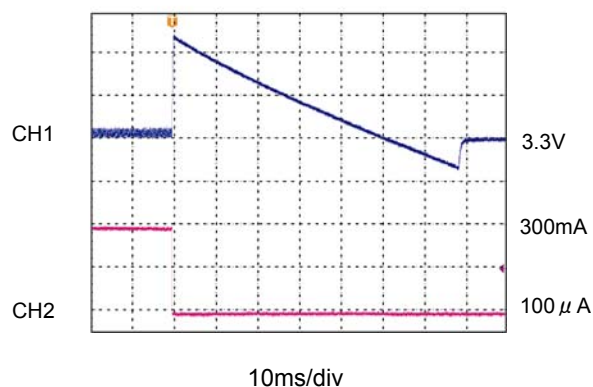

CH1:  $V_{OUT1}$ , AC-COUPLED, 100mV/div  
CH2:  $I_{OUT1}$ , 150mA/div

## TYPICAL PERFORMANCE CHARACTERISTICS (Continued)

< 1 ch. Step-Up DC/DC Controller > (Continued)

(25) Load Transient Response (Continued)

<  $V_{OUT1} = 3.3V$ ,  $V_{IN} = 5.0V$ ,  $I_{OUT1} = 10mA \leftrightarrow 300mA$  >

### ● PWM Control

$f_{osc} = 300kHz$ ,  $V_{OUT1} = 3.3V$   
 $V_{IN} = 5.0V$ ,  $I_{OUT1} = 10mA \rightarrow 300mA$

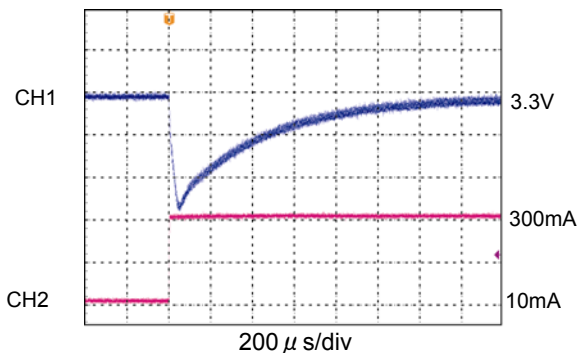

CH1:  $V_{OUT1}$ , AC-COUPLED, 50mV/div  
 CH2:  $I_{OUT1}$ , 150mA/div

$f_{osc} = 300kHz$ ,  $V_{OUT1} = 3.3V$   
 $V_{IN} = 5.0V$ ,  $I_{OUT1} = 300mA \rightarrow 10mA$

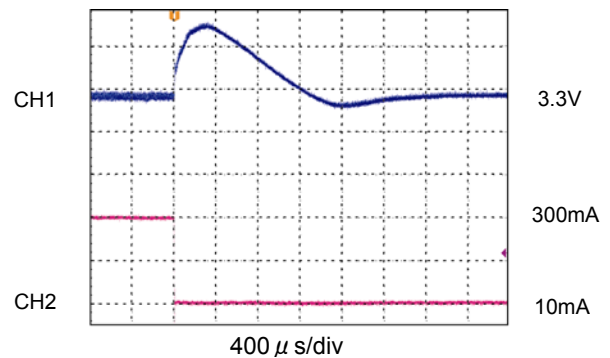

CH1:  $V_{OUT1}$ , AC-COUPLED, 50mV/div  
 CH2:  $I_{OUT1}$ , 150mA/div

### ● PWM/PFM Switching Control

$f_{osc} = 300kHz$ ,  $V_{OUT1} = 3.3V$   
 $V_{IN} = 5.0V$ ,  $I_{OUT1} = 10mA \rightarrow 300mA$

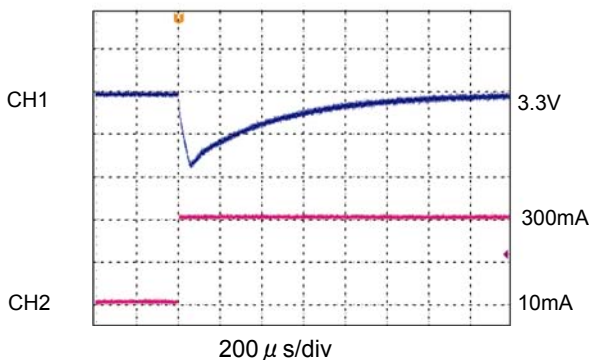

CH1:  $V_{OUT1}$ , AC-COUPLED, 100mV/div  
 CH2:  $I_{OUT1}$ , 150mA/div

$f_{osc} = 300kHz$ ,  $V_{OUT1} = 3.3V$   
 $V_{IN} = 5.0V$ ,  $I_{OUT1} = 300mA \rightarrow 10mA$

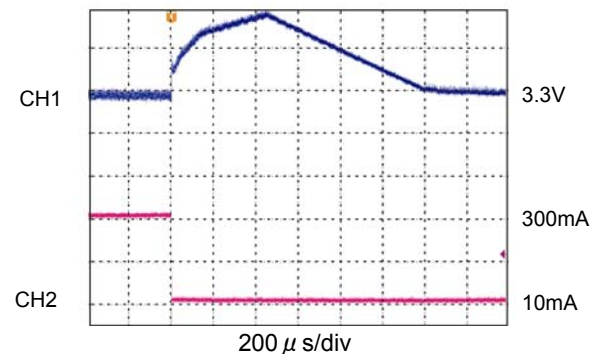

CH1:  $V_{OUT1}$ , AC-COUPLED, 50mV/div  
 CH2:  $I_{OUT1}$ , 150mA/div



## ■ TYPICAL PERFORMANCE CHARACTERISTICS (Continued)

< 1 ch. Step-Up DC/DC Controller > (Continued)

(25) Load Transient Response (Continued)

<  $V_{OUT1} = 0.9V$ ,  $V_{IN} = 3.3V$ ,  $I_{OUT1} = 100\mu A \leftrightarrow 300mA$  >

### ● PWM Control

$f_{osc}=300kHz$ ,  $V_{OUT1} = 0.9V$   
 $V_{IN}=3.3V$ ,  $I_{OUT1} = 100\mu A \rightarrow 300mA$

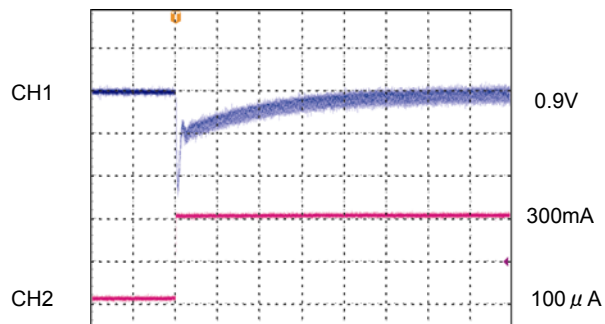

200  $\mu$  s/div

CH1:  $V_{OUT1}$ , AC-COUPLED, 20mV/div

CH2:  $I_{OUT1}$ , 150mA/div

$f_{osc}=300kHz$ ,  $V_{OUT1} = 0.9V$   
 $V_{IN}=3.3V$ ,  $I_{OUT1} = 300mA \rightarrow 100\mu A$

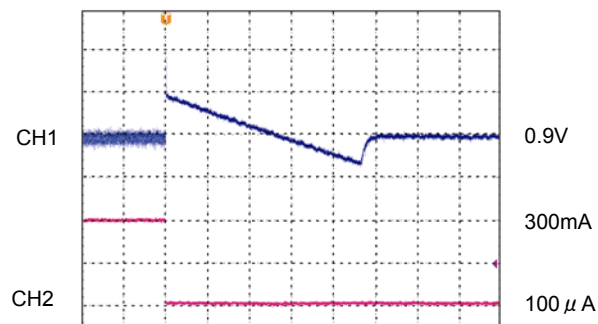

4ms/div

CH1:  $V_{OUT1}$ , AC-COUPLED, 20mV/div

CH2:  $I_{OUT1}$ , 150mA/div

### ● PWM/PFM Switching Control

$f_{osc}=300kHz$ ,  $V_{OUT1} = 0.9V$   
 $V_{IN}=3.3V$ ,  $I_{OUT1} = 100\mu A \rightarrow 300mA$

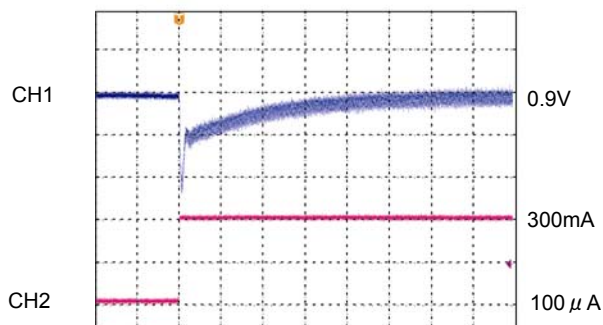

200  $\mu$  s/div

CH1:  $V_{OUT1}$ , AC-COUPLED, 20mV/div

CH2:  $I_{OUT1}$ , 150mA/div

$f_{osc}=300kHz$ ,  $V_{OUT1} = 0.9V$   
 $V_{IN}=3.3V$ ,  $I_{OUT1} = 300mA \rightarrow 100\mu A$

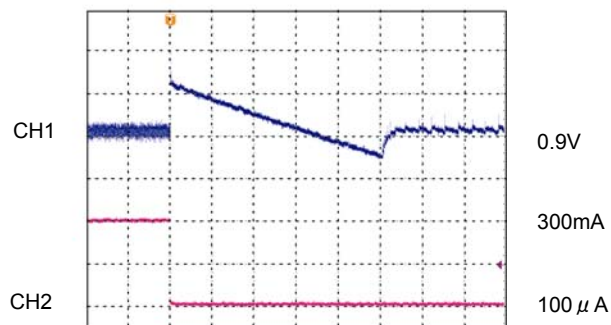

4ms/div

CH1:  $V_{OUT1}$ , AC-COUPLED, 20mV/div

CH2:  $I_{OUT1}$ , 150mA/div

## TYPICAL PERFORMANCE CHARACTERISTICS (Continued)

< 1 ch. Step-Up DC/DC Controller > (Continued)

(25) Load Transient Response (Continued)

<  $V_{OUT1} = 0.9V$ ,  $V_{IN} = 3.3V$ ,  $I_{OUT1} = 10mA \leftrightarrow 300mA$  >

### ● PWM Control

$f_{OSC} = 300kHz$ ,  $V_{OUT1} = 0.9V$   
 $V_{IN} = 3.3V$ ,  $I_{OUT1} = 10mA \rightarrow 300mA$

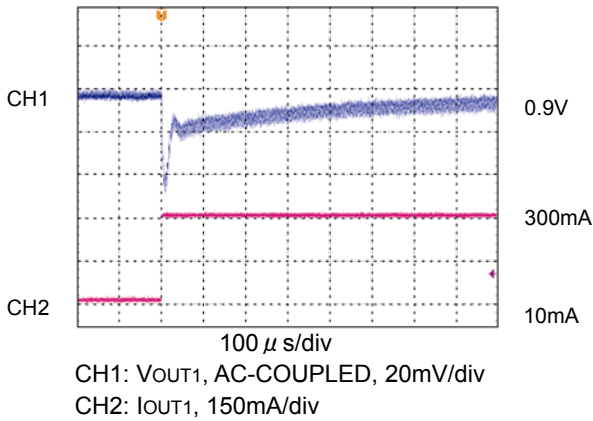

$f_{OSC} = 300kHz$ ,  $V_{OUT1} = 0.9V$   
 $V_{IN} = 3.3V$ ,  $I_{OUT1} = 300mA \rightarrow 10mA$

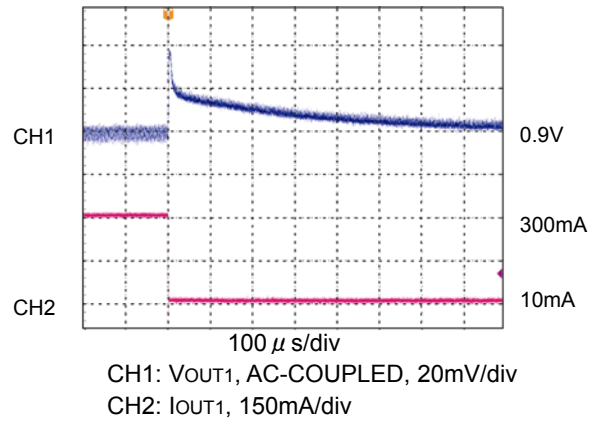

### ● PWM/PFM Switching Control

$f_{OSC} = 300kHz$ ,  $V_{OUT1} = 0.9V$   
 $V_{IN} = 3.3V$ ,  $I_{OUT1} = 10mA \rightarrow 300mA$

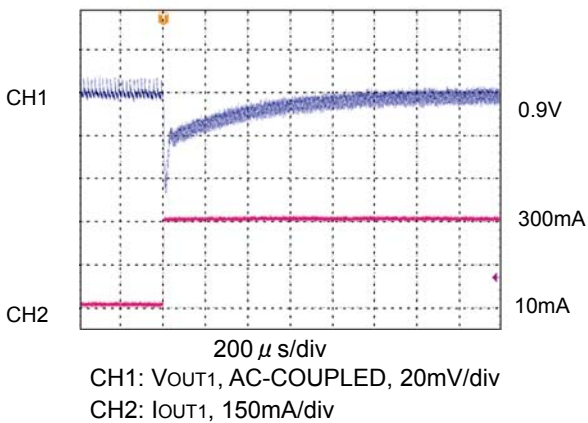

$f_{OSC} = 300kHz$ ,  $V_{OUT1} = 0.9V$   
 $V_{IN} = 3.3V$ ,  $I_{OUT1} = 300mA \rightarrow 10mA$

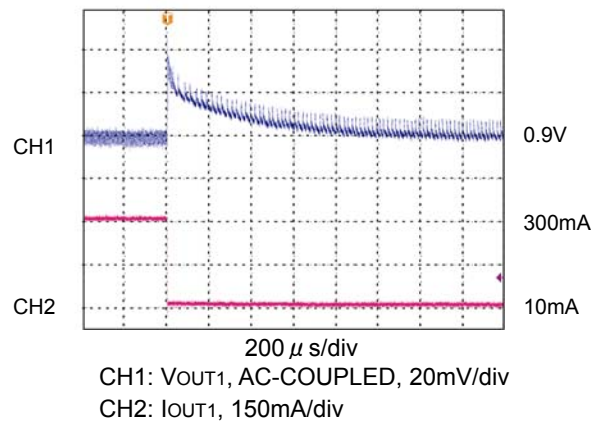

## ■ TYPICAL PERFORMANCE CHARACTERISTICS (Continued)

< 1 ch. Step-Up DC/DC Controller > (Continued)

(25) Load Transient Response (Continued)

< PWM Control ⇔ PWM / PFM Switching Control >

$f_{osc}=300kHz$ ,  $V_{OUT1}=3.3V$   
 $V_{IN}=5.0V$ ,  $I_{OUT1}=5mA$ , PWM1 'L'→'H'

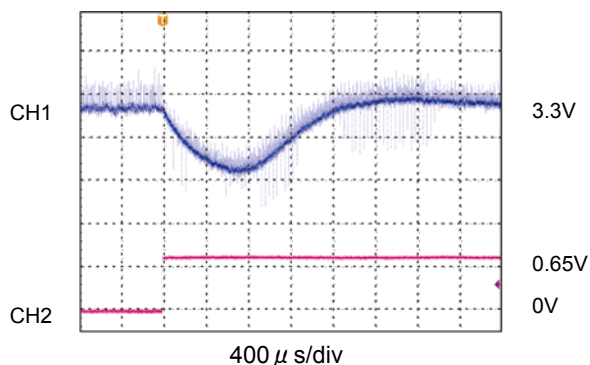

CH1:  $V_{OUT1}$ , AC-COUPLED, 10mV/div  
CH2: PWM1, 0.5V/div

$f_{osc}=300kHz$ ,  $V_{OUT1}=3.3V$   
 $V_{IN}=5.0V$ ,  $I_{OUT1}=5A$ , PWM1 'H'→'L'

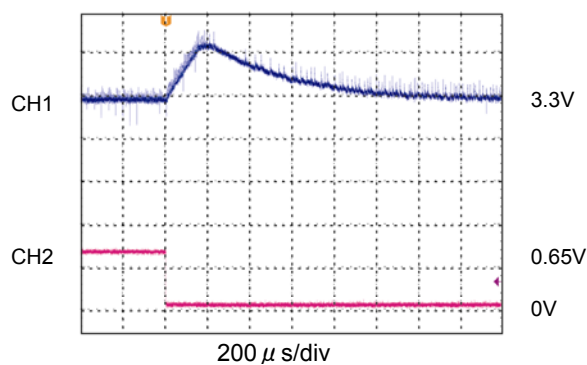

CH1:  $V_{OUT1}$ , AC-COUPLED, 20mV/div  
CH2: PWM1, 0.5V/div

< Soft-Start Wave Form >

$f_{osc}=300kHz$ ,  $V_{OUT1}=3.3V$   
 $V_{IN}=5.0V$ ,  $I_{OUT1}=300mA$   
N1 'L'→'H',  $C_{IN}=47\mu F$

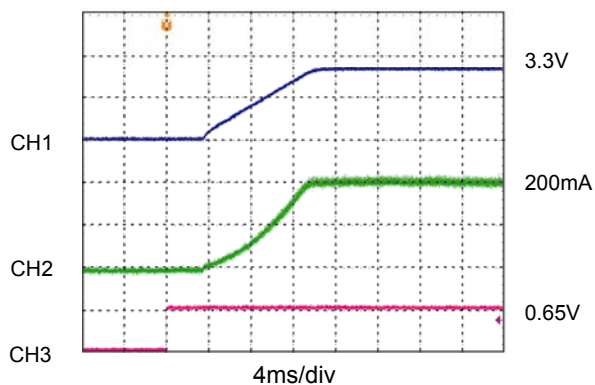

CH1:  $V_{OUT1}$ , 2.0V/div  
CH2:  $I_{IN1}$ , 100mA/div  
CH3: EN1, 0.5V/div

$f_{osc}=300kHz$ ,  $V_{OUT1}=3.3V$   
 $V_{IN}=5.0V$ ,  $I_{OUT1}=100mA$   
EN1 'L'→'H',  $C_{IN}=47\mu F$

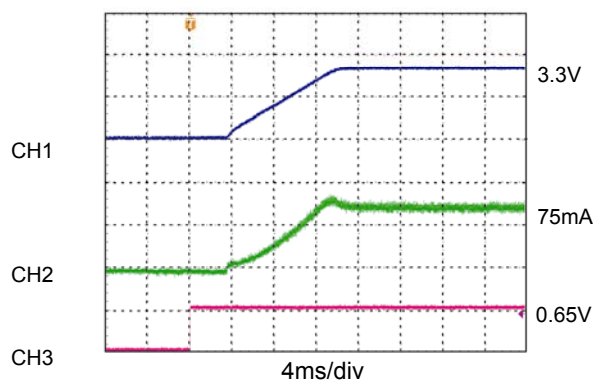

CH1:  $V_{OUT1}$ , 2.0V/div  
CH2:  $I_{IN1}$ , 50mA/div  
CH3: EN1, 0.5V/div

\* EN2=GND

## TYPICAL PERFORMANCE CHARACTERISTICS (Continued)

< 2 ch. Inverting DC/DC Controller >

(25) Load Transient Response (Continued)

<  $V_{OUT2} = -7.5V$ ,  $V_{IN} = 3.3V$ ,  $I_{OUT2} = -100\mu A \leftrightarrow -50mA$  >

(Tantalum capacitor use)

### ● PWM Control

$f_{OSC} = 180kHz$ ,  $V_{OUT2} = -7.5V$   
 $V_{IN} = 3.3V$ ,  $I_{OUT2} = 100\mu A \rightarrow -50mA$

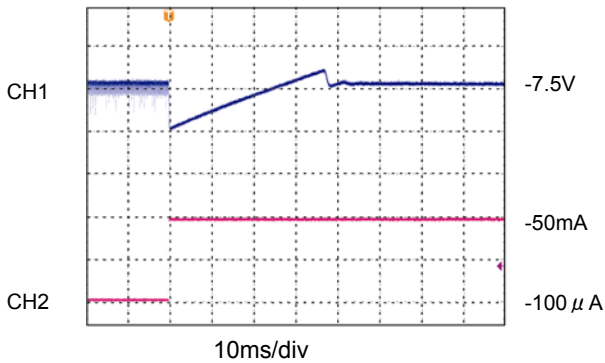

CH1:  $V_{OUT2}$ , AC-COUPLED, 50mV/div  
 CH2:  $I_{OUT2}$ , 50mA/div

$f_{OSC} = 180kHz$ ,  $V_{OUT2} = -7.5V$   
 $V_{IN} = 3.3V$ ,  $I_{OUT2} = -50mA \rightarrow -100\mu A$

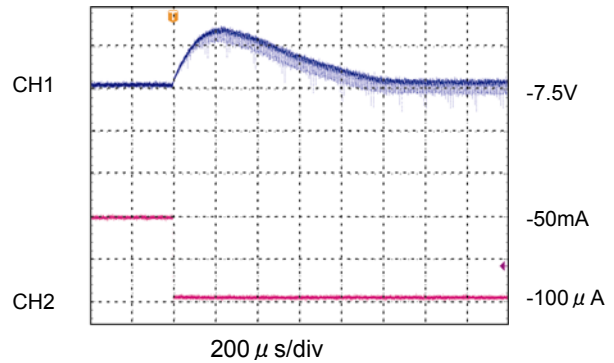

CH1:  $V_{OUT2}$ , AC-COUPLED, 50mV/div  
 CH2:  $I_{OUT2}$ , 50mA/div

### ● PWM/PFM Switching Control

$f_{OSC} = 180kHz$ ,  $V_{OUT2} = -7.5V$   
 $V_{IN} = 3.3V$ ,  $I_{OUT2} = -100\mu A \rightarrow -50mA$

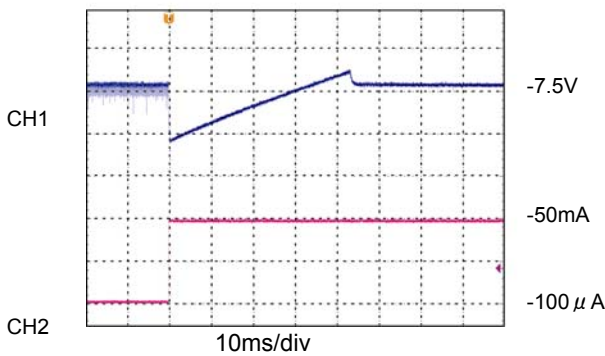

CH1:  $V_{OUT2}$ , AC-COUPLED, 50mV/div  
 CH2:  $I_{OUT2}$ , 50mA/div

$f_{OSC} = 180kHz$ ,  $V_{OUT2} = -7.5V$   
 $V_{IN} = 3.3V$ ,  $I_{OUT2} = -50mA \rightarrow -100\mu A$

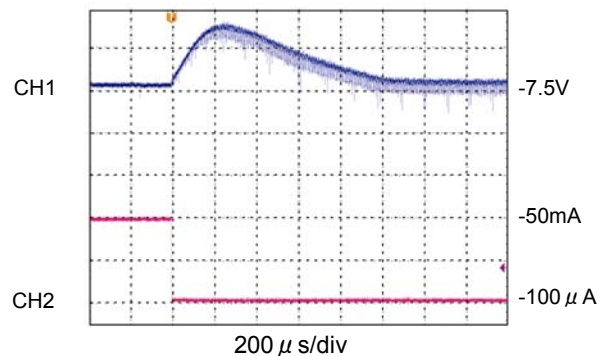

CH1:  $V_{OUT2}$ , AC-COUPLED, 50mV/div  
 CH2:  $I_{OUT2}$ , 50mA/div

## ■ TYPICAL PERFORMANCE CHARACTERISTICS (Continued)

< 2 ch. Inverting DC/DC Controller > (Continued)

(25) Load Transient Response (Continued)

<  $V_{OUT2} = -7.5V$ ,  $V_{IN} = 3.3V$ ,  $I_{OUT2} = -100\mu A \leftrightarrow -20mA$  > (Ceramic capacitor use when coil current is discontinued.)

### ● PWM Control

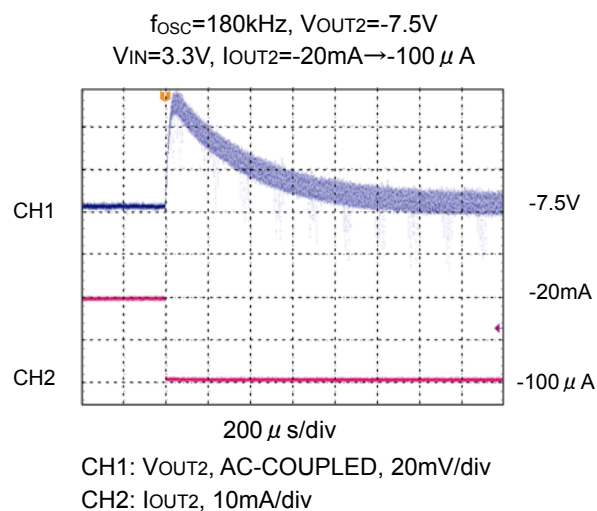
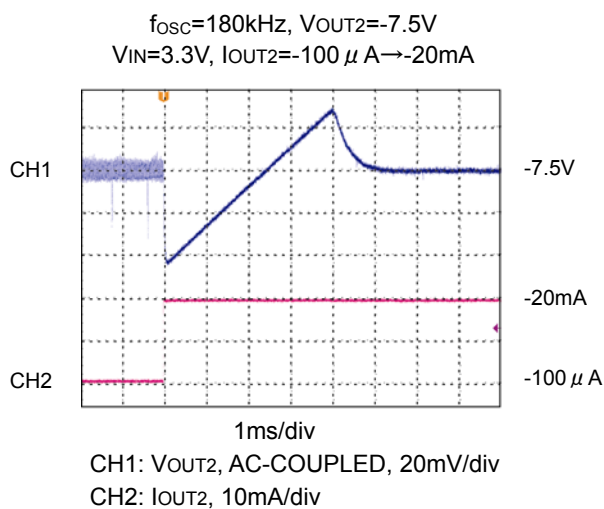

### ● PWM/PFM Switching Control

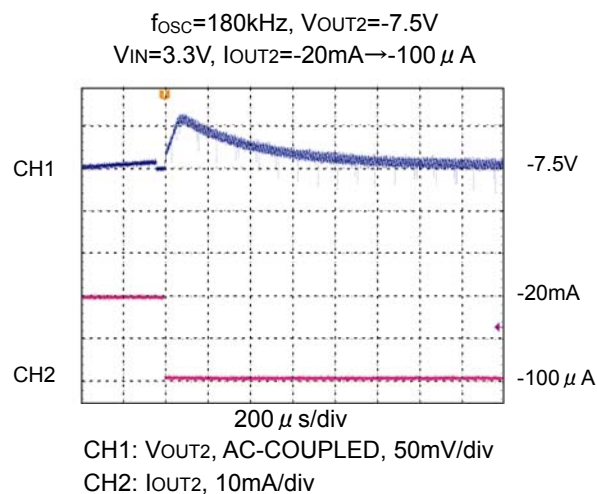
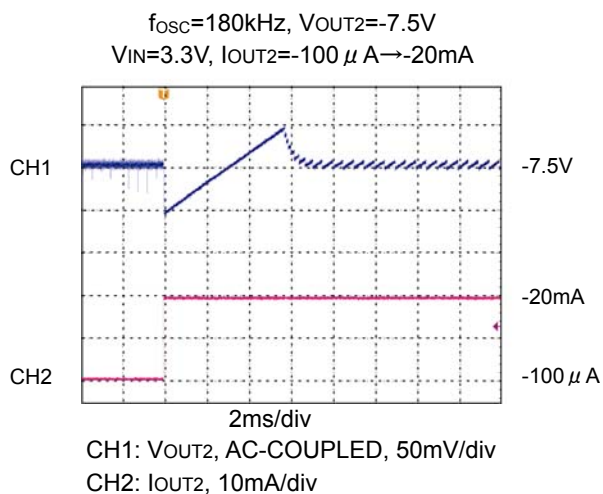

## TYPICAL PERFORMANCE CHARACTERISTICS (Continued)

< 2 ch. Inverting DC/DC Controller > (Continued)  
 (25) Load Transient Response (Continued)

<  $V_{OUT2} = -7.5V$ ,  $V_{IN} = 3.3V$ ,  $I_{OUT2} = -1mA \leftrightarrow -20mA$  >

### PWM Control

$f_{OSC}=180kHz$ ,  $V_{OUT2}=-7.5V$   
 $V_{IN}=3.3V$ ,  $I_{OUT2}=-1mA \rightarrow -20mA$

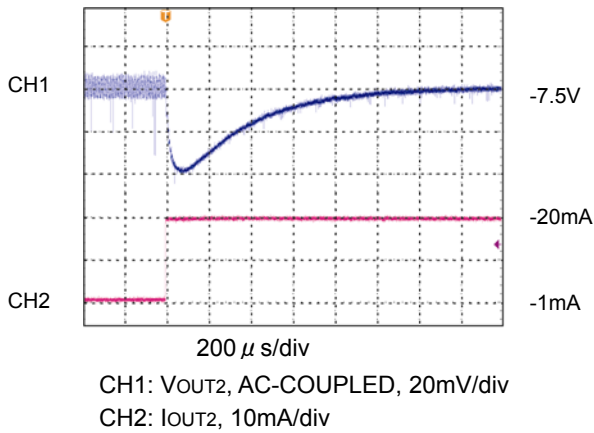

$f_{OSC}=180kHz$ ,  $V_{OUT2}=-7.5V$   
 $V_{IN}=3.3V$ ,  $I_{OUT2}=-20mA \rightarrow -1mA$

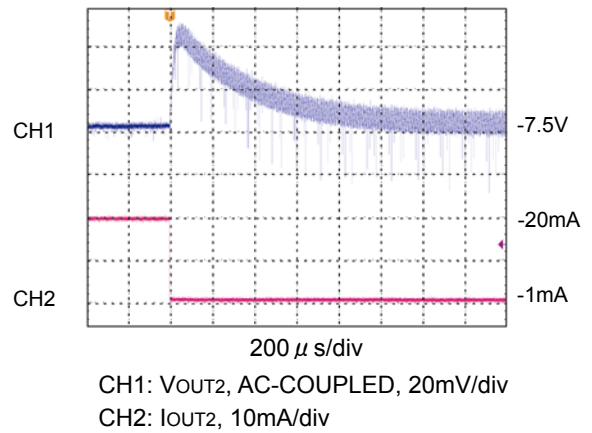

### PWM/PFM Switching Control

$f_{OSC}=180kHz$ ,  $V_{OUT2}=-7.5V$   
 $V_{IN}=3.3V$ ,  $I_{OUT2}=-1mA \rightarrow -20mA$

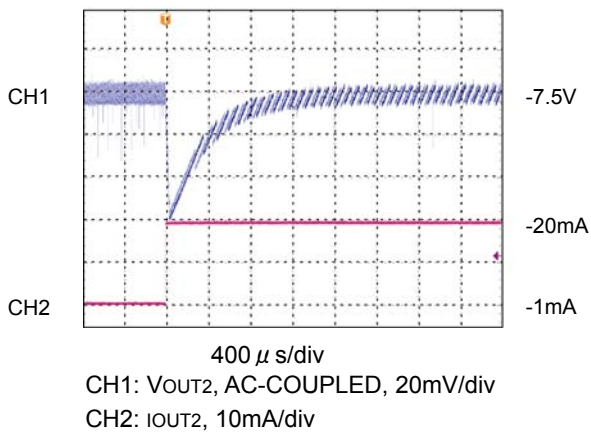

$f_{OSC}=180kHz$ ,  $V_{OUT2}=-7.5V$   
 $V_{IN}=3.3V$ ,  $I_{OUT2}=-20mA \rightarrow -1mA$

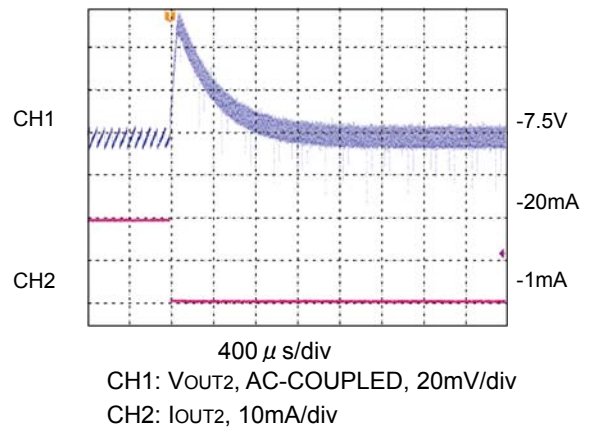



## ■ TYPICAL PERFORMANCE CHARACTERISTICS (Continued)

< 2 ch. Inverting DC/DC Controller > (Continued)

(25) Load Transient Response (Continued)

< PWM Control ↔ PWM / PFM Switching Control >

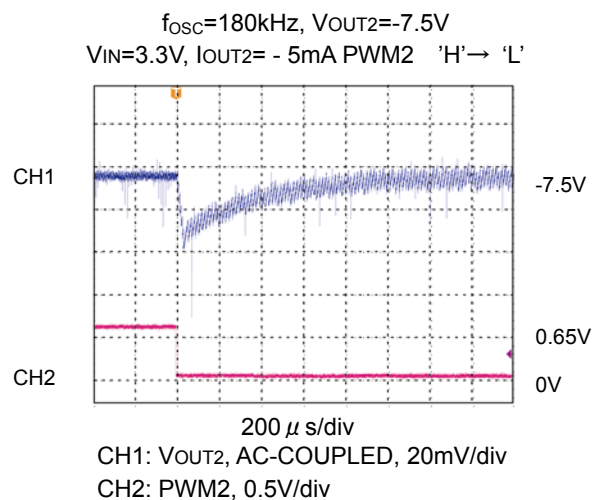
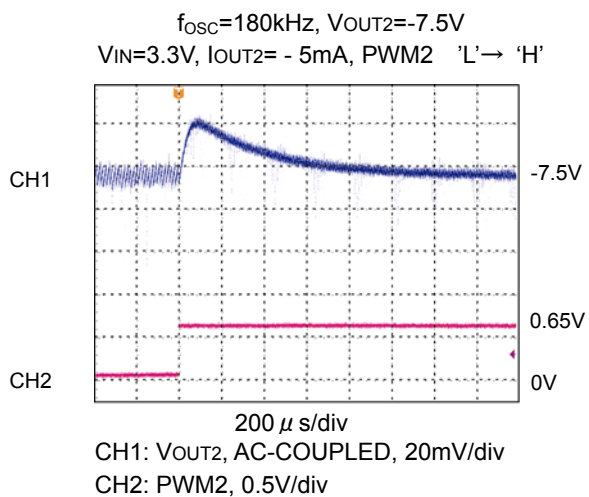

## PACKAGING INFORMATION

### ● MSOP-10

Unit:mm

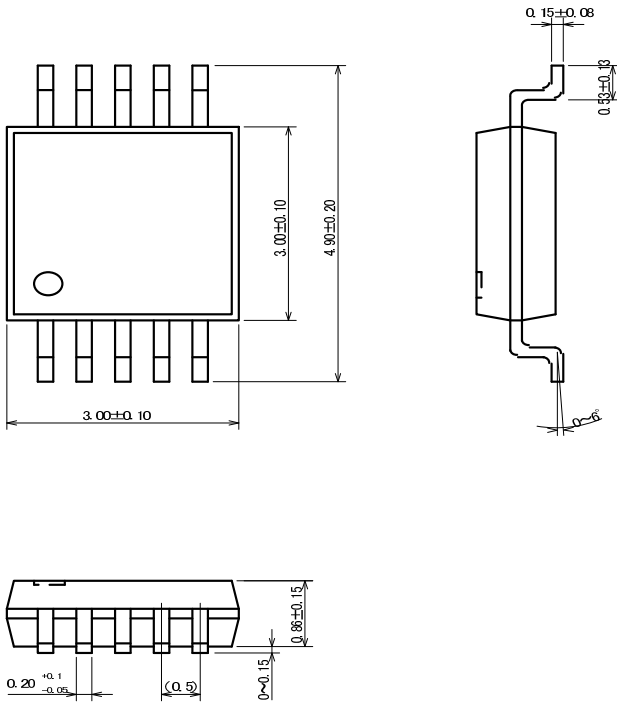

### ● USP-10

Unit:mm

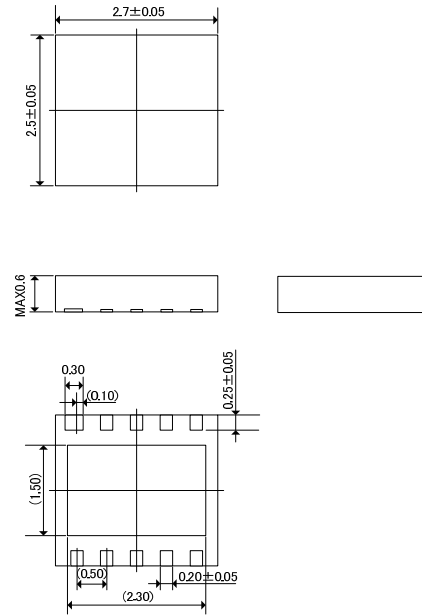

### ● USP-10 Reference Pattern Layout

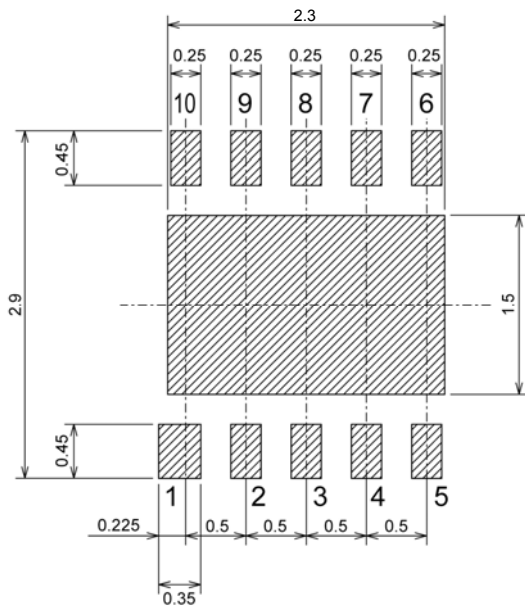

### ● USP-10 Reference Metal Mask Design

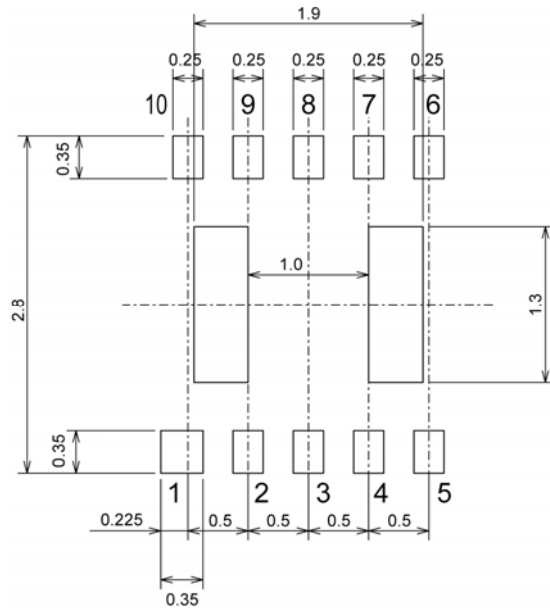



## MARKING RULE

### ●MSOP-10, USP-10

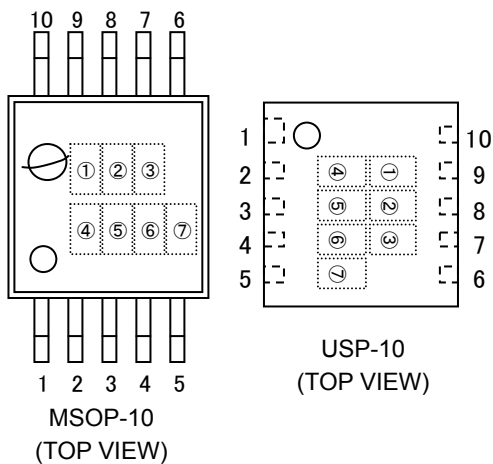

① represents product series

| MARK | PRODUCT SERIES |
|------|----------------|
| 5    | XC9505B09xxx   |

② represents type of DC/DC controller

| MARK | TYPE     | PRODUCT SERIES |
|------|----------|----------------|
| B    | Standard | XC9505B09xxx   |

③,④ represents FB voltage

| MARK |   | VOLTAGE (V) | PRODUCT SERIES |
|------|---|-------------|----------------|
| ③    | ④ |             |                |
| 0    | 9 | 0.9         | XC9505B09xxx   |

⑤ represents oscillation frequency

| MARK | OSCILLATION FREQUENCY (kHz) | PRODUCT SERIES |
|------|-----------------------------|----------------|
| 2    | 180                         | XC9505B092xx   |
| 3    | 300                         | XC9505B093xx   |
| 5    | 500                         | XC9505B095xx   |

⑥,⑦ represents production lot number

00, 01, to 09, 0A to 0Z, 19, 1A, repeated (G, I, J, O, Q, W excluded)

Note: No character inversion used.

| MARK |   | PRODUCT ROT |
|------|---|-------------|
| ⑥    | ⑦ |             |
| 0    | 3 | 03          |
| 1    | A | 1A          |