

XC9801/XC9802 Series

ETR0804-006

Regulated Voltage Step-Up Charge Pump ICs

■ GENERAL DESCRIPTION

The XC9801 series are fixed regulated voltage step-up charge pump ICs which provide stable, highly efficient, positive voltages with the only external components required being 2 capacitors.

Since regulating is done via the control of the charge pump's gate voltage waveform, ripple is minimal. Output voltage is selectable in 100mV steps within a 2.5V ~ 6.0V range.

Control of the XC9802 switches to PFM (pulse skip) during light loads without affecting output impedance or ripple so that the IC is protected against drops in efficiency. Connecting the SENSE pin to the GND pin allows the IC to be used as a voltage doubler.

As well as the ultra small MSOP-8A and USP-8 and USP-8B05 packages, the small consumption current and high efficiencies of the series make the XC9801 suitable for use with all types of battery operated applications.

■ APPLICATIONS

- Power supplies for TFT
- Power supplies for Opamp
- Smart card
- On board local power supplies
- Various battery powered devices

■ FEATURES

- Input Voltage Range** : 1.8V ~ 5.5V
- Output Voltage Range** : 2.5V ~ 6.0V
- Small Input Current** : 80 μ A (no load:XC9802)
- Output Current** : 80mA (3.6V→5.0V step-up)
- Oscillation Frequency** : 300 kHz
- Stand-by Current (CE 'L')** : 2.0 μ A (MAX.)
- PFM Operation During Light Loads (XC9802)**
- CE (Chip Enable) Function**
- Can be used as a step-up doubler (sense = 0V)**
- Packages** : MSOP-8A, USP-8, USP-8B05
- Environmentally Friendly** : EU RoHS Compliant, Pb Free

■ TYPICAL APPLICATION CIRCUIT

Regulation Output

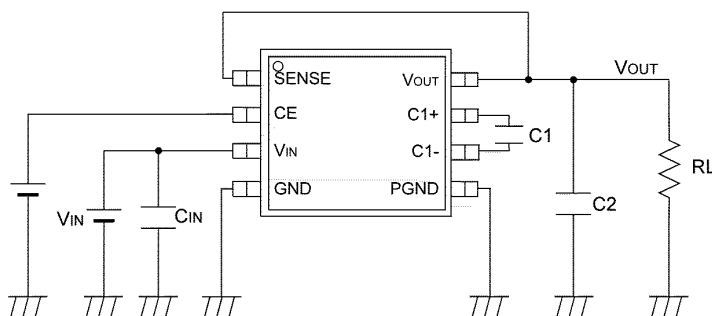

■ TYPICAL PERFORMANCE CHARACTERISTICS

XC9802B503KR(300kHz,5.0V)

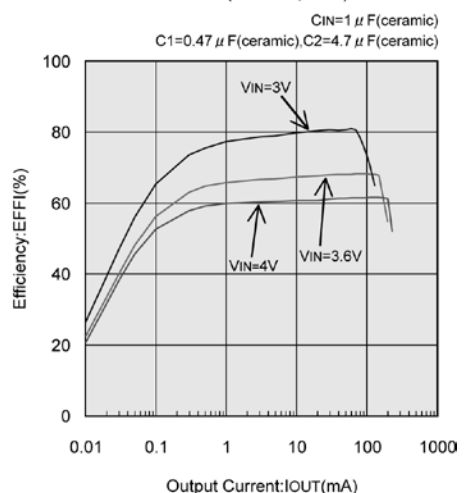

■ BLOCK DIAGRAM

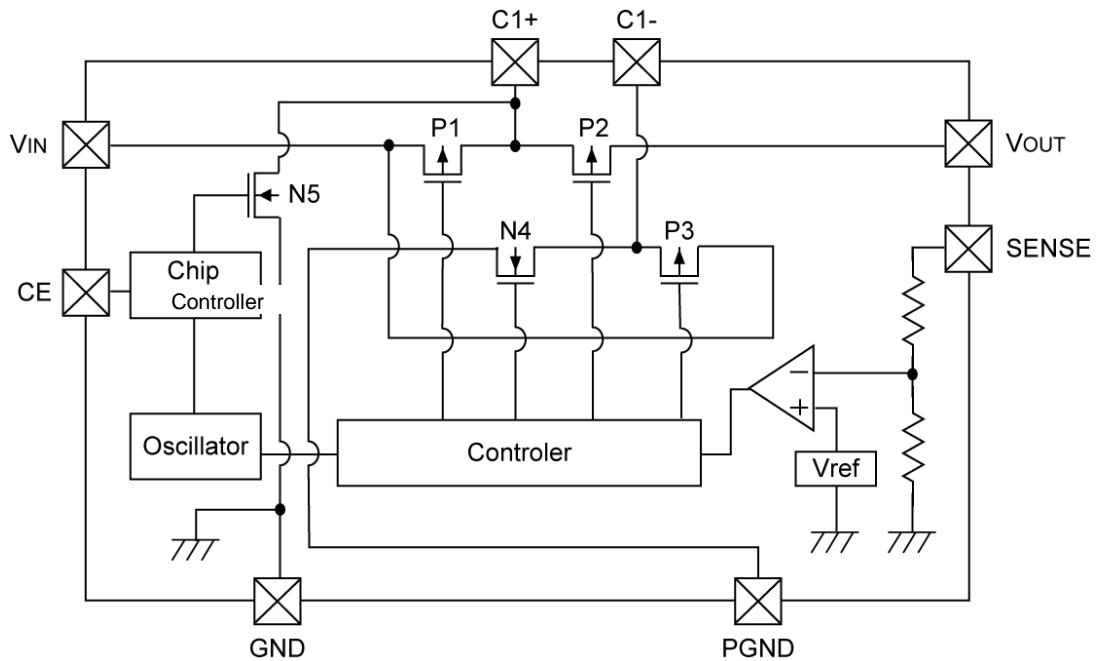

■ PRODUCT CLASSIFICATION

● Ordering Information

XC9801/XC9802 ①②③④⑤⑥-⑦^(*)

| DESIGNATOR | ITEM | SYMBOL | DESCRIPTION |
|------------|----------------------------|---------|---|
| ① | True Logic Level at CE Pin | B | Positive |
| ②③ | Output Voltage | 50 | Standard voltage $V_{OUT}=5.0V \rightarrow$ ②=5, ③=0 |
| | | 25 ~ 60 | Semi-custom voltage e.g. $V_{OUT}=2.5V \rightarrow$ ②=2, ③=5 |
| ④ | Oscillation Frequency | 3 | 300kHz |
| ⑤⑥-⑦ | Packages (Order Unit) | KR | MSOP-8A (1,000pcs/Reel) |
| | | KR-G | MSOP-8A (1,000pcs/Reel) |
| | | DR | USP-8 (3,000pcs/Reel) |
| | | DR-G | USP-8 (3,000pcs/Reel) |
| | | ER-G | USP-8B05 (5,000pcs/Reel) |

Regulated output voltage function cannot be used by the following input voltage condition:

$$V_{IN} < (V_{OUT}/2), \text{ or } V_{IN} \geq V_{OUT}$$

(*1) The "-G" suffix denotes Halogen and Antimony free as well as being fully EU RoHS compliant.

● Selection Guide

| SERIES | PULSE SKIP MODE |
|--------|-----------------|
| XC9801 | Not Available |
| XC9802 | Available |

■ PIN CONFIGURATION

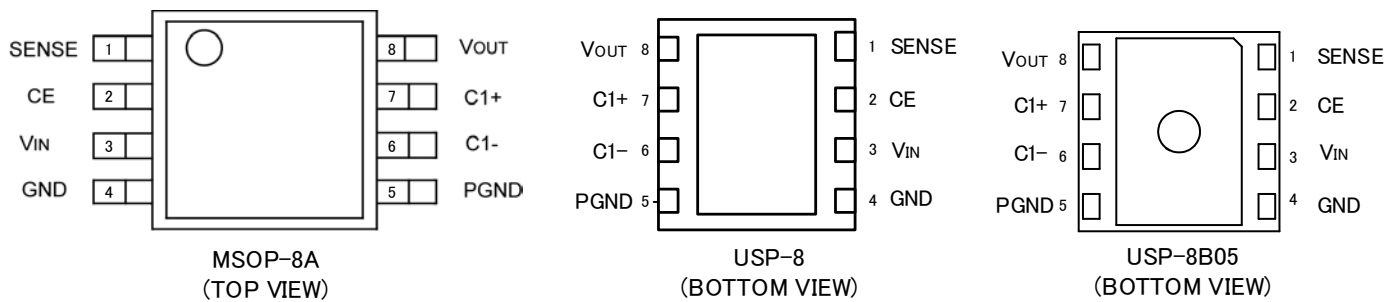

* The dissipation pad for the USP-8 and USP-8B05 package should be solder-plated in recommended mount pattern and metal masking so as to enhance mounting strength and heat release.
If the pad needs to be connected to other pins, it should be connected to the GND (No. 4, 5) pin.

■ PIN ASSIGNMENT

| PIN NUMBER | | | PIN NAME | FUNCTION |
|------------|---------|----------|----------|---------------------------|
| USP-8 | MSOP-8A | USP-8B05 | | |
| 1 | 1 | 1 | SENSE | Output Voltage Monitor |
| 2 | 2 | 2 | CE | Chip Enable (High Active) |
| 3 | 3 | 3 | VIN | Input (Power Supply) |
| 4 | 4 | 4 | GND | Ground |
| 5 | 5 | 5 | PGND | Power Ground |
| 6 | 6 | 6 | C1- | External Capacitor - Pin |
| 7 | 7 | 7 | C1+ | External Capacitor + Pin |
| 8 | 8 | 8 | VOUT | Output |

■ FUNCTION

| PIN NAME | SIGNAL | STATUS |
|----------|--------|----------|
| CE | H | Active |
| | L | Stand-by |

* Please do not leave the CE pin open

ABSOLUTE MAXIMUM RATINGS

| PARAMETER | SYMBOL | CONDITIONS | UNITS | |
|-------------------------------------|--|----------------------------|-------|----|
| V _{IN} pin Voltage | V _{IN} | -0.3~6.0 | V | |
| V _{OUT} pin Voltage | V _{OUT} | -0.3~12.0 | V | |
| C1 + pin Voltage | C1+ | -0.3~V _{OUT} +0.3 | V | |
| C1 - pin Voltage | C1- | -0.3~V _{OUT} +0.3 | V | |
| CE pin Voltage | VCE | -0.3~V _{IN} +0.3 | V | |
| SENSE pin Voltage | VSENSE | -0.3~12.0 | V | |
| V _{OUT} Pin Output Current | I _{OUT} | 200 | mA | |
| Power Dissipation | MSOP-8A | Pd | 150 | mW |
| | USP-8 | | 120 | |
| | 1200 (40mm x 40mm Standard board) ^(*) | | | |
| | USP-8B05 | | 120 | |
| Operating Temperature Range | Topr | -40~+85 | °C | |
| Storage Temperature Range | Tstg | -40~+125 | °C | |

^(*) The power dissipation figure shown is PCB mounted and is for reference only.
The mounting condition is please refer to PACKAGING INFORMATION.

ELECTRICAL CHARACTERISTICS

XC9801Bxx3K V_{OUT}=*.*V

T_a=25°C

| PARAMETER | SYMBOL | CONDITIONS | | MIN. | TYP. | MAX. | UNITS | CIRCUIT |
|--|-------------------|--|------------------------|------|------|------|-------|---------|
| Output Voltage | V _{OUT} | Regulation Output | I _{OUT} =1mA | ① | ② | ③ | V | 3 |
| Load Regulation | ΔV _{OUT} | Regulation Output | ⑨ | ⑤ | - | ⑥ | mV | 3 |
| Operating Voltage Range | V _{IN} | Doubler Output, V _{OUT} >V _{IN} × 2 × 0.95 | | 1.8 | - | 5.5 | V | 4 |
| Supply Current | I _{DD} | V _{IN} =3.6V, External Components=CIN only, SENSE=0V, V _{OUT} =V _{IN} | | 1 | 3 | 6 | mA | 1 |
| Stand-by Current | I _{STB} | CE=0V | | - | - | 2.0 | μA | 3 |
| Oscillation Frequency | FOSC | External Component=CIN only, SENSE=0V, V _{OUT} open | | 255 | 300 | 345 | kHz | 2 |
| Output Impedance ^(*) | ROUT | Doubler Output, V _{IN} =3.6V | I _{OUT} =10mA | - | 20 | 40 | Ω | 4 |
| No Load Input Current | I _{IN} | Doubler Output, V _{IN} =3.6V | | - | 5 | - | mA | 4 |
| | I _{IN2} | Regulation Output | | - | ⑦ | - | mA | 3 |
| Voltage Converting Efficiency ^(*) | VEFF1 | Doubler Output, V _{IN} =3.6V | | 95 | 99 | - | % | 4 |
| Power Converting Efficiency | EFF1 | Doubler Output, V _{IN} =3.6V | I _{OUT} =10mA | 73 | 78 | - | % | 4 |
| | EFF12 | Regulation Output | I _{OUT} =1mA | - | ⑧ | - | % | 3 |
| | EFF13 | | ⑨ | 64 | 69 | - | % | 3 |
| CE / 'H' Level Voltage | V _{CEH} | | | 1.5 | - | - | V | 3 |
| CE / 'L' Level Voltage | V _{CEL} | | | - | - | 0.25 | V | 3 |
| CE / Input Current | I _{CE} | V _{IN} =5.5V, SENSE=0V, External Components=CIN only | | -2.0 | - | 2.0 | μA | 5 |

Test Conditions: Unless otherwise stated, Typical Application Circuit, V_{IN}=Setting Voltage × 0.72V,
GND=0V, CE=V_{IN}, No Load, SENSE=V_{OUT} (Regulation Output)

■ ELECTRICAL CHARACTERISTICS(Continued)

XC9802Bxx3K $V_{OUT} = * . * V$

$T_a = 25^\circ C$

| PARAMETER | SYMBOL | CONDITIONS | | MIN. | TYP. | MAX. | UNITS | CIRCUIT |
|--|------------------|--|----------------|------|------|------|----------|---------|
| Output Voltage | V_{OUT} | Regulation Output | $I_{OUT}=1mA$ | ① | ② | ③ | V | 3 |
| Load Regulation | ΔV_{OUT} | Regulation Output | ④ | ⑤ | - | ⑥ | mV | 3 |
| Operating Voltage Range | V_{IN} | Doubler Output, $V_{OUT} > V_{IN} \times 2 \times 0.95$ | | 1.8 | - | 5.5 | V | 4 |
| Supply Current | I_{DD} | $V_{IN}=3.6V$, External Components=CIN only, SENSE=0V, $V_{OUT}=V_{IN}$ | | 1 | 3 | 6 | mA | 1 |
| Stand-by Current | I_{STB} | CE=0V | | - | - | 2.0 | μA | 3 |
| Oscillation Frequency | FOSC | External Component = CIN only, SENSE=0V, V_{OUT} open | | 255 | 300 | 345 | kHz | 2 |
| Switching Pulse Frequency | FOSC2 | Regulation Output | $I_{OUT}=1mA$ | - | 10 | - | kHz | 3 |
| Output Impedance ⁽¹⁾ | R_{OUT} | Doubler Output, $V_{IN}=3.6V$ | $I_{OUT}=10mA$ | - | 20 | 40 | Ω | 4 |
| No Load Input Current | I_{IN} | Doubler Output, $V_{IN}=3.6V$ | | - | 5 | - | mA | 3 |
| | I_{IN2} | Regulation Output | | - | ⑦ | - | mA | 4 |
| Voltage Converting Efficiency ⁽²⁾ | VEFF1 | Doubler Output, $V_{IN}=3.6V$ | | 98 | 99 | - | % | 4 |
| Power Converting Efficiency | EFF1 | Doubler Output, $V_{IN}=3.6V$ | $I_{OUT}=10mA$ | 73 | 78 | - | % | 4 |
| | EFFI2 | Regulation Output | $I_{OUT}=1mA$ | - | ⑧ | - | % | 3 |
| | EFFI3 | | ④ | 64 | 69 | - | % | 3 |
| CE / 'H' Level Voltage | V_{CEH} | | | 1.5 | - | - | V | 3 |
| CE / 'L' Level Voltage | V_{CEL} | | | - | - | 0.25 | V | 3 |
| CE / Input Current | I_{CE} | $V_{IN}=5.5V$, SENSE=0V, External Components=CIN only | | -2.0 | - | 2.0 | μA | 5 |

Test Conditions: Unless otherwise stated, Typical Application Circuit, $V_{IN} = \text{Setting Voltage} \times 0.72V$, GND=0V, CE= V_{IN} , No Load, SENSE= V_{OUT} (Regulation Output)

⁽¹⁾ Output Impedance Calculation formula

$$R_{OUT} = \frac{V_{OUT1} - V_{OUT2}}{I_{OUT}}$$

V_{OUT1} ($I_{OUT}=0mA$ Output Current)
 V_{OUT2} ($I_{OUT}=10mA$ Output Current)
 $I_{OUT}=10mA$

⁽²⁾ Voltage Converting Efficiency Calculation formula

$$EFFI = \frac{V_{OUT} \times I_{OUT}}{V_{IN} \times I_{IN}} \times 100$$

V_{IN} (Input Voltage)
 I_{IN} (Input Current)
 V_{OUT} ($I_{OUT}=**mA$ Output Voltage)
 I_{OUT} (Output Current)

■ ELECTRICAL CHARACTERISTICS (Continued)

XC9801series SPEC

| Nominal Detect [V] | SYMBOL | | | | | | | | |
|--------------------|------------------|------|-------|-------------------|------------|--------------------------------|---------------|-----------------------------|-------------------------|
| | ① | ② | ③ | ⑤ | ⑥ | ④ | ⑦ | ⑧ | ⑨ |
| | Output Voltage | | | Load Regulation | | | Input Current | Power Converting Efficiency | |
| | V _{OUT} | | | ΔV _{OUT} | | | IIN2 | EFF2 | EFF3 |
| MIN. | TYP. | MAX. | MIN. | MAX. | conditions | TYP. | TYP. | conditions | |
| 2.5 | 2.438 | 2.5 | 2.563 | -50 | 50 | 1mA ≤ I _{OUT} ≤ 10mA | 1.0 | 52 | I _{OUT} =10mA |
| 2.6 | 2.535 | 2.6 | 2.665 | -52 | 52 | 1mA ≤ I _{OUT} ≤ 13mA | 1.0 | 52 | I _{OUT} =13mA |
| 2.7 | 2.633 | 2.7 | 2.768 | -54 | 54 | 1mA ≤ I _{OUT} ≤ 16mA | 1.0 | 51 | I _{OUT} =16mA |
| 2.8 | 2.730 | 2.8 | 2.870 | -56 | 56 | 1mA ≤ I _{OUT} ≤ 18mA | 1.1 | 51 | I _{OUT} =18mA |
| 2.9 | 2.828 | 2.9 | 2.973 | -58 | 58 | 1mA ≤ I _{OUT} ≤ 21mA | 1.1 | 50 | I _{OUT} =21mA |
| 3.0 | 2.925 | 3.0 | 3.075 | -60 | 60 | 1mA ≤ I _{OUT} ≤ 24mA | 1.1 | 50 | I _{OUT} =24mA |
| 3.1 | 3.023 | 3.1 | 3.178 | -62 | 62 | 1mA ≤ I _{OUT} ≤ 27mA | 1.1 | 49 | I _{OUT} =27mA |
| 3.2 | 3.120 | 3.2 | 3.280 | -64 | 64 | 1mA ≤ I _{OUT} ≤ 30mA | 1.1 | 49 | I _{OUT} =30mA |
| 3.3 | 3.218 | 3.3 | 3.383 | -66 | 66 | 1mA ≤ I _{OUT} ≤ 32mA | 1.1 | 48 | I _{OUT} =32mA |
| 3.4 | 3.315 | 3.4 | 3.485 | -68 | 68 | 1mA ≤ I _{OUT} ≤ 35mA | 1.2 | 48 | I _{OUT} =35mA |
| 3.5 | 3.413 | 3.5 | 3.588 | -70 | 70 | 1mA ≤ I _{OUT} ≤ 38mA | 1.2 | 47 | I _{OUT} =38mA |
| 3.6 | 3.510 | 3.6 | 3.690 | -72 | 72 | 1mA ≤ I _{OUT} ≤ 41mA | 1.2 | 47 | I _{OUT} =41mA |
| 3.7 | 3.608 | 3.7 | 3.793 | -74 | 74 | 1mA ≤ I _{OUT} ≤ 44mA | 1.2 | 46 | I _{OUT} =44mA |
| 3.8 | 3.705 | 3.8 | 3.895 | -76 | 76 | 1mA ≤ I _{OUT} ≤ 46mA | 1.2 | 46 | I _{OUT} =46mA |
| 3.9 | 3.803 | 3.9 | 3.998 | -78 | 78 | 1mA ≤ I _{OUT} ≤ 49mA | 1.3 | 45 | I _{OUT} =49mA |
| 4.0 | 3.900 | 4.0 | 4.100 | -80 | 80 | 1mA ≤ I _{OUT} ≤ 52mA | 1.3 | 45 | I _{OUT} =52mA |
| 4.1 | 3.998 | 4.1 | 4.203 | -82 | 82 | 1mA ≤ I _{OUT} ≤ 55mA | 1.3 | 44 | I _{OUT} =55mA |
| 4.2 | 4.095 | 4.2 | 4.305 | -84 | 84 | 1mA ≤ I _{OUT} ≤ 58mA | 1.3 | 44 | I _{OUT} =58mA |
| 4.3 | 4.193 | 4.3 | 4.408 | -86 | 86 | 1mA ≤ I _{OUT} ≤ 60mA | 1.3 | 43 | I _{OUT} =60mA |
| 4.4 | 4.290 | 4.4 | 4.510 | -88 | 88 | 1mA ≤ I _{OUT} ≤ 63mA | 1.3 | 43 | I _{OUT} =63mA |
| 4.5 | 4.388 | 4.5 | 4.613 | -90 | 90 | 1mA ≤ I _{OUT} ≤ 66mA | 1.4 | 42 | I _{OUT} =66mA |
| 4.6 | 4.485 | 4.6 | 4.715 | -92 | 92 | 1mA ≤ I _{OUT} ≤ 69mA | 1.4 | 42 | I _{OUT} =69mA |
| 4.7 | 4.583 | 4.7 | 4.818 | -94 | 94 | 1mA ≤ I _{OUT} ≤ 72mA | 1.4 | 41 | I _{OUT} =72mA |
| 4.8 | 4.680 | 4.8 | 4.920 | -96 | 96 | 1mA ≤ I _{OUT} ≤ 74mA | 1.4 | 41 | I _{OUT} =74mA |
| 4.9 | 4.778 | 4.9 | 5.023 | -98 | 98 | 1mA ≤ I _{OUT} ≤ 77mA | 1.5 | 40 | I _{OUT} =77mA |
| 5.0 | 4.875 | 5.0 | 5.125 | -100 | 100 | 1mA ≤ I _{OUT} ≤ 80mA | 1.5 | 40 | I _{OUT} =80mA |
| 5.1 | 4.973 | 5.1 | 5.228 | -102 | 102 | 1mA ≤ I _{OUT} ≤ 83mA | 1.5 | 39 | I _{OUT} =83mA |
| 5.2 | 5.070 | 5.2 | 5.330 | -104 | 104 | 1mA ≤ I _{OUT} ≤ 86mA | 1.5 | 39 | I _{OUT} =86mA |
| 5.3 | 5.168 | 5.3 | 5.433 | -106 | 106 | 1mA ≤ I _{OUT} ≤ 89mA | 1.6 | 38 | I _{OUT} =89mA |
| 5.4 | 5.265 | 5.4 | 5.535 | -108 | 108 | 1mA ≤ I _{OUT} ≤ 91mA | 1.6 | 38 | I _{OUT} =91mA |
| 5.5 | 5.363 | 5.5 | 5.638 | -110 | 110 | 1mA ≤ I _{OUT} ≤ 94mA | 1.6 | 37 | I _{OUT} =94mA |
| 5.6 | 5.460 | 5.6 | 5.740 | -112 | 112 | 1mA ≤ I _{OUT} ≤ 97mA | 1.6 | 37 | I _{OUT} =97mA |
| 5.7 | 5.558 | 5.7 | 5.843 | -114 | 114 | 1mA ≤ I _{OUT} ≤ 100mA | 1.7 | 36 | I _{OUT} =100mA |
| 5.8 | 5.655 | 5.8 | 5.945 | -116 | 116 | 1mA ≤ I _{OUT} ≤ 102mA | 1.7 | 36 | I _{OUT} =102mA |
| 5.9 | 5.753 | 5.9 | 6.048 | -118 | 118 | 1mA ≤ I _{OUT} ≤ 105mA | 1.7 | 35 | I _{OUT} =105mA |
| 6.0 | 5.850 | 6.0 | 6.150 | -120 | 120 | 1mA ≤ I _{OUT} ≤ 108mA | 1.7 | 35 | I _{OUT} =108mA |

■ ELECTRICAL CHARACTERISTICS (Continued)

XC9802 series SPEC

| Nominal Detect [V] | SYMBOL | | | | | | | | |
|--------------------|------------------|------|-------|-------------------|------------|--------------------------------|------------------|-----------------------------|-------------------------|
| | ① | ② | ③ | ⑤ | ⑥ | ④ | ⑦ | ⑧ | ⑨ |
| | Output Voltage | | | Load Regulation | | | Input Current | Power Converting Efficiency | |
| | V _{OUT} | | | ΔV _{OUT} | | | I _{IN2} | EFF2 | EFF3 |
| MIN. | TYP. | MAX. | MIN. | MAX. | conditions | TYP. | TYP. | conditions | |
| 2.5 | 2.438 | 2.5 | 2.563 | -50 | 50 | 1mA ≤ I _{OUT} ≤ 10mA | 0.08 | 65 | I _{OUT} =10mA |
| 2.6 | 2.535 | 2.6 | 2.665 | -52 | 52 | 1mA ≤ I _{OUT} ≤ 13mA | 0.08 | 65 | I _{OUT} =13mA |
| 2.7 | 2.633 | 2.7 | 2.768 | -54 | 54 | 1mA ≤ I _{OUT} ≤ 16mA | 0.08 | 65 | I _{OUT} =16mA |
| 2.8 | 2.730 | 2.8 | 2.870 | -56 | 56 | 1mA ≤ I _{OUT} ≤ 18mA | 0.08 | 65 | I _{OUT} =18mA |
| 2.9 | 2.828 | 2.9 | 2.973 | -58 | 58 | 1mA ≤ I _{OUT} ≤ 21mA | 0.08 | 64 | I _{OUT} =21mA |
| 3.0 | 2.925 | 3.0 | 3.075 | -60 | 60 | 1mA ≤ I _{OUT} ≤ 24mA | 0.08 | 64 | I _{OUT} =24mA |
| 3.1 | 3.023 | 3.1 | 3.178 | -62 | 62 | 1mA ≤ I _{OUT} ≤ 27mA | 0.08 | 64 | I _{OUT} =27mA |
| 3.2 | 3.120 | 3.2 | 3.280 | -64 | 64 | 1mA ≤ I _{OUT} ≤ 30mA | 0.08 | 64 | I _{OUT} =30mA |
| 3.3 | 3.218 | 3.3 | 3.383 | -66 | 66 | 1mA ≤ I _{OUT} ≤ 32mA | 0.08 | 63 | I _{OUT} =32mA |
| 3.4 | 3.315 | 3.4 | 3.485 | -68 | 68 | 1mA ≤ I _{OUT} ≤ 35mA | 0.08 | 63 | I _{OUT} =35mA |
| 3.5 | 3.413 | 3.5 | 3.588 | -70 | 70 | 1mA ≤ I _{OUT} ≤ 38mA | 0.08 | 63 | I _{OUT} =38mA |
| 3.6 | 3.510 | 3.6 | 3.690 | -72 | 72 | 1mA ≤ I _{OUT} ≤ 41mA | 0.08 | 63 | I _{OUT} =41mA |
| 3.7 | 3.608 | 3.7 | 3.793 | -74 | 74 | 1mA ≤ I _{OUT} ≤ 44mA | 0.08 | 62 | I _{OUT} =44mA |
| 3.8 | 3.705 | 3.8 | 3.895 | -76 | 76 | 1mA ≤ I _{OUT} ≤ 46mA | 0.08 | 62 | I _{OUT} =46mA |
| 3.9 | 3.803 | 3.9 | 3.998 | -78 | 78 | 1mA ≤ I _{OUT} ≤ 49mA | 0.08 | 62 | I _{OUT} =49mA |
| 4.0 | 3.900 | 4.0 | 4.100 | -80 | 80 | 1mA ≤ I _{OUT} ≤ 52mA | 0.08 | 62 | I _{OUT} =52mA |
| 4.1 | 3.998 | 4.1 | 4.203 | -82 | 82 | 1mA ≤ I _{OUT} ≤ 55mA | 0.08 | 61 | I _{OUT} =55mA |
| 4.2 | 4.095 | 4.2 | 4.305 | -84 | 84 | 1mA ≤ I _{OUT} ≤ 58mA | 0.08 | 61 | I _{OUT} =58mA |
| 4.3 | 4.193 | 4.3 | 4.408 | -86 | 86 | 1mA ≤ I _{OUT} ≤ 60mA | 0.08 | 61 | I _{OUT} =60mA |
| 4.4 | 4.290 | 4.4 | 4.510 | -88 | 88 | 1mA ≤ I _{OUT} ≤ 63mA | 0.08 | 61 | I _{OUT} =63mA |
| 4.5 | 4.388 | 4.5 | 4.613 | -90 | 90 | 1mA ≤ I _{OUT} ≤ 66mA | 0.08 | 60 | I _{OUT} =66mA |
| 4.6 | 4.485 | 4.6 | 4.715 | -92 | 92 | 1mA ≤ I _{OUT} ≤ 69mA | 0.08 | 60 | I _{OUT} =69mA |
| 4.7 | 4.583 | 4.7 | 4.818 | -94 | 94 | 1mA ≤ I _{OUT} ≤ 72mA | 0.08 | 60 | I _{OUT} =72mA |
| 4.8 | 4.680 | 4.8 | 4.920 | -96 | 96 | 1mA ≤ I _{OUT} ≤ 74mA | 0.08 | 60 | I _{OUT} =74mA |
| 4.9 | 4.778 | 4.9 | 5.023 | -98 | 98 | 1mA ≤ I _{OUT} ≤ 77mA | 0.08 | 60 | I _{OUT} =77mA |
| 5.0 | 4.875 | 5.0 | 5.125 | -100 | 100 | 1mA ≤ I _{OUT} ≤ 80mA | 0.08 | 59 | I _{OUT} =80mA |
| 5.1 | 4.973 | 5.1 | 5.228 | -102 | 102 | 1mA ≤ I _{OUT} ≤ 83mA | 0.08 | 59 | I _{OUT} =83mA |
| 5.2 | 5.070 | 5.2 | 5.330 | -104 | 104 | 1mA ≤ I _{OUT} ≤ 86mA | 0.08 | 59 | I _{OUT} =86mA |
| 5.3 | 5.168 | 5.3 | 5.433 | -106 | 106 | 1mA ≤ I _{OUT} ≤ 89mA | 0.08 | 58 | I _{OUT} =89mA |
| 5.4 | 5.265 | 5.4 | 5.535 | -108 | 108 | 1mA ≤ I _{OUT} ≤ 91mA | 0.08 | 58 | I _{OUT} =91mA |
| 5.5 | 5.363 | 5.5 | 5.638 | -110 | 110 | 1mA ≤ I _{OUT} ≤ 94mA | 0.08 | 58 | I _{OUT} =94mA |
| 5.6 | 5.460 | 5.6 | 5.740 | -112 | 112 | 1mA ≤ I _{OUT} ≤ 97mA | 0.08 | 58 | I _{OUT} =97mA |
| 5.7 | 5.558 | 5.7 | 5.843 | -114 | 114 | 1mA ≤ I _{OUT} ≤ 100mA | 0.08 | 57 | I _{OUT} =100mA |
| 5.8 | 5.655 | 5.8 | 5.945 | -116 | 116 | 1mA ≤ I _{OUT} ≤ 102mA | 0.08 | 57 | I _{OUT} =102mA |
| 5.9 | 5.753 | 5.9 | 6.048 | -118 | 118 | 1mA ≤ I _{OUT} ≤ 105mA | 0.08 | 57 | I _{OUT} =105mA |
| 6.0 | 5.850 | 6.0 | 6.150 | -120 | 120 | 1mA ≤ I _{OUT} ≤ 108mA | 0.08 | 57 | I _{OUT} =108mA |

TYPICAL CIRCUITS

CIRCUIT①

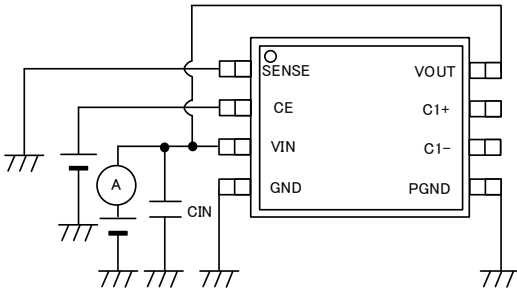

CIRCUIT②

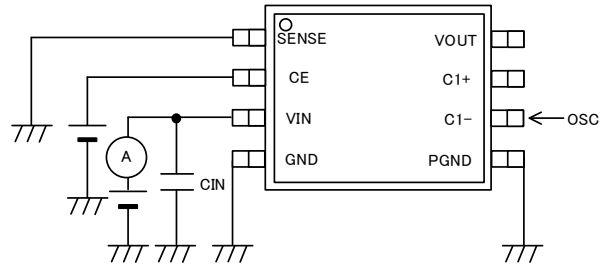

CIRCUIT③

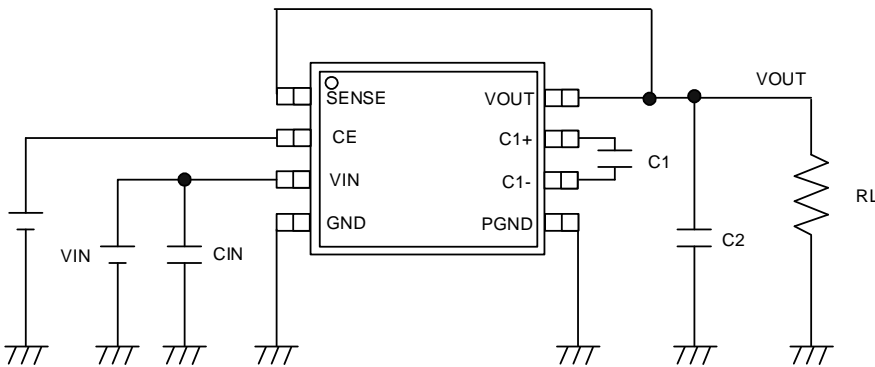

[External parts]

CIN=1uF

C1=0.47uF

C2=4.7uF

CIRCUIT④

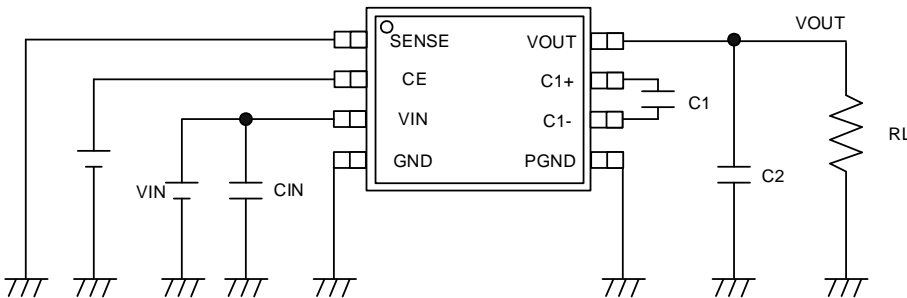

[External parts]

CIN=1uF

C1=0.47uF

C2=4.7uF

CIRCUIT⑤

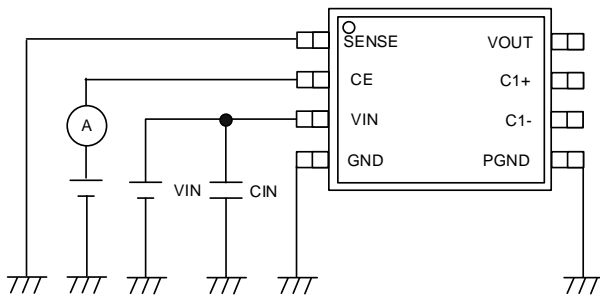

TYPICAL APPLICATION CIRCUITS

① Regulation Output

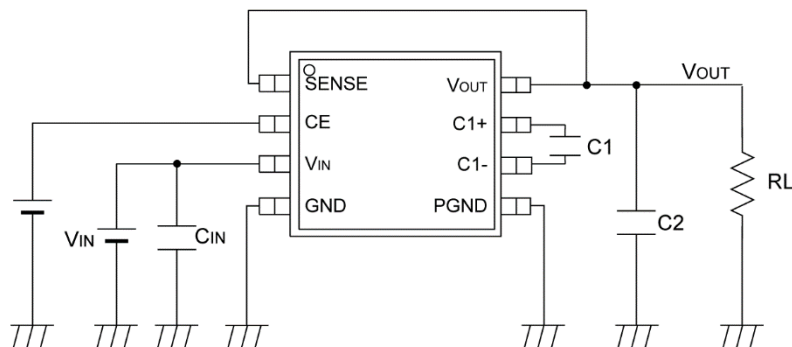

② Doubler Output

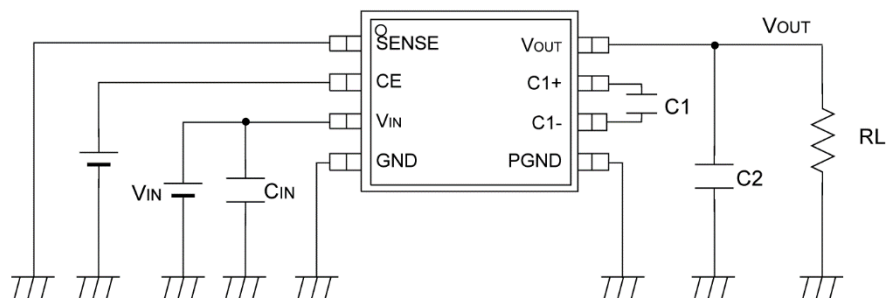

【Typical Examples】

| | MANUFACTURER | PRODUCT NUMBER | VALUE | SIZE(L×W×T) |
|-----|--------------|-------------------|-----------------------|------------------|
| CIN | TAIYO YUDEN | LMK107BJ105KA | 1μF/10V | 1.6×0.8×0.8(mm) |
| | Murata | GRM033R61A225KE47 | 2.2μF/10V | 0.6×0.3×0.33(mm) |
| C1 | TAIYO YUDEN | LMK107BJ474KA | 0.47μF/10V | 1.6×0.8×0.8(mm) |
| | Murata | GRM033R61A105ME15 | 1μF/10V | 0.6×0.3×0.33(mm) |
| C2 | TAIYO YUDEN | LMK107BJ475KA | 4.7μF/10V | 1.6×0.8×0.8(mm) |
| | Murata | GRM153R60J475ME15 | 4.7μF/6.3V, 2parallel | 1.0×0.5×0.33(mm) |

Note: The XC9801 series are step-up charge pump voltage doublers which provide regulated output voltage.

The application circuit of the doubler output (②) halts the regulated output function and operates as a normal voltage doubler.

The output voltage is stable when connected as in (①) above, except when $V_{IN} < (V_{OUT} / 2)$ and $V_{IN} \geq V_{OUT}$.

■ OPERATIONAL EXPLANATION

(1) Basic Operations

Using the XC9801/02's clock generated by the internal oscillator, a step-up charge pump operation can be brought about as a result of the alternate switching between operating conditions where P1 & N4 are ON with P2 & P3 OFF (or) P1 & N4 are OFF with P2 & P3 ON. By connecting the SENSE pin to V_{OUT} , output voltage can be feedback and the difference between the feedback voltage and the reference voltage (V_{ref}) are compared by the internal operational amplifier. Output voltage can be stabilized (* 2) by controlling P3's gate voltage waveform via the signal generated by the internal amplifier.

Please note that this stabilizing function will not operate with $V_{IN} < (V_{OUT}/2)$ or $V_{IN} \geq V_{OUT}$.

By connecting SENSE to ground, the output stability function, as described above, can be halted and the IC can be used as a step-up doubler.

* 2: As a result of P3 gradually reaching an ON state with each clock (signal), rush current is controlled, the ripple decreases and with the combination of the independent phase compensation circuit, output voltage is stabilized

(2) Stand-by

When the voltage at CE (chip enable) is 'low' (0V), P1, P2 & P3 will be OFF with N4 & N5 ON. The external capacitor C1 will discharge and impedance at V_{OUT} will be high.

(3) PFM (Pulse Skip) Operations

Whilst maintaining output voltage, the XC9802 provides the added security of protection against drops in efficiency during light loads as a result of the pulse, generated by the internal oscillator, being skipped and the operating frequency being changed.

■ NOTE ON USE

1. For the phenomenon of temporal and transitional voltage decrease or voltage increase, the IC may be damaged or deteriorated if IC is used beyond the absolute MAX specifications.
2. When using a capacitor, please select one with low ESR, Equivalent Series Resistance, like ceramic capacitors. And please use a ceramic capacitor with B-characteristics of which static capacitance decreases less. Otherwise, the characteristics of the IC can significantly decrease.
3. However, please bear in mind that the output stabilization function cannot be used under the condition of $V_{IN} < (V_{OUT}/2)$ or $V_{IN} \geq V_{OUT}$.
4. Torex places an importance on improving our products and their reliability. We request that users incorporate fail-safe designs and post-aging protection treatment when using Torex products in their systems.

TYPICAL PERFORMANCE CHARACTERISTICS

● XC9801B333KR (300kHz, 3.3V)

(1) Output Voltage vs. Output Current

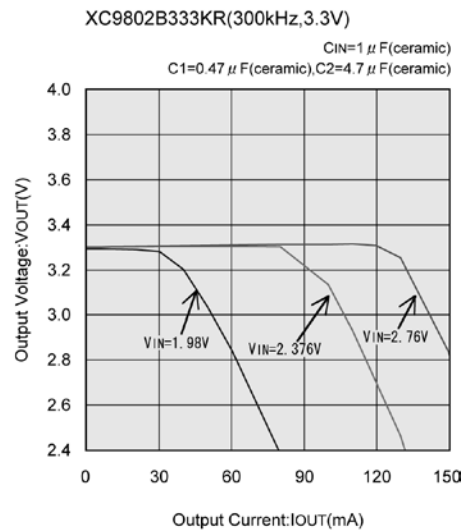
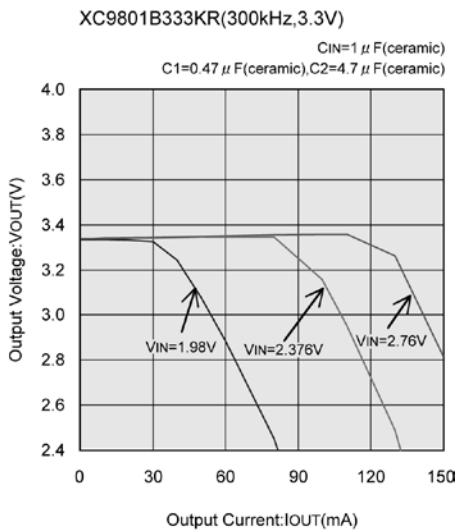

(2) Efficiency vs. Output Current

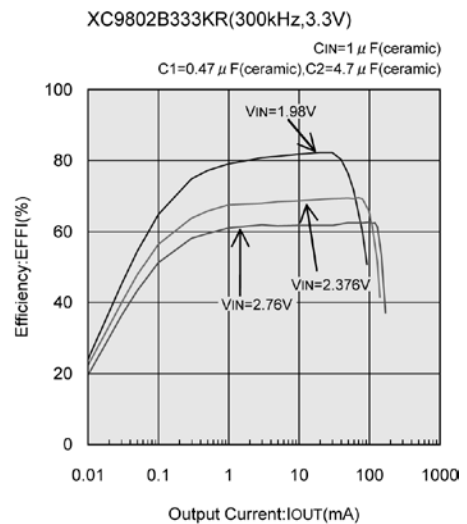
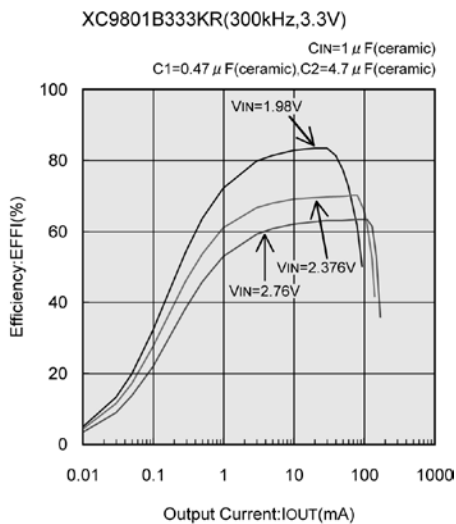

(3) Ripple Voltage vs. Output Current

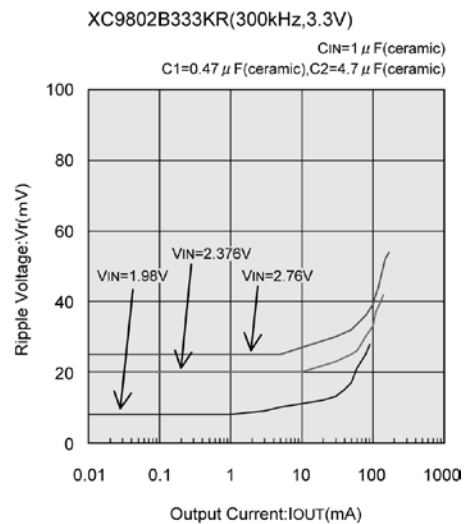
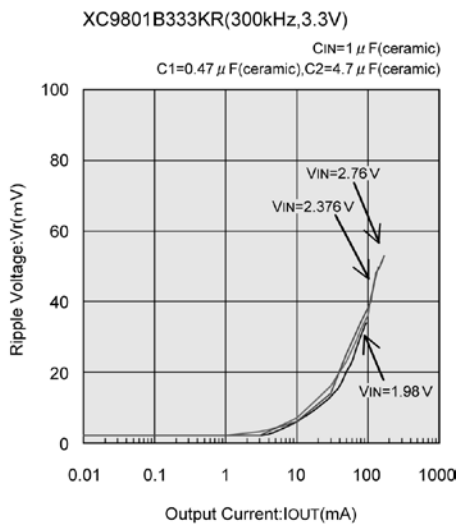

■ TYPICAL PERFORMANCE CHARACTERISTICS (Continued)

● XC9801B503KR (300kHz, 5.0V)

(1) Output Voltage vs. Output Current

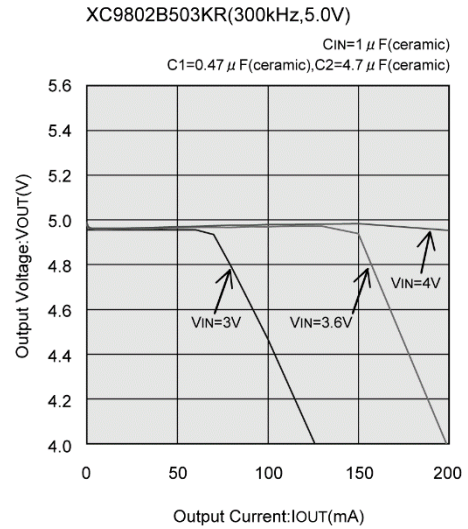
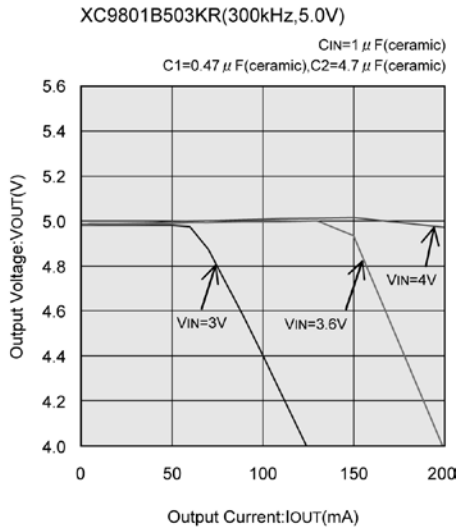

(2) Efficiency vs. Output Current

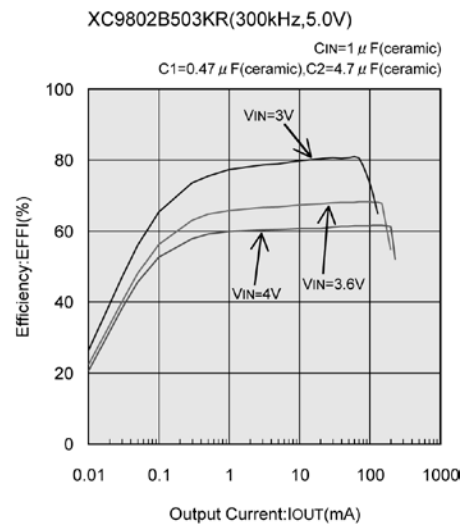
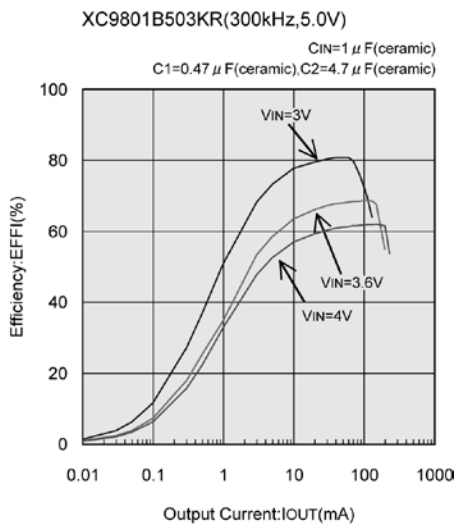

(3) Ripple Voltage vs. Output Current

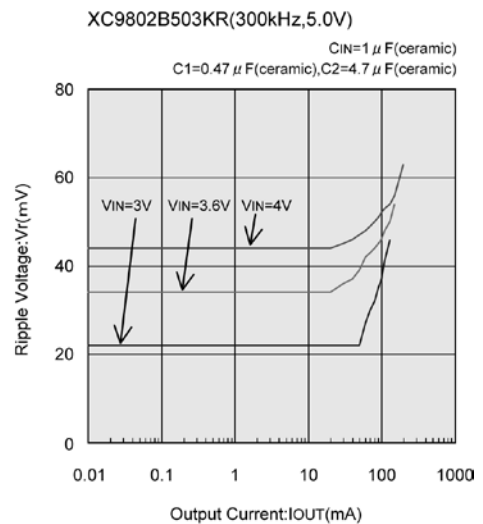
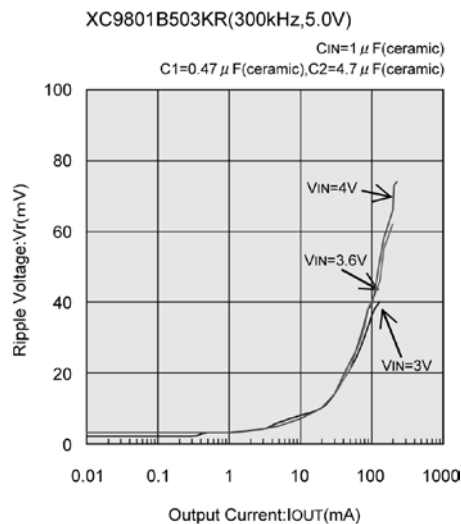

TYPICAL PERFORMANCE CHARACTERISTICS (Continued)

XC9801B503KR (300kHz, SENSE=0V, Doubler)

(1) Output Voltage vs. Output Current

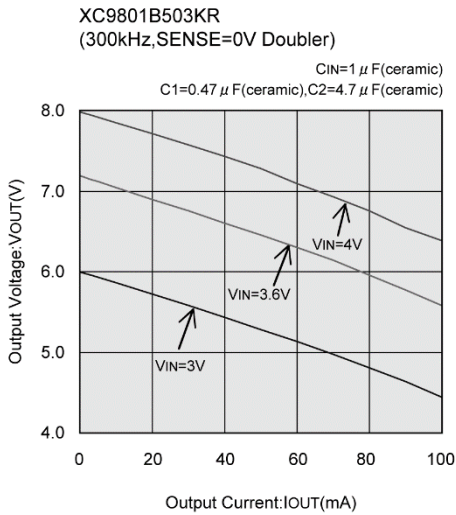

(2) Efficiency vs. Output Current

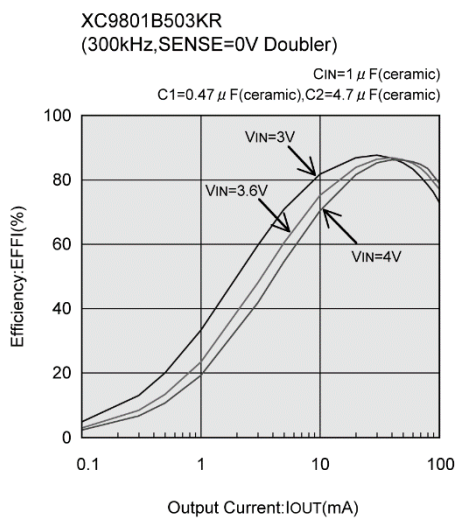

(3) Ripple Voltage vs. Output Current

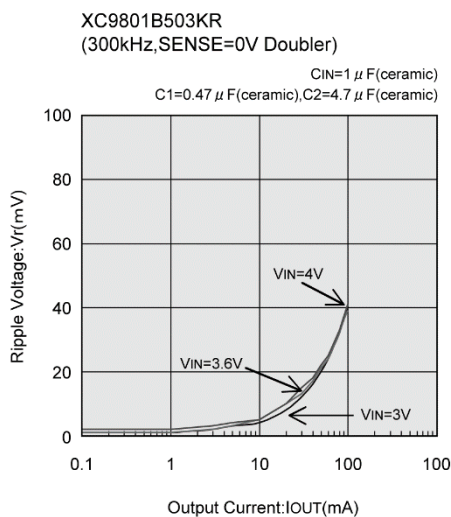

■ PACKAGING INFORMATION

For the latest package information go to, www.torexsemi.com/technical-support/packages

| PACKAGE | OUTLIN / LAND PATTERN | THERMAL CHARACTERISTICS | |
|----------|------------------------------|-------------------------|---|
| MSOP-8A | MSOP-8A PKG | | |
| USP-8 | USP-8 PKG | Standard Board | USP-8 Power Dissipation |
| USP-8B05 | USP-8B05 PKG | | |

MARKING RULE

MSOP-8A

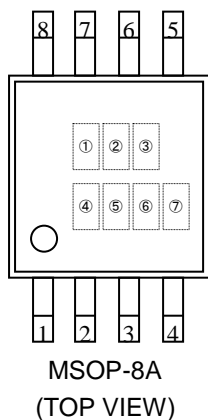

① represents product series

| MARK | PRODUCT SERIES |
|------|----------------|
| 2 | XC9801Bxx3xx |
| 3 | XC9802Bxx3xx |

② represents true logic level at the CE pin

| MARK | PRODUCT SERIES |
|------|---------------------|
| B | XC9801/XC9802Bxx3xx |

③④ represents output voltage

| MARK | | VOLTAGE (V) | PRODUCT SERIES |
|------|---|-------------|---------------------|
| ③ | ④ | | |
| 3 | 3 | 3.3 | XC9801/XC9802B333xx |
| 5 | 0 | 5.0 | XC9801/XC9802B503xx |

USP-8

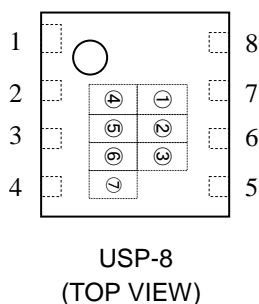

⑤ represents oscillation frequency

| MARK | OSCILLATION FREQUENCY (kHz) | PRODUCT SERIES |
|------|-----------------------------|---------------------|
| 3 | 300 | XC9801/XC9802Bxx3xx |

⑥⑦ represents production lot number

01~09, 0A~0Z, 11~9Z, A1~A9, AA~AZ, B1~ZZ in order.

(G, I, J, O, Q, W excluded)

* No character inversion used.

USP-8B05

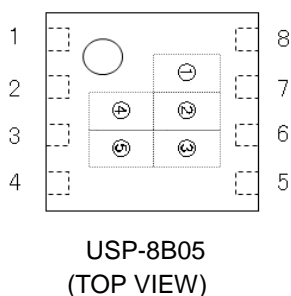

① represents product series

| MARK | PRODUCT SERIES |
|------|------------------|
| 2 | XC9801B xx 3ER-G |
| 3 | XC9802B xx 3ER-G |

②③ represents output voltage

| MARK | | VOLTAGE (V) | PRODUCT SERIES |
|------|---|-------------|-----------------------|
| ② | ③ | | |
| 3 | 3 | 3.3 | XC9801/XC9802B333ER-G |
| 5 | 0 | 5.0 | XC9801/XC9802B503ER-G |

④⑤ represents production lot number

01~09, 0A~0Z, 11~9Z, A1~A9, AA~AZ, B1~ZZ in order.

(G, I, J, O, Q, W excluded)