

Regulated Voltage Step-Up Charge Pump ICs

■ GENERAL DESCRIPTION

The XC9801 series are fixed regulated voltage step-up charge pump ICs which provide stable, highly efficient, positive voltages with the only external components required being 2 capacitors.

Since regulating is done via the control of the charge pump's gate voltage waveform, ripple is minimal. Output voltage is selectable in 100mV steps within a 2.5V ~ 6.0V range.

Control of the XC9802 switches to PFM (pulse skip) during light loads without affecting output impedance or ripple so that the IC is protected against drops in efficiency. Connecting the SENSE pin to the GND pin allows the IC to be used as a voltage doubler.

As well as the ultra small MSOP-8A and USP-8 and USP-8B05 packages, the small consumption current and high efficiencies of the series make the XC9801 suitable for use with all types of battery operated applications.

■ APPLICATIONS

- Power supplies for TFT
- Power supplies for Opamp
- Smart card
- On board local power supplies
- Various battery powered devices

■ FEATURES

- Input Voltage Range** : 1.8V ~ 5.5V
- Output Voltage Range** : 2.5V ~ 6.0V
- Small Input Current** : 80 μ A (no load:XC9802)
- Output Current** : 80mA (3.6V→5.0V step-up)
- Oscillation Frequency** : 300 kHz
- Stand-by Current (CE 'L')** : 2.0 μ A (MAX.)
- PFM Operation During Light Loads (XC9802)**
- CE (Chip Enable) Function**
- Can be used as a step-up doubler (sense = 0V)**
- Packages** : MSOP-8A, USP-8, USP-8B05
- Environmentally Friendly** : EU RoHS Compliant, Pb Free

■ TYPICAL APPLICATION CIRCUIT

Regulation Output

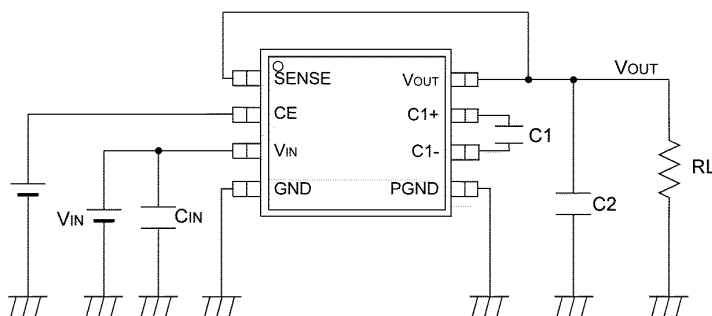

■ TYPICAL PERFORMANCE CHARACTERISTICS

XC9802B503KR(300kHz,5.0V)

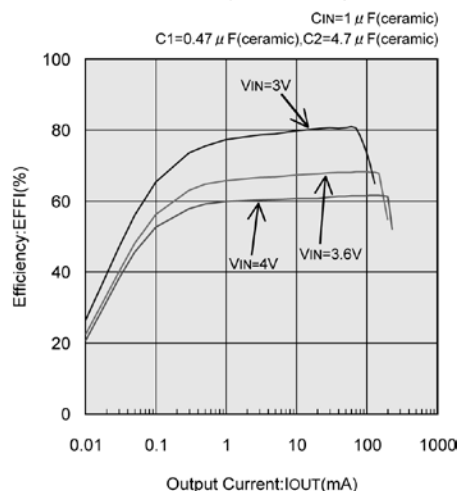

■ BLOCK DIAGRAM

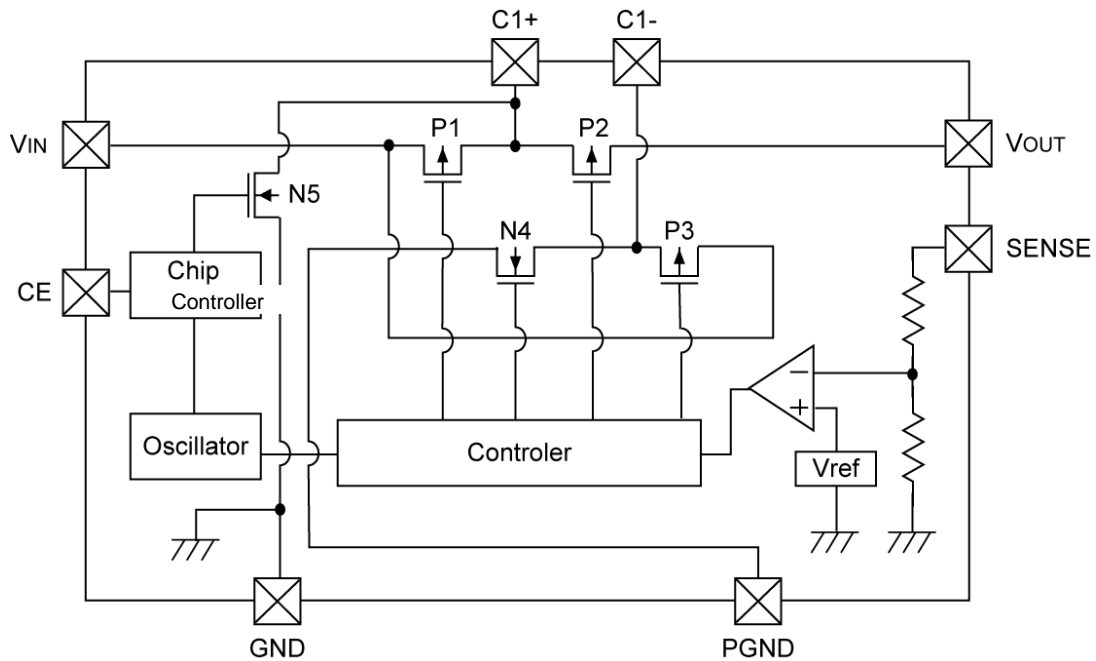

■ PRODUCT CLASSIFICATION

● Ordering Information

XC9801/XC9802 ①②③④⑤⑥-⑦^(*)

DESIGNATOR	ITEM	SYMBOL	DESCRIPTION
①	True Logic Level at CE Pin	B	Positive
②③	Output Voltage	50	Standard voltage $V_{OUT}=5.0V \rightarrow$ ②=5, ③=0
		25 ~ 60	Semi-custom voltage e.g. $V_{OUT}=2.5V \rightarrow$ ②=2, ③=5
④	Oscillation Frequency	3	300kHz
⑤⑥-⑦	Packages (Order Unit)	KR	MSOP-8A (1,000pcs/Reel)
		KR-G	MSOP-8A (1,000pcs/Reel)
		DR	USP-8 (3,000pcs/Reel)
		DR-G	USP-8 (3,000pcs/Reel)
		ER-G	USP-8B05 (5,000pcs/Reel)

Regulated output voltage function cannot be used by the following input voltage condition:

$$V_{IN} < (V_{OUT}/2), \text{ or } V_{IN} \geq V_{OUT}$$

(*1) The "-G" suffix denotes Halogen and Antimony free as well as being fully EU RoHS compliant.

● Selection Guide

SERIES	PULSE SKIP MODE
XC9801	Not Available
XC9802	Available

■ PIN CONFIGURATION

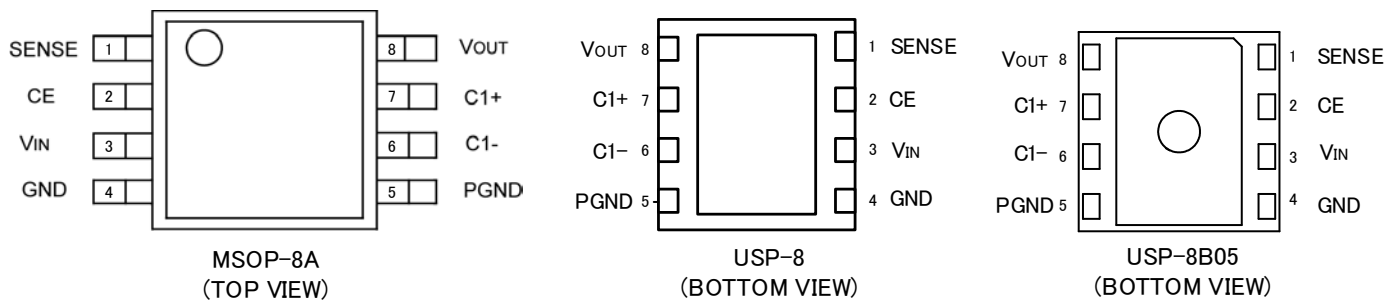

* The dissipation pad for the USP-8 and USP-8B05 package should be solder-plated in recommended mount pattern and metal masking so as to enhance mounting strength and heat release.
If the pad needs to be connected to other pins, it should be connected to the GND (No. 4, 5) pin.

■ PIN ASSIGNMENT

PIN NUMBER			PIN NAME	FUNCTION
USP-8	MSOP-8A	USP-8B05		
1	1	1	SENSE	Output Voltage Monitor
2	2	2	CE	Chip Enable (High Active)
3	3	3	VIN	Input (Power Supply)
4	4	4	GND	Ground
5	5	5	PGND	Power Ground
6	6	6	C1-	External Capacitor - Pin
7	7	7	C1+	External Capacitor + Pin
8	8	8	VOUT	Output

■ FUNCTION

PIN NAME	SIGNAL	STATUS
CE	H	Active
	L	Stand-by

* Please do not leave the CE pin open

■ ABSOLUTE MAXIMUM RATINGS

PARAMETER	SYMBOL	CONDITIONS	UNITS	
V _{IN} pin Voltage	V _{IN}	-0.3~6.0	V	
V _{OUT} pin Voltage	V _{OUT}	-0.3~12.0	V	
C1 + pin Voltage	C1+	-0.3~V _{OUT} +0.3	V	
C1 - pin Voltage	C1-	-0.3~V _{OUT} +0.3	V	
CE pin Voltage	VCE	-0.3~V _{IN} +0.3	V	
SENSE pin Voltage	VSENSE	-0.3~12.0	V	
V _{OUT} Pin Output Current	I _{OUT}	200	mA	
Power Dissipation	MSOP-8A	Pd	150	mW
	USP-8		120	
	1200 (40mm x 40mm Standard board) ^(*)			
	USP-8B05		120	
Operating Temperature Range	Topr	-40~+85	°C	
Storage Temperature Range	Tstg	-40~+125	°C	

^(*) The power dissipation figure shown is PCB mounted and is for reference only.
The mounting condition is please refer to PACKAGING INFORMATION.

■ ELECTRICAL CHARACTERISTICS

XC9801Bxx3K V_{OUT}=*.*V

T_a=25°C

PARAMETER	SYMBOL	CONDITIONS		MIN.	TYP.	MAX.	UNITS	CIRCUIT
Output Voltage	V _{OUT}	Regulation Output	I _{OUT} =1mA	①	②	③	V	3
Load Regulation	ΔV _{OUT}	Regulation Output	⑨	⑤	-	⑥	mV	3
Operating Voltage Range	V _{IN}	Doubler Output, V _{OUT} >V _{IN} × 2 × 0.95		1.8	-	5.5	V	4
Supply Current	I _{DD}	V _{IN} =3.6V, External Components=CIN only, SENSE=0V, V _{OUT} =V _{IN}		1	3	6	mA	1
Stand-by Current	I _{STB}	CE=0V		-	-	2.0	μA	3
Oscillation Frequency	FOSC	External Component=CIN only, SENSE=0V, V _{OUT} open		255	300	345	kHz	2
Output Impedance ^(*)	ROUT	Doubler Output, V _{IN} =3.6V	I _{OUT} =10mA	-	20	40	Ω	4
No Load Input Current	I _{IN}	Doubler Output, V _{IN} =3.6V		-	5	-	mA	4
	I _{IN2}	Regulation Output		-	⑦	-	mA	3
Voltage Converting Efficiency ^(*)	VEFF1	Doubler Output, V _{IN} =3.6V		95	99	-	%	4
Power Converting Efficiency	EFF1	Doubler Output, V _{IN} =3.6V	I _{OUT} =10mA	73	78	-	%	4
	EFF12	Regulation Output	I _{OUT} =1mA	-	⑧	-	%	3
	EFF13		⑨	64	69	-	%	3
CE / 'H' Level Voltage	V _{CEH}			1.5	-	-	V	3
CE / 'L' Level Voltage	V _{CEL}			-	-	0.25	V	3
CE / Input Current	I _{CE}	V _{IN} =5.5V, SENSE=0V, External Components=CIN only		-2.0	-	2.0	μA	5

Test Conditions: Unless otherwise stated, Typical Application Circuit, V_{IN}=Setting Voltage × 0.72V,
GND=0V, CE=V_{IN}, No Load, SENSE=V_{OUT} (Regulation Output)

■ ELECTRICAL CHARACTERISTICS(Continued)

XC9802Bxx3K $V_{OUT} = * . * V$

$T_a = 25^\circ C$

PARAMETER	SYMBOL	CONDITIONS		MIN.	TYP.	MAX.	UNITS	CIRCUIT
Output Voltage	V_{OUT}	Regulation Output	$I_{OUT}=1mA$	①	②	③	V	3
Load Regulation	ΔV_{OUT}	Regulation Output	④	⑤	-	⑥	mV	3
Operating Voltage Range	V_{IN}	Doubler Output, $V_{OUT} > V_{IN} \times 2 \times 0.95$		1.8	-	5.5	V	4
Supply Current	I_{DD}	$V_{IN}=3.6V$, External Components=CIN only, SENSE=0V, $V_{OUT}=V_{IN}$		1	3	6	mA	1
Stand-by Current	I_{STB}	CE=0V		-	-	2.0	μA	3
Oscillation Frequency	FOSC	External Component = CIN only, SENSE=0V, V_{OUT} open		255	300	345	kHz	2
Switching Pulse Frequency	FOSC2	Regulation Output	$I_{OUT}=1mA$	-	10	-	kHz	3
Output Impedance ⁽¹⁾	R_{OUT}	Doubler Output, $V_{IN}=3.6V$	$I_{OUT}=10mA$	-	20	40	Ω	4
No Load Input Current	I_{IN}	Doubler Output, $V_{IN}=3.6V$		-	5	-	mA	3
	I_{IN2}	Regulation Output		-	⑦	-	mA	4
Voltage Converting Efficiency ⁽²⁾	VEFF1	Doubler Output, $V_{IN}=3.6V$		98	99	-	%	4
Power Converting Efficiency	EFF1	Doubler Output, $V_{IN}=3.6V$	$I_{OUT}=10mA$	73	78	-	%	4
	EFFI2	Regulation Output	$I_{OUT}=1mA$	-	⑧	-	%	3
	EFFI3		④	64	69	-	%	3
CE / 'H' Level Voltage	V_{CEH}			1.5	-	-	V	3
CE / 'L' Level Voltage	V_{CEL}			-	-	0.25	V	3
CE / Input Current	I_{CE}	$V_{IN}=5.5V$, SENSE=0V, External Components=CIN only		-2.0	-	2.0	μA	5

Test Conditions: Unless otherwise stated, Typical Application Circuit, $V_{IN} = \text{Setting Voltage} \times 0.72V$, GND=0V, CE= V_{IN} , No Load, SENSE= V_{OUT} (Regulation Output)

⁽¹⁾ Output Impedance Calculation formula

$$R_{OUT} = \frac{V_{OUT1} - V_{OUT2}}{I_{OUT}}$$

V_{OUT1} ($I_{OUT}=0mA$ Output Current)
 V_{OUT2} ($I_{OUT}=10mA$ Output Current)
 $I_{OUT}=10mA$

⁽²⁾ Voltage Converting Efficiency Calculation formula

$$EFFI = \frac{V_{OUT} \times I_{OUT}}{V_{IN} \times I_{IN}} \times 100$$

V_{IN} (Input Voltage)
 I_{IN} (Input Current)
 V_{OUT} ($I_{OUT}=**mA$ Output Voltage)
 I_{OUT} (Output Current)

■ ELECTRICAL CHARACTERISTICS (Continued)

XC9801series SPEC

Nominal Detect [V]	SYMBOL								
	①	②	③	⑤	⑥	④	⑦	⑧	⑨
	Output Voltage			Load Regulation			Input Current	Power Converting Efficiency	
	V _{OUT}			ΔV _{OUT}			IIN2	EFF2	EFF3
MIN.	TYP.	MAX.	MIN.	MAX.	conditions	TYP.	TYP.	conditions	
2.5	2.438	2.5	2.563	-50	50	1mA ≤ I _{OUT} ≤ 10mA	1.0	52	I _{OUT} =10mA
2.6	2.535	2.6	2.665	-52	52	1mA ≤ I _{OUT} ≤ 13mA	1.0	52	I _{OUT} =13mA
2.7	2.633	2.7	2.768	-54	54	1mA ≤ I _{OUT} ≤ 16mA	1.0	51	I _{OUT} =16mA
2.8	2.730	2.8	2.870	-56	56	1mA ≤ I _{OUT} ≤ 18mA	1.1	51	I _{OUT} =18mA
2.9	2.828	2.9	2.973	-58	58	1mA ≤ I _{OUT} ≤ 21mA	1.1	50	I _{OUT} =21mA
3.0	2.925	3.0	3.075	-60	60	1mA ≤ I _{OUT} ≤ 24mA	1.1	50	I _{OUT} =24mA
3.1	3.023	3.1	3.178	-62	62	1mA ≤ I _{OUT} ≤ 27mA	1.1	49	I _{OUT} =27mA
3.2	3.120	3.2	3.280	-64	64	1mA ≤ I _{OUT} ≤ 30mA	1.1	49	I _{OUT} =30mA
3.3	3.218	3.3	3.383	-66	66	1mA ≤ I _{OUT} ≤ 32mA	1.1	48	I _{OUT} =32mA
3.4	3.315	3.4	3.485	-68	68	1mA ≤ I _{OUT} ≤ 35mA	1.2	48	I _{OUT} =35mA
3.5	3.413	3.5	3.588	-70	70	1mA ≤ I _{OUT} ≤ 38mA	1.2	47	I _{OUT} =38mA
3.6	3.510	3.6	3.690	-72	72	1mA ≤ I _{OUT} ≤ 41mA	1.2	47	I _{OUT} =41mA
3.7	3.608	3.7	3.793	-74	74	1mA ≤ I _{OUT} ≤ 44mA	1.2	46	I _{OUT} =44mA
3.8	3.705	3.8	3.895	-76	76	1mA ≤ I _{OUT} ≤ 46mA	1.2	46	I _{OUT} =46mA
3.9	3.803	3.9	3.998	-78	78	1mA ≤ I _{OUT} ≤ 49mA	1.3	45	I _{OUT} =49mA
4.0	3.900	4.0	4.100	-80	80	1mA ≤ I _{OUT} ≤ 52mA	1.3	45	I _{OUT} =52mA
4.1	3.998	4.1	4.203	-82	82	1mA ≤ I _{OUT} ≤ 55mA	1.3	44	I _{OUT} =55mA
4.2	4.095	4.2	4.305	-84	84	1mA ≤ I _{OUT} ≤ 58mA	1.3	44	I _{OUT} =58mA
4.3	4.193	4.3	4.408	-86	86	1mA ≤ I _{OUT} ≤ 60mA	1.3	43	I _{OUT} =60mA
4.4	4.290	4.4	4.510	-88	88	1mA ≤ I _{OUT} ≤ 63mA	1.3	43	I _{OUT} =63mA
4.5	4.388	4.5	4.613	-90	90	1mA ≤ I _{OUT} ≤ 66mA	1.4	42	I _{OUT} =66mA
4.6	4.485	4.6	4.715	-92	92	1mA ≤ I _{OUT} ≤ 69mA	1.4	42	I _{OUT} =69mA
4.7	4.583	4.7	4.818	-94	94	1mA ≤ I _{OUT} ≤ 72mA	1.4	41	I _{OUT} =72mA
4.8	4.680	4.8	4.920	-96	96	1mA ≤ I _{OUT} ≤ 74mA	1.4	41	I _{OUT} =74mA
4.9	4.778	4.9	5.023	-98	98	1mA ≤ I _{OUT} ≤ 77mA	1.5	40	I _{OUT} =77mA
5.0	4.875	5.0	5.125	-100	100	1mA ≤ I _{OUT} ≤ 80mA	1.5	40	I _{OUT} =80mA
5.1	4.973	5.1	5.228	-102	102	1mA ≤ I _{OUT} ≤ 83mA	1.5	39	I _{OUT} =83mA
5.2	5.070	5.2	5.330	-104	104	1mA ≤ I _{OUT} ≤ 86mA	1.5	39	I _{OUT} =86mA
5.3	5.168	5.3	5.433	-106	106	1mA ≤ I _{OUT} ≤ 89mA	1.6	38	I _{OUT} =89mA
5.4	5.265	5.4	5.535	-108	108	1mA ≤ I _{OUT} ≤ 91mA	1.6	38	I _{OUT} =91mA
5.5	5.363	5.5	5.638	-110	110	1mA ≤ I _{OUT} ≤ 94mA	1.6	37	I _{OUT} =94mA
5.6	5.460	5.6	5.740	-112	112	1mA ≤ I _{OUT} ≤ 97mA	1.6	37	I _{OUT} =97mA
5.7	5.558	5.7	5.843	-114	114	1mA ≤ I _{OUT} ≤ 100mA	1.7	36	I _{OUT} =100mA
5.8	5.655	5.8	5.945	-116	116	1mA ≤ I _{OUT} ≤ 102mA	1.7	36	I _{OUT} =102mA
5.9	5.753	5.9	6.048	-118	118	1mA ≤ I _{OUT} ≤ 105mA	1.7	35	I _{OUT} =105mA
6.0	5.850	6.0	6.150	-120	120	1mA ≤ I _{OUT} ≤ 108mA	1.7	35	I _{OUT} =108mA

■ ELECTRICAL CHARACTERISTICS (Continued)

XC9802 series SPEC

Nominal Detect [V]	SYMBOL								
	①	②	③	⑤	⑥	④	⑦	⑧	⑨
	Output Voltage			Load Regulation			Input Current	Power Converting Efficiency	
	V _{OUT}			ΔV _{OUT}			I _{IN2}	EFF2	EFF3
MIN.	TYP.	MAX.	MIN.	MAX.	conditions	TYP.	TYP.	conditions	
2.5	2.438	2.5	2.563	-50	50	1mA ≤ I _{OUT} ≤ 10mA	0.08	65	I _{OUT} =10mA
2.6	2.535	2.6	2.665	-52	52	1mA ≤ I _{OUT} ≤ 13mA	0.08	65	I _{OUT} =13mA
2.7	2.633	2.7	2.768	-54	54	1mA ≤ I _{OUT} ≤ 16mA	0.08	65	I _{OUT} =16mA
2.8	2.730	2.8	2.870	-56	56	1mA ≤ I _{OUT} ≤ 18mA	0.08	65	I _{OUT} =18mA
2.9	2.828	2.9	2.973	-58	58	1mA ≤ I _{OUT} ≤ 21mA	0.08	64	I _{OUT} =21mA
3.0	2.925	3.0	3.075	-60	60	1mA ≤ I _{OUT} ≤ 24mA	0.08	64	I _{OUT} =24mA
3.1	3.023	3.1	3.178	-62	62	1mA ≤ I _{OUT} ≤ 27mA	0.08	64	I _{OUT} =27mA
3.2	3.120	3.2	3.280	-64	64	1mA ≤ I _{OUT} ≤ 30mA	0.08	64	I _{OUT} =30mA
3.3	3.218	3.3	3.383	-66	66	1mA ≤ I _{OUT} ≤ 32mA	0.08	63	I _{OUT} =32mA
3.4	3.315	3.4	3.485	-68	68	1mA ≤ I _{OUT} ≤ 35mA	0.08	63	I _{OUT} =35mA
3.5	3.413	3.5	3.588	-70	70	1mA ≤ I _{OUT} ≤ 38mA	0.08	63	I _{OUT} =38mA
3.6	3.510	3.6	3.690	-72	72	1mA ≤ I _{OUT} ≤ 41mA	0.08	63	I _{OUT} =41mA
3.7	3.608	3.7	3.793	-74	74	1mA ≤ I _{OUT} ≤ 44mA	0.08	62	I _{OUT} =44mA
3.8	3.705	3.8	3.895	-76	76	1mA ≤ I _{OUT} ≤ 46mA	0.08	62	I _{OUT} =46mA
3.9	3.803	3.9	3.998	-78	78	1mA ≤ I _{OUT} ≤ 49mA	0.08	62	I _{OUT} =49mA
4.0	3.900	4.0	4.100	-80	80	1mA ≤ I _{OUT} ≤ 52mA	0.08	62	I _{OUT} =52mA
4.1	3.998	4.1	4.203	-82	82	1mA ≤ I _{OUT} ≤ 55mA	0.08	61	I _{OUT} =55mA
4.2	4.095	4.2	4.305	-84	84	1mA ≤ I _{OUT} ≤ 58mA	0.08	61	I _{OUT} =58mA
4.3	4.193	4.3	4.408	-86	86	1mA ≤ I _{OUT} ≤ 60mA	0.08	61	I _{OUT} =60mA
4.4	4.290	4.4	4.510	-88	88	1mA ≤ I _{OUT} ≤ 63mA	0.08	61	I _{OUT} =63mA
4.5	4.388	4.5	4.613	-90	90	1mA ≤ I _{OUT} ≤ 66mA	0.08	60	I _{OUT} =66mA
4.6	4.485	4.6	4.715	-92	92	1mA ≤ I _{OUT} ≤ 69mA	0.08	60	I _{OUT} =69mA
4.7	4.583	4.7	4.818	-94	94	1mA ≤ I _{OUT} ≤ 72mA	0.08	60	I _{OUT} =72mA
4.8	4.680	4.8	4.920	-96	96	1mA ≤ I _{OUT} ≤ 74mA	0.08	60	I _{OUT} =74mA
4.9	4.778	4.9	5.023	-98	98	1mA ≤ I _{OUT} ≤ 77mA	0.08	60	I _{OUT} =77mA
5.0	4.875	5.0	5.125	-100	100	1mA ≤ I _{OUT} ≤ 80mA	0.08	59	I _{OUT} =80mA
5.1	4.973	5.1	5.228	-102	102	1mA ≤ I _{OUT} ≤ 83mA	0.08	59	I _{OUT} =83mA
5.2	5.070	5.2	5.330	-104	104	1mA ≤ I _{OUT} ≤ 86mA	0.08	59	I _{OUT} =86mA
5.3	5.168	5.3	5.433	-106	106	1mA ≤ I _{OUT} ≤ 89mA	0.08	58	I _{OUT} =89mA
5.4	5.265	5.4	5.535	-108	108	1mA ≤ I _{OUT} ≤ 91mA	0.08	58	I _{OUT} =91mA
5.5	5.363	5.5	5.638	-110	110	1mA ≤ I _{OUT} ≤ 94mA	0.08	58	I _{OUT} =94mA
5.6	5.460	5.6	5.740	-112	112	1mA ≤ I _{OUT} ≤ 97mA	0.08	58	I _{OUT} =97mA
5.7	5.558	5.7	5.843	-114	114	1mA ≤ I _{OUT} ≤ 100mA	0.08	57	I _{OUT} =100mA
5.8	5.655	5.8	5.945	-116	116	1mA ≤ I _{OUT} ≤ 102mA	0.08	57	I _{OUT} =102mA
5.9	5.753	5.9	6.048	-118	118	1mA ≤ I _{OUT} ≤ 105mA	0.08	57	I _{OUT} =105mA
6.0	5.850	6.0	6.150	-120	120	1mA ≤ I _{OUT} ≤ 108mA	0.08	57	I _{OUT} =108mA

TYPICAL CIRCUITS

CIRCUIT①

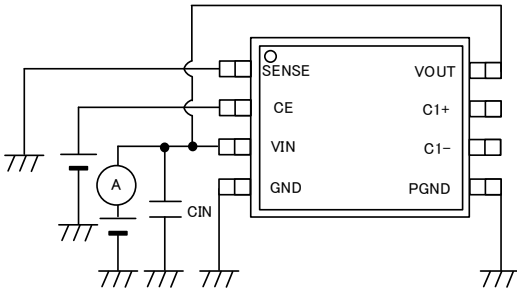

CIRCUIT②

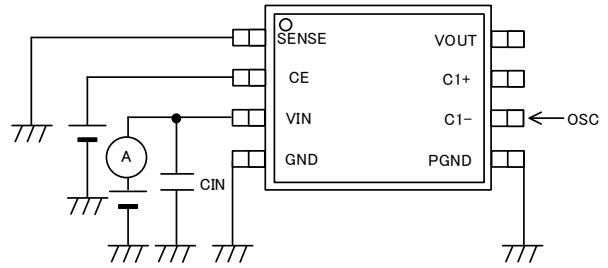

CIRCUIT③

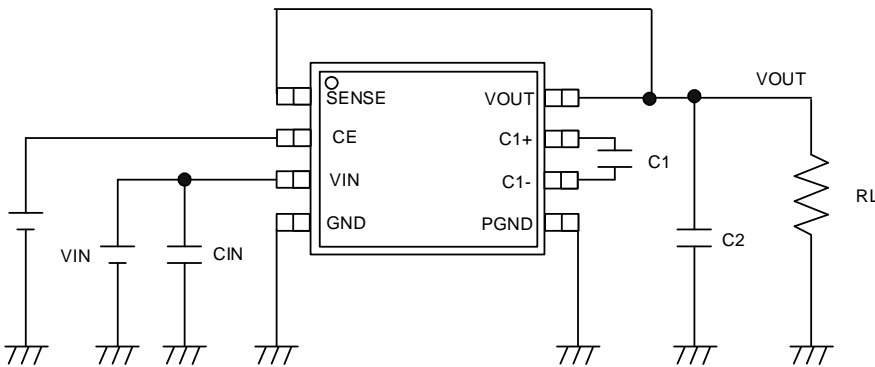

[External parts]

$C_{IN}=1\mu F$

$C1=0.47\mu F$

$C2=4.7\mu F$

CIRCUIT④

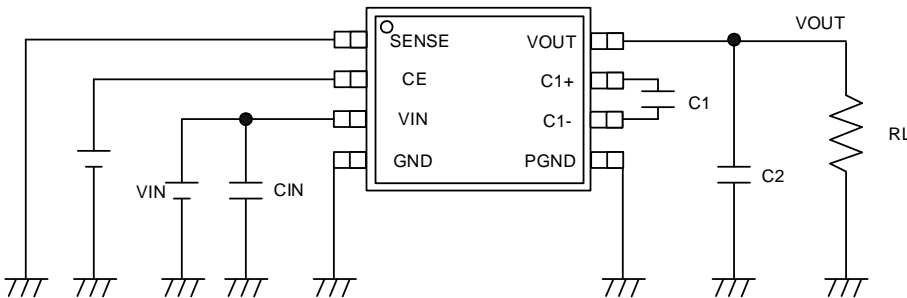

[External parts]

$C_{IN}=1\mu F$

$C1=0.47\mu F$

$C2=4.7\mu F$

CIRCUIT⑤

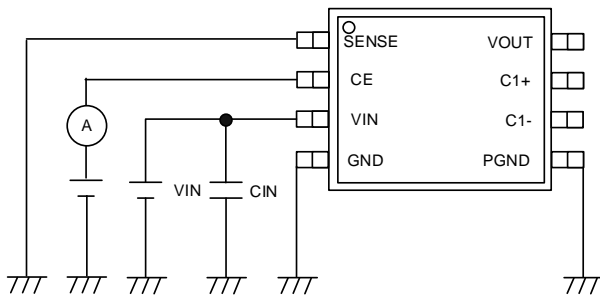

TYPICAL APPLICATION CIRCUITS

① Regulation Output

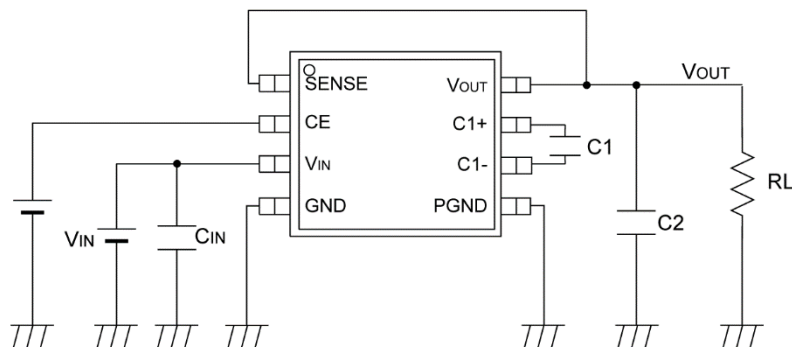

② Doubler Output

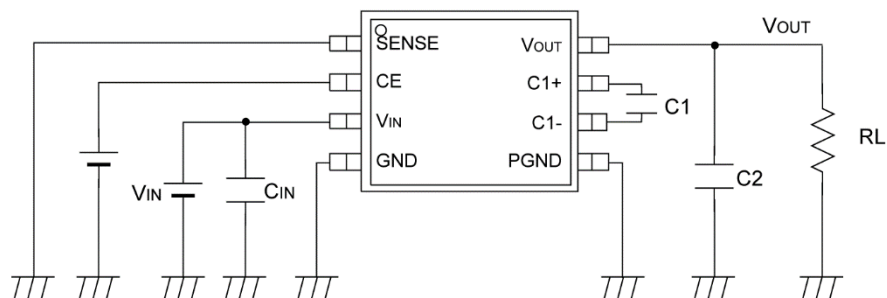

【Typical Examples】

	MANUFACTURER	PRODUCT NUMBER	VALUE	SIZE(L×W×T)
CIN	TAIYO YUDEN	LMK107BJ105KA	1μF/10V	1.6×0.8×0.8(mm)
	Murata	GRM033R61A225KE47	2.2μF/10V	0.6×0.3×0.33(mm)
C1	TAIYO YUDEN	LMK107BJ474KA	0.47μF/10V	1.6×0.8×0.8(mm)
	Murata	GRM033R61A105ME15	1μF/10V	0.6×0.3×0.33(mm)
C2	TAIYO YUDEN	LMK107BJ475KA	4.7μF/10V	1.6×0.8×0.8(mm)
	Murata	GRM153R60J475ME15	4.7μF/6.3V, 2parallel	1.0×0.5×0.33(mm)

Note: The XC9801 series are step-up charge pump voltage doublers which provide regulated output voltage.

The application circuit of the doubler output (②) halts the regulated output function and operates as a normal voltage doubler.

The output voltage is stable when connected as in (①) above, except when $V_{IN} < (V_{OUT} / 2)$ and $V_{IN} \geq V_{OUT}$.

■ OPERATIONAL EXPLANATION

(1) Basic Operations

Using the XC9801/02's clock generated by the internal oscillator, a step-up charge pump operation can be brought about as a result of the alternate switching between operating conditions where P1 & N4 are ON with P2 & P3 OFF (or) P1 & N4 are OFF with P2 & P3 ON. By connecting the SENSE pin to V_{OUT} , output voltage can be feedback and the difference between the feedback voltage and the reference voltage (V_{ref}) are compared by the internal operational amplifier. Output voltage can be stabilized (* 2) by controlling P3's gate voltage waveform via the signal generated by the internal amplifier.

Please note that this stabilizing function will not operate with $V_{IN} < (V_{OUT}/2)$ or $V_{IN} \geq V_{OUT}$.

By connecting SENSE to ground, the output stability function, as described above, can be halted and the IC can be used as a step-up doubler.

* 2: As a result of P3 gradually reaching an ON state with each clock (signal), rush current is controlled, the ripple decreases and with the combination of the independent phase compensation circuit, output voltage is stabilized

(2) Stand-by

When the voltage at CE (chip enable) is 'low' (0V), P1, P2 & P3 will be OFF with N4 & N5 ON. The external capacitor C1 will discharge and impedance at V_{OUT} will be high.

(3) PFM (Pulse Skip) Operations

Whilst maintaining output voltage, the XC9802 provides the added security of protection against drops in efficiency during light loads as a result of the pulse, generated by the internal oscillator, being skipped and the operating frequency being changed.

■ NOTE ON USE

1. For the phenomenon of temporal and transitional voltage decrease or voltage increase, the IC may be damaged or deteriorated if IC is used beyond the absolute MAX specifications.
2. When using a capacitor, please select one with low ESR, Equivalent Series Resistance, like ceramic capacitors. And please use a ceramic capacitor with B-characteristics of which static capacitance decreases less. Otherwise, the characteristics of the IC can significantly decrease.
3. However, please bear in mind that the output stabilization function cannot be used under the condition of $V_{IN} < (V_{OUT}/2)$ or $V_{IN} \geq V_{OUT}$.
4. Torex places an importance on improving our products and their reliability. We request that users incorporate fail-safe designs and post-aging protection treatment when using Torex products in their systems.

TYPICAL PERFORMANCE CHARACTERISTICS

● XC9801B333KR (300kHz, 3.3V)

(1) Output Voltage vs. Output Current

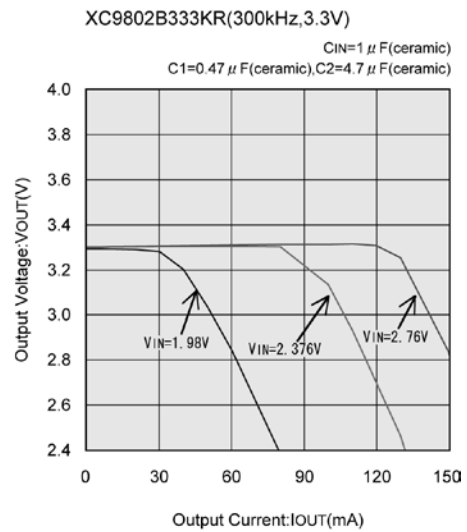
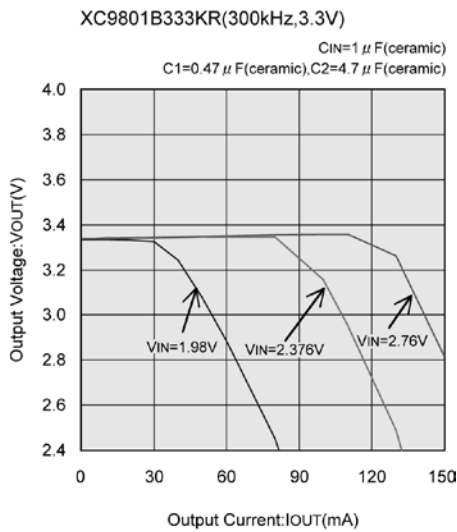

(2) Efficiency vs. Output Current

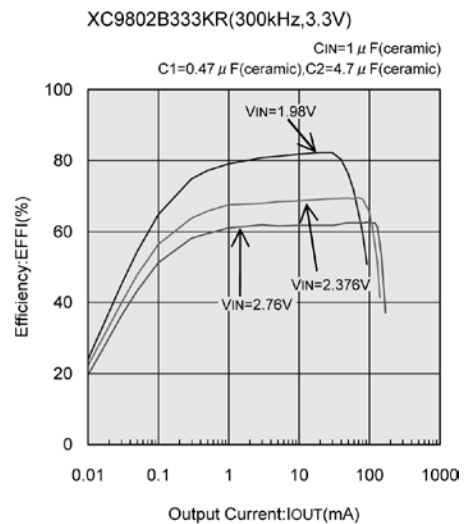
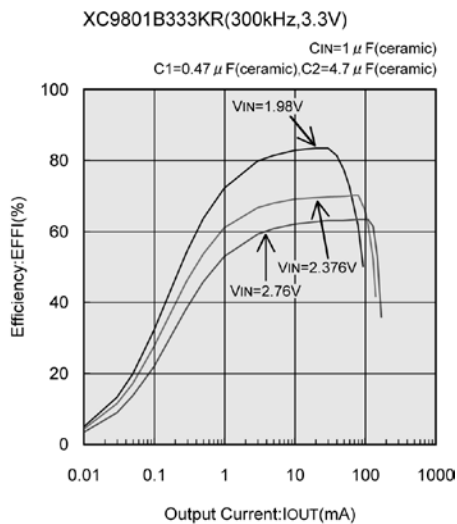

(3) Ripple Voltage vs. Output Current

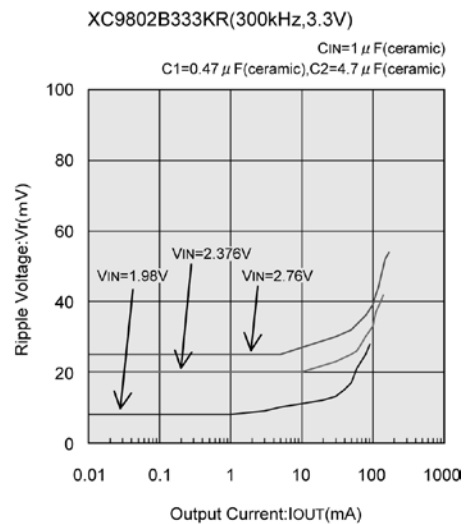
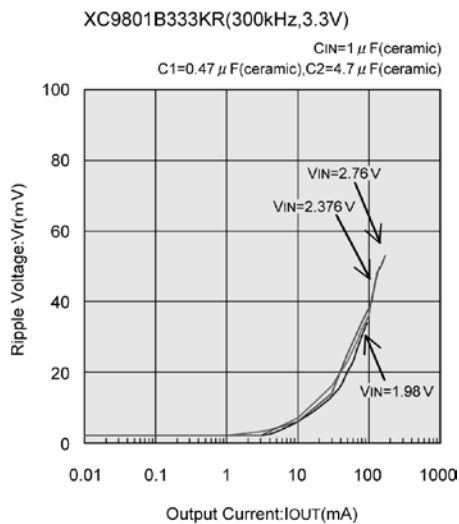

■ TYPICAL PERFORMANCE CHARACTERISTICS (Continued)

● XC9801B503KR (300kHz, 5.0V)

(1) Output Voltage vs. Output Current

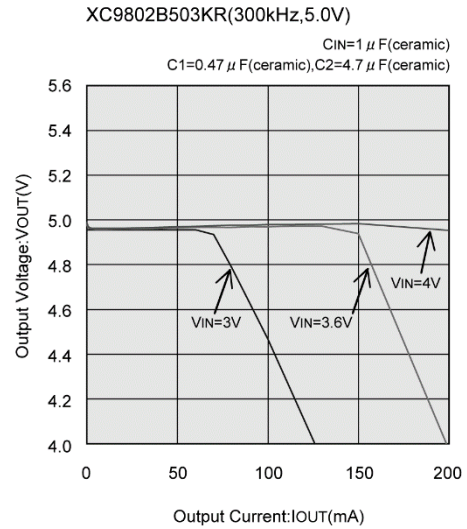
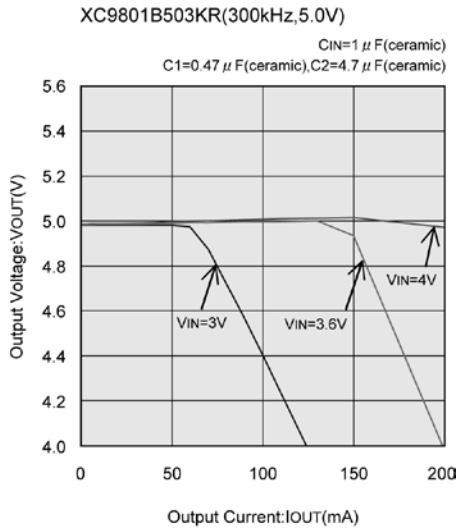

(2) Efficiency vs. Output Current

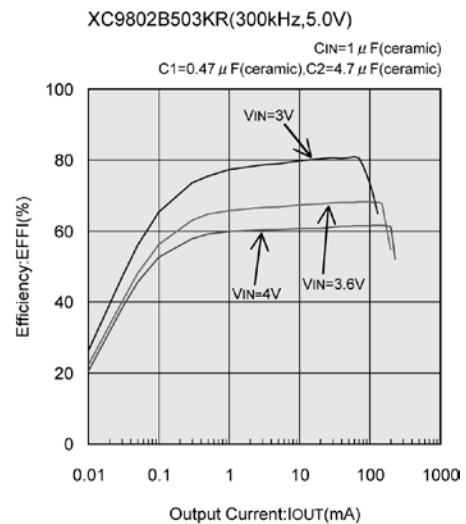
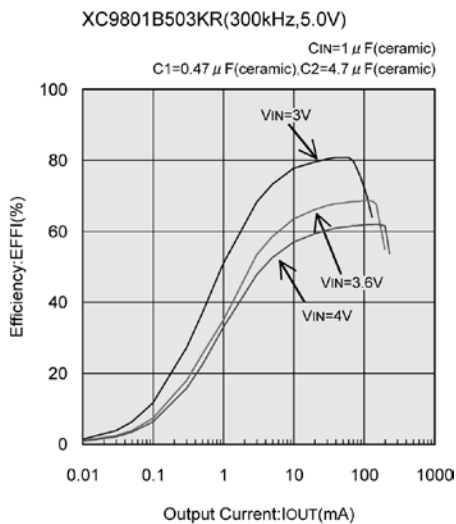

(3) Ripple Voltage vs. Output Current

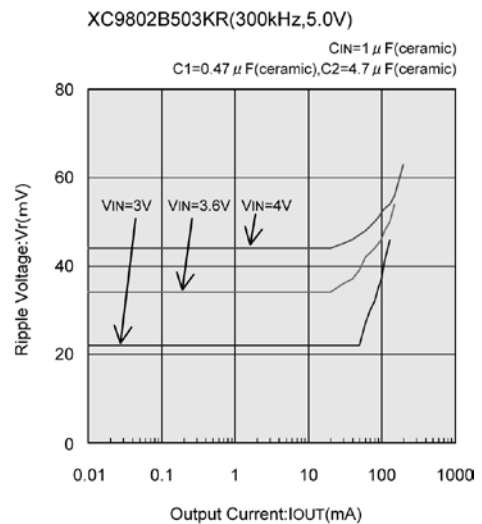
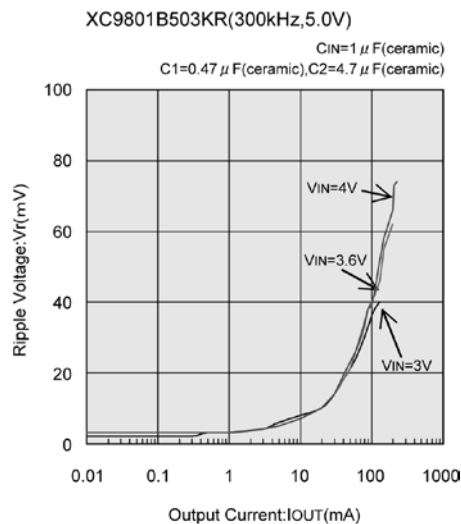

TYPICAL PERFORMANCE CHARACTERISTICS (Continued)

● XC9801B503KR (300kHz, SENSE=0V, Doubler)

(1) Output Voltage vs. Output Current

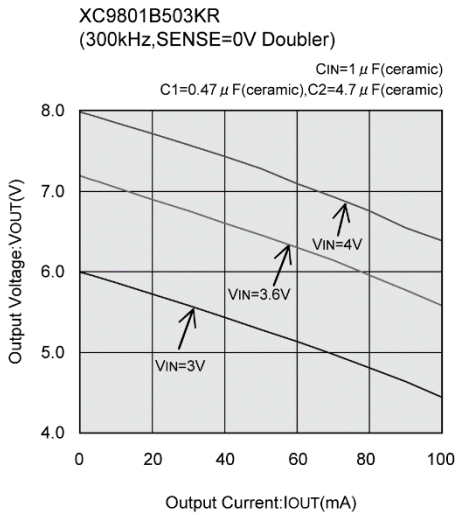

(2) Efficiency vs. Output Current

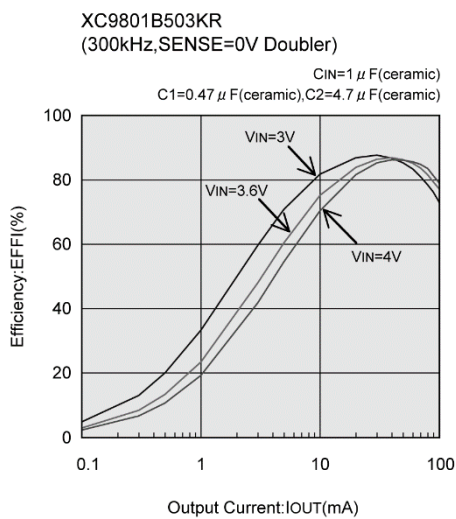

(3) Ripple Voltage vs. Output Current

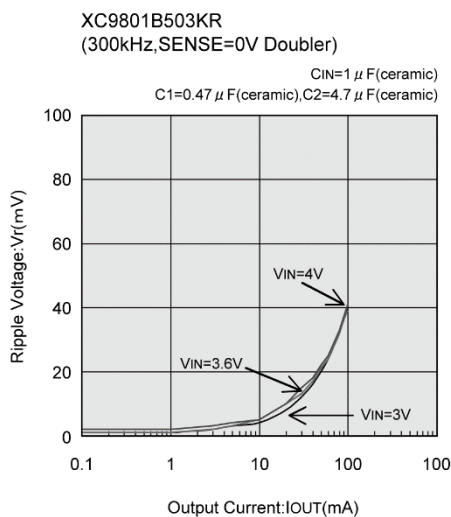

■ PACKAGING INFORMATION

For the latest package information go to, www.torexsemi.com/technical-support/packages

PACKAGE	OUTLIN / LAND PATTERN	THERMAL CHARACTERISTICS	
MSOP-8A	MSOP-8A PKG		
USP-8	USP-8 PKG	Standard Board	USP-8 Power Dissipation
USP-8B05	USP-8B05 PKG		

MARKING RULE

MSOP-8A

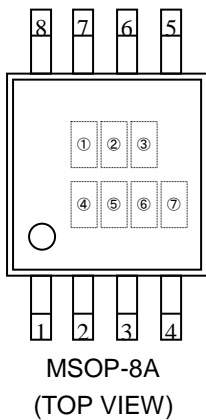

① represents product series

MARK	PRODUCT SERIES
2	XC9801Bxx3xx
3	XC9802Bxx3xx

② represents true logic level at the CE pin

MARK	PRODUCT SERIES
B	XC9801/XC9802Bxx3xx

③④ represents output voltage

MARK		VOLTAGE (V)	PRODUCT SERIES
③	④		
3	3	3.3	XC9801/XC9802B333xx
5	0	5.0	XC9801/XC9802B503xx

USP-8

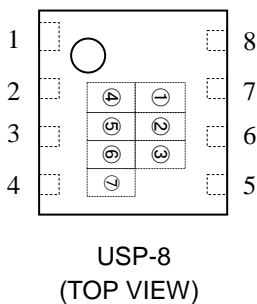

⑤ represents oscillation frequency

MARK	OSCILLATION FREQUENCY (kHz)	PRODUCT SERIES
3	300	XC9801/XC9802Bxx3xx

⑥⑦ represents production lot number
01~09, 0A~0Z, 11~9Z, A1~A9, AA~AZ, B1~ZZ in order.
(G, I, J, O, Q, W excluded)
* No character inversion used.

USP-8B05

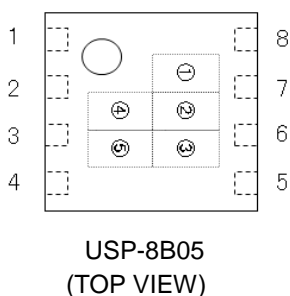

① represents product series

MARK	PRODUCT SERIES
2	XC9801B xx 3ER-G
3	XC9802B xx 3ER-G

②③ represents output voltage

MARK		VOLTAGE (V)	PRODUCT SERIES
②	③		
3	3	3.3	XC9801/XC9802B333ER-G
5	0	5.0	XC9801/XC9802B503ER-G

④⑤ represents production lot number

01~09, 0A~0Z, 11~9Z, A1~A9, AA~AZ, B1~ZZ in order.
(G, I, J, O, Q, W excluded)