

XPSUVN11AP

Safety module, Harmony Safety Automation,
Zero speed monitoring with time delay, 24V
AC/DC, screw



Main

Range of Product	Harmony Safety Automation
Product or Component Type	Safety module
Safety module name	XPSUVN
Safety module application	For zero speed detection
Function of module	Monitoring 3-phase motor Monitoring 3-phase motor with star-delta starting Monitoring 3-phase motor with variable number of poles Monitoring 3-phase motor with variable number of poles and star-delta starting Monitoring dc motor Monitoring servo motor Monitoring 3-phase motor supplied by variable speed drive Monitoring 3-phase motor supplied by servo drive Controlling enegization to open of guard switch type XCSE, XCSLE, XCSLF, XCST
Safety level	Can reach PL e/category 3 for normally open relay contact ISO 13849-1 Can reach SILCL 3 for normally open relay contact IEC 62061 Can reach SIL 3 for normally open relay contact IEC 61508
Safety reliability data	MTTFd > 30 years ISO 13849-1 Dcavg = 98.9 % ISO 13849-1 PFHd = 2.39E-9 1/h ISO 13849-1 HFT = 1 IEC 62061 PFHd = 2.39E-9 1/h IEC 62061 SFF > 99% IEC 62061 HFT = 1 IEC 61508-1 PFHd = 2.39E-9 1/h IEC 61508-1 SFF > 99% IEC 61508-1 Type = B IEC 61508-1
Product Certifications	TÜV cULus
[Us] Rated Supply Voltage	24 V AC - 15...10 % 24 V DC - 20...20 %
Output type	Relay, 1 NO, volt-free
Number of additional circuits	2 solid state outputs

The information provided in this documentation contains general descriptions and/or technical characteristics of the performance of the products contained herein. This documentation is not intended as a substitute for and is not to be used for determining suitability or reliability of these products for specific user applications. It is the duty of any such user or integrator to perform the appropriate and complete risk analysis, evaluation and testing of the products with respect to the relevant specific application or use thereof. Neither Schneider Electric Industries SAS nor any of its affiliates or subsidiaries shall be responsible or liable for misuse of the information contained herein.

Complementary

Power Consumption in W	2.0 W
Power Consumption in VA	5.5 VA
Input voltage	690 V
Input detection threshold	50 mV 65 mV 85 mV 110 mV 140 mV 180 mV 230 mV 300 mV 400 mV 500 mV
Time delay	0.5 s 1 s 2 s 3 s 5 s 8 s 12 s 20 s 35 s 60 s
[Ie] rated operational current	5 A AC-1 for normally open relay contact 3 A AC-15 for normally open relay contact 5 A DC-1 for normally open relay contact 3 A DC-13 for normally open relay contact
[Ith] conventional free air thermal current	6 A NO relay output circuit
Associated fuse rating	6 A gG relay output IEC 60947-1
Standards	IEC 60947-5-1 IEC 61508-1 functional safety standard IEC 61508-2 functional safety standard IEC 61508-3 functional safety standard IEC 61508-4 functional safety standard IEC 61508-5 functional safety standard IEC 61508-6 functional safety standard IEC 61508-7 functional safety standard ISO 13849-1 functional safety standard IEC 62061 functional safety standard
Minimum output current	10 mA relay output
Minimum output voltage	5 V relay output
[Ui] rated insulation voltage	690 V phase to phase 2)EN/IEC 60947-1 400 V phase to earth 2)EN/IEC 60947-1
[Uimp] rated impulse withstand voltage	4 kV II EN/IEC 60947-1
Local signalling	LED green power power ON LED red error error LED yellow state status LED yellow L12 input line comparison LED yellow L32 input line comparison
Connections - terminals	Removable screw terminal block solid or flexible 0.2...2.5 mm ² Removable screw terminal block flexible with ferrule 0.25...2.5 mm ² single conductor Removable screw terminal block solid or flexible 0.2...1.5 mm ² twin conductor Removable screw terminal block flexible with ferrule 2 x 0.25...1 mm ² without cable end, with bezel Removable screw terminal block flexible with ferrule 2 x 0.5...1.5 mm ² with cable end, with bezel
Mounting Support	35 mm symmetrical DIN rail
Depth	4.72 in (120 mm)
Height	3.94 in (100 mm)
Width	0.89 in (22.5 mm)
Net Weight	0.44 lb(US) (0.2 kg)

Environment

IP degree of protection	IP20 terminals)EN/IEC 60529 IP40 housing)EN/IEC 60529 IP54 mounting area)EN/IEC 60529
Ambient Air Temperature for Operation	-13...131 °F (-25...55 °C)
Ambient Air Temperature for Storage	-40...158 °F (-40...70 °C)
Relative Humidity	5...95 % non-condensing

Ordering and shipping details

Category	22477-SAFETY MODULES (PREVENTA)
Discount Schedule	SAF2
GTIN	3606482034051
Returnability	Yes

Packing Units

Unit Type of Package 1	PCE
Number of Units in Package 1	1
Package 1 Height	2.72 in (6.9 cm)
Package 1 Width	5.31 in (13.5 cm)
Package 1 Length	6.18 in (15.7 cm)
Package 1 Weight	9.14 oz (259.0 g)
Unit Type of Package 2	S03
Number of Units in Package 2	16
Package 2 Height	11.81 in (30 cm)
Package 2 Width	11.81 in (30 cm)
Package 2 Length	15.75 in (40 cm)
Package 2 Weight	10.71 lb(US) (4.857 kg)
Package 3 Height	11.81 in (30 cm)

Offer Sustainability





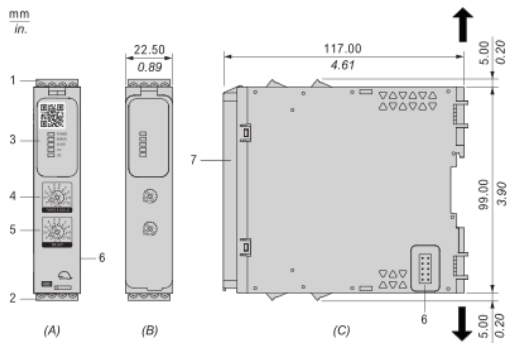

Sustainable offer status	Green Premium product
California proposition 65	WARNING: This product can expose you to chemicals including: Lead and lead compounds, which is known to the State of California to cause cancer and birth defects or other reproductive harm. For more information go to www.P65Warnings.ca.gov
REACH Regulation	REACH Declaration
EU RoHS Directive	Pro-active compliance (Product out of EU RoHS legal scope) EU RoHS Declaration
Mercury free	Yes
China RoHS Regulation	China RoHS Declaration
RoHS exemption information	Yes
Environmental Disclosure	Product Environmental Profile
Circularity Profile	End Of Life Information
WEEE	The product must be disposed on European Union markets following specific waste collection and never end up in rubbish bins.

Dimensions

Front and Side Views

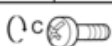

- (A) : Product drawing
- (B) : Screw clamp terminal
- (C) : Side view
- (1) : Removable terminal blocks, top
- (2) : Removable terminal blocks, bottom
- (3) : LED indicators
- (4) : Voltage threshold selector
- (5) : Activation delay selector
- (6) : Connector for optional output extension module XPSUEP (lateral)
- (7) : Sealable transparent cover

mm in.	7.0-8.0 0.28-0.31					
mm ²		0,2... 2,5	0,25...2,5	0,2... 1,5	0,25...1	0,5...1,5
AWG		24... 12	24...12	24...16	24...18	20...16
	Ø 3,5 mm (0.14 in)				Nm	0.5... 0.6
					lb-in	4,4... 5,3

Mounting to DIN rail

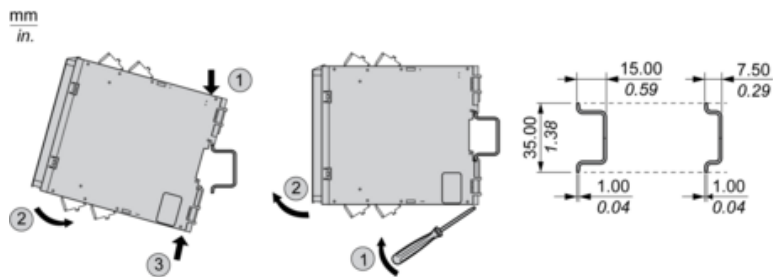

Screw-mounting

