

Product Overview

The CMD192C5 is a wideband GaAs MMIC distributed amplifier which operates from DC to 20 GHz and is housed in a leadless surface mount package. The amplifier delivers greater than 19 dB of gain with a corresponding output 1 dB compression point of +25 dBm and noise figure of 1.9 dB at 10 GHz. The CMD192C5 is a 50 ohm matched design which eliminates the need for RF port matching. This amplifier is the perfect alternative to higher cost hybrid amplifiers.

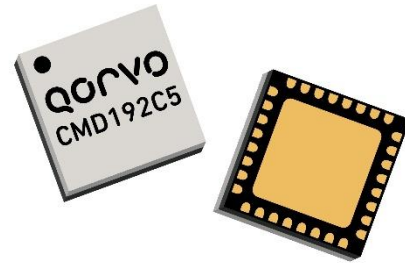

Functional Block Diagram

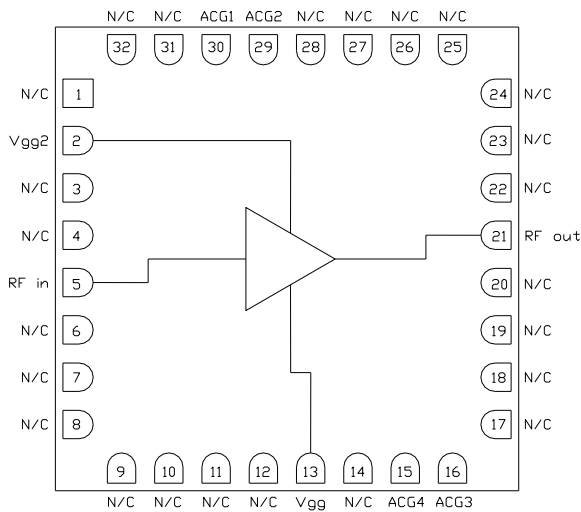

Note: V_{gg2} is optional for gain control

Key Features

- Ultra Wideband Performance
- Positive Gain Slope
- High Output Power
- Low Noise Figure
- Pb-Free RoHs Compliant 5x5 mm SMT Package

Ordering Information

Part No.	Description
CMD192C5	DC-20 GHz Distributed Driver Amplifier, 100 Piece 7" Reel
CMD192C5-EVB	Evaluation Board

Electrical Performance ($V_{dd} = 8.0\text{ V}$, $V_{gg} = -1.0\text{ V}$, $T_A = 25\text{ }^\circ\text{C}$, $F = 10\text{ GHz}$)

Parameter	Min	Typ	Max	Units
Frequency Range		DC - 20		GHz
Gain		19.5		dB
Noise Figure		1.9		dB
Input Return Loss		23		dB
Output Return Loss		13		dB
Output P1dB		25		dBm
Supply Current		200		mA

Absolute Maximum Ratings

Parameter	Rating
Drain Voltage, V_{dd}	10 V
Gate Voltage, V_{gg}	-4 to 0 V
RF Input Power	+23 dBm
Channel Temperature, T_{ch}	150 °C
Power Dissipation, P_{diss}	2.8 W
Thermal Resistance, θ_{JC}	23.2 °C/W
Operating Temperature	-40 to 85 °C
Storage Temperature	-55 to 150 °C

Exceeding any one or combination of the maximum ratings may cause permanent damage to the device.

Recommended Operating Conditions

Parameter	Min	Typ	Max	Units
V_{dd}	5.0	8.0	9.5	V
I_{dd}		200		mA
V_{gg}	-4.0	-1.0	0	V

Electrical performance is measured at specific test conditions. Electrical specifications are not guaranteed over all recommended operating conditions.

Electrical Specifications ($V_{dd} = 8.0$ V, $V_{gg} = -1.0$ V, $T_A = 25$ °C)

Parameter	Min	Typ	Max	Min	Typ	Max	Units
Frequency Range	DC - 10			10 - 20			GHz
Gain	15.5	19		17	21		dB
Noise Figure		2			2.5		dB
Input Return Loss		17			15		dB
Output Return Loss		15			12		dB
Output P1dB	22	25		19	23		dBm
Output IP3		33			30		dBm
Supply Current	140	200	260	140	200	260	mA
Gain Temperature Coefficient		0.012			0.02		dB/°C
Noise Figure Temperature Coefficient		0.006			0.009		dB/°C

Typical Performance

Broadband Performance, $V_{dd} = 8.0\text{ V}$, $V_{gg} = -1.0\text{ V}$, $I_{dd} = 170\text{ mA}$, $T_A = 25\text{ }^\circ\text{C}$

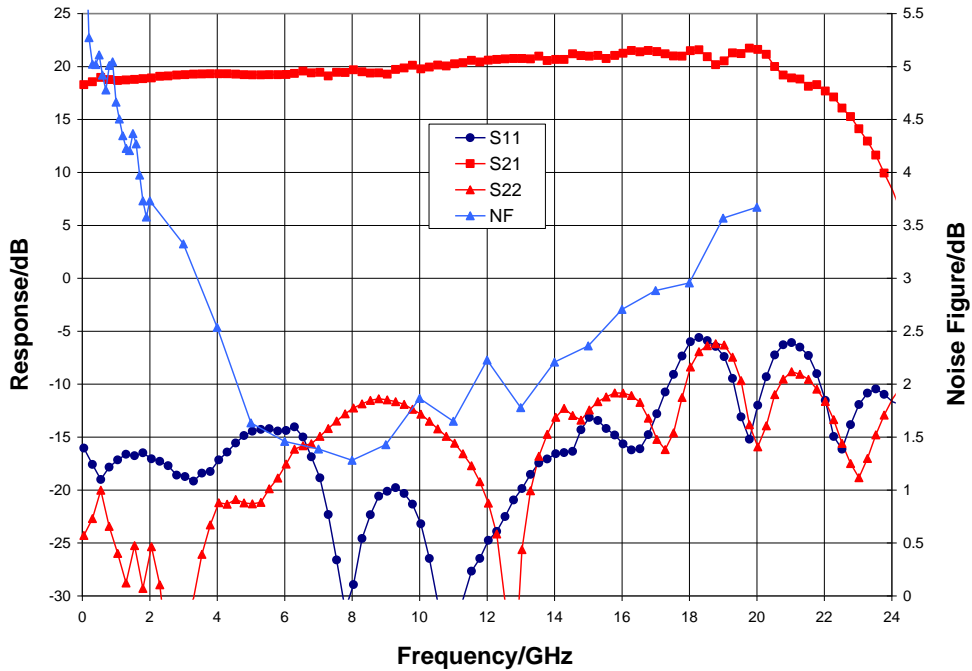

Narrow-band Performance, $V_{dd} = 8.0\text{ V}$, $V_{gg} = -1.0\text{ V}$, $I_{dd} = 170\text{ mA}$, $T_A = 25\text{ }^\circ\text{C}$

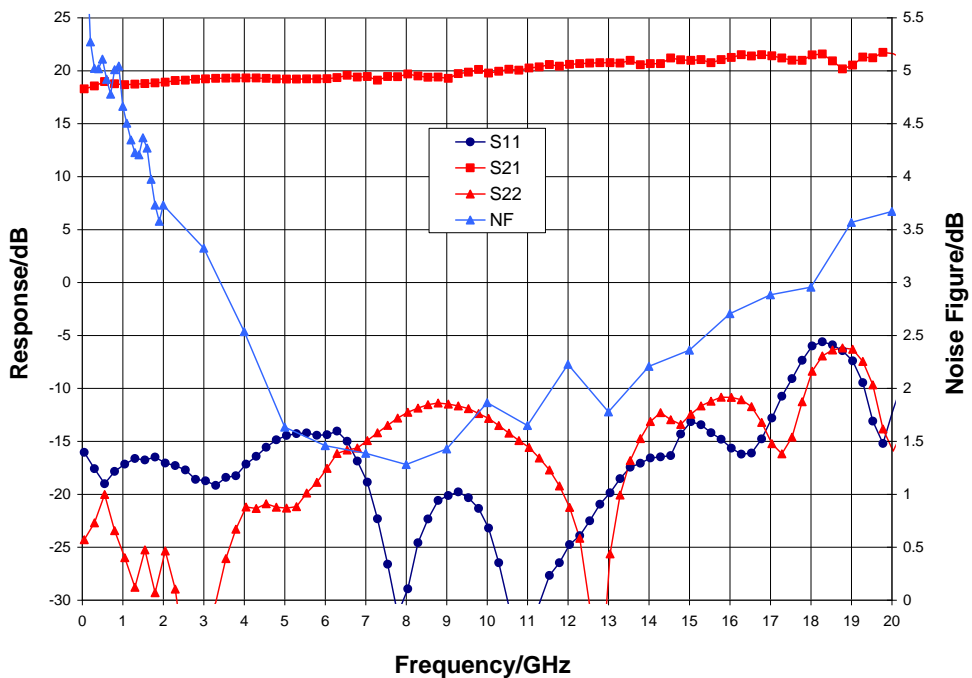

Typical Performance

Gain vs. Temperature, $V_{dd} = 8.0 \text{ V}$, $V_{gg} = -1.0 \text{ V}$

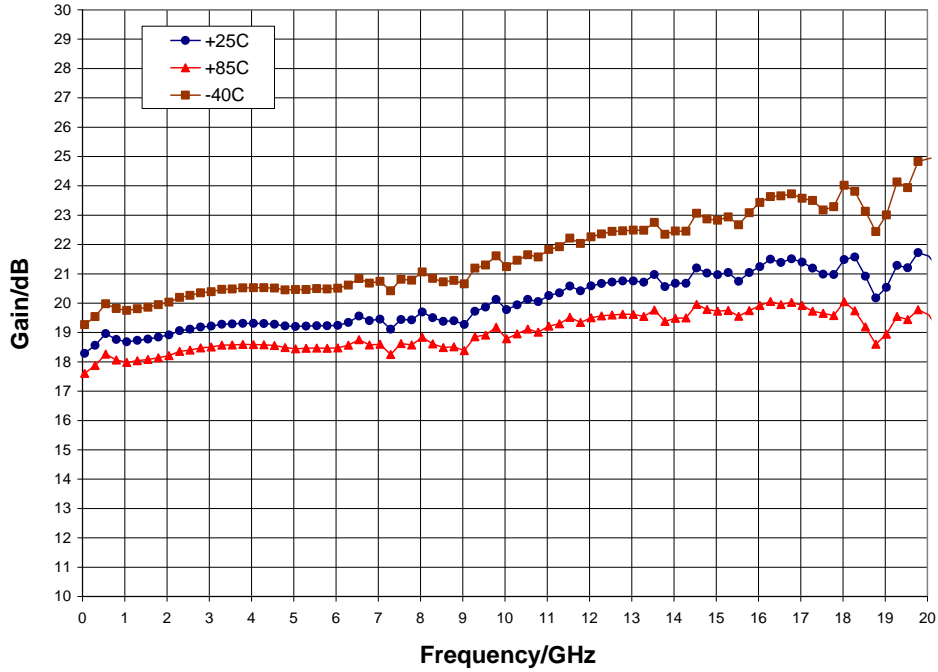

Noise Figure vs. Temperature, $V_{dd} = 8.0 \text{ V}$, $V_{gg} = -1.0 \text{ V}$

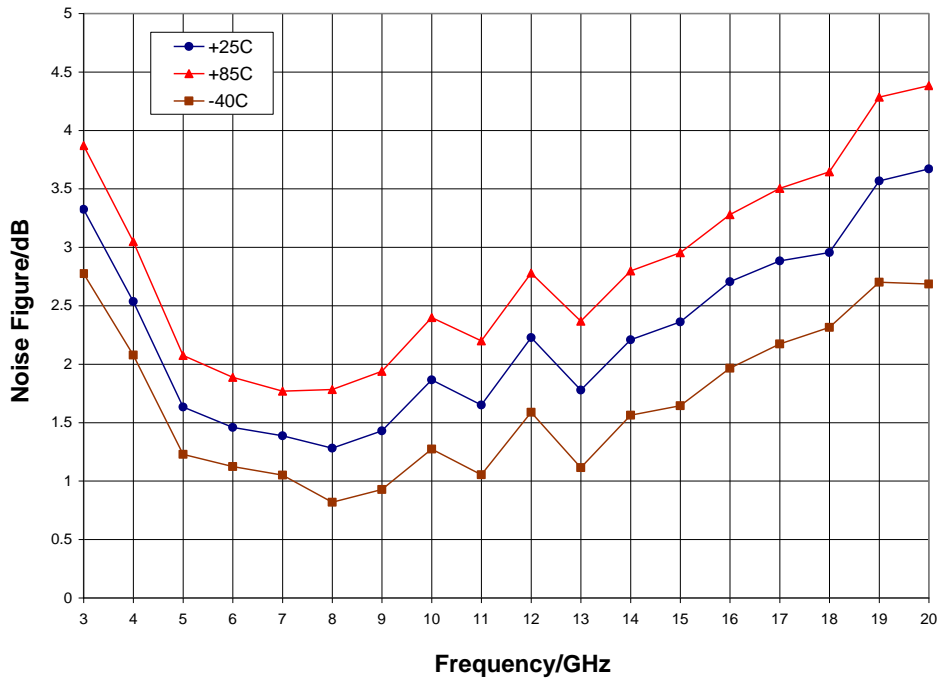

Typical Performance

Output Power, $V_{dd} = 8.0\text{ V}$, $V_{gg} = -1.0\text{ V}$, $T_A = 25\text{ }^\circ\text{C}$

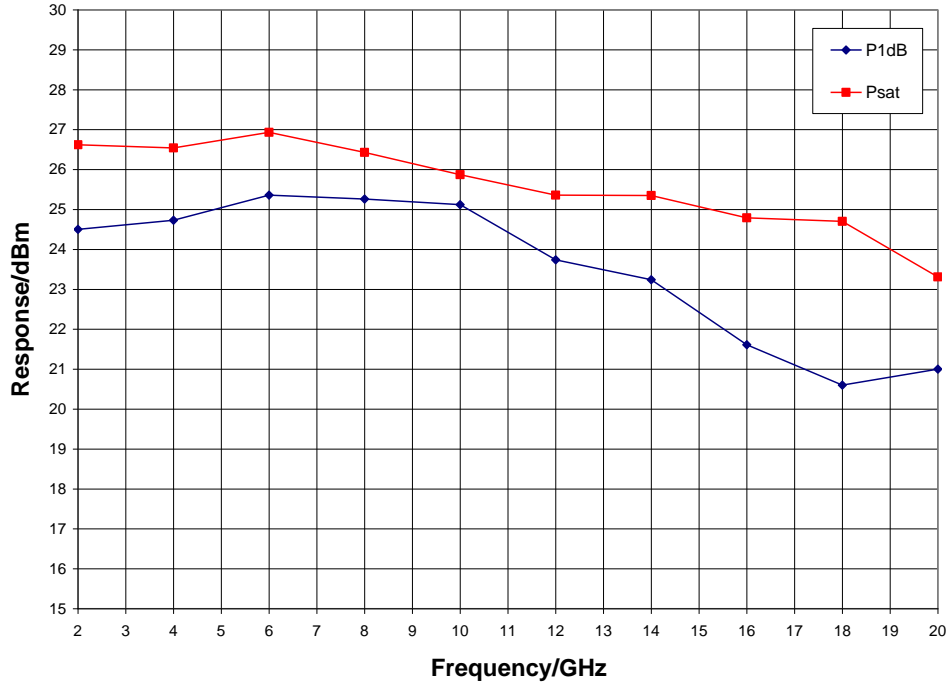

P1dB vs. Temperature, $V_{dd} = 8.0\text{ V}$, $V_{gg} = -1.0\text{ V}$

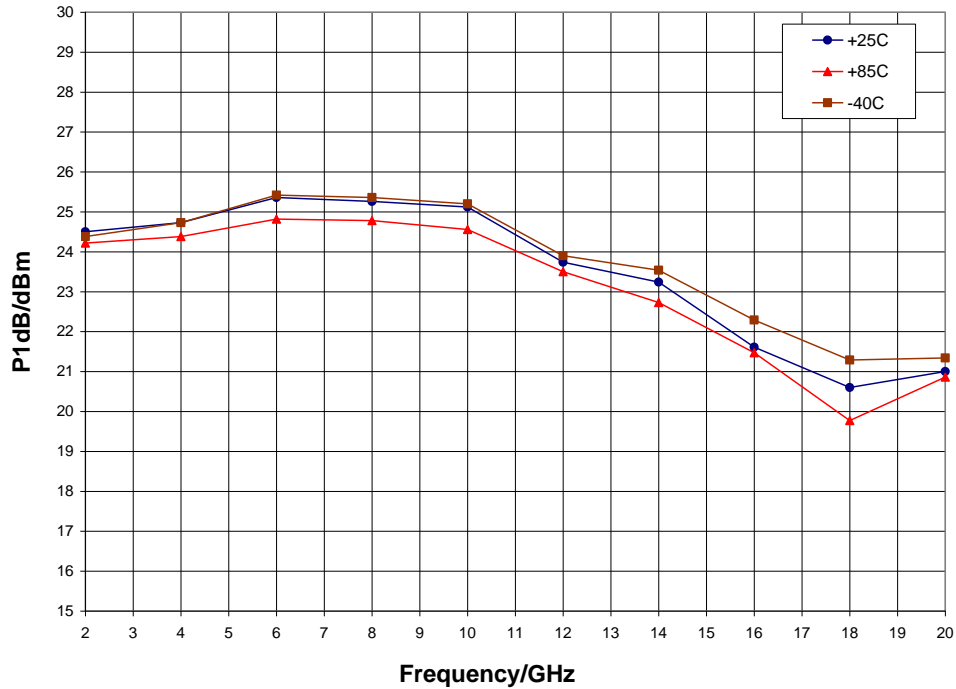

Typical Performance

Output IP3 vs. Temperature, $V_{dd} = 8.0\text{ V}$, $V_{gg} = -1.0\text{ V}$

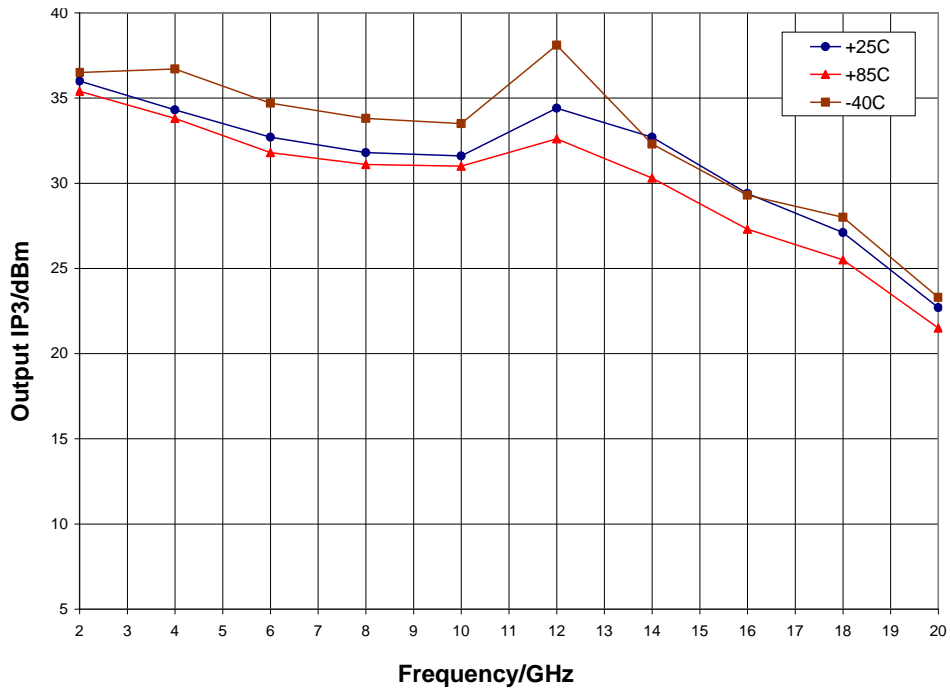

Gain control vs. V_{gg2} , $V_{dd} = 8.0\text{ V}$, $V_{gg} = -1.0\text{ V}$

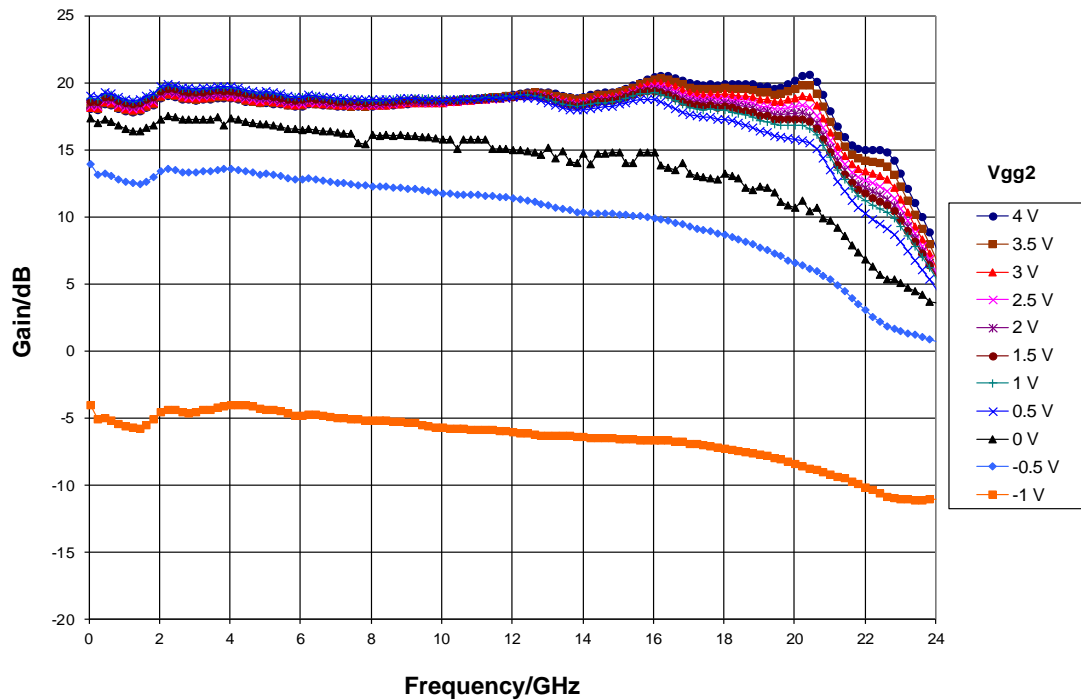

Mechanical Information

Package Information and Dimensions

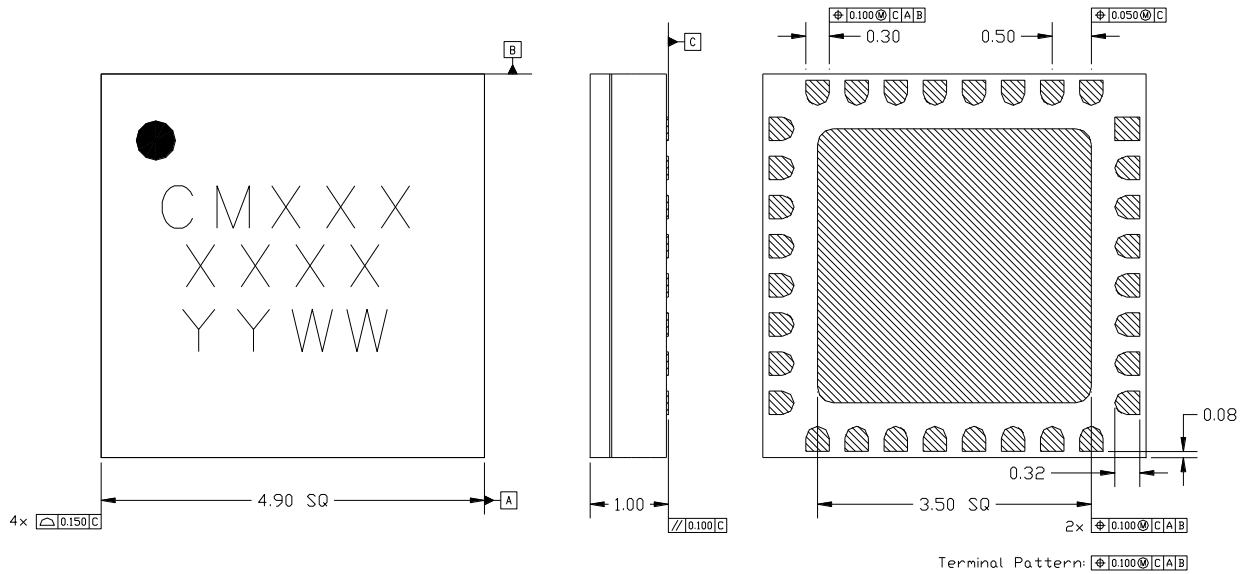

Notes:

1. All dimensions shown in mm.
2. Material: Black alumina
3. Lead finish:
 - 3.1. Ni: 8.89um max 1.27um min
 - 3.2. Pd: 0.17um max, 0.07um min
 - 3.3. Au: 0.254um max, 0.03um min
4. Marking
 - 4.1. Line 1: Part number
 - 4.1.1. Example: CMD192C5 shall be marked as CM192
 - 4.2. Line 2: Lot number
 - 4.3. Line 3: Date code - Last 2 digits of the year of manufacture followed by a 2 digit week code
5. Alternate pin #1 identifier is a single square pad
6. Alternate die paddle may have chamfered corners

Recommended PCB Land Pattern

Qorvo recommends that the user develop the land pattern that will provide the best design for proper solder reflow and device attach for their specific application. Please review Qorvo Application Note AN 105 for a recommended land pattern approach.

Recommended Solder Reflow Profile

Qorvo recommends screen printing with belt furnace reflow to ensure proper solder reflow and device attach. Please review Qorvo Application Note AN 102 for a recommended solder reflow profile.

Pad Description

Pin Diagram

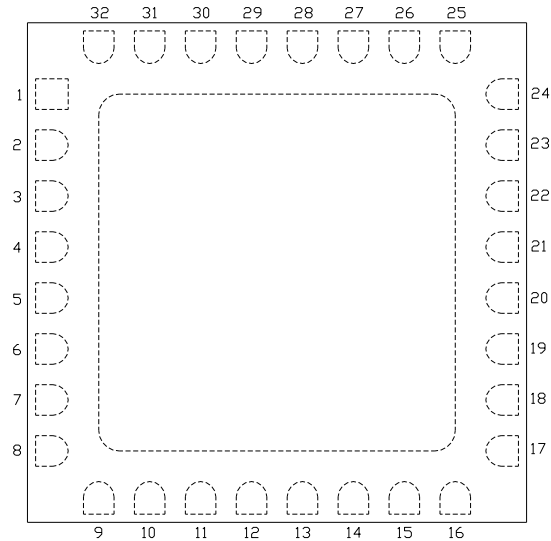

Functional Description

Pin	Function	Description	Schematic
1, 3, 4, 6 - 12, 14, 17 - 20, 22 - 28, 31, 32	N/C	No connection required These pins may be connected to RF / DC ground	
2	V_{gg2}	Optional supply voltage for gain control Decoupling and bypass caps required	
5	RF in	50 ohm matched input	
15, 16	ACG4, 3	Low frequency termination Attach bypass capacitor per application circuit	
13	V_{gg}	Power supply voltage Decoupling and bypass caps required	
21	RF out & V_{dd}	Power supply voltage and 50 ohm matched output	
29, 30	ACG2, 1	Low frequency termination Attach bypass capacitor per application circuit	
Die paddle	Ground	Connect to RF / DC ground	

Applications Information

Application Circuit

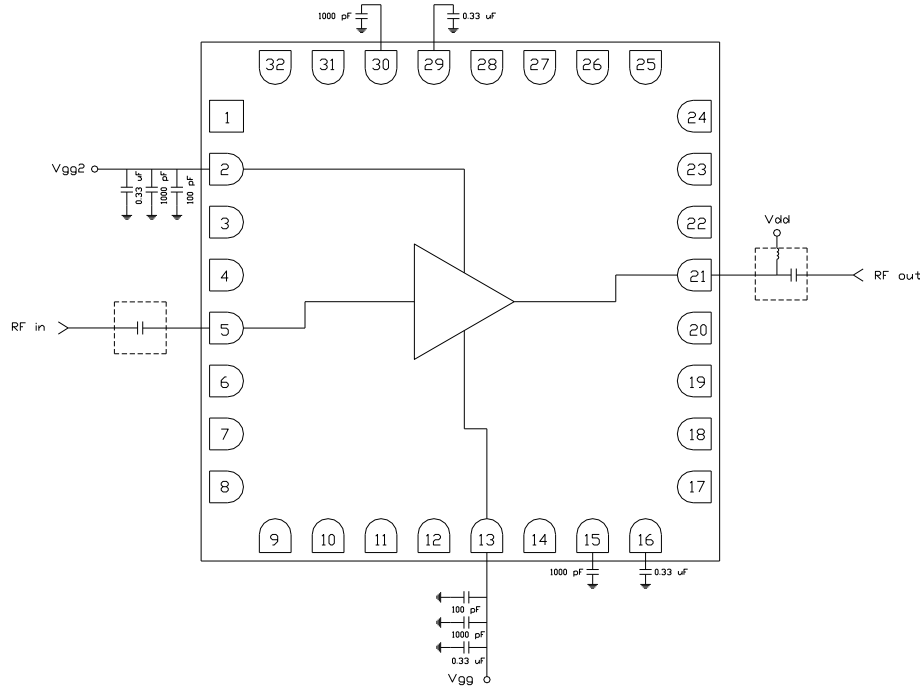

Biasing and Operation

The CMD192C5 is biased with a positive drain supply and negative gate supply. Performance is optimized when the drain voltage is set to +8.0 V. The recommended gate voltage is -1.0 V.

Turn ON procedure:

1. Apply gate voltage V_{gg} and set to -1 V
2. Apply drain voltage V_{dd} and set to +8 V

Turn OFF procedure:

1. Turn off drain voltage V_{dd}
2. Turn off gate voltage V_{gg}

RF power can be applied at any time.

GaAs MMIC devices are susceptible to damage from Electrostatic Discharge. Proper precautions should be observed during handling, assembly and test.

Applications Information

Evaluation Board

The circuit board shown has been developed for optimized assembly at Qorvo. A sufficient number of via holes should be used to connect the top and bottom ground planes. As surface mount processes vary, careful process development is recommended.

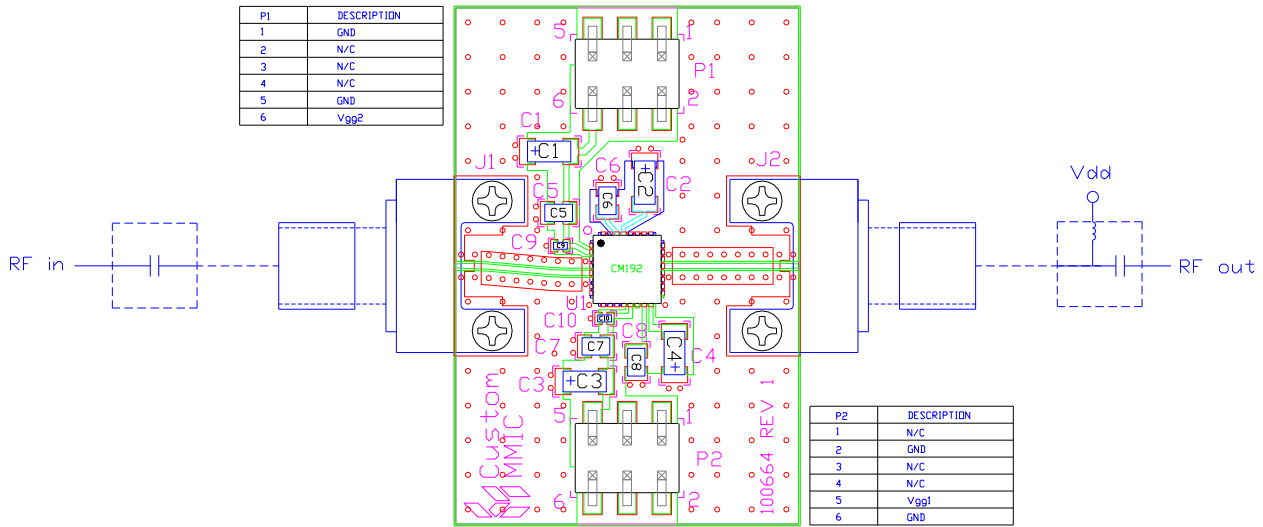

Designator	Value	Description
J1, J2		SMA End Launch Connector
P1, P2		6 Pin Header
C1 - C4	0.33 μ F	Capacitor, Tantalum
C5 - C8	1000 pF	Capacitor, 0603
C9, C10	100 pF	Capacitor, 0402
U1		CMD192C5 Driver Amplifier
PCB		100664 Evaluation PCB