

**NEW!**

MMIC

# REFLECTIONLESS FILTERS

50Ω DC to 21 GHz

## The Big Deal

- Patented design eliminates in band spurs
- Pass band cut-off up to 21 GHz
- Stop band up to 35 GHz
- Excellent repeatability through IPD\* process



**X-Series**

Available in Low Pass, High Pass and Band Pass designs

## Product Overview

Mini-Circuits' **X-Series** reflectionless filters employ a novel filter topology which absorbs and terminates stop band signals internally rather than reflecting them back to the source. This new capability enables unique applications for filter circuits beyond those suited to traditional approaches. Traditional filters are reflective in the stop band, sending signals back to the source at 100% of the power level which interact with neighboring components and often result in intermodulation and other interferences. Reflectionless filters eliminate stop band reflections, allowing them to be paired with sensitive devices and used in applications that otherwise require circuits such as isolation amplifiers or attenuators.

### Key Features

### Advantages

Easy integration with sensitive reflective components, e.g. mixers, multipliers	Reflectionless filters absorb unwanted signals, preventing reflections back to the source. This reduces generation of additional unwanted signals without the need for extra components like attenuators, improving system dynamic range and saving board space.
Enables stable integration of wideband amplifiers	Because reflectionless filters maintain good impedance in the stop band; they can be integrated with high gain, wideband amplifiers without the risk of creating instabilities in these out of band regions.
Cascadable	Reflectionless filters can be cascaded in multiple sections to provide sharper and higher attenuation, while also preventing any standing waves that could affect pass band signals.
Excellent power handling in a tiny surface mount device	High power handling extends the usability of these filters to the transmit path for inter-stage filtering.
Small size, 3x3mm QFN	Allows replacement of filter/attenuator pairs with a single reflectionless filter, saving board space.
Excellent repeatability of RF performance	Through semiconductor IPD process, X-series filters are inherently repeatable for large volume production.
Excellent stability over temperature	With $\pm 0.3$ dB variation over temperature ideal for use in wide temperature range applications without the need for additional temperature compensation.
Operating temperature up to 105°C	Suitable for operation close to high power components.

\*IPD – Integrated Passive Device, is a GaAs semiconductor process



# Reflectionless Low Pass Filter

## XLF-173+

50Ω DC to 17000 MHz

### Features

- Match to 50Ω in the stop band, eliminates undesired reflections
- Cascadable
- Excellent Power handling
- Temperature stable, up to 105°C
- Small size, 3 x 3 mm
- Protected by US Patent No. 8,392,495

### Applications

- Harmonics Rejection
- Satellite
- Radar
- Military & Space

### General Description

Mini-Circuits' XLF-173+ reflectionless filter employs a novel filter topology which absorbs and terminates stop band signals internally rather than reflecting them back to the source. This new capability enables unique applications for filter circuits beyond those suited to traditional approaches. Traditional filters are reflective in the stop band, sending signals back to the source at 100% of the power level. These reflections interact with neighboring components and often result in inter-modulation and other interferences. Reflectionless filters eliminate stop band reflections, allowing them to be paired with sensitive devices and used in applications that otherwise require circuits such as isolation amplifiers or attenuators.

### simplified schematic and pad description

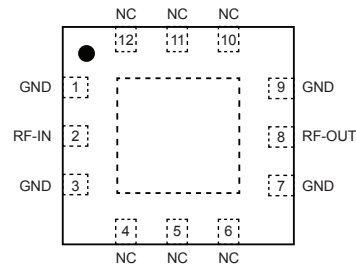
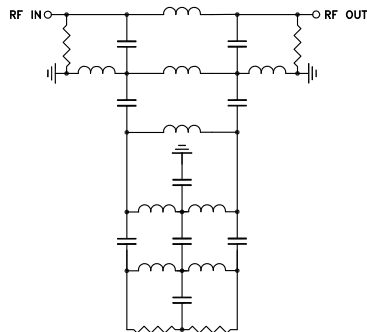

Function	Pad Number	Description
RF-IN	2	RF Input Pad
RF-OUT	8	RF Output Pad
GND	1,3,7,9, Paddle	Connected to ground
NC (GND Externally)	4,5,6,10,11,12	No internal connection

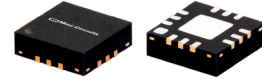

Generic photo used for illustration purposes only

CASE STYLE: DQ1225

### +RoHS Compliant

The +Suffix identifies RoHS Compliance. See our web site for RoHS Compliance methodologies and qualifications



Available Tape and Reel  
at no extra cost

Reel Size	Devices/Reel
7"	20, 50, 100, 200, 500, 1000, 2000

**Electrical Specifications<sup>1</sup> at 25°C**

Parameter		F#	Frequency (MHz)	Min.	Typ.	Max.	Unit
Pass Band	Insertion Loss	DC - F1	DC-17000	—	2.3	3.4	dB
	Frequency Cut-off	F2	18000	—	3.0	—	dB
	VSWR	DC - F1	DC-17000	—	1.2	—	:1
Stop Band	Rejection	F3 - F4	23900 - 26000	14	17	—	dB
		F4 - F5	26000 - 33000	18	21	—	dB
	VSWR	F3 - F4	23900 - 26000	—	2.6	—	:1
		F4 - F5	26000 - 33000	—	3	—	:1

<sup>1</sup> Measured on Mini-Circuits Characterization Test Board TB-844-173+

**Absolute Maximum Ratings<sup>4</sup>**

Parameter	Ratings
Operating Temperature	-55°C to +105°C
Storage Temperature	-65°C to +150°C
RF Power Input, Passband (DC-F1) <sup>2</sup>	2W at 25°C
RF Power Input, Stopband (F2-F5) <sup>3</sup>	30mW at 25°C

<sup>2</sup> Passband rating derates linearly to 1W at 105°C ambient

<sup>3</sup> Stopband rating derates linearly to 15mW at 105°C ambient

<sup>4</sup> Permanent damage may occur if any of these limits are exceeded.

**Specification Definition**

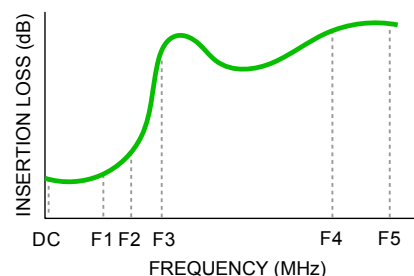

**ESD rating**

Human body model (HBM): Class 1A (250 to <500V) in accordance with ANSI/ESD 5.1-2001

**MSL rating**

Moisture Sensitivity: MSL1 in accordance with IPC/JEDEC J-STD-020D

**Typical Performance Data at 25°C**

Frequency (MHz)	Insertion Loss (dB)	VSWR (:1)
10	0.49	1.04
100	0.49	1.01
400	0.54	1.05
800	0.56	1.09
1600	0.57	1.14
3000	0.52	1.07
5000	0.60	1.11
7000	0.83	1.06
9000	1.03	1.04
11000	1.27	1.24
13000	1.47	1.21
15000	1.67	1.12
17000	2.24	1.48
18000	3.07	2.08
21000	5.62	1.87
23900	18.50	1.71
26000	50.38	3.14
28000	27.85	2.68
31000	21.48	2.68
33000	27.29	5.62

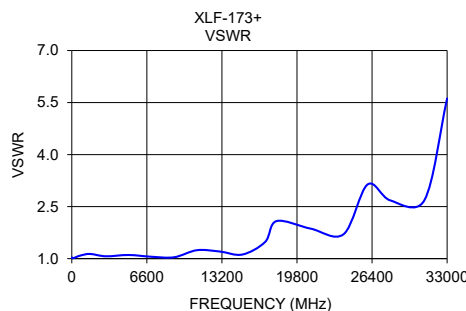
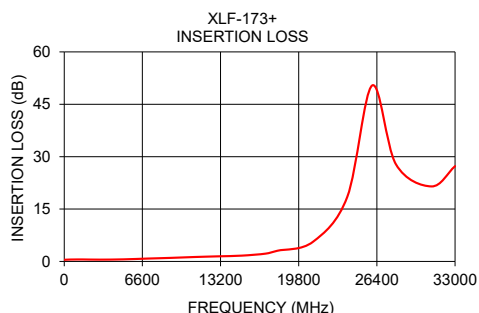

**Outline Drawing**

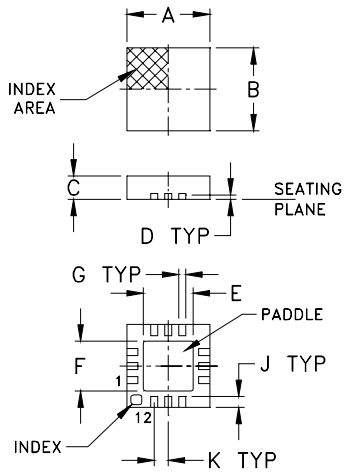



**PCB Land Pattern**



**Demo Board MCL P/N:**  
**TB-844-173+** (without connectors)  
**TB-844-173C+** (with connectors)  
**B20-118-F1+** Connector sold separately  
**Suggested PCB Layout: PL-451+**



- NOTES:**  
 1. TRACE WIDTH PARAMETERS ARE SHOWN FOR ROGERS RO4350B WITH DIELECTRIC THICKNESS .0066"±.0007". COPPER: 1/2 OZ. EACH SIDE. FOR OTHER MATERIALS TRACE WIDTH AND GAP MAY NEED TO BE MODIFIED.  
 2. BOTTOM SIDE OF THE PCB IS CONTINUOUS GROUND PLANE.  
 DENOTES PCB COPPER LAYOUT WITH SMOBC (SOLDER MASK OVER BARE COPPER).  
 DENOTES COPPER LAND PATTERN FREE OF SOLDER MASK.

**Outline Dimensions ( inch / mm )**

A	B	C	D	E	F	G	H	J
.118	.118	.035	.008	.057	.057	.009	---	.016
3.00	3.00	0.89	0.20	1.45	1.45	0.23	---	0.41
K	L	M	N	P	Q	R		wt
.020	.127	.127	.049	.010	.020	.049		grams
0.51	3.23	3.23	1.24	0.25	0.51	1.24		0.02

**Tape & Reel Packaging**

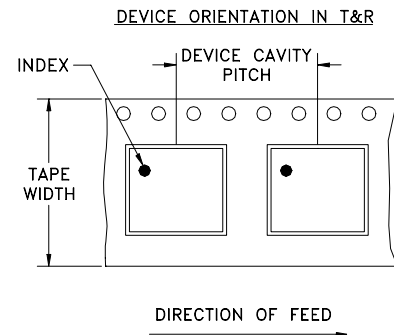

**Product Marking**

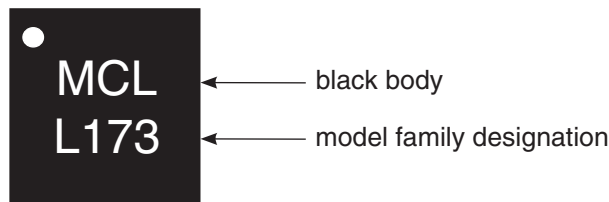

Tape Width, mm	Device Cavity Pitch, mm	Reel Size, inches	Devices per Reel see note	
8	4	7	Small quantity standard	20
				50
		100		
		200		
		500		
		7	Standard	1000, 2000