

FEATURES

Passive, wideband I/Q mixer
RF and LO range: 6 GHz to 26.5 GHz
Wide IF bandwidth of dc to 5 GHz
Single-ended RF, LO, and IF
Conversion loss: 9 dB (typical)
Image rejection: 25 dBc (typical)
Single-sideband noise figure: 9 dB (typical)
Input IP3 (downconverter): 24 dBm (typical)
Input P1dB compression point (downconverter): 15 dBm (typical)
Input IP2: 55 dBm (typical)
LO to RF isolation: 40 dB (typical)
LO to IF isolation: 40 dB (typical)
RF to IF isolation: 20 dB (typical)
Amplitude balance: ± 0.5 dB (typical)
Phase balance (downconverter): $\pm 5^\circ$ (typical)
RF return loss: 15 dB (typical)
LO return loss: 15 dB (typical)
IF return loss: 15 dB (typical)
Exposed pad, 4 mm \times 4 mm, 24-terminal, ceramic, LCC package

APPLICATIONS

Test and measurement instrumentation
Military, aerospace, and defense applications
Microwave point to point base stations

GENERAL DESCRIPTION

The HMC8191 is a passive, wideband, I/Q monolithic microwave integrated circuit (MMIC) mixer that can be used either as an image reject mixer for receiver operations or as a single-sideband upconverter for transmitter operations. With a radio frequency (RF) and local oscillator (LO) range of 6 GHz to 26.5 GHz, and an intermediate frequency (IF) bandwidth of dc to 5 GHz, the HMC8191 is ideal for applications requiring a wide frequency range, excellent RF performance, and a simple design with fewer components and a small printed circuit board (PCB) footprint. A single HMC8191 can replace multiple narrow-band mixers in a design.

The inherent I/Q architecture of the HMC8191 offers excellent image rejection and thereby eliminates the need for expensive filtering for unwanted sidebands. The mixer also provides

FUNCTIONAL BLOCK DIAGRAM

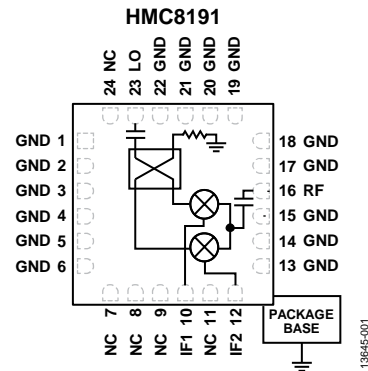

Figure 1.

excellent LO to RF and LO to IF isolation and reduces the effect of LO leakage to ensure signal integrity.

Being a passive mixer, the HMC8191 does not require any dc power sources. It offers a lower noise figure compared to an active mixer, ensuring superior dynamic range for high performance and precision applications.

The HMC8191 is fabricated on a gallium arsenide (GaAs) metal semiconductor field effect transistor (MESFET) process and uses Analog Devices, Inc. mixer cells and a 90-degree hybrid. The HMC8191 is available in a compact, 4 mm \times 4 mm, 24-terminal leadless chip carrier (LCC) package and operates over a -40°C to $+85^\circ\text{C}$ temperature range. An evaluation board for the HMC8191 is also available from the Analog Devices website.

TABLE OF CONTENTS

Features	1	Upconverter Performance: IF = 2500 MHz, Lower Sideband (High-Side LO)	20
Applications	1	Upconverter Performance: IF = 5000 MHz, Lower Sideband (High-Side LO)	22
Functional Block Diagram	1	Upconverter Performance: IF = 100 MHz, Upper Sideband (Low-Side LO)	24
General Description	1	Upconverter Performance: IF = 2500 MHz, Upper Sideband (Low-Side LO)	26
Revision History	2	Upconverter Performance: IF = 5000 MHz, Upper Sideband (Low-Side LO)	28
Specifications	3	Isolation and Return Loss	30
Absolute Maximum Ratings	4	IF Bandwidth Performance: Downconverter, Lower Sideband (High-Side LO)	32
Thermal Resistance	4	Amplitude and Phase Imbalance Performance: Downconverter, Lower Sideband (High-Side LO)	33
ESD Caution	4	Amplitude and Phase Imbalance Performance: Downconverter, Upper Sideband (Low-Side LO)	35
Pin Configuration and Function Descriptions	5	Spurious and Harmonics Performance	37
Interface Schematics	5	Theory of Operation	40
Typical Performance Characteristics	6	Applications Information	41
Downconverter Performance: IF = 100 MHz, Lower Sideband (High-Side LO)	6	RF and LO Performance Above 26 GHz	42
Downconverter Performance: IF = 2500 MHz, Lower Sideband (High-Side LO)	8	IF Bandwidth Above 5 GHz	42
Downconverter Performance: IF = 5000 MHz, Lower Sideband (High-Side LO)	10	Soldering Information and Recommended Land Pattern	43
Downconverter Performance: IF = 100 MHz, Upper Sideband (Low-Side LO)	12	Evaluation Board Information	43
Downconverter Performance: IF = 2500 MHz, Upper Sideband (Low-Side LO)	14	Outline Dimensions	44
Downconverter Performance: IF = 5000 MHz, Upper Sideband (Low-Side LO)	16	Ordering Guide	44
Upconverter Performance: IF = 100 MHz, Lower Sideband (High-Side LO)	18		

REVISION HISTORY

8/2019—Rev. B to Rev. C	
Changes to Table 4, Figure 5, and Figure 6	5
Changes to Ordering Guide	44
5/2018—Rev. A to Rev. B	
Changes to Applications Information Section	41
2/2018—Rev. 0 to Rev. A	
Change to Features Section	1
Change to Single-Sideband Noise Figure Parameter, Table 1	3
Deleted Figure 13 and Figure 16; Renumbered Sequentially	7
Deleted Figure 25 and Figure 28	9
Deleted Figure 47 and Figure 50	13
Deleted Figure 59 and Figure 62	15
Changes to Ordering Guide	44
6/2017—Revision 0: Initial Version	

SPECIFICATIONS

$T_A = 25^\circ\text{C}$, IF = 100 MHz, LO drive = 18 dBm, all measurements performed as downconverter with lower sideband selected, external 90° hybrid at the IF ports, and LO amplifier in line with lab bench LO source, unless otherwise noted.

Table 1.

Parameter	Symbol	Min	Typ	Max	Unit
RADIO FREQUENCY	RF	6		26.5	GHz
LOCAL OSCILLATOR FREQUENCY	f_{LO}	6		26.5	GHz
INTERMEDIATE FREQUENCY	IF	DC		5	GHz
LOCAL OSCILLATOR DRIVE LEVEL			18		dBm
RF PERFORMANCE AS DOWNCONVERTER					
Conversion Loss			9	11.5	dB
Image Rejection		20	25		dBc
Single-Sideband Noise Figure	SSB NF		9		dB
Input Third-Order Intercept	IP3		24		dBm
Input 1 dB Compression Point	P1dB		15		dBm
Input Second-Order Intercept	IP2		55		dBm
Isolation					
RF to IF			20		dB
LO to RF		30	40		dB
LO to IF		27	40		dB
Amplitude Balance ¹			± 0.5		dB
Phase Balance ¹			± 5		Degrees
RF PERFORMANCE AS UPCONVERTER					
Conversion Loss			9		dB
Sideband Rejection			25		dBc
Input Third-Order Intercept	IP3		22		dBm
Input 1 dB Compression Point	P1dB		13		dBm
RETURN LOSS PERFORMANCE ¹					
RF			15		dB
LO			15		dB
IFx			15		dB

¹ Measurements taken without 90° hybrid at the IF ports.

ABSOLUTE MAXIMUM RATINGS

Table 2.

Parameter	Rating
RF Input Power	24 dBm
LO Input Power	24 dBm
IF Input Power	24 dBm
IF Source/Sink Current	3 mA
Continuous Power Dissipation, P_{DISS} ($T_A = 85^\circ\text{C}$, Derate 7.29 mW/ $^\circ\text{C}$ Above 85°C)	657 mW
Maximum Junction Temperature	175°C
Maximum Peak Reflow Temperature (MLS3)	260°C
Operating Temperature Range	-40°C to $+85^\circ\text{C}$
Storage Temperature Range	-65°C to $+150^\circ\text{C}$
Electrostatic Discharge Sensitivity	
Human Body Model	750 V
Field Induced Charged Device Model	1200 V

Stresses at or above those listed under Absolute Maximum Ratings may cause permanent damage to the product. This is a stress rating only; functional operation of the product at these or any other conditions above those indicated in the operational section of this specification is not implied. Operation beyond the maximum operating conditions for extended periods may affect product reliability.

THERMAL RESISTANCE

Thermal performance is directly linked to PCB design and operating environment. Careful attention to PCB thermal design is required.

Table 3. Thermal Resistance

Package Type	θ_{JA}	θ_{JC}	Unit
E-24-1 ¹	38.3	137	$^\circ\text{C}/\text{W}$

¹ Refer to JEDEC standard JESD51-2 for additional information on optimizing the thermal impedance (PCB with 4×4 vias).

ESD CAUTION



ESD (electrostatic discharge) sensitive device. Charged devices and circuit boards can discharge without detection. Although this product features patented or proprietary protection circuitry, damage may occur on devices subjected to high energy ESD. Therefore, proper ESD precautions should be taken to avoid performance degradation or loss of functionality.

PIN CONFIGURATION AND FUNCTION DESCRIPTIONS

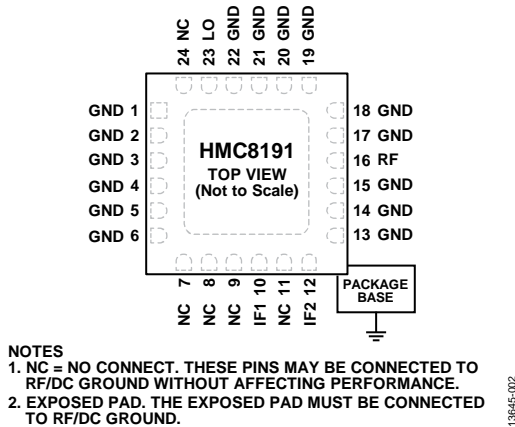

Figure 2. Pin Configuration

Table 4. Pin Function Descriptions

Pin No.	Mnemonic	Description
1 to 6, 13 to 15, 17 to 22	GND	Ground. These pins and the package bottom must be connected to RF/dc ground. See Figure 3 for the interface schematic.
7 to 9, 11, 24	NC	No Connect. These pins can be connected to RF/dc ground without affecting performance.
10, 12	IF1, IF2	First and Second Quadrature Intermediate Frequency Input/Output Pins. These pins are dc-coupled. For applications not requiring operation to dc, use an off-chip dc blocking capacitor. For operations to dc, these pins must not source/sink more than 3 mA of current; otherwise, the device may not function and may fail. See Figure 4 for the interface schematic.
16	RF	Radio Frequency Input/Output. This pin is dc-coupled and matched to 50 Ω when the LO is turned on. See Figure 5 for the interface schematic.
23	LO	Local Oscillator Input. This pin is dc-coupled and matched to 50 Ω when the LO is turned on. See Figure 6 for the interface schematic.
	EPAD	Exposed Pad. The exposed pad must be connected to RF/dc ground.

INTERFACE SCHEMATICS



Figure 3. GND Interface Schematic

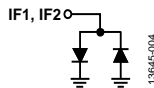

Figure 4. IF1 and IF2 Interface Schematic

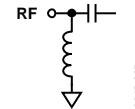

Figure 5. RF Interface Schematic

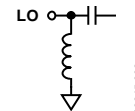

Figure 6. LO Interface Schematic

TYPICAL PERFORMANCE CHARACTERISTICS

DOWNCONVERTER PERFORMANCE: IF = 100 MHz, LOWER SIDEBAND (HIGH-SIDE LO)

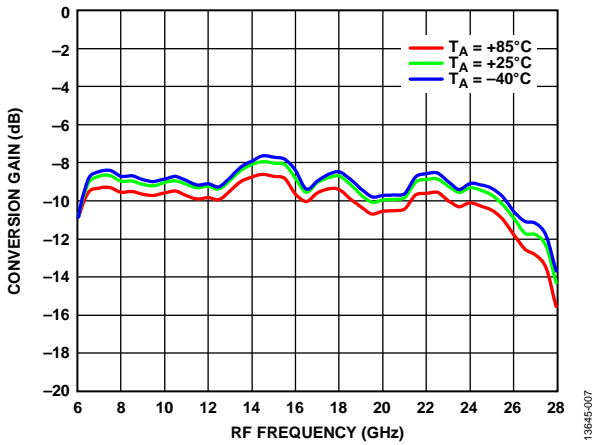

Figure 7. Conversion Gain vs. RF Frequency at Various Temperatures, LO Drive = 18 dBm

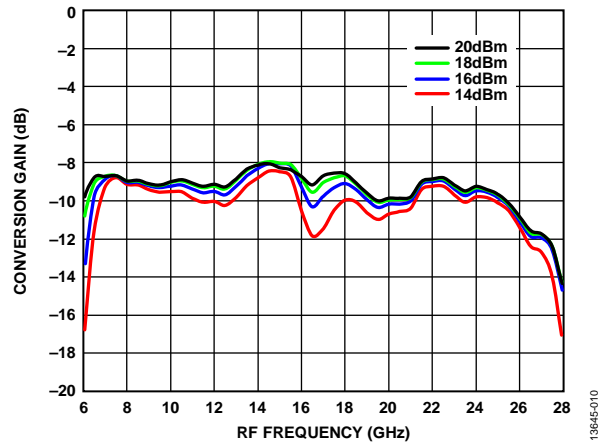

Figure 10. Conversion Gain vs. RF Frequency at Various LO Drives, $T_A = 25^\circ\text{C}$

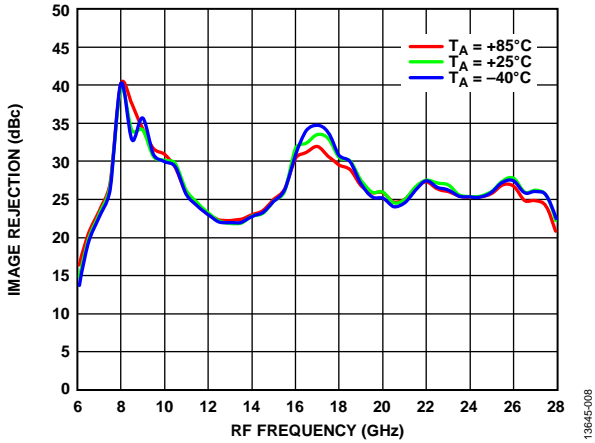

Figure 8. Image Rejection vs. RF Frequency at Various Temperatures, LO Drive = 18 dBm

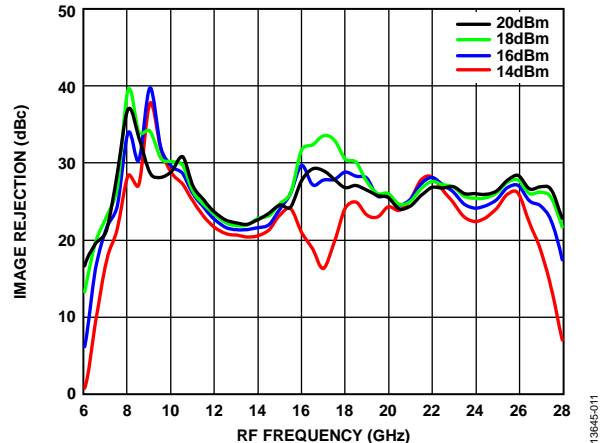

Figure 11. Image Rejection vs. RF Frequency at Various LO Drives, $T_A = 25^\circ\text{C}$

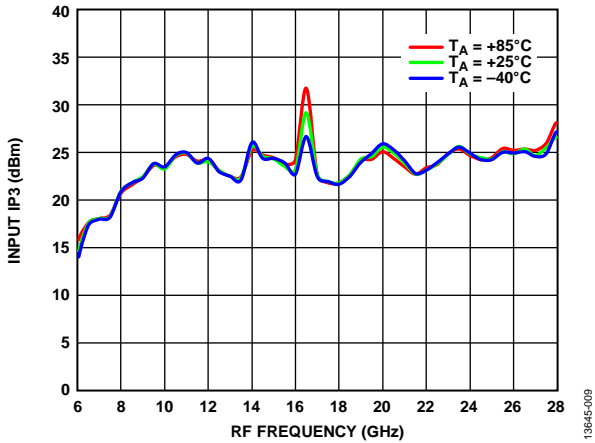

Figure 9. Input IP3 vs. RF Frequency at Various Temperatures, LO Drive = 18 dBm

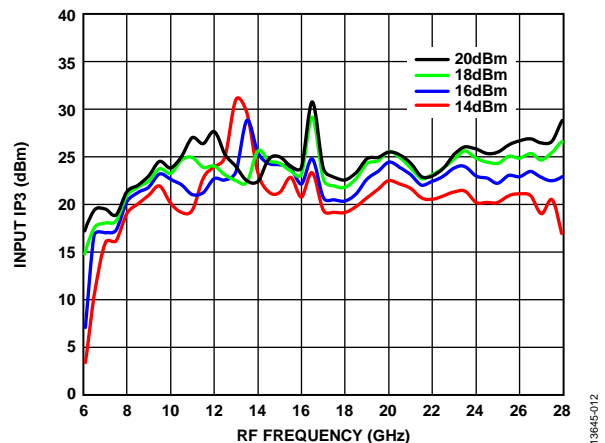

Figure 12. Input IP3 vs. RF Frequency at Various LO Drives, $T_A = 25^\circ\text{C}$

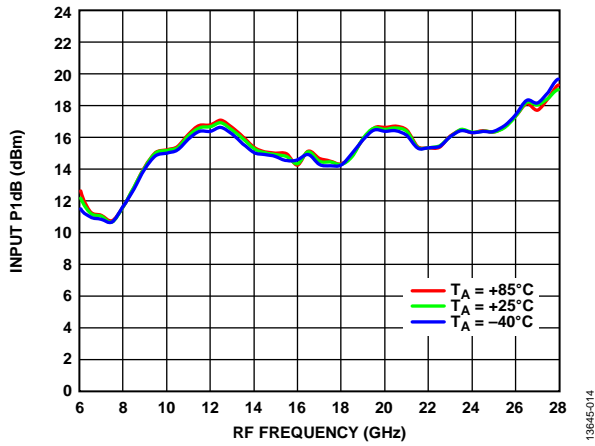

Figure 13. Input P1dB vs. RF Frequency at Various Temperatures, LO Drive = 18 dBm

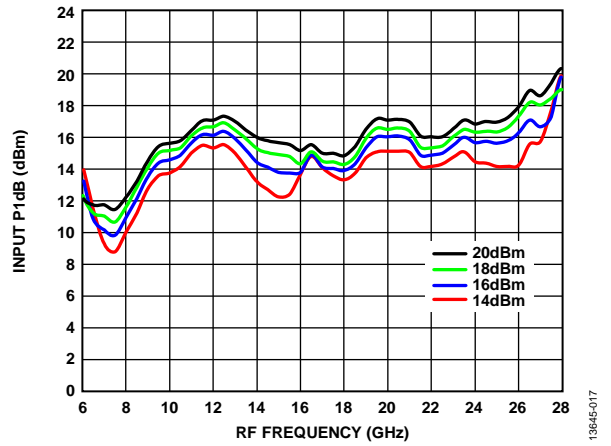

Figure 15. Input P1dB vs. RF Frequency at Various LO Drives, $T_A = 25^\circ\text{C}$

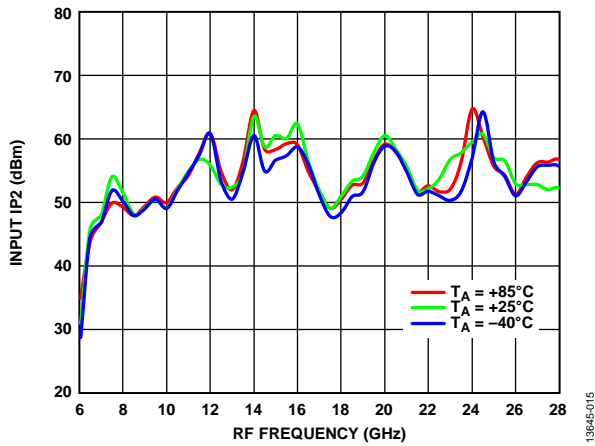

Figure 14. Input IP2 vs. RF Frequency at Various Temperatures, LO Drive = 18 dBm

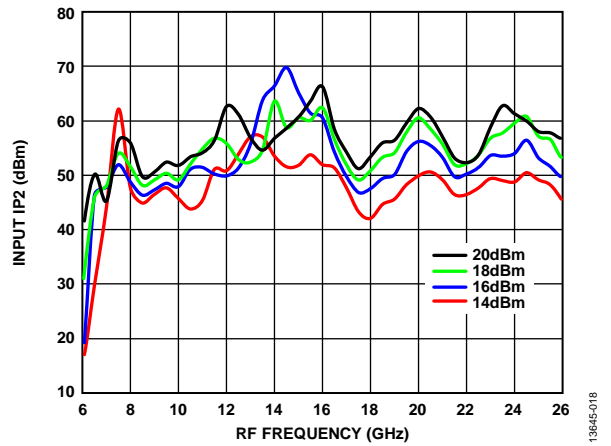

Figure 16. Input IP2 vs. RF Frequency at Various LO Drives, $T_A = 25^\circ\text{C}$

DOWNCONVERTER PERFORMANCE: IF = 2500 MHz, LOWER SIDEBAND (HIGH-SIDE LO)

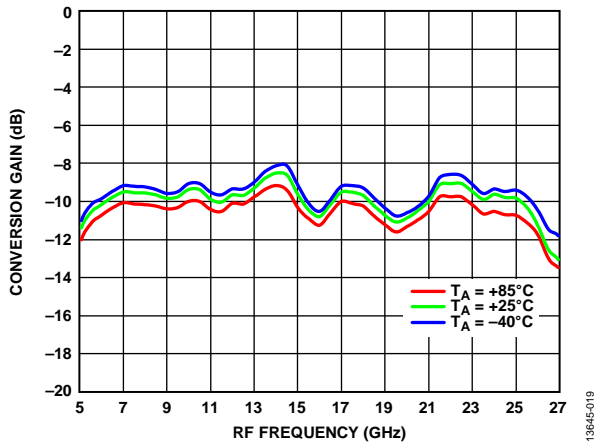

Figure 17. Conversion Gain vs. RF Frequency at Various Temperatures, LO Drive = 18 dBm

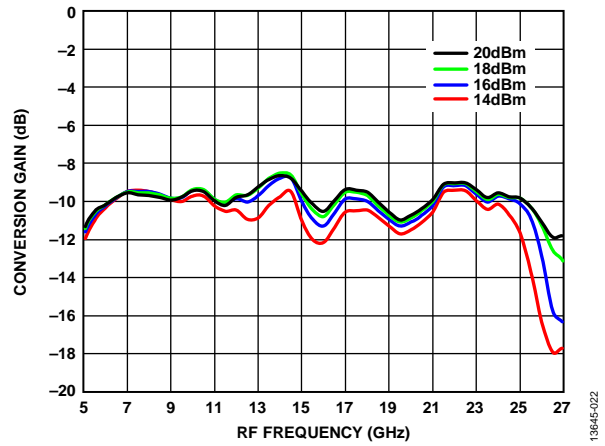

Figure 20. Conversion Gain vs. RF Frequency at Various LO Drives, $T_A = 25^\circ\text{C}$

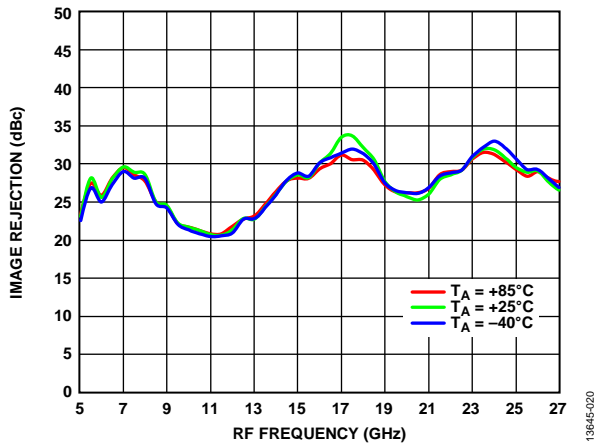

Figure 18. Image Rejection vs. RF Frequency at Various Temperatures, LO Drive = 18 dBm

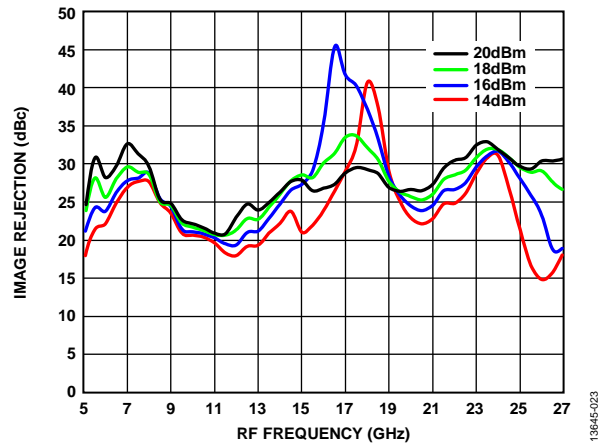

Figure 21. Image Rejection vs. RF Frequency at Various LO Drives, $T_A = 25^\circ\text{C}$

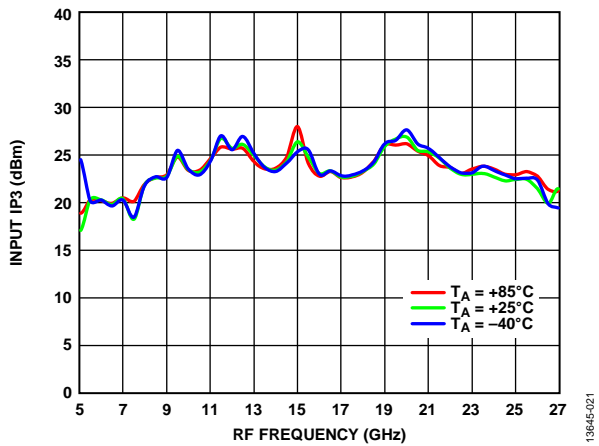

Figure 19. Input IP3 vs. RF Frequency at Various Temperatures, LO Drive = 18 dBm

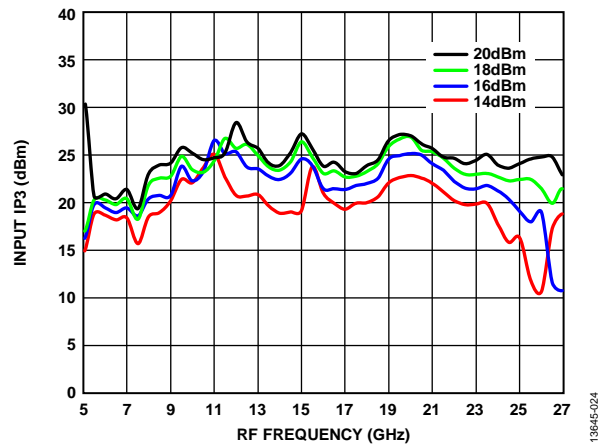

Figure 22. Input IP3 vs. RF Frequency at Various LO Drives, $T_A = 25^\circ\text{C}$

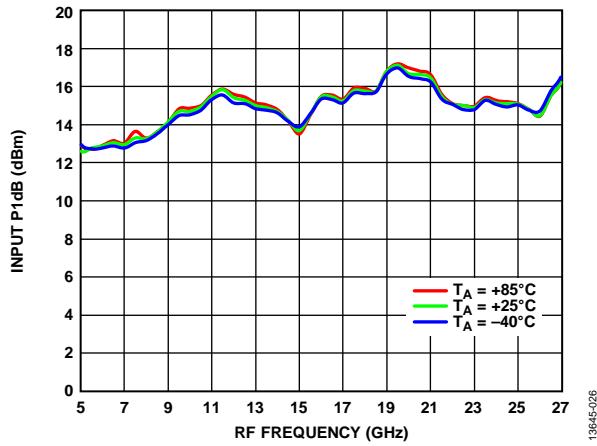

Figure 23. Input P1dB vs. RF Frequency at Various Temperatures, LO Drive = 18 dBm

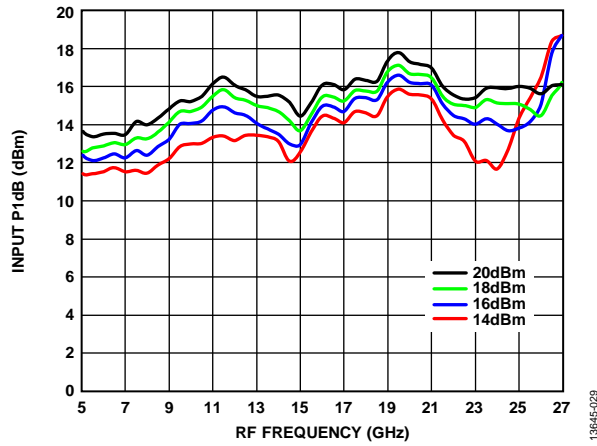

Figure 25. Input P1dB vs. RF Frequency at Various LO Drives, $T_A = 25^\circ\text{C}$

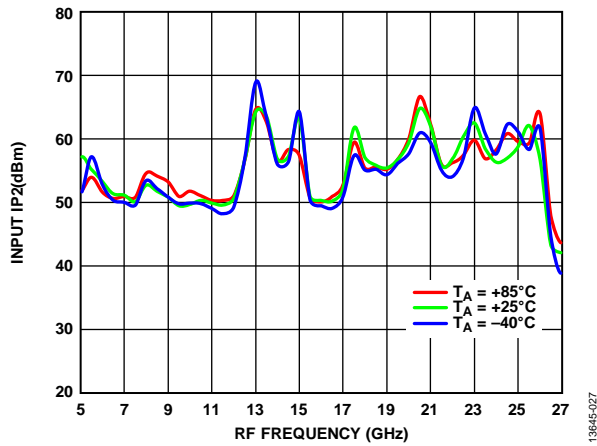

Figure 24. Input IP2 vs. RF Frequency at Various Temperatures, LO Drive = 18 dBm

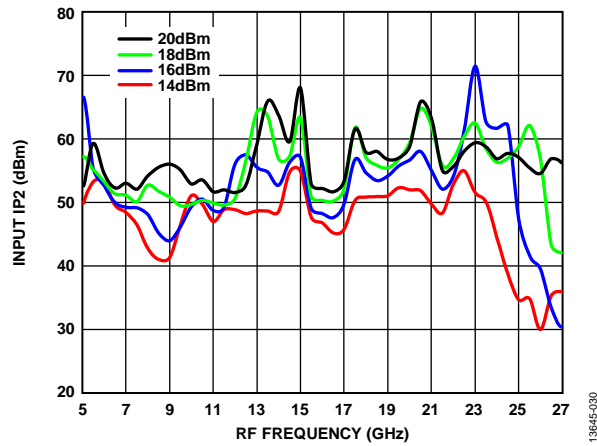

Figure 26. Input IP2 vs. RF Frequency at Various LO Drives, $T_A = 25^\circ\text{C}$

13845-026

13845-029

13845-027

13845-030

DOWNCONVERTER PERFORMANCE: IF = 5000 MHz, LOWER SIDEBAND (HIGH-SIDE LO)

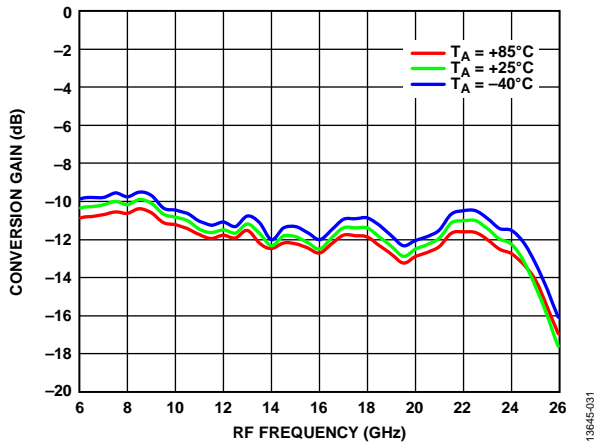

Figure 27. Conversion Gain vs. RF Frequency at Various Temperatures, LO Drive = 18 dBm

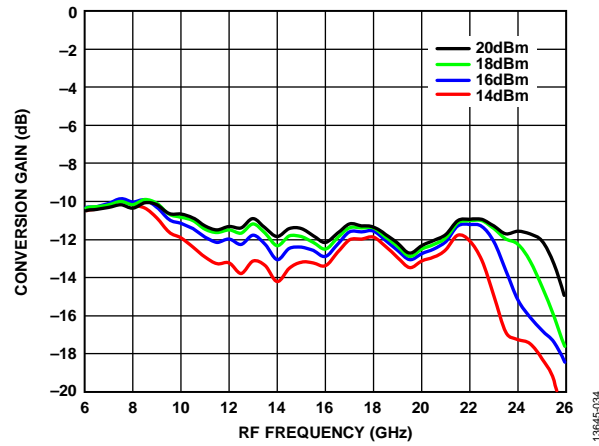

Figure 30. Conversion Gain vs. RF Frequency at Various LO Drives, $T_A = 25^\circ\text{C}$

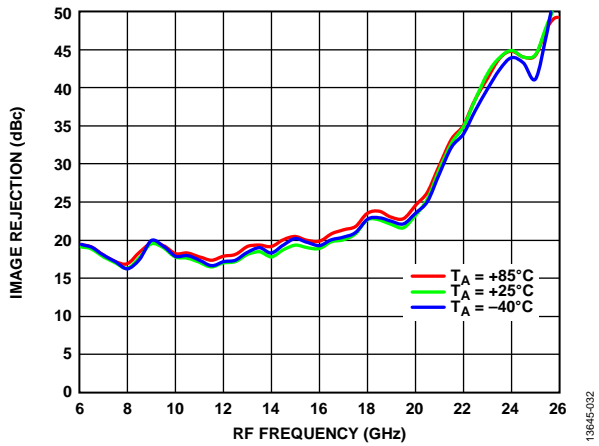

Figure 28. Image Rejection vs. RF Frequency at Various Temperatures, LO Drive = 18 dBm

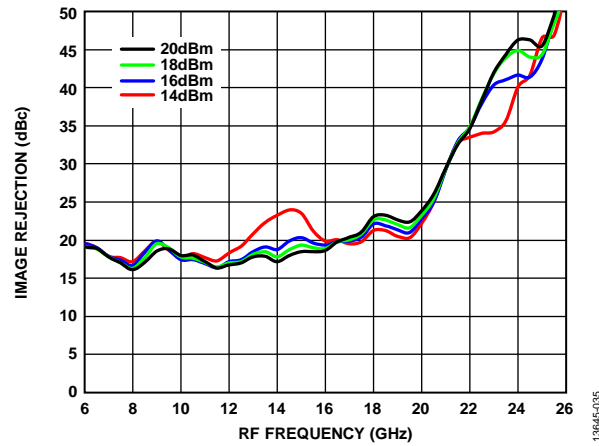

Figure 31. Image Rejection vs. RF Frequency at Various LO Drives, $T_A = 25^\circ\text{C}$

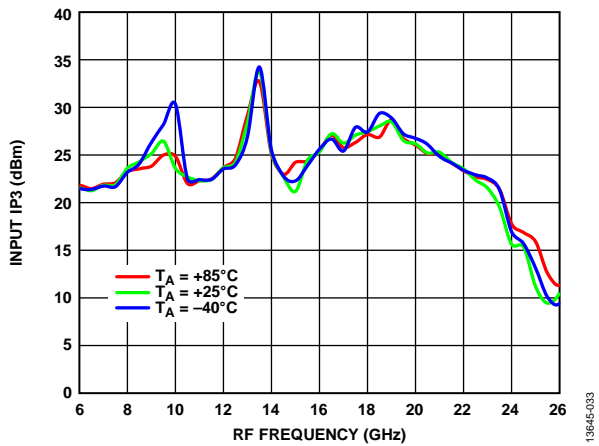

Figure 29. Input IP3 vs. RF Frequency at Various Temperatures, LO Drive = 18 dBm

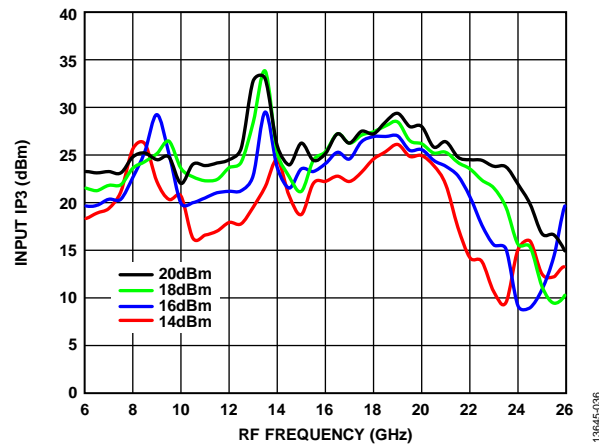

Figure 32. Input IP3 vs. RF Frequency at Various LO Drives, $T_A = 25^\circ\text{C}$

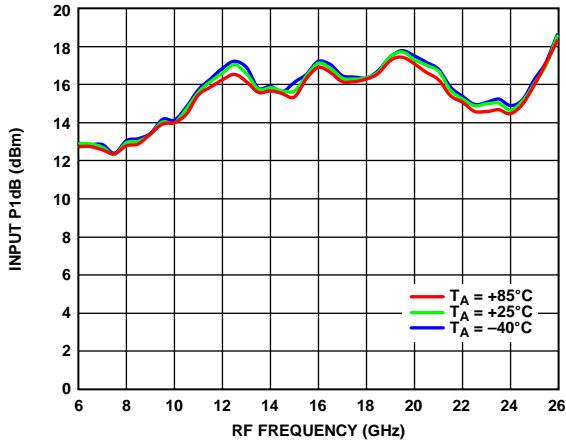

Figure 33. Input P1dB vs. RF Frequency at Various Temperatures, LO Drive = 18 dBm

13845-037

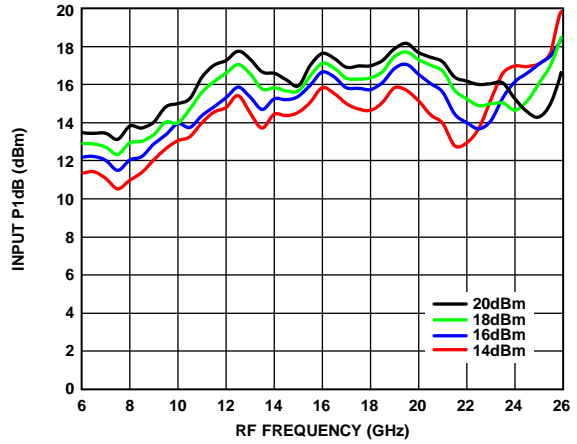

Figure 35. Input P1dB vs. RF Frequency at Various LO Drives, $T_A = 25^\circ\text{C}$

13845-039

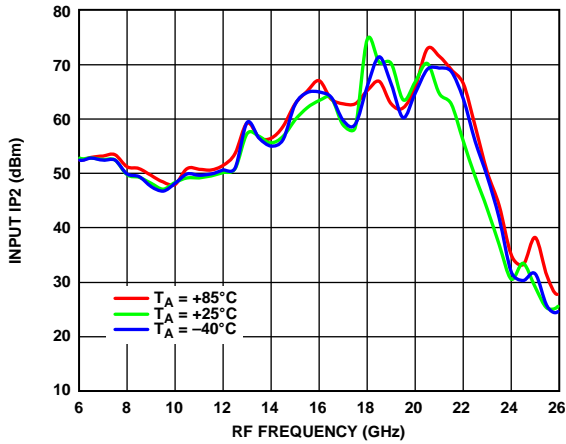

Figure 34. Input IP2 vs. RF Frequency at Various Temperatures, LO Drive = 18 dBm

13845-038

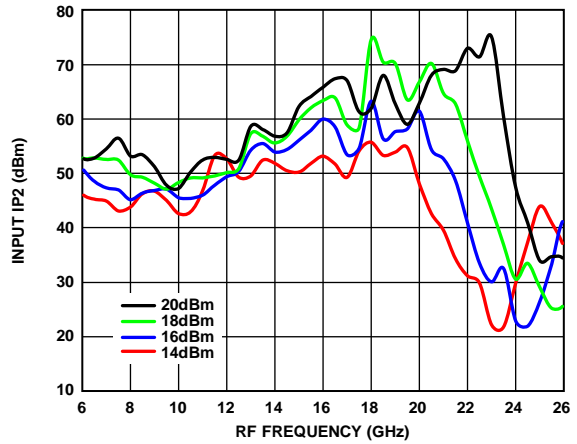

Figure 36. Input IP2 vs. RF Frequency at Various LO Drives, $T_A = 25^\circ\text{C}$

13845-040

DOWNCONVERTER PERFORMANCE: IF = 100 MHz, UPPER SIDEBAND (LOW-SIDE LO)

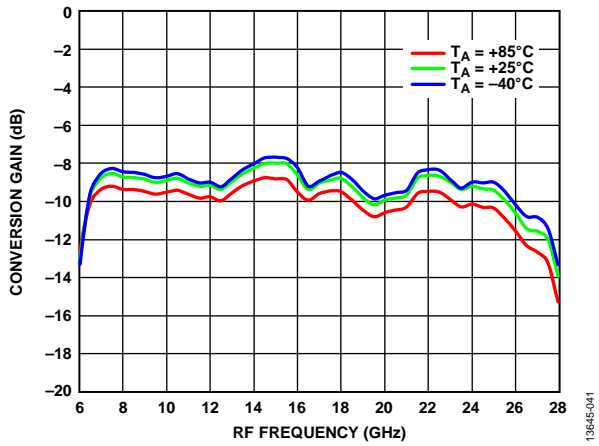

Figure 37. Conversion Gain vs. RF Frequency at Various Temperatures, LO Drive = 18 dBm

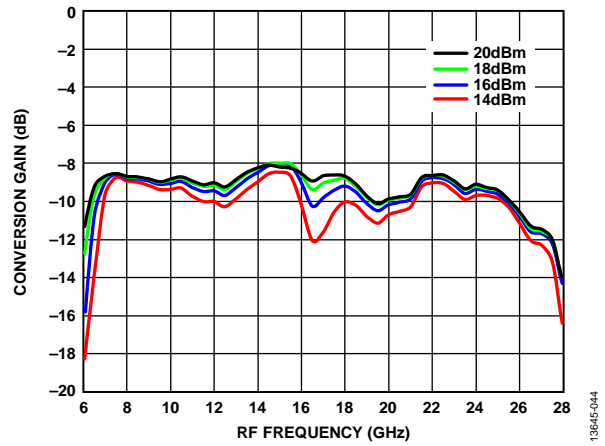

Figure 40. Conversion Gain vs. RF Frequency at Various LO Drives, $T_A = 25^\circ\text{C}$

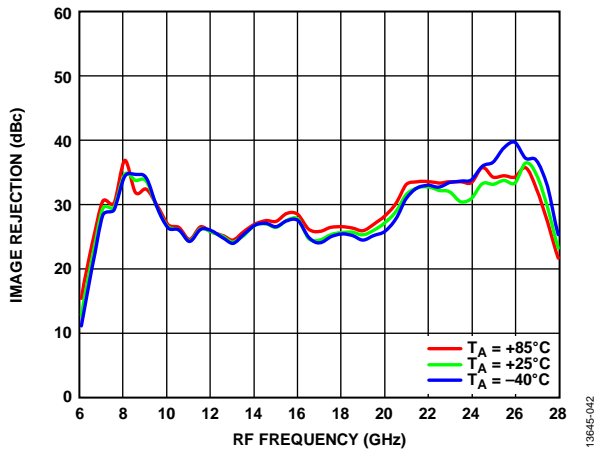

Figure 38. Image Rejection vs. RF Frequency at Various Temperatures, LO Drive = 18 dBm

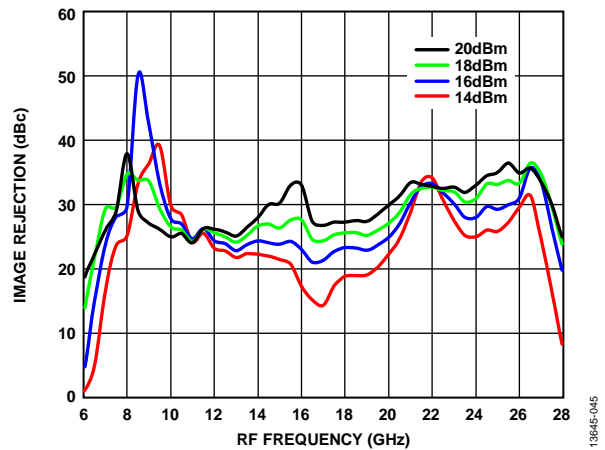

Figure 41. Image Rejection vs. RF Frequency at Various LO Drives, $T_A = 25^\circ\text{C}$

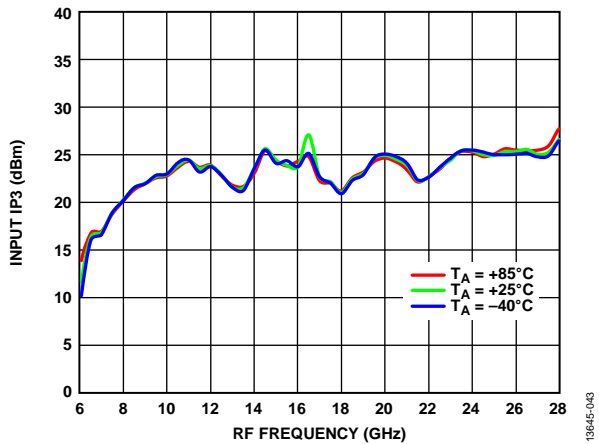

Figure 39. Input IP3 vs. RF Frequency at Various Temperatures, LO Drive = 18 dBm

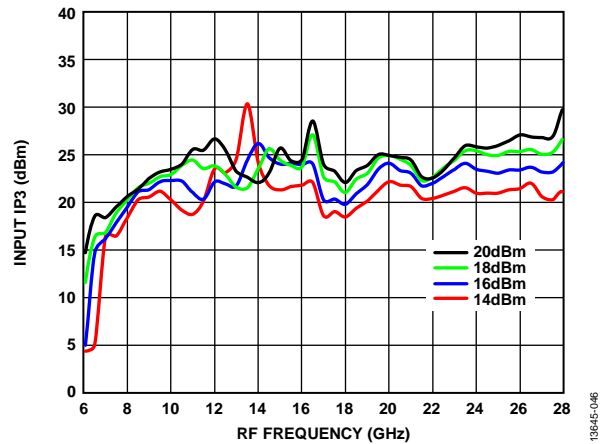

Figure 42. Input IP3 vs. RF Frequency at Various LO Drives, $T_A = 25^\circ\text{C}$

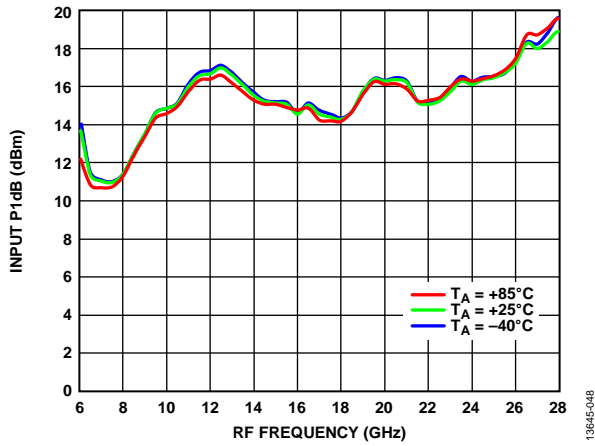

Figure 43. Input P1dB vs. RF Frequency at Various Temperatures, LO Drive = 18 dBm

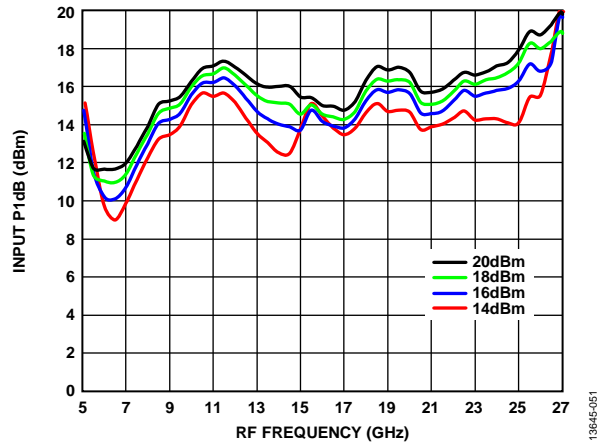

Figure 45. Input P1dB vs. RF Frequency at Various LO Drives, $T_A = 25^\circ\text{C}$

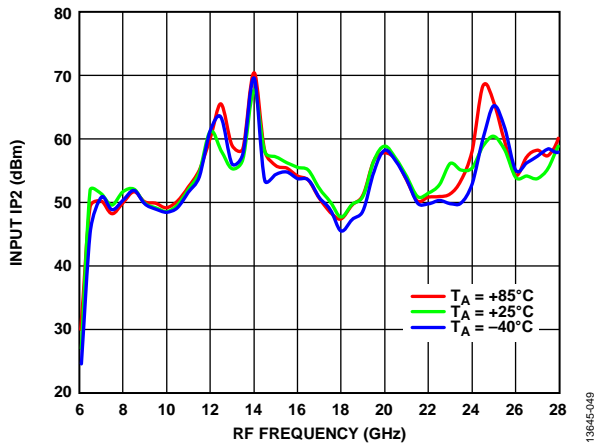

Figure 44. Input IP2 vs. RF Frequency at Various Temperatures, LO Drive = 18 dBm

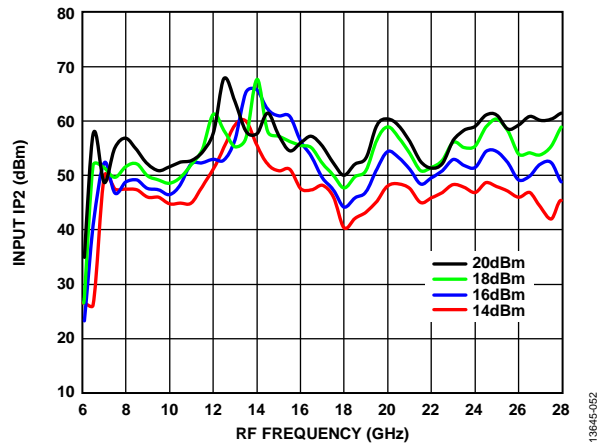

Figure 46. Input IP2 vs. RF Frequency at Various LO Drives, $T_A = 25^\circ\text{C}$

DOWNCONVERTER PERFORMANCE: IF = 2500 MHz, UPPER SIDEBAND (LOW-SIDE LO)

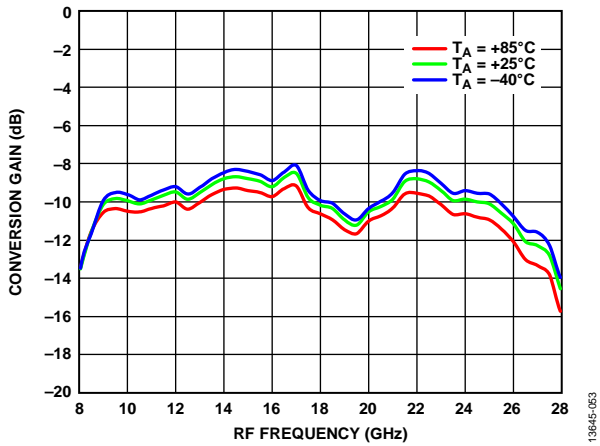

Figure 47. Conversion Gain vs. RF Frequency at Various Temperatures, LO Drive = 18 dBm

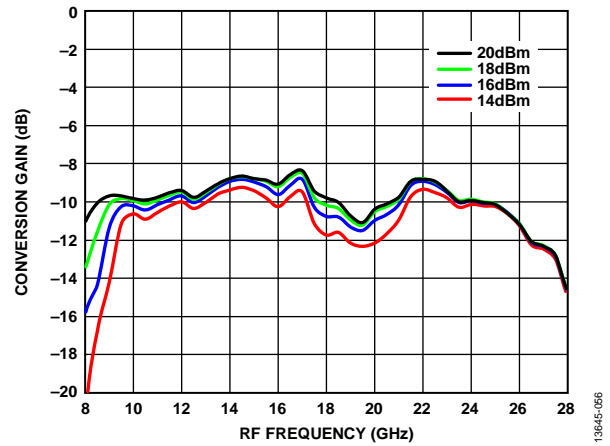

Figure 50. Conversion Gain vs. RF Frequency at Various LO Drives, $T_A = 25^\circ\text{C}$

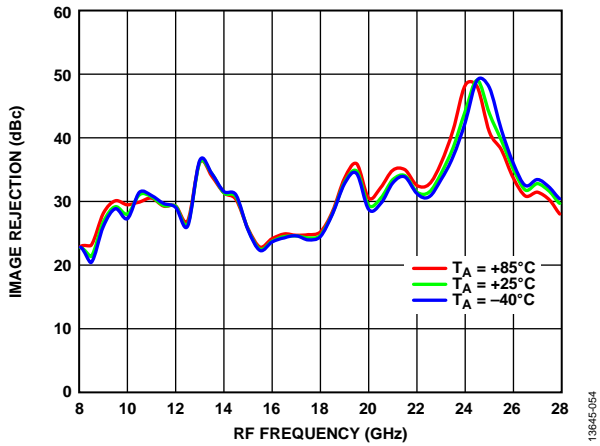

Figure 48. Image Rejection vs. RF Frequency at Various Temperatures, LO Drive = 18 dBm

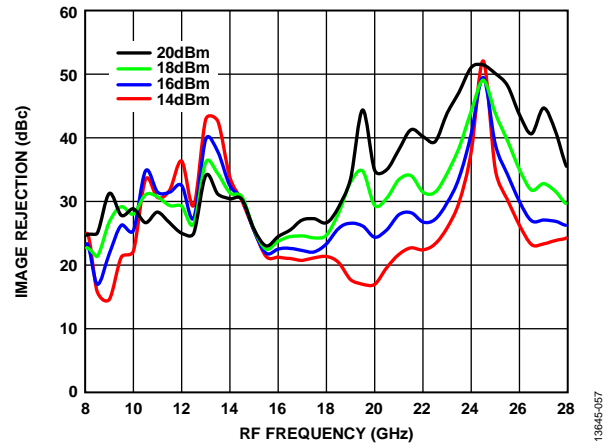

Figure 51. Image Rejection vs. RF Frequency at Various LO Drives, $T_A = 25^\circ\text{C}$

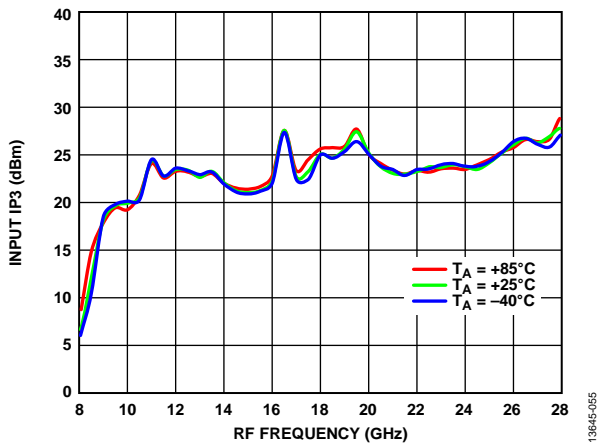

Figure 49. Input IP3 vs. RF Frequency at Various Temperatures, LO Drive = 18 dBm

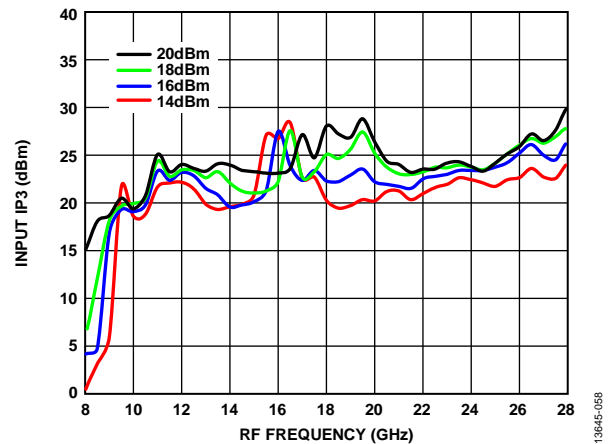

Figure 52. Input IP3 vs. RF Frequency at Various LO Drives, $T_A = 25^\circ\text{C}$

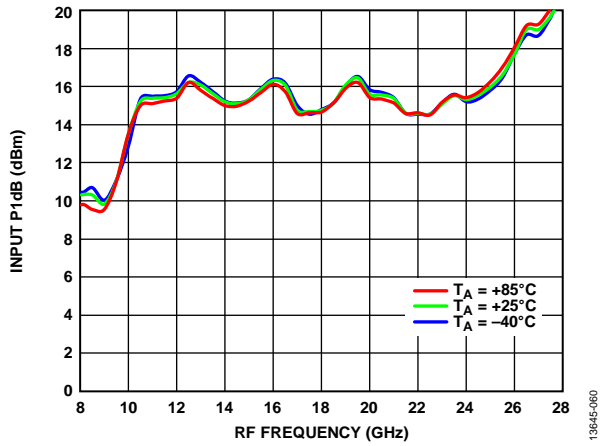

Figure 53. Input P1dB vs. RF Frequency at Various Temperatures, LO Drive = 18 dBm

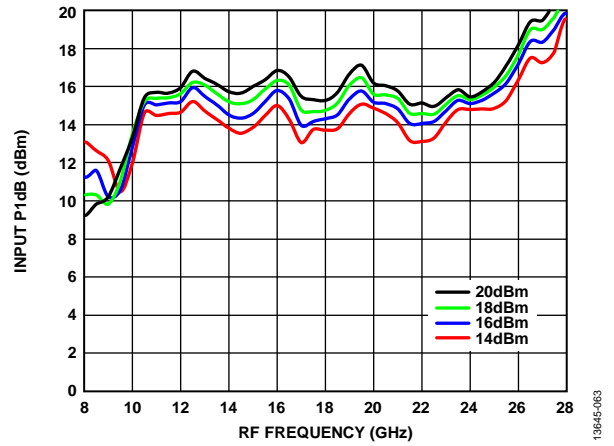

Figure 55. Input P1dB vs. RF Frequency at Various LO Drives, $T_A = 25^\circ\text{C}$

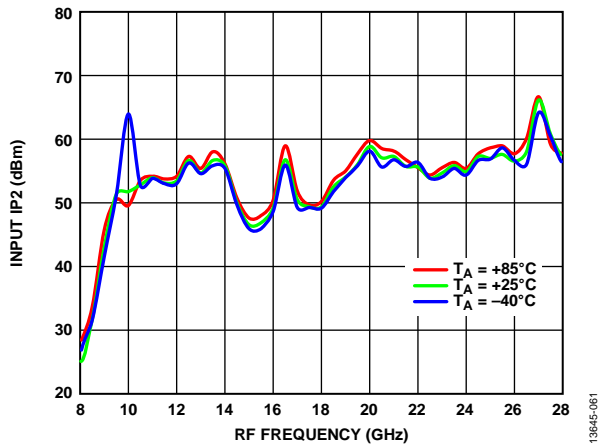

Figure 54. Input IP2 vs. RF Frequency at Various Temperatures, LO Drive = 18 dBm

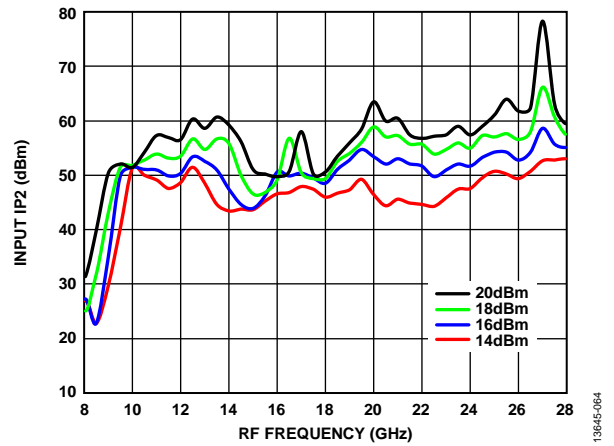

Figure 56. Input IP2 vs. RF Frequency at Various LO Drives, $T_A = 25^\circ\text{C}$

DOWNCONVERTER PERFORMANCE: IF = 5000 MHz, UPPER SIDEBAND (LOW-SIDE LO)

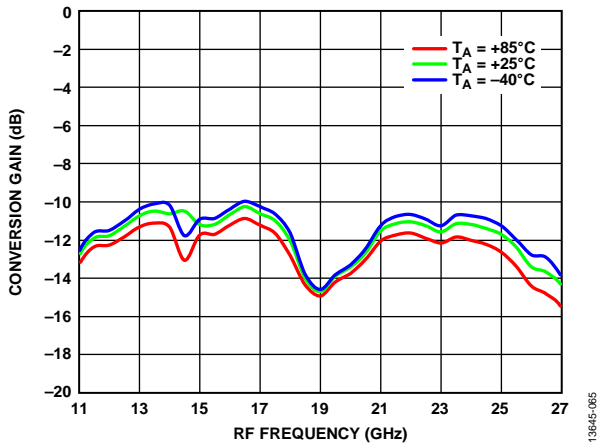

Figure 57. Conversion Gain vs. RF Frequency at Various Temperatures, LO Drive = 18 dBm

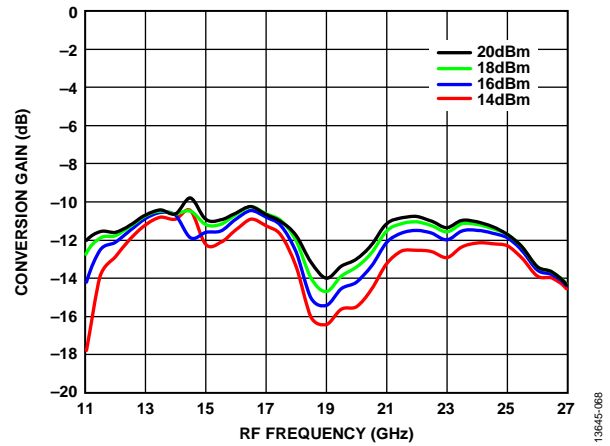

Figure 60. Conversion Gain vs. RF Frequency at Various LO Drives, $T_A = 25^\circ\text{C}$

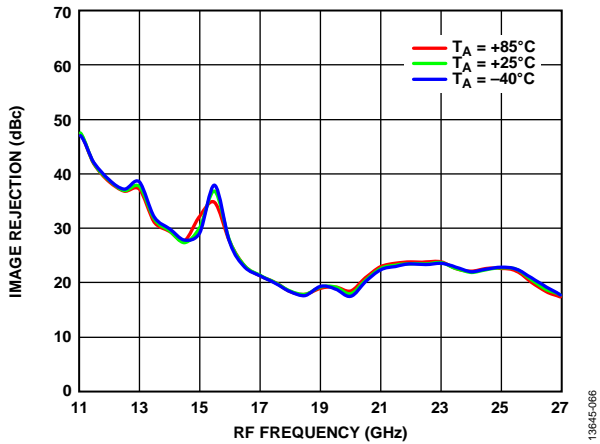

Figure 58. Image Rejection vs. RF Frequency at Various Temperatures, LO Drive = 18 dBm

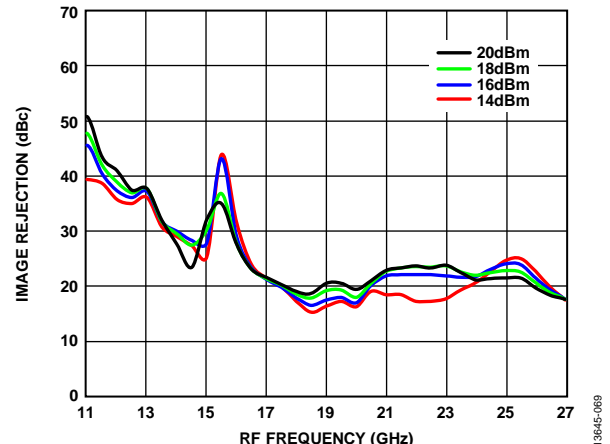

Figure 61. Image Rejection vs. RF Frequency at Various LO Drives, $T_A = 25^\circ\text{C}$

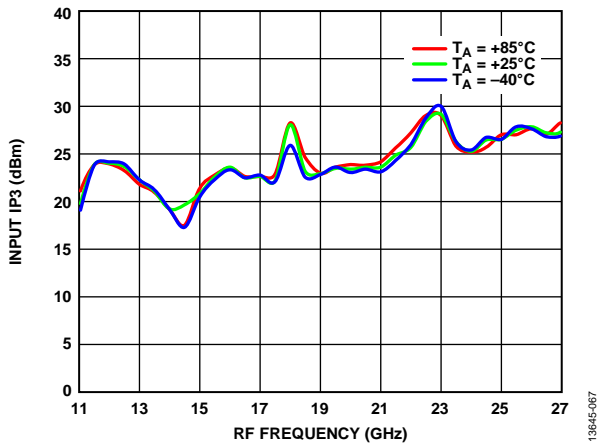

Figure 59. Input IP3 vs. RF Frequency at Various Temperatures, LO Drive = 18 dBm

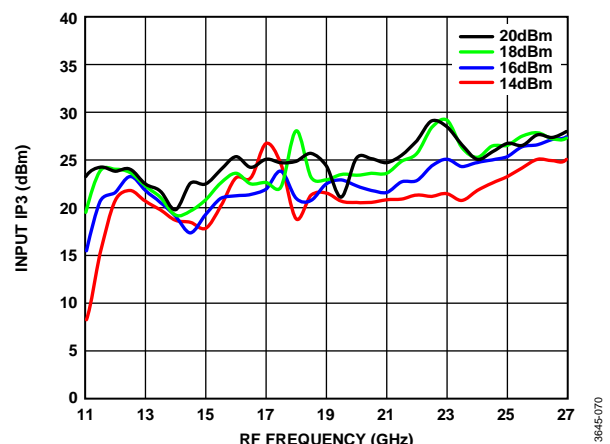

Figure 62. Input IP3 vs. RF Frequency at Various LO Drives, $T_A = 25^\circ\text{C}$

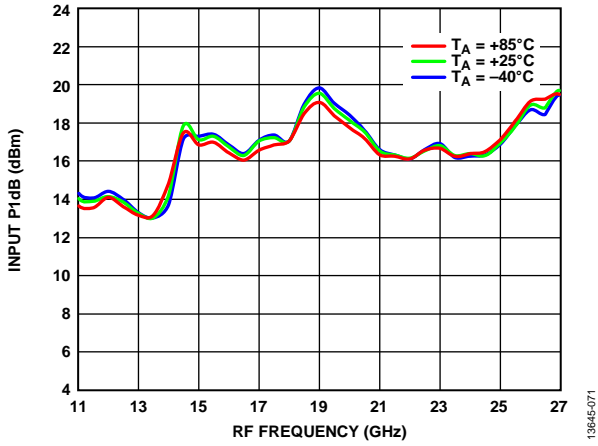

Figure 63. Input P1dB vs. RF Frequency at Various Temperatures, LO Drive = 18 dBm

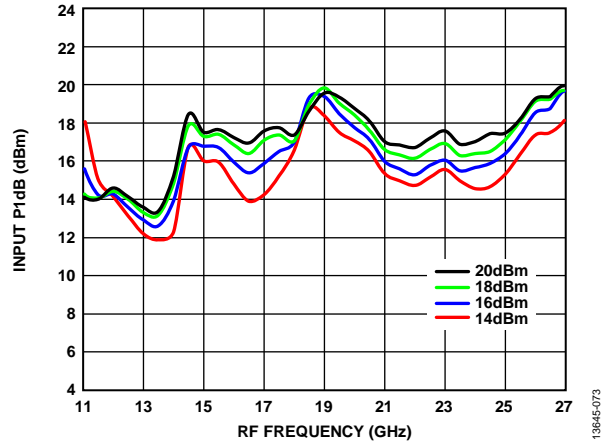

Figure 65. Input P1dB vs. RF Frequency at Various LO Drives, $T_A = 25^\circ\text{C}$

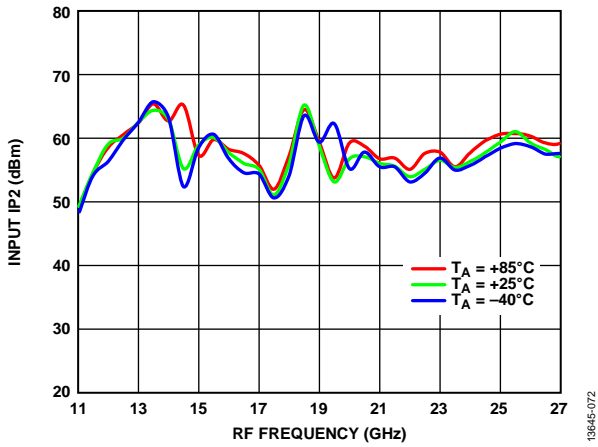

Figure 64. Input IP2 vs. RF Frequency at Various Temperatures, LO Drive = 18 dBm

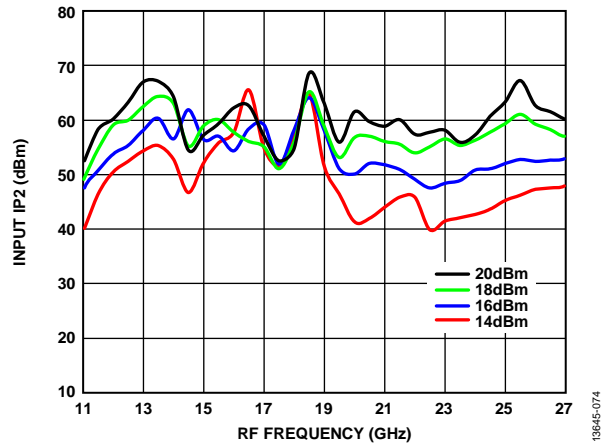

Figure 66. Input IP2 vs. RF Frequency at Various LO Drives, $T_A = 25^\circ\text{C}$

13645-071

13645-073

13645-072

13645-074

UPCONVERTER PERFORMANCE: IF = 100 MHz, LOWER SIDEBAND (HIGH-SIDE LO)

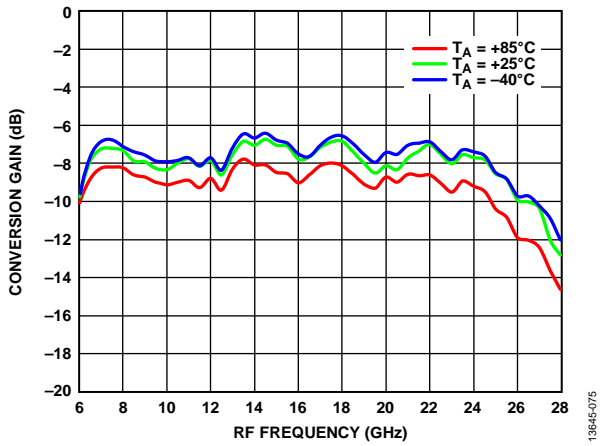

Figure 67. Conversion Gain vs. RF Frequency at Various Temperatures, LO Drive = 18 dBm

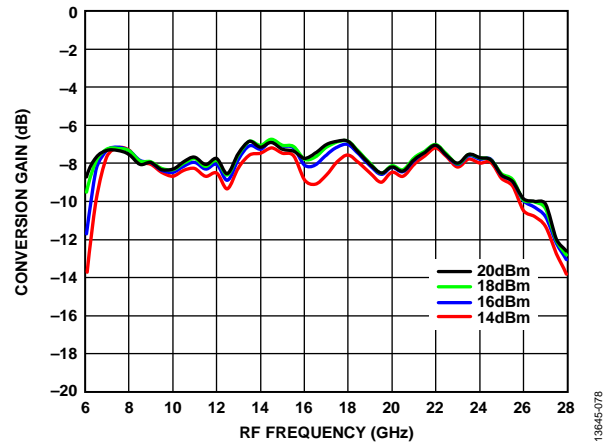

Figure 70. Conversion Gain vs. RF Frequency at Various LO Drives, $T_A = 25^\circ\text{C}$

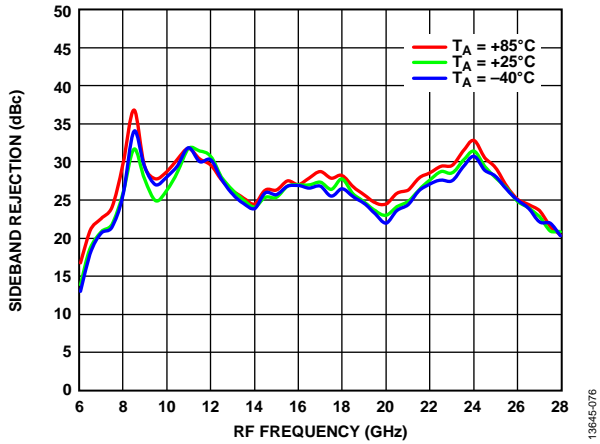

Figure 68. Sideband Rejection vs. RF Frequency at Various Temperatures, LO Drive = 18 dBm

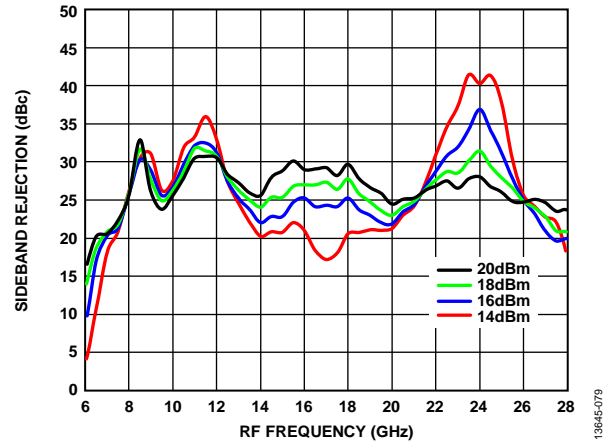

Figure 71. Sideband Rejection vs. RF Frequency at Various LO Drives, $T_A = 25^\circ\text{C}$

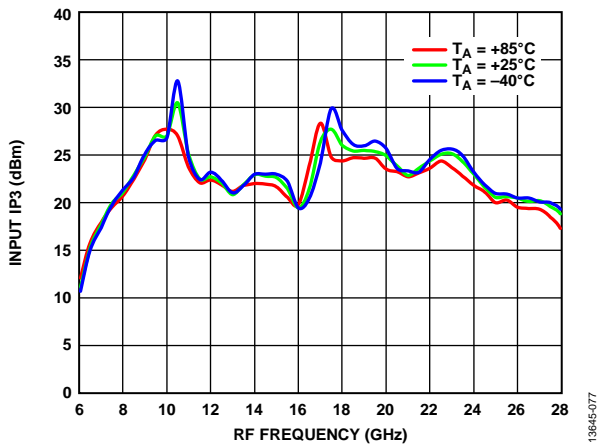

Figure 69. Input IP3 vs. RF Frequency at Various Temperatures, LO Drive = 18 dBm

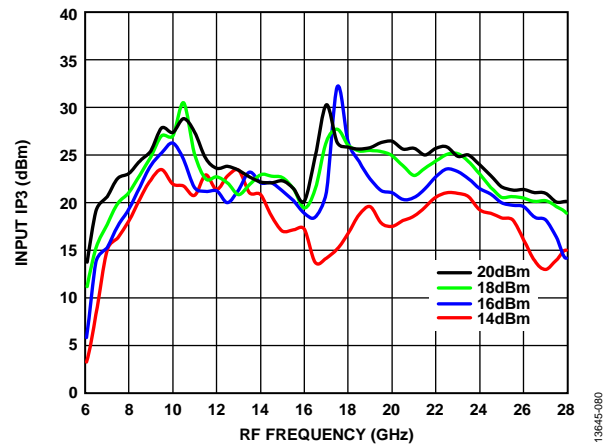

Figure 72. Input IP3 vs. RF Frequency at Various LO Drives, $T_A = 25^\circ\text{C}$

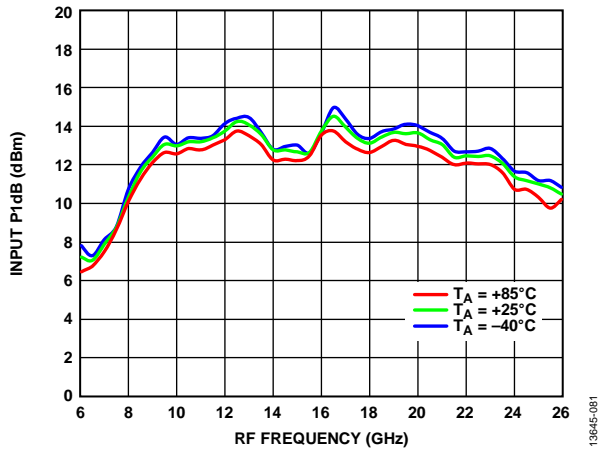

Figure 73. Input P1dB vs. RF Frequency at Various Temperatures, LO Drive = 18 dBm

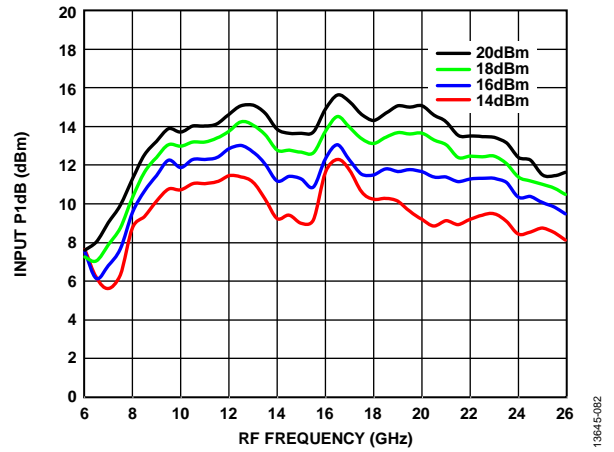

Figure 74. Input P1dB vs. RF Frequency at Various LO Drives, $T_A = 25^\circ\text{C}$

UPCONVERTER PERFORMANCE: IF = 2500 MHz, LOWER SIDEBAND (HIGH-SIDE LO)

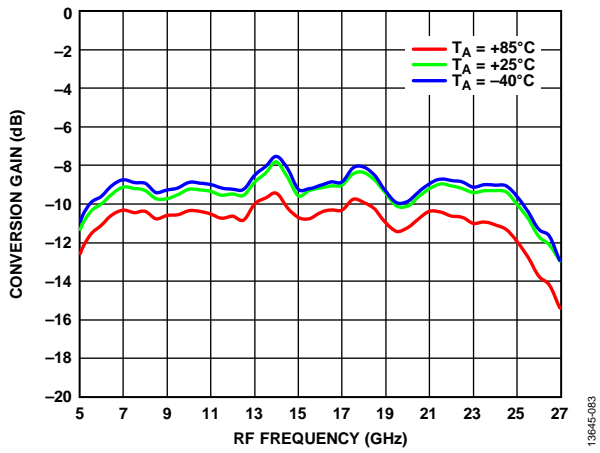

Figure 75. Conversion Gain vs. RF Frequency at Various Temperatures, LO Drive = 18 dBm

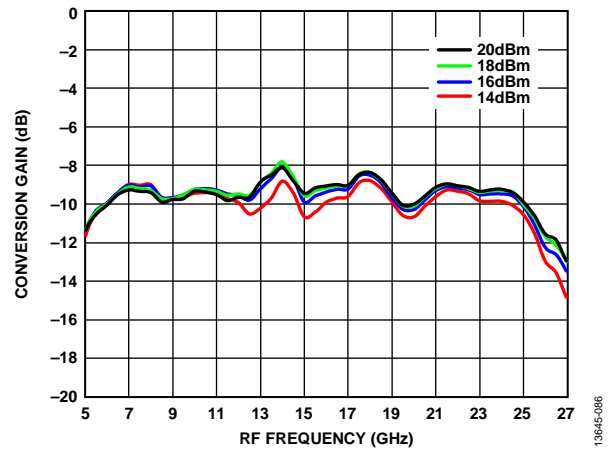

Figure 78. Conversion Gain vs. RF Frequency at Various LO Drives, $T_A = 25^\circ\text{C}$

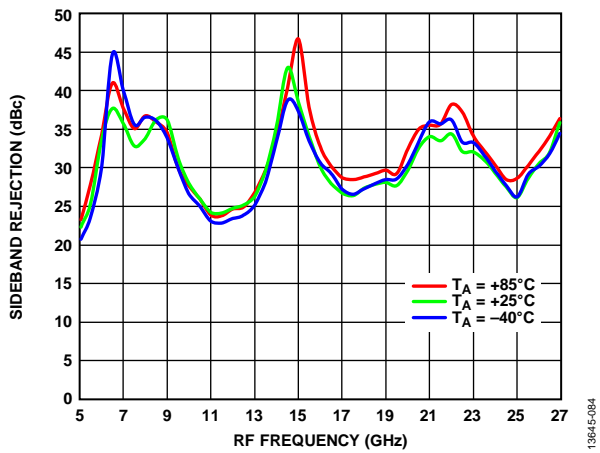

Figure 76. Sideband Rejection vs. RF Frequency at Various Temperatures, LO Drive = 18 dBm

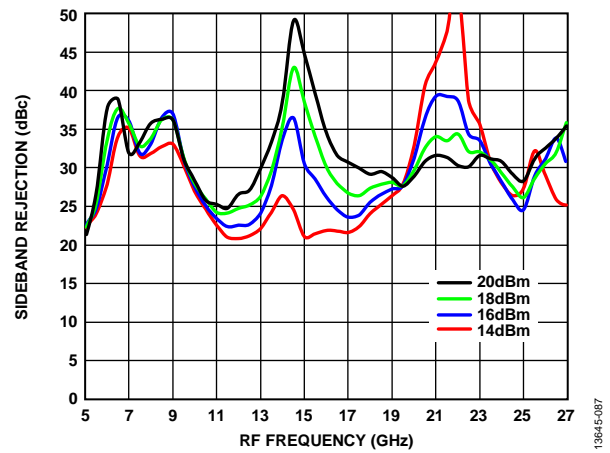

Figure 79. Sideband Rejection vs. RF Frequency at Various LO Drives, $T_A = 25^\circ\text{C}$

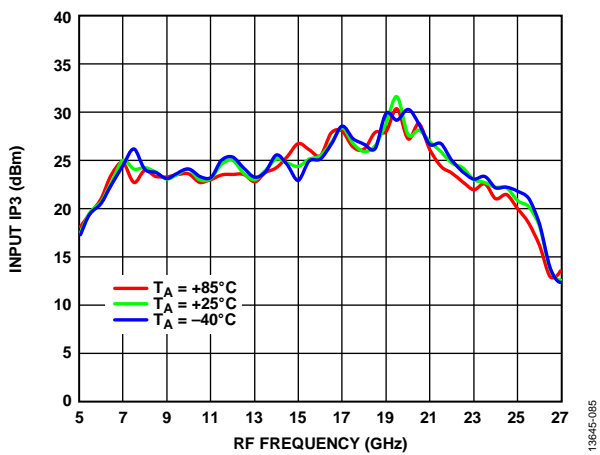

Figure 77. Input IP3 vs. RF Frequency at Various Temperatures, LO Drive = 18 dBm

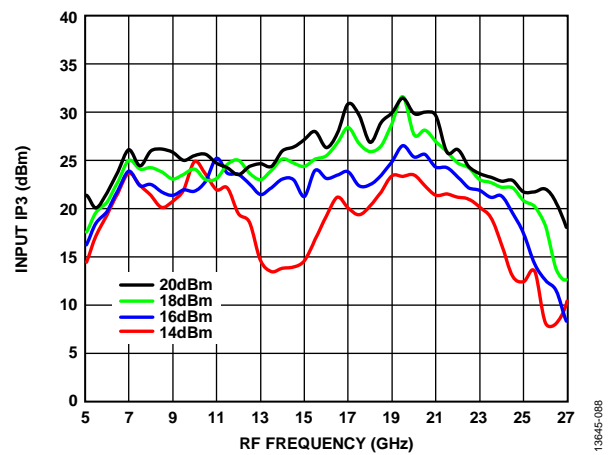

Figure 80. Input IP3 vs. RF Frequency at Various LO Drives, $T_A = 25^\circ\text{C}$

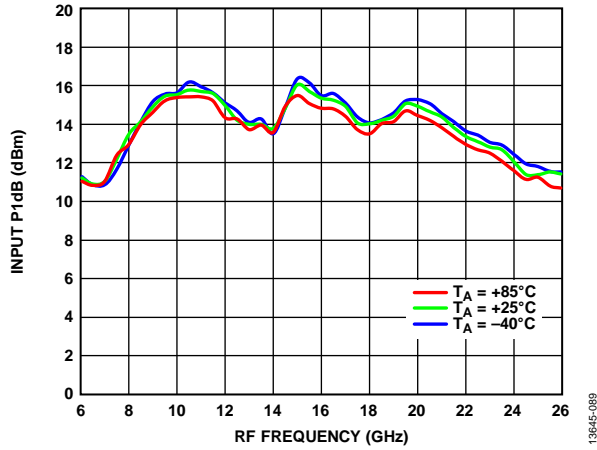

Figure 81. Input P1dB vs. RF Frequency at Various Temperatures, LO Drive = 18 dBm

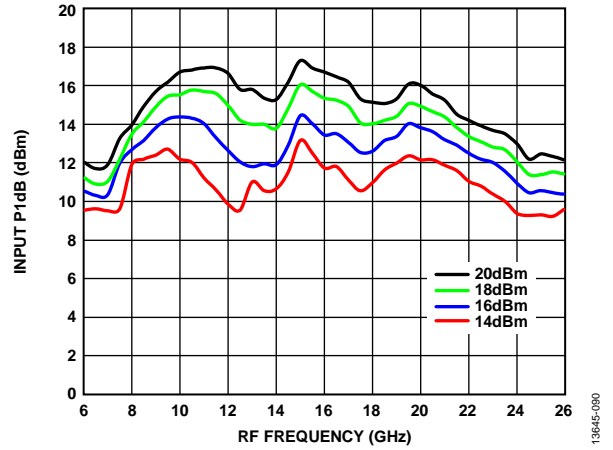

Figure 82. Input P1dB vs. RF Frequency at Various LO Drives, $T_A = 25^\circ\text{C}$

UPCONVERTER PERFORMANCE: IF = 5000 MHz, LOWER SIDEBAND (HIGH-SIDE LO)

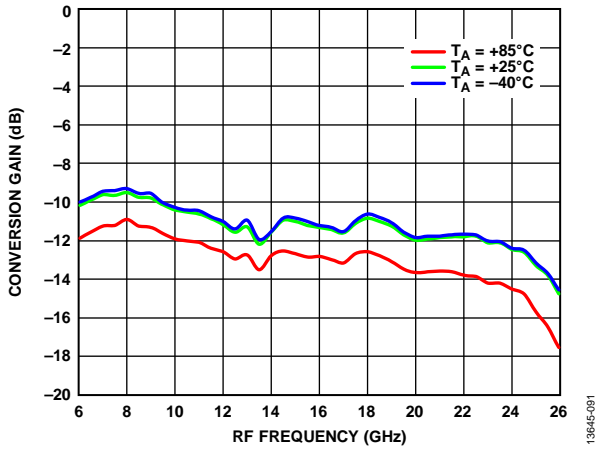

Figure 83. Conversion Gain vs. RF Frequency at Various Temperatures, LO Drive = 18 dBm

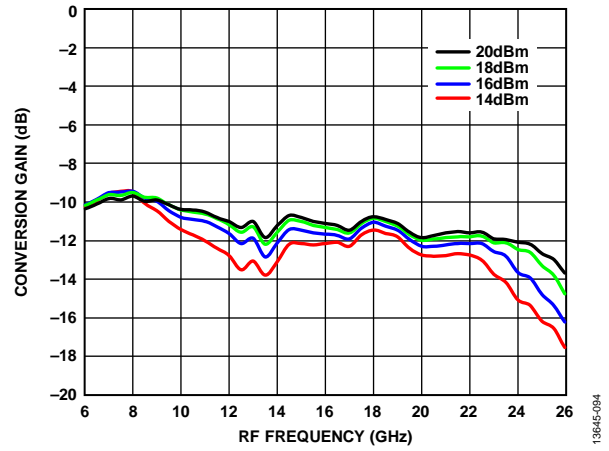

Figure 86. Conversion Gain vs. RF Frequency at Various LO Drives, $T_A = 25^\circ\text{C}$

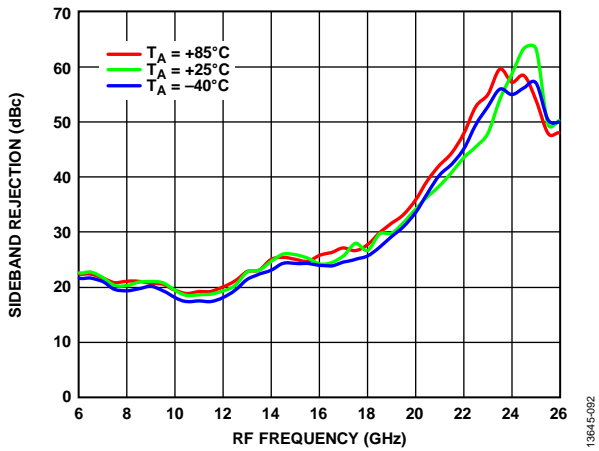

Figure 84. Sideband Rejection vs. RF Frequency at Various Temperatures, LO Drive = 18 dBm

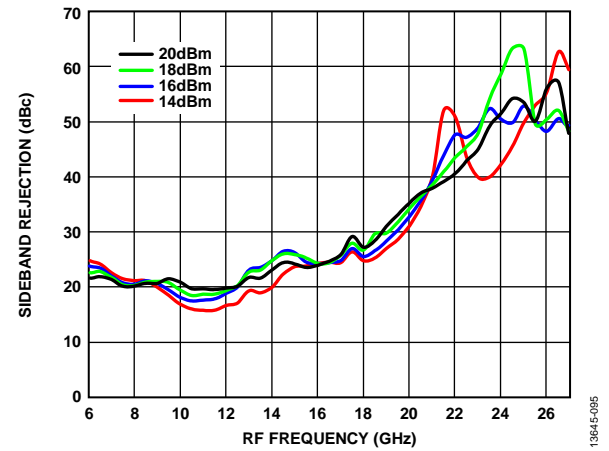

Figure 87. Sideband Rejection vs. RF Frequency at Various LO Drives, $T_A = 25^\circ\text{C}$

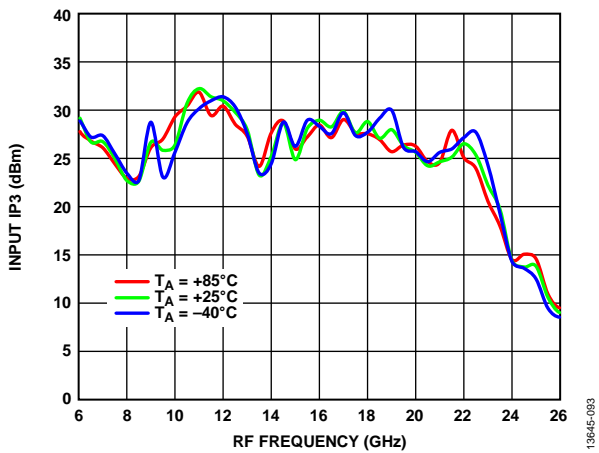

Figure 85. Input IP3 vs. RF Frequency at Various Temperatures, LO Drive = 18 dBm

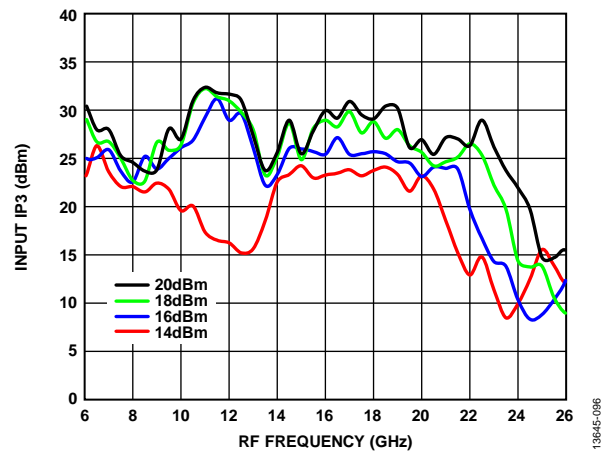

Figure 88. Input IP3 vs. RF Frequency at Various LO Drives, $T_A = 25^\circ\text{C}$

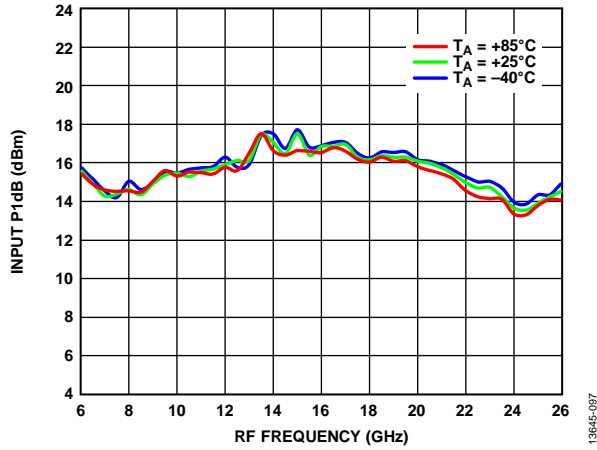

Figure 89. Input P1dB vs. RF Frequency at Various Temperatures, LO Drive = 18 dBm

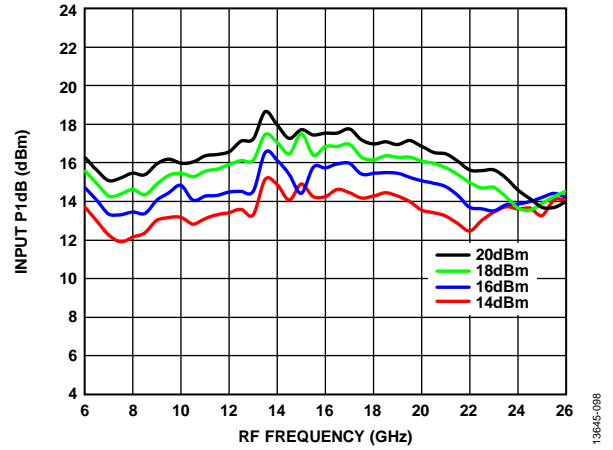

Figure 90. Input P1dB vs. RF Frequency at Various LO Drives, $T_A = 25^\circ\text{C}$

UPCONVERTER PERFORMANCE: IF = 100 MHz, UPPER SIDEBAND (LOW-SIDE LO)

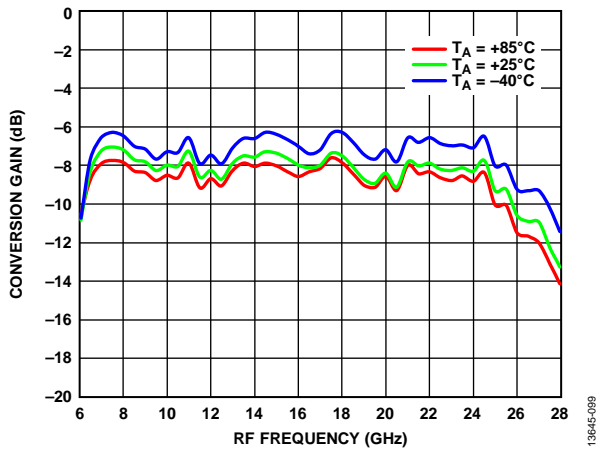

Figure 91. Conversion Gain vs. RF Frequency at Various Temperatures, LO Drive = 18 dBm

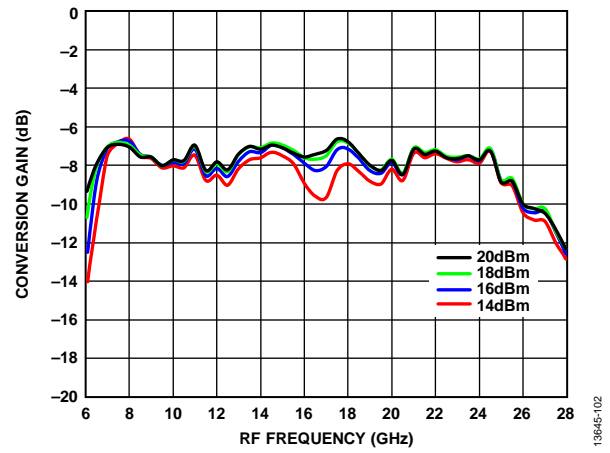

Figure 94. Conversion Gain vs. RF Frequency at Various LO Drives, $T_A = 25^\circ\text{C}$

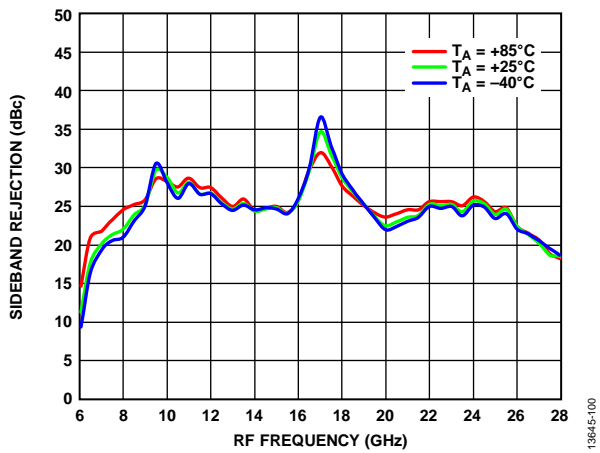

Figure 92. Sideband Rejection vs. RF Frequency at Various Temperatures, LO Drive = 18 dBm

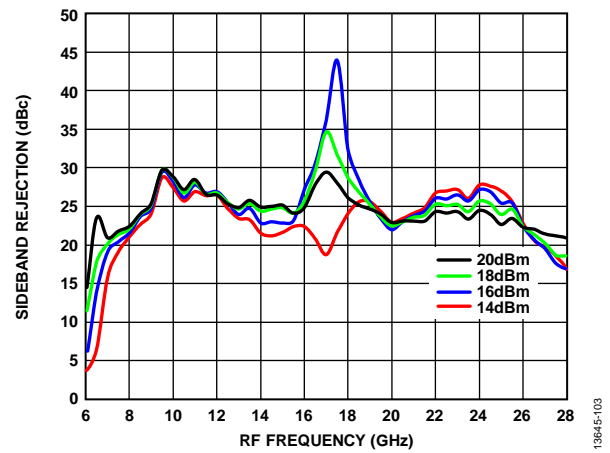

Figure 95. Sideband Rejection vs. RF Frequency at Various LO Drives, $T_A = 25^\circ\text{C}$

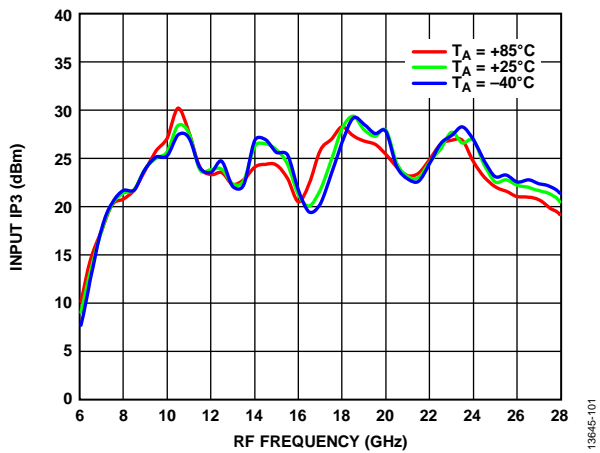

Figure 93. Input IP3 vs. RF Frequency at Various Temperatures, LO Drive = 18 dBm

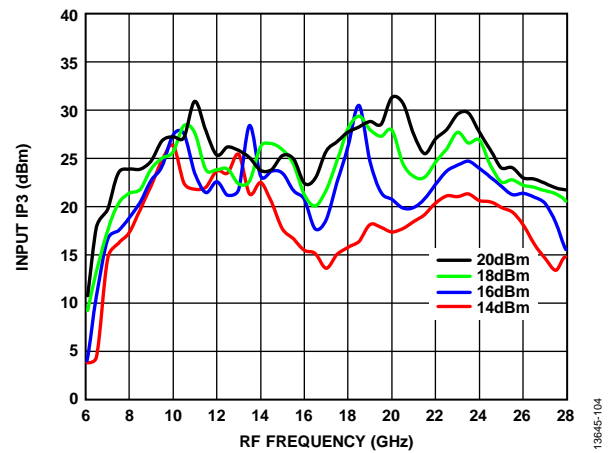

Figure 96. Input IP3 vs. RF Frequency at Various LO Drives, $T_A = 25^\circ\text{C}$

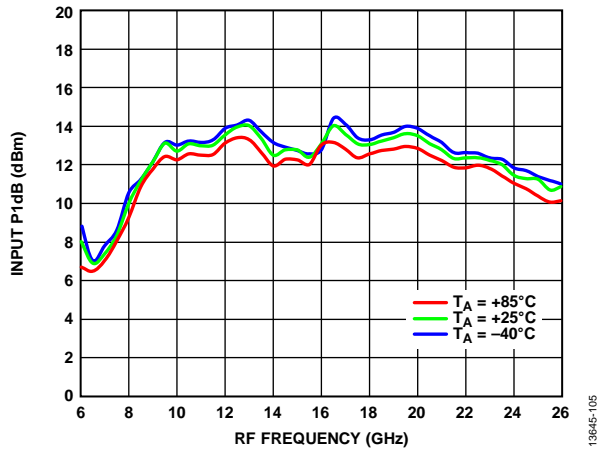

Figure 97. Input P1dB vs. RF Frequency at Various Temperatures, LO Drive = 18 dBm

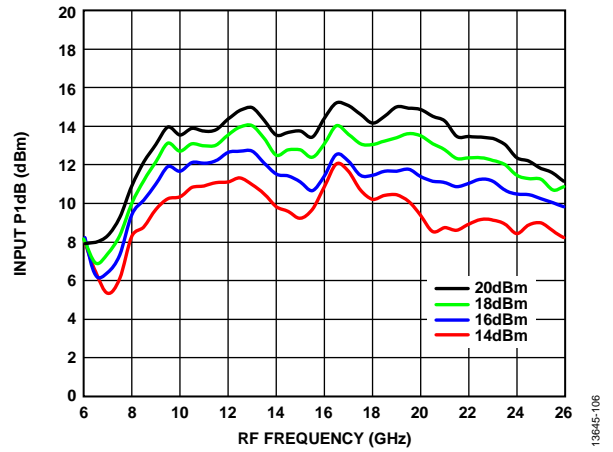

Figure 98. Input P1dB vs. RF Frequency at Various LO Drives, TA = 25°C

UPCONVERTER PERFORMANCE: IF = 2500 MHz, UPPER SIDEBAND (LOW-SIDE LO)

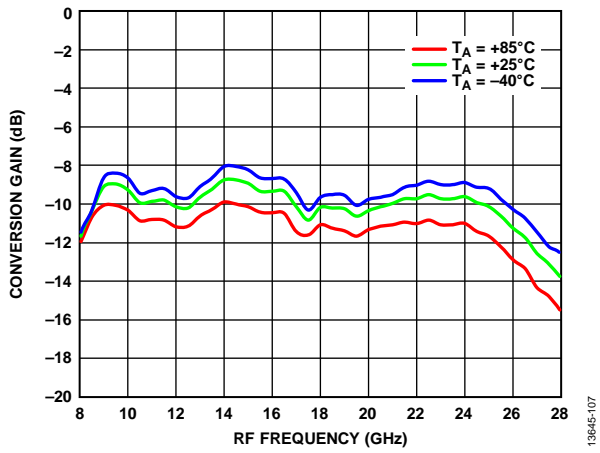

Figure 99. Conversion Gain vs. RF Frequency at Various Temperatures, LO Drive = 18 dBm

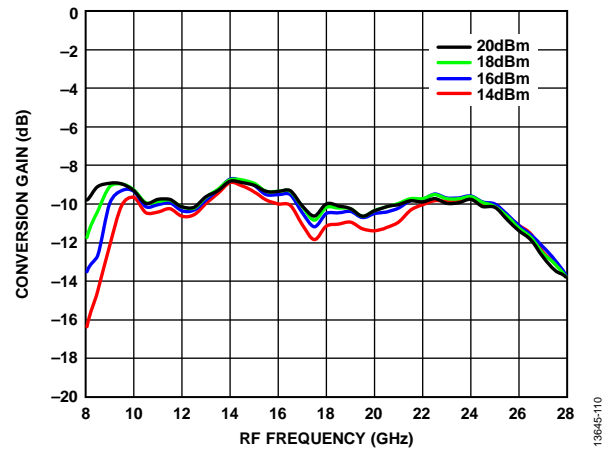

Figure 102. Conversion Gain vs. RF Frequency at Various LO Drives, $T_A = 25^\circ\text{C}$

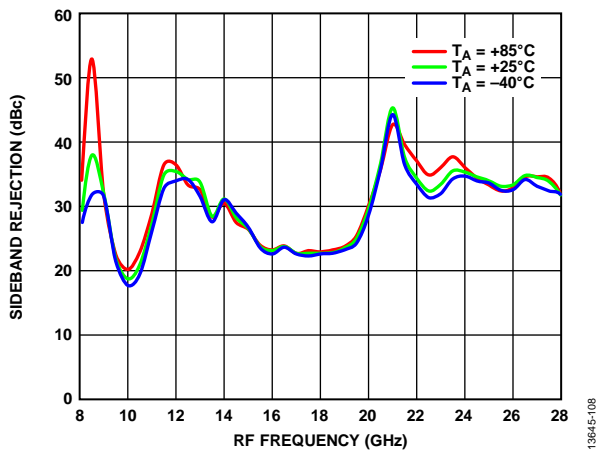

Figure 100. Sideband Rejection vs. RF Frequency at Various Temperatures, LO Drive = 18 dBm

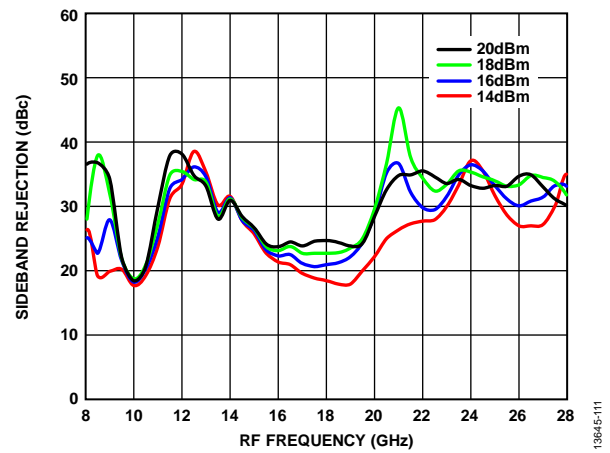

Figure 103. Sideband Rejection vs. RF Frequency at Various LO Drives, $T_A = 25^\circ\text{C}$

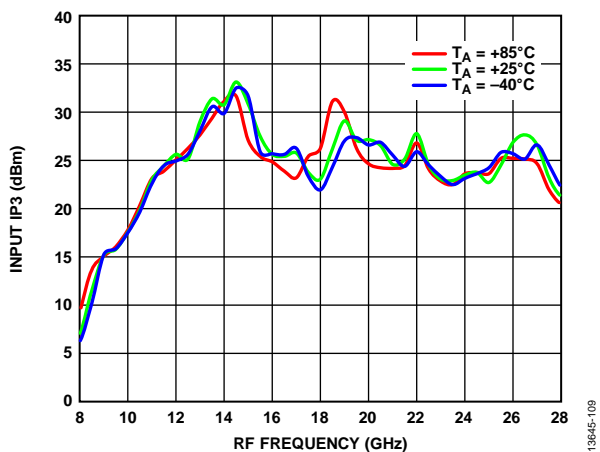

Figure 101. Input IP3 vs. RF Frequency at Various Temperatures, LO Drive = 18 dBm

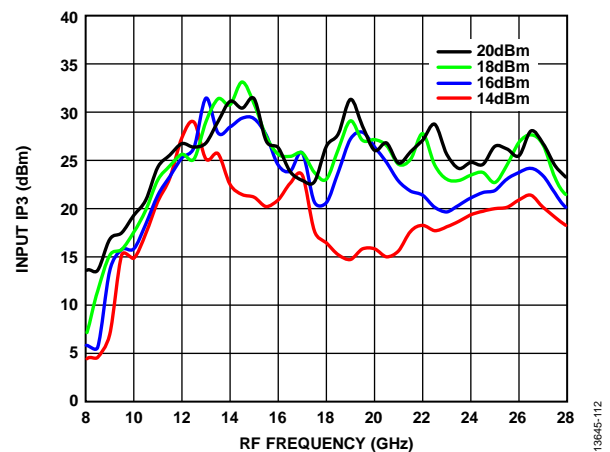

Figure 104. Input IP3 vs. RF Frequency at Various LO Drives, $T_A = 25^\circ\text{C}$

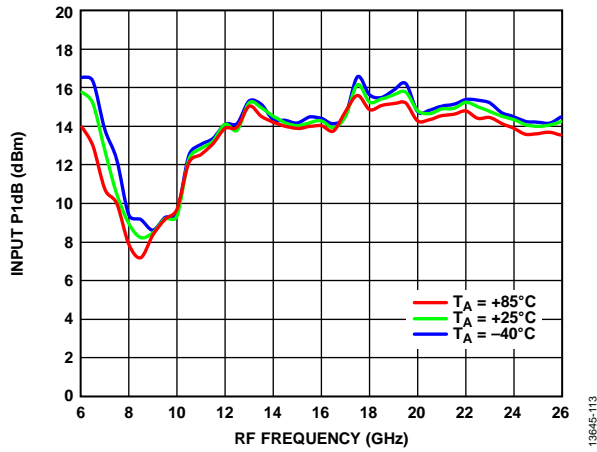

Figure 105. Input P1dB vs. RF Frequency at Various Temperatures, LO Drive = 18 dBm

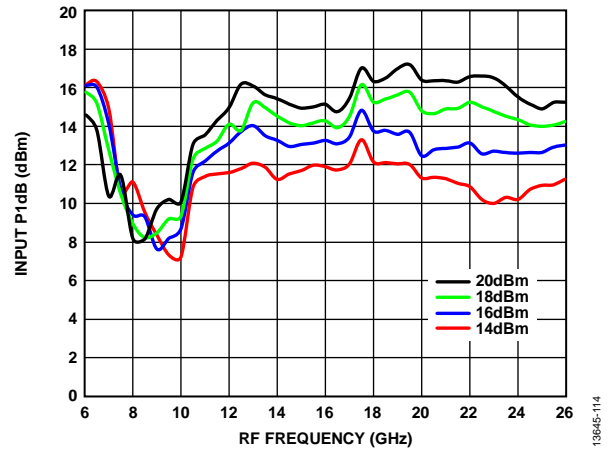

Figure 106. Input P1dB vs. RF Frequency at Various LO Drives, $T_A = 25^\circ\text{C}$

UPCONVERTER PERFORMANCE: IF = 5000 MHz, UPPER SIDEBAND (LOW-SIDE LO)

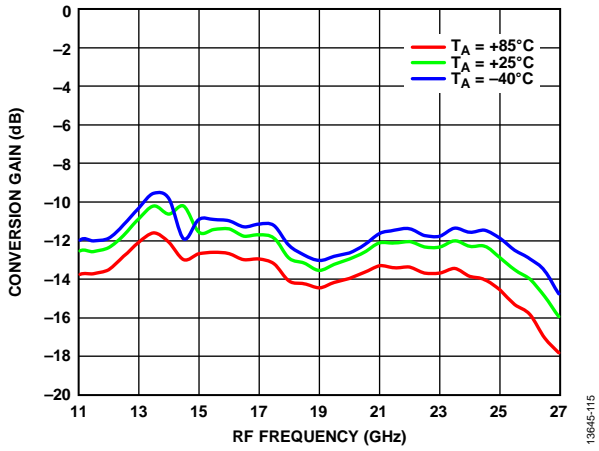

Figure 107. Conversion Gain vs. RF Frequency at Various Temperatures, LO Drive = 18 dBm

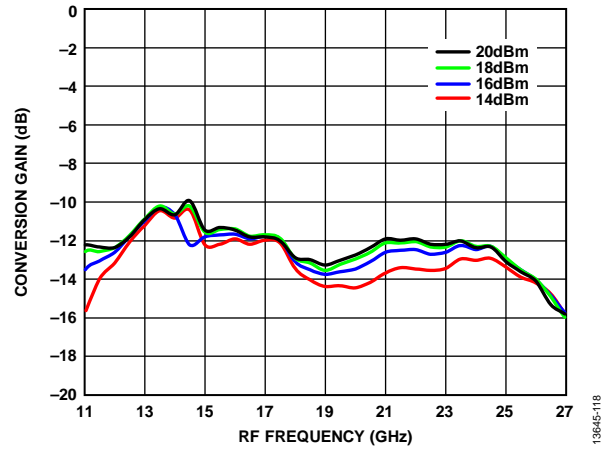

Figure 110. Conversion Gain vs. RF Frequency at Various LO Drives, $T_A = 25^\circ\text{C}$

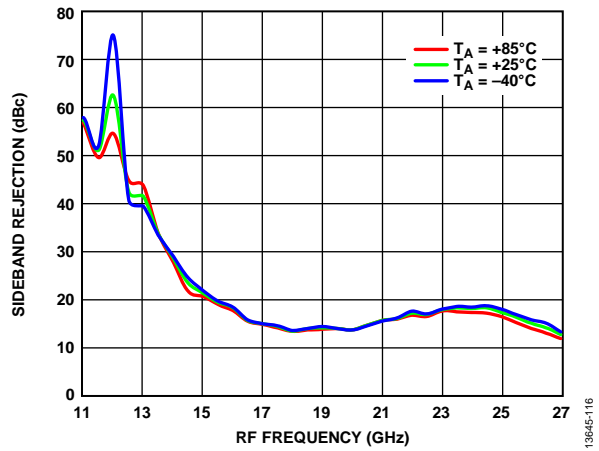

Figure 108. Sideband Rejection vs. RF Frequency at Various Temperatures, LO Drive = 18 dBm

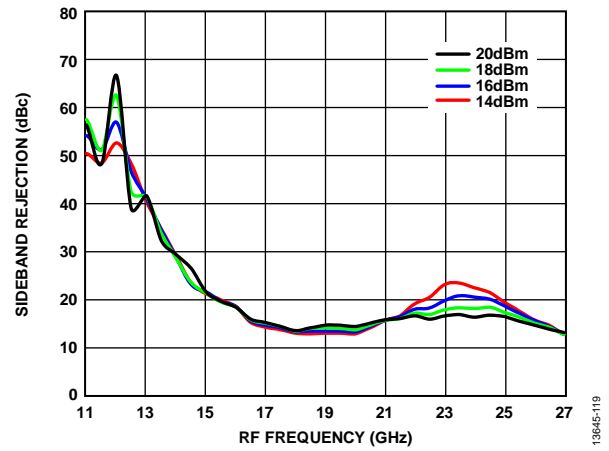

Figure 111. Sideband Rejection vs. RF Frequency at Various LO Drives, $T_A = 25^\circ\text{C}$

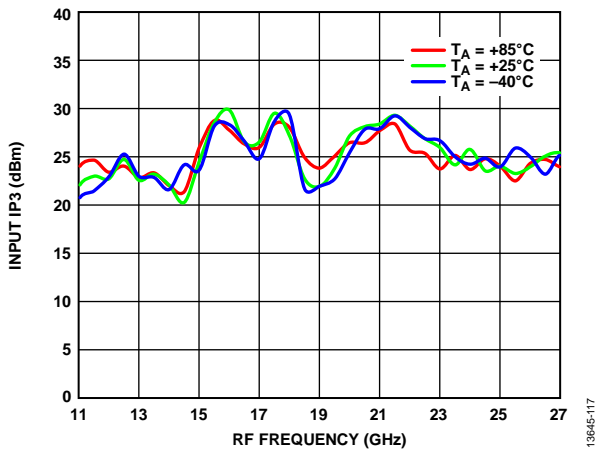

Figure 109. Input IP3 vs. RF Frequency at Various Temperatures, LO Drive = 18 dBm

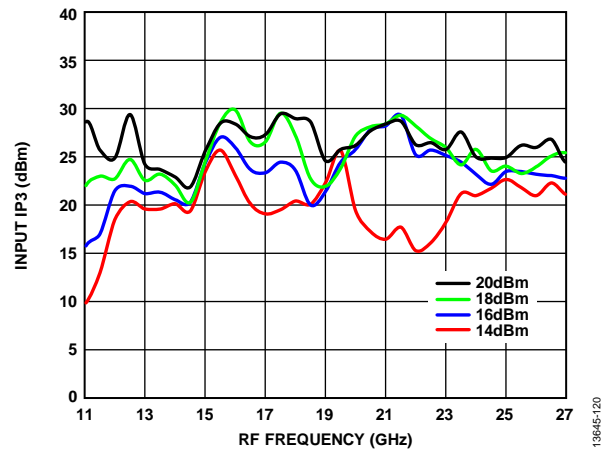

Figure 112. Input IP3 vs. RF Frequency at Various LO Drives, $T_A = 25^\circ\text{C}$

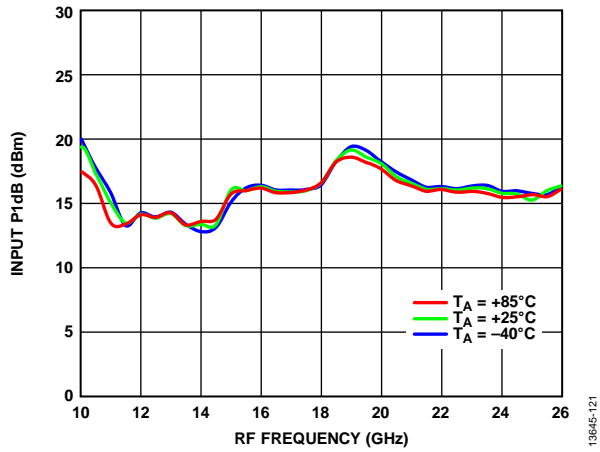

Figure 113. Input P1dB vs. RF Frequency at Various Temperatures, LO Drive = 18 dBm

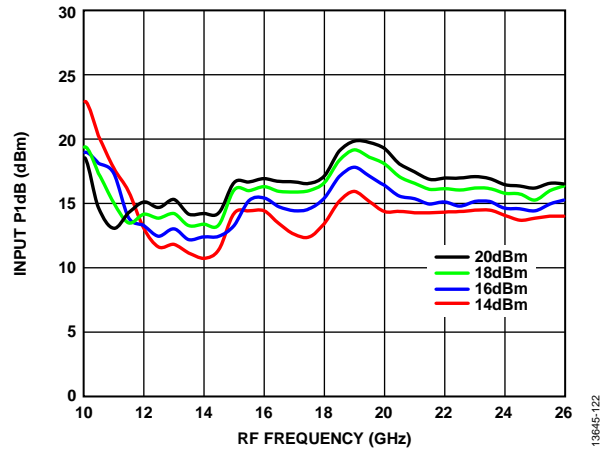

Figure 114. Input P1dB vs. RF Frequency at Various LO Drives, TA = 25°C

ISOLATION AND RETURN LOSS

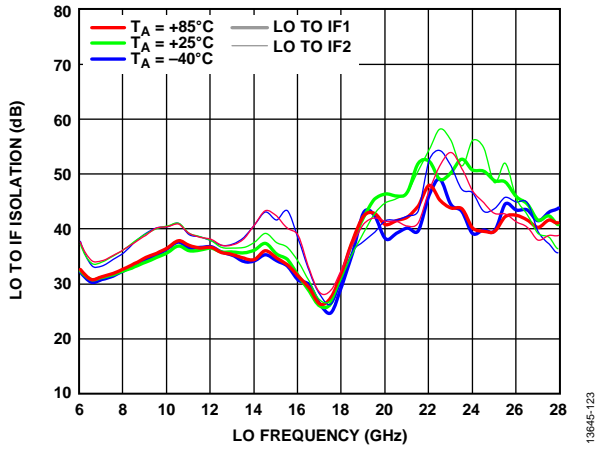

Figure 115. LO to IF Isolation vs. LO Frequency at Various Temperatures, IF = 100 MHz, LO Drive = 18 dBm

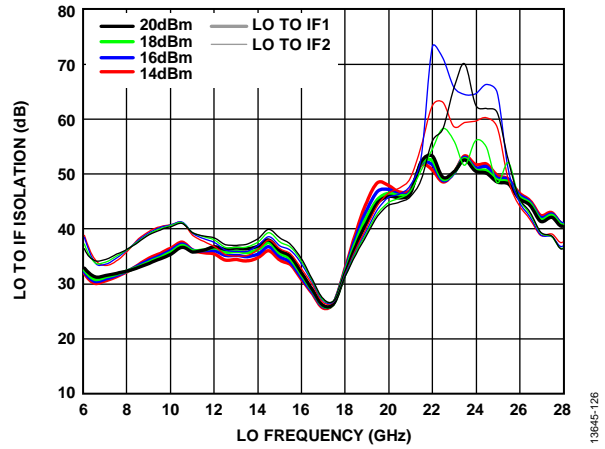

Figure 118. LO to IF Isolation vs. LO Frequency at Various LO Drives, IF = 100 MHz, TA = 25°C

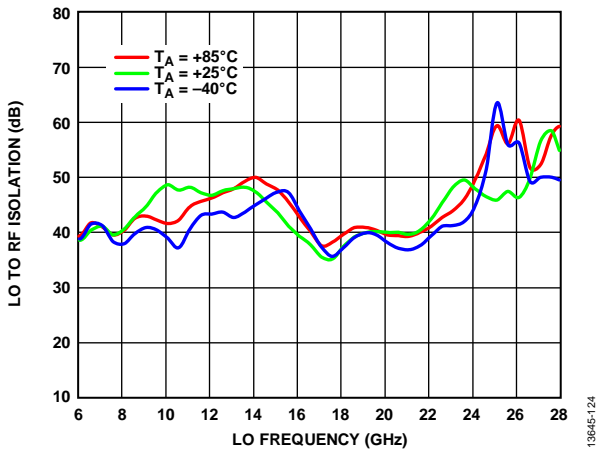

Figure 116. LO to RF Isolation vs. LO Frequency at Various Temperatures, IF = 100 MHz, LO Drive = 18 dBm

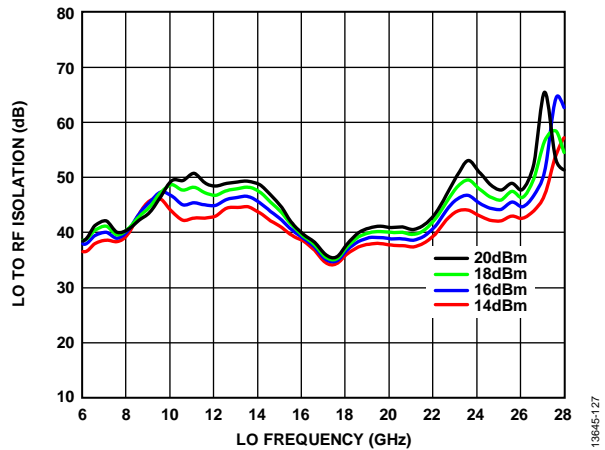

Figure 119. LO to RF Isolation vs. LO Frequency at Various LO Drives, IF = 100 MHz, TA = 25°C

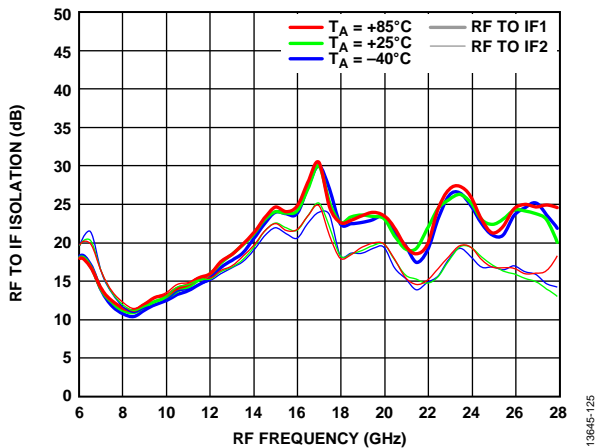

Figure 117. RF to IF Isolation vs. RF Frequency at Various Temperatures, IF = 100 MHz, LO Drive = 18 dBm

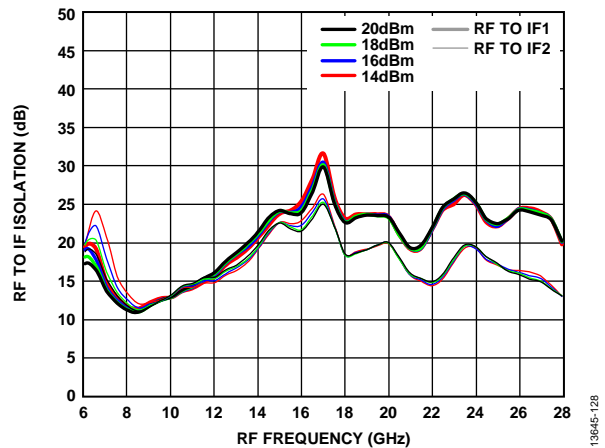

Figure 120. RF to IF Isolation vs. RF Frequency at Various LO Drives, IF = 100 MHz, TA = 25°C

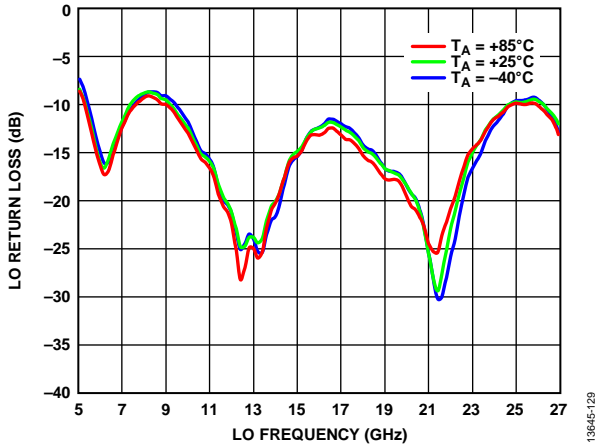

Figure 121. LO Return Loss vs. LO Frequency at Various Temperatures, LO Drive = 18 dBm

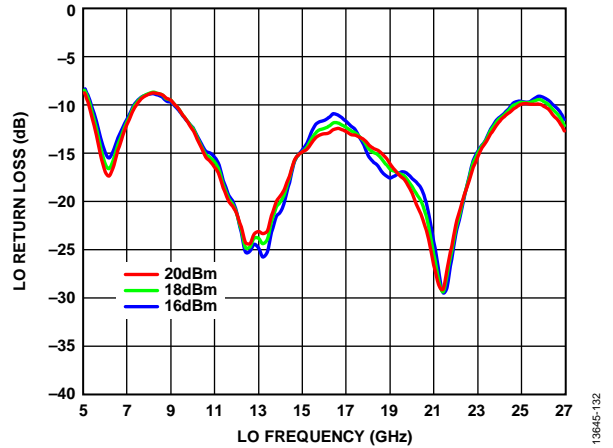

Figure 124. LO Return Loss vs. LO Frequency at Various LO Drives

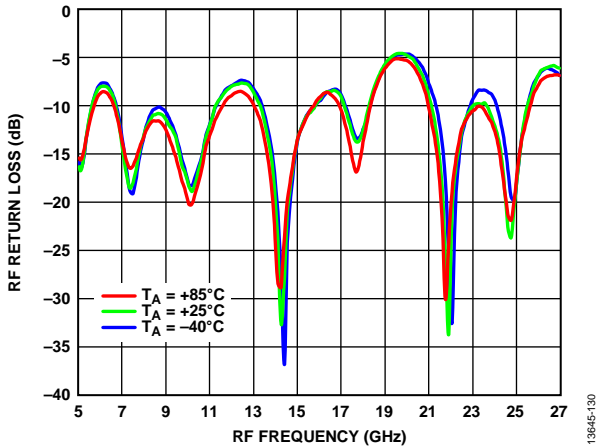

Figure 122. RF Return Loss vs. RF Frequency at Various Temperatures, LO Frequency = 16 GHz, LO Drive = 18 dBm

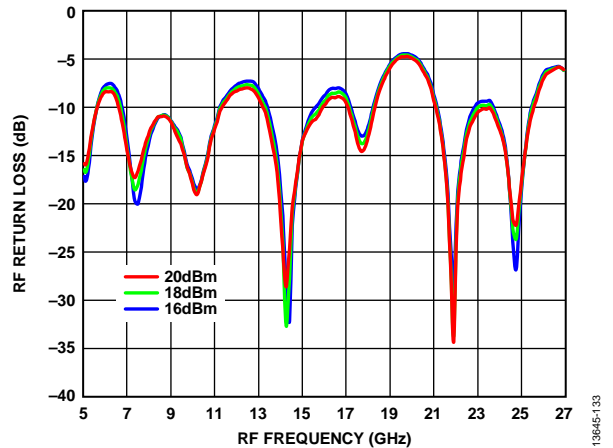

Figure 125. RF Return Loss vs. RF Frequency at Various LO Drives, LO Frequency = 16 GHz

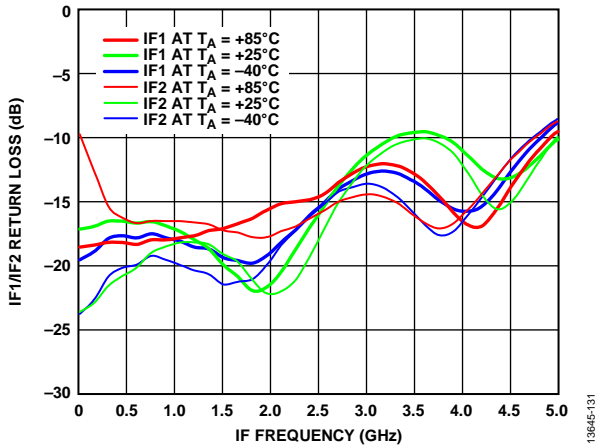

Figure 123. IF1/IF2 Return Loss vs. IF Frequency at Various Temperatures, LO Frequency = 16 GHz, LO Drive = 18 dBm

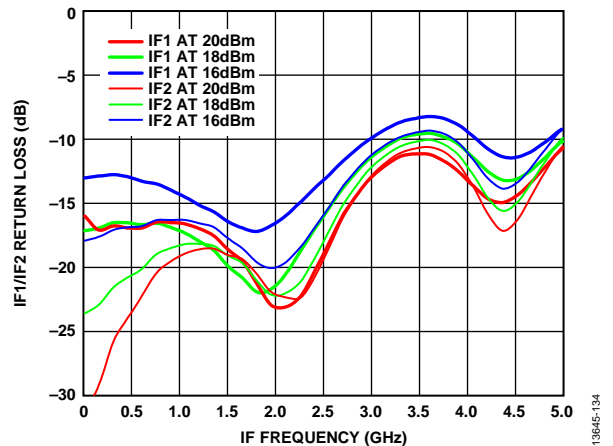

Figure 126. IF1/IF2 Return Loss vs. IF Frequency at Various LO Drives, LO Frequency = 16 GHz

IF BANDWIDTH PERFORMANCE: DOWNCONVERTER, LOWER SIDEBAND (HIGH-SIDE LO)

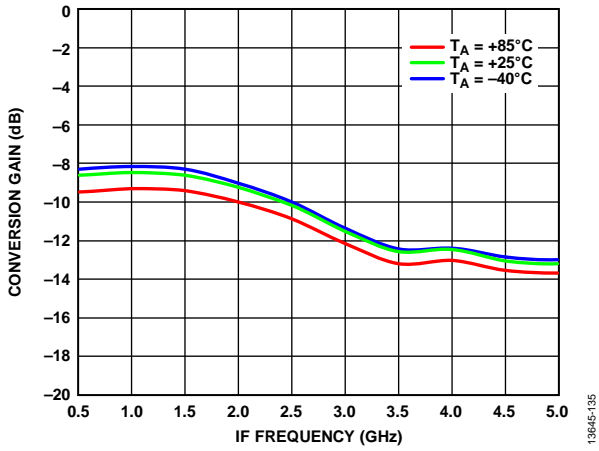

Figure 127. Conversion Gain vs. IF Frequency at Various Temperatures, LO Drive = 18 dBm at 16 GHz

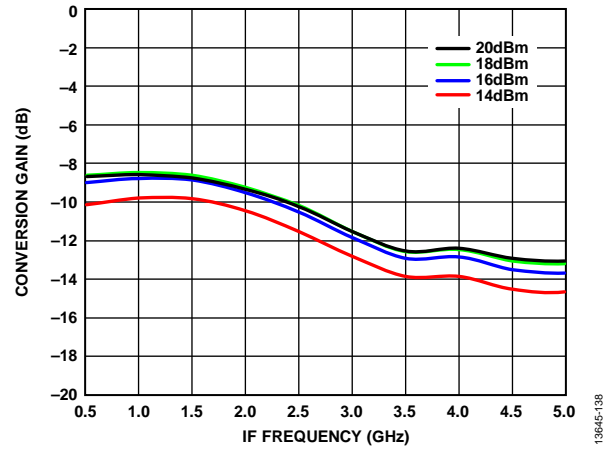

Figure 130. Conversion Gain vs. IF Frequency at Various LO Drives, LO Frequency = 16 GHz, $T_A = 25^\circ\text{C}$

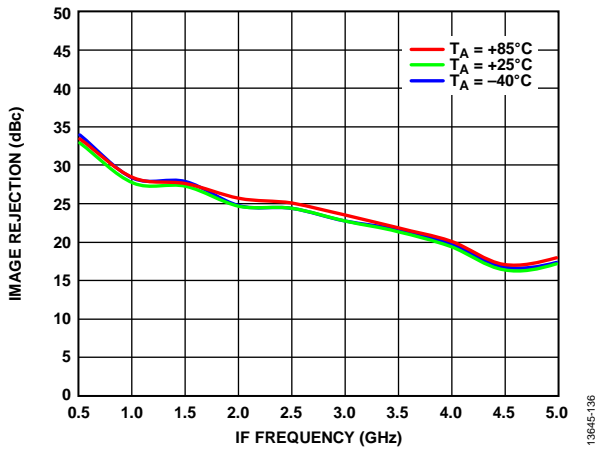

Figure 128. Image Rejection vs. IF Frequency at Various Temperatures, LO Drive = 18 dBm at 16 GHz

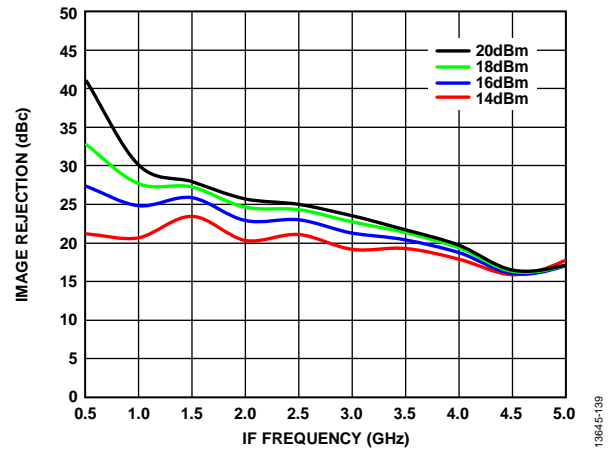

Figure 131. Image Rejection vs. IF Frequency at Various LO Drives, LO Frequency = 16 GHz, $T_A = 25^\circ\text{C}$

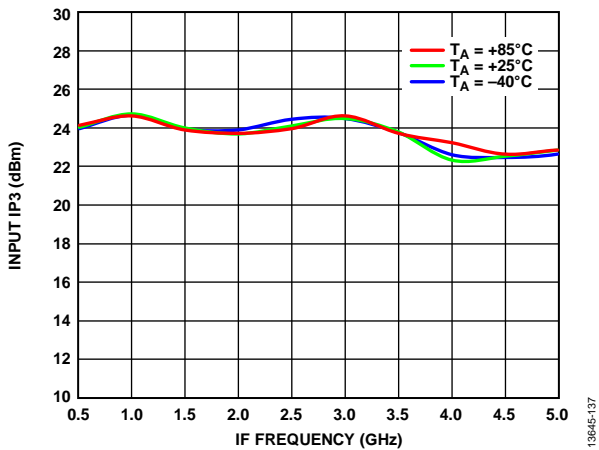

Figure 129. Input IP3 vs. IF Frequency at Various Temperatures, LO Drive = 18 dBm at 16 GHz

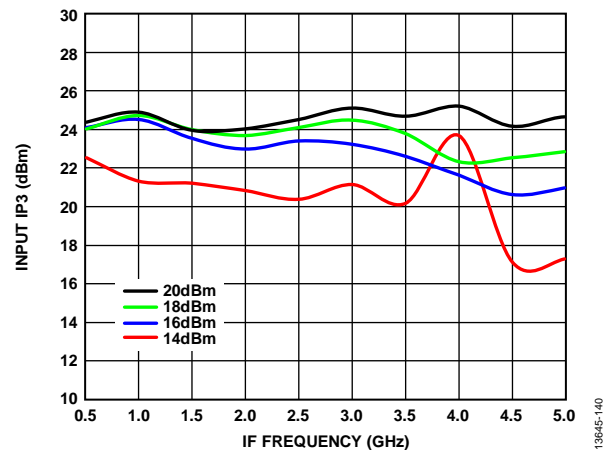

Figure 132. Input IP3 vs. IF Frequency at Various LO Drives, LO Frequency = 16 GHz, $T_A = 25^\circ\text{C}$

AMPLITUDE AND PHASE IMBALANCE PERFORMANCE: DOWNCONVERTER, LOWER SIDEBAND (HIGH-SIDE LO)

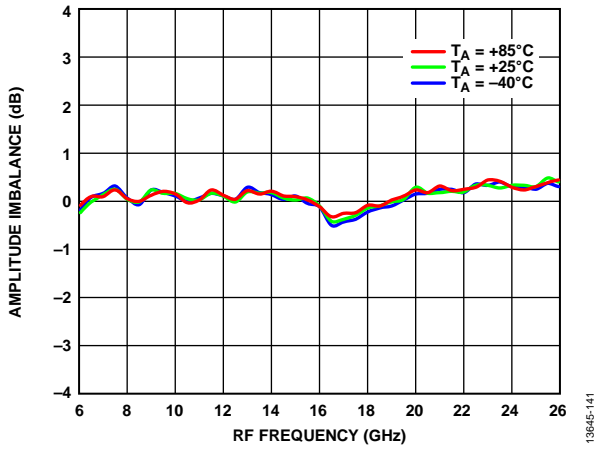

Figure 133. Amplitude Imbalance vs. RF Frequency at Various Temperatures, LO Drive = 18 dBm, IF = 100 MHz

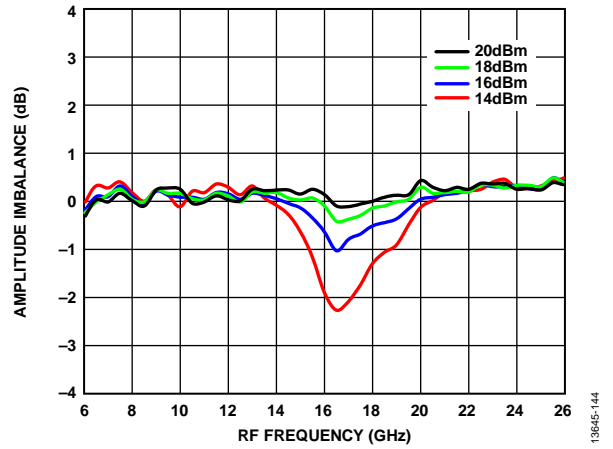

Figure 136. Amplitude Imbalance vs. RF Frequency at Various LO Drives, IF = 100 MHz, $T_A = 25^\circ\text{C}$

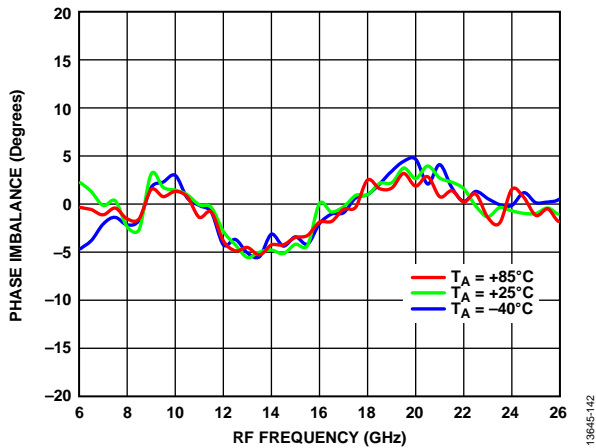

Figure 134. Phase Imbalance vs. RF Frequency at Various Temperatures, LO Drive = 18 dBm, IF = 100 MHz

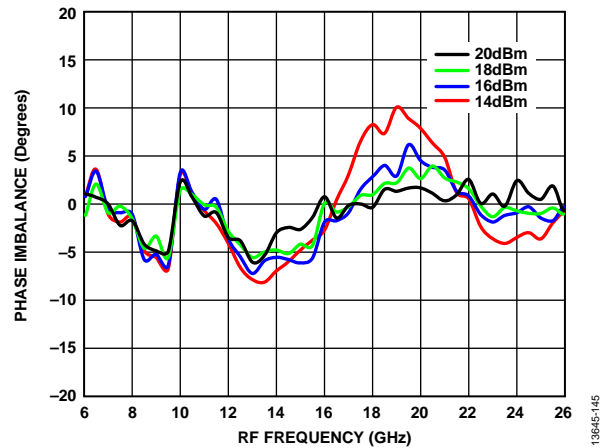

Figure 137. Phase Imbalance vs. RF Frequency at Various LO Drives, IF = 100 MHz, $T_A = 25^\circ\text{C}$

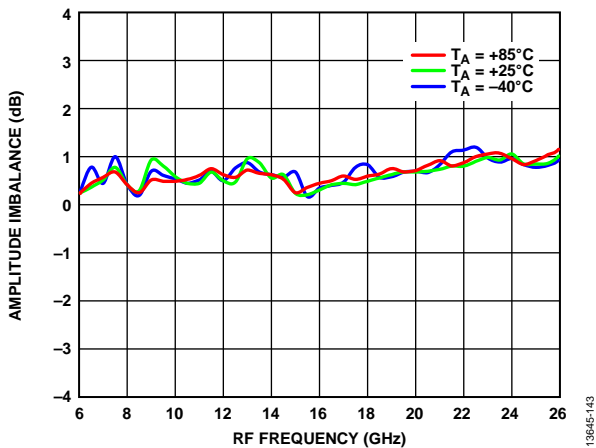

Figure 135. Amplitude Imbalance vs. RF Frequency at Various Temperatures, LO Drive = 18 dBm, IF = 2500 MHz

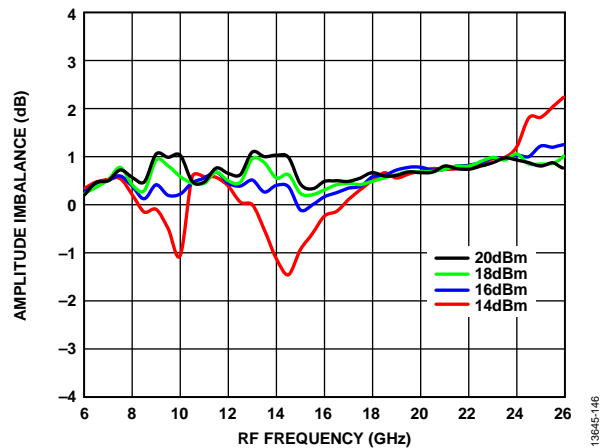

Figure 138. Amplitude Imbalance vs. RF Frequency at Various LO Drives, IF = 2500 MHz, $T_A = 25^\circ\text{C}$

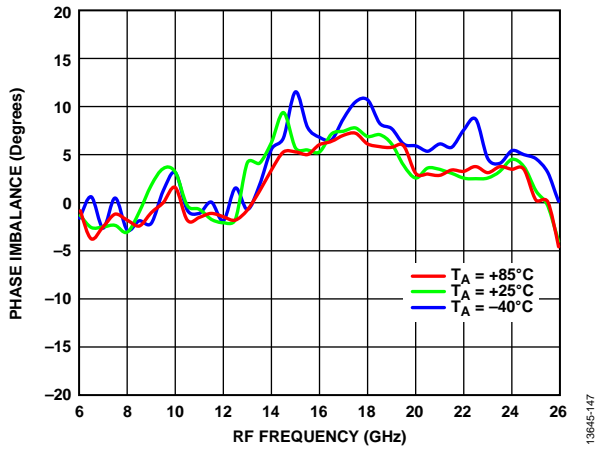

Figure 139. Phase Imbalance vs. RF Frequency at Various Temperatures, LO Drive = 18 dBm, IF = 2500 MHz

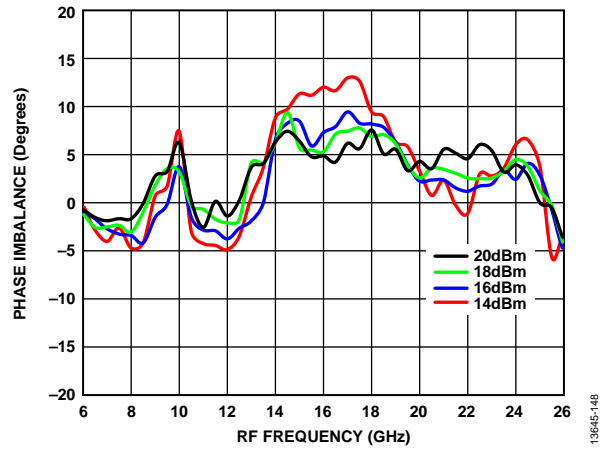

Figure 140. Phase Imbalance vs. RF Frequency at Various LO Drives, IF = 2500 MHz, T_A = 25°C

AMPLITUDE AND PHASE IMBALANCE PERFORMANCE: DOWNCONVERTER, UPPER SIDEBAND (LOW-SIDE LO)

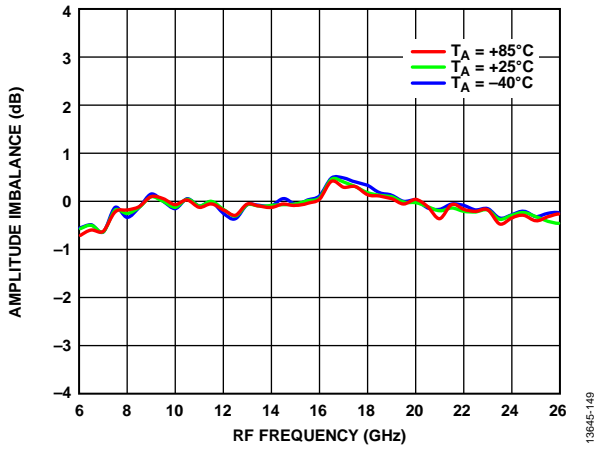

Figure 141. Amplitude Imbalance vs. RF Frequency at Various Temperatures, LO Drive = 18 dBm, IF = 100 MHz

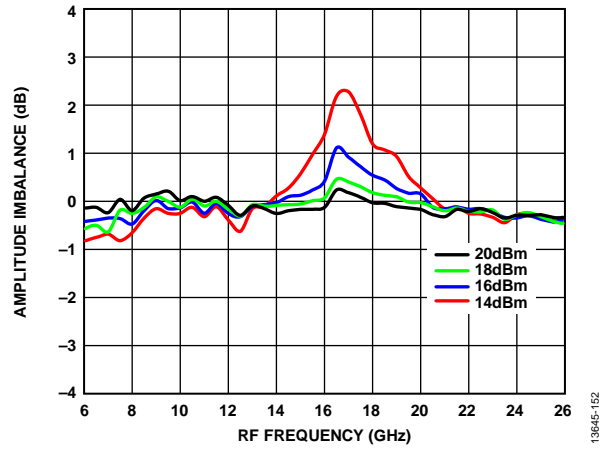

Figure 144. Amplitude Imbalance vs. RF Frequency at Various LO Drives, IF = 100 MHz, TA = 25°C

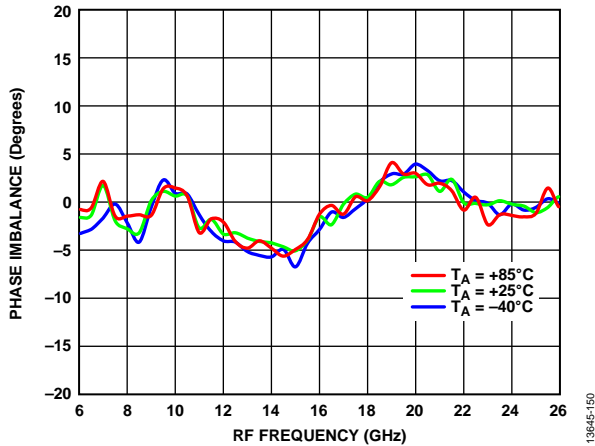

Figure 142. Phase Imbalance vs. RF Frequency at Various Temperatures, LO Drive = 18 dBm, IF = 100 MHz

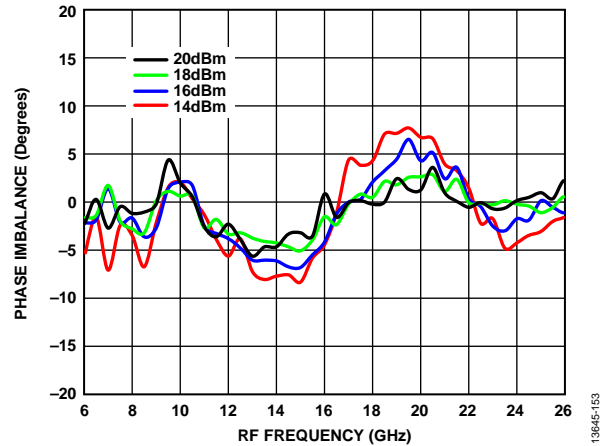

Figure 145. Phase Imbalance vs. RF Frequency at Various LO Drives, IF = 100 MHz, TA = 25°C

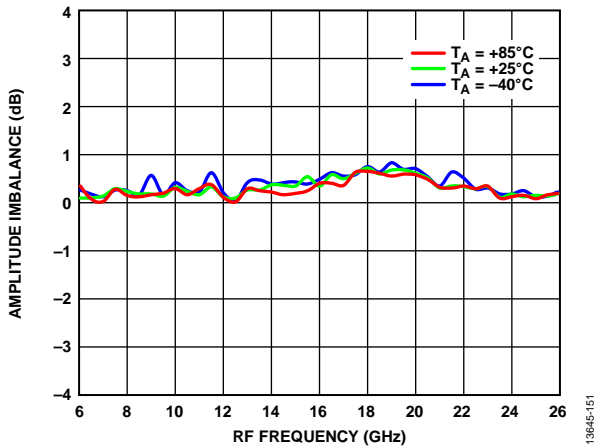

Figure 143. Amplitude Imbalance vs. RF Frequency at Various Temperatures, LO Drive = 18 dBm, IF = 2500 MHz

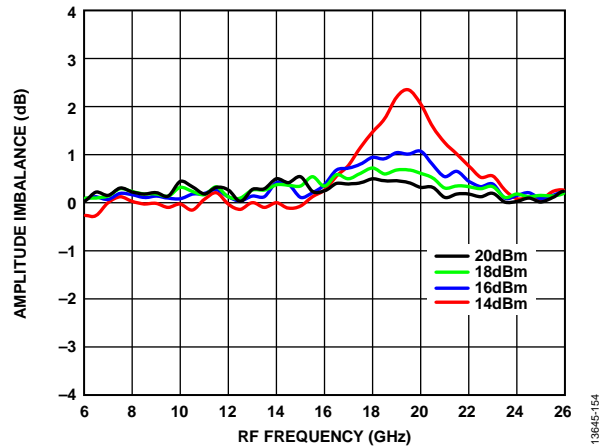

Figure 146. Amplitude Imbalance vs. RF Frequency at Various LO Drives, IF = 2500 MHz, TA = 25°C

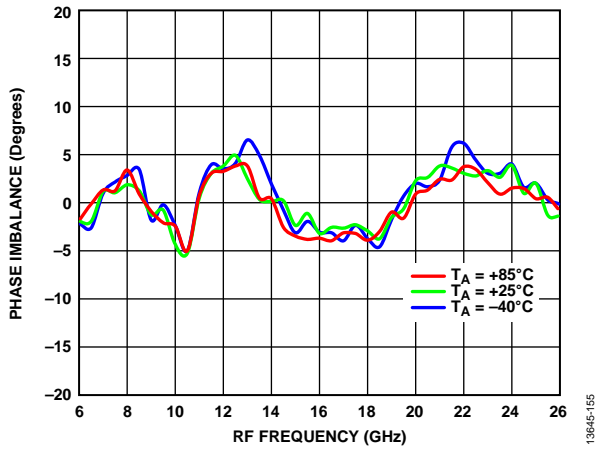

Figure 147. Phase Imbalance vs. RF Frequency at Various Temperatures, LO Drive = 18 dBm, IF = 2500 MHz

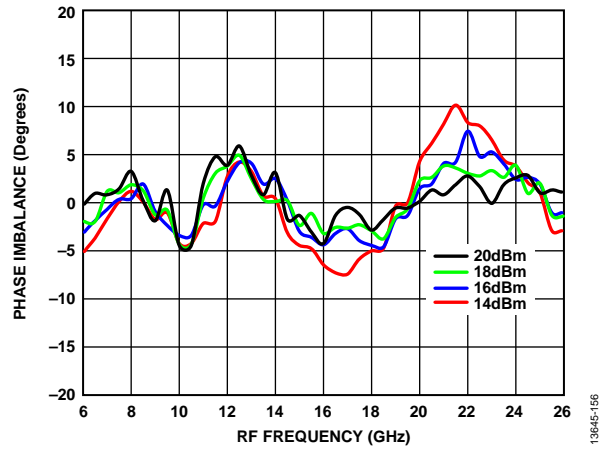

Figure 148. Phase Imbalance vs. RF Frequency at Various LO Drives, IF = 2500 MHz, $T_A = 25^\circ\text{C}$

SPURIOUS AND HARMONICS PERFORMANCE

N/A means not applicable.

LO Harmonics Isolation

LO power = 18 dBm, T_A = 25°C, and all values are in dBc below the input LO level measured at the RF port.

Table 5. N × LO Spur at RF Output

LO Frequency (GHz)	N × LO Spur at RF Port			
	1	2	3	4
6	37	47	57	37
8	40	52	53	40
10	46	61	62	46
12	47	68	79	47
14	46	68	72	46
16	39	77	N/A	39
18	37	78	N/A	37
20	39	60	N/A	39
22	41	55	N/A	40
24	46	N/A	N/A	46
26	45	N/A	N/A	45

Downconverter M × N Spurious Outputs

Mixer spurious products are measured in dBc from the IF output power level, unless otherwise specified. Spur values are (M × RF) – (N × LO).

IF = 100 MHz, RF = 6000 MHz, LO = 6100 MHz,
RF power = -10 dBm, LO power = 18 dBm, and T_A = 25°C.

M × RF		N × LO					
		0	1	2	3	4	5
M × RF	0	N/A	-4	+15	+18	+35	N/A
	1	+18	N/A	+23	+31	+41	+57
	2	+57	+49	+43	+53	+54	+72
	3	+87	+72	+62	+59	+63	+63
	4	+84	+86	+88	+80	+78	+80
	5	N/A	+84	+85	+88	+90	+88

IF = 100 MHz, RF = 16000 MHz, LO = 16100 MHz,
RF power = -10 dBm, LO power = 18 dBm, and T_A = 25°C.

M × RF		N × LO					
		0	1	2	3	4	5
M × RF	0	N/A	9	N/A	N/A	N/A	N/A
	1	28	N/A	N/A	N/A	N/A	N/A
	2	N/A	87	75	84	N/A	N/A
	3	N/A	N/A	86	75	90	N/A
	4	N/A	N/A	N/A	88	95	88
	5	N/A	N/A	N/A	N/A	87	96

IF = 100 MHz, RF = 26000 MHz, LO = 26100 MHz,
RF power = -10 dBm, LO power = 18 dBm, and T_A = 25°C.

M × RF		N × LO					
		0	1	2	3	4	5
M × RF	0		7	N/A	N/A	N/A	N/A
	1	21	N/A	46	N/A	N/A	N/A
	2	N/A	84	69	85	N/A	N/A
	3	N/A	N/A	82	83	82	N/A
	4	N/A	N/A	N/A	81	92	81
	5	N/A	N/A	N/A	N/A	81	94

IF = 2500 MHz, RF = 6000 MHz, LO = 8500 MHz,
RF power = -10 dBm, LO power = 18 dBm, and T_A = 25°C.

M × RF		N × LO					
		0	1	2	3	4	5
M × RF	0		-2	+26	+22	0	0
	1	+7	N/A	+21	+41	0	0
	2	+73	+71	+65	+75	+86	0
	3	+85	+77	+71	+77	+85	+85
	4	+83	+85	+90	+93	+88	+85
	5	0	+84	+88	+93	+91	+88

IF = 2500 MHz, RF = 16000 MHz, LO = 18500 MHz,
RF power = -10 dBm, LO power = 18 dBm, and T_A = 25°C.

M × RF		N × LO					
		0	1	2	3	4	5
M × RF	0	N/A	1	N/A	N/A	N/A	N/A
	1	13	N/A	40	N/A	N/A	N/A
	2	N/A	78	65	79	N/A	N/A
	3	N/A	N/A	85	88	84	N/A
	4	N/A	N/A	N/A	90	87	N/A
	5	N/A	N/A	N/A	85	89	87

IF = 2500 MHz, RF = 26000 MHz, LO = 28500 MHz,
RF power = -10 dBm, LO power = 18 dBm, and T_A = 25°C.

M × RF		N × LO					
		0	1	2	3	4	5
M × RF	0	N/A	N/A	N/A	N/A	N/A	N/A
	1	11	N/A	N/A	N/A	N/A	N/A
	2	N/A	82	73	N/A	N/A	N/A
	3	N/A	N/A	85	79	N/A	N/A
	4	N/A	N/A	N/A	85	86	N/A
	5	N/A	N/A	N/A	N/A	83	87

IF = 5000 MHz, RF = 6000 MHz, LO = 11000 MHz,
RF power = -10 dBm, LO power = 18 dBm, and T_A = 25°C.

		N × LO					
		0	1	2	3	4	5
M × RF	0	N/A	4	23	N/A	N/A	N/A
	1	7	N/A	30	N/A	N/A	N/A
	2	73	92	68	84	N/A	N/A
	3	86	82	83	83	82	N/A
	4	82	87	92	87	86	N/A
	5	N/A	83	88	88	84	83

IF = 100 MHz, RF = 16000 MHz, LO = 16100 MHz,
RF power = -10 dBm, LO power = 18 dBm, and T_A = 25°C.

		N × LO					
		0	1	2	3	4	5
M × IF	0		2	37	N/A	N/A	N/A
	1	62	N/A	47	N/A	N/A	N/A
	2	94	58	79	N/A	N/A	N/A
	3	95	80	80	N/A	N/A	N/A
	4	95	83	78	N/A	N/A	N/A
	5	93	81	80	N/A	N/A	N/A

IF = 5000 MHz, RF = 16000 MHz, LO = 21000 MHz,
RF power = -10 dBm, LO power = 18 dBm, and T_A = 25°C.

		N × LO					
		0	1	2	3	4	5
M × RF	0	N/A	3	N/A	N/A	N/A	N/A
	1	11	N/A	40	N/A	N/A	N/A
	2	N/A	83	85	N/A	N/A	N/A
	3	N/A	N/A	85	82	N/A	N/A
	4	N/A	N/A	82	81	84	N/A
	5	N/A	N/A	N/A	82	88	80

IF = 100 MHz, RF = 26000 MHz, LO = 26100 MHz,
RF power = -10 dBm, LO power = 18 dBm, and T_A = 25°C.

		N × LO					
		0	1	2	3	4	5
M × IF	0		4	N/A	N/A	N/A	N/A
	1	58	N/A	N/A	N/A	N/A	N/A
	2	93	57	N/A	N/A	N/A	N/A
	3	92	80	N/A	N/A	N/A	N/A
	4	91	82	N/A	N/A	N/A	N/A
	5	90	82	N/A	N/A	N/A	N/A

IF = 5000 MHz, RF = 26000 MHz, LO = 31000 MHz,
RF power = -10 dBm, LO power = 18 dBm, and T_A = 25°C.

		N × LO					
		0	1	2	3	4	5
M × RF	0	N/A	N/A	N/A	N/A	N/A	N/A
	1	5	N/A	N/A	N/A	N/A	N/A
	2	N/A	58	43	N/A	N/A	N/A
	3	N/A	N/A	66	67	N/A	N/A
	4	N/A	N/A	N/A	79	78	N/A
	5	N/A	N/A	N/A	N/A	82	75

IF = 2500 MHz, RF = 6000 MHz, LO = 8500 MHz,
RF power = -10 dBm, LO power = 18 dBm, and T_A = 25°C.

		N × LO					
		0	1	2	3	4	5
M × IF	0	N/A	4	11	14	50	0
	1	14	0	15	30	43	58
	2	83	81	70	66	82	68
	3	71	90	78	69	80	75
	4	90	92	86	82	82	78
	5	85	91	89	84	82	82

Upconverter M × N Spurious Outputs

Mixer spurious products are measured in dBc from the RF output power level, unless otherwise specified. Spur values are (M × IF) – (N × LO).

IF = 100 MHz, RF = 6000 MHz, LO = 6100 GHz,
RF power = -10 dBm, LO power = 18 dBm, and T_A = 25°C.

		N × LO					
		0	1	2	3	4	5
M × IF	0	N/A	-2	+10	+16	+18	+32
	1	+56	N/A	+16	+14	+31	+33
	2	+93	+46	+45	+44	+51	+56
	3	+92	+51	+62	+49	+57	+62
	4	N/A	-2	+10	+16	+18	+32
	5	+56	N/A	+16	+14	+31	+33

IF = 2500 MHz, RF = 16000 MHz, LO = 18500 MHz,
RF power = -10 dBm, LO power = 18 dBm, and T_A = 25°C.

		N × LO					
		0	1	2	3	4	5
M × IF	0	N/A	N/A	27	N/A	N/A	N/A
	1	15	N/A	52	N/A	N/A	N/A
	2	92	70	78	N/A	N/A	N/A
	3	87	88	83	N/A	N/A	N/A
	4	89	87	83	N/A	N/A	N/A
	5	88	93	80	N/A	N/A	N/A

IF = 2500 MHz, RF = 26000 MHz, LO = 28500 MHz,
RF power = -10 dBm, LO power = 18 dBm, and T_A = 25°C.

		N × LO					
		0	1	2	3	4	5
M × IF	0	12	N/A	N/A	N/A	N/A	N/A
	1	50	61	N/A	N/A	N/A	N/A
	2	70	66	N/A	N/A	N/A	N/A
	3	86	82	N/A	N/A	N/A	N/A
	4	83	83	N/A	N/A	N/A	N/A
	5	12	N/A	N/A	N/A	N/A	N/A

IF = 5000 MHz, RF = 16000 MHz, LO = 21000 MHz,
RF power = -10 dBm, LO power = 18 dBm, and T_A = 25°C.

		N × LO					
		0	1	2	3	4	5
M × IF	0	N/A	-3	N/A	N/A	N/A	N/A
	1	+1	N/A	+62	N/A	N/A	N/A
	2	+81	+72	+74	N/A	N/A	N/A
	3	+82	+87	+81	N/A	N/A	N/A
	4	+79	+89	+81	N/A	N/A	N/A
	5	+76	+88	+84	+65	N/A	N/A

IF = 5000 MHz, RF = 6000 MHz, LO = 11000 MHz,
RF power = -10 dBm, LO power = 18 dBm, and T_A = 25°C.

		N × LO					
		0	1	2	3	4	5
M × IF	0	N/A	6	23	34	N/A	N/A
	1	5	N/A	17	47	70	N/A
	2	80	91	65	79	75	N/A
	3	81	89	85	83	84	72
	4	80	86	91	83	82	75
	5	77	83	89	85	82	82

IF = 5000 MHz, RF = 26000 MHz, LO = 31000 MHz,
RF power = -10 dBm, LO power = 18 dBm, and T_A = 25°C.

		N × LO					
		0	1	2	3	4	5
M × IF	0	N/A	+3	N/A	N/A	N/A	N/A
	1	-7	N/A	N/A	N/A	N/A	N/A
	2	+41	+42	N/A	N/A	N/A	N/A
	3	+77	+78	N/A	N/A	N/A	N/A
	4	+76	+81	N/A	N/A	N/A	N/A
	5	+72	+84	+64	N/A	N/A	N/A

THEORY OF OPERATION

The HMC8191 is a passive, wideband, I/Q MMIC mixer that can be used either as an image reject mixer for receiver operations, or as a single-sideband upconverter for transmitter operations. With an RF and LO range of 6 GHz to 26.5 GHz, and an IF bandwidth of dc to 5 GHz, the HMC8191 is ideal for applications requiring wide frequency range, excellent RF performance, and a simple design with fewer components and a small PCB footprint. A single HMC8191 can replace multiple narrow-band mixers in a design.

The inherent I/Q architecture of the HMC8191 offers excellent image rejection and thereby eliminates the need for expensive filtering for unwanted sidebands. The double balanced architecture of the mixer also provides excellent LO to RF isolation and LO to IF isolation, and reduces the effect of LO leakage to ensure signal integrity.

Because the HMC8191 is a passive mixer, the HMC8191 does not require any dc power sources. It offers a lower noise figure compared to an active mixer, ensuring superior dynamic range for high performance and precision applications.

The HMC8191 is fabricated on a GaAs MESFET process and uses Analog Devices mixer cells and a 90° hybrid. The HMC8191 is available in a compact, 4 mm × 4 mm, 24-terminal LCC package and operates over a -40°C to +85°C temperature range. An evaluation board for the HMC8191 is also available from the Analog Devices website.

For both upconversion and downconversion, an external 90° hybrid is required. See the Applications Information section for details to interface with an external 90° hybrid.

APPLICATIONS INFORMATION

Figure 149 shows the typical application circuit for the HMC8191. To select the appropriate sideband, an external 90° hybrid is needed. For applications not requiring operation to dc, use an off-chip dc blocking capacitor. For applications that require the LO signal at the output to be suppressed, use a bias tee or RF feed as shown in Figure 149. Ensure that the source or sink current used for LO suppression is <3 mA for each IF port to prevent damage to the device. The common-mode voltage for each IF port is 0 V.

To select the upper sideband when using as an upconverter, connect the IF1 pin to the 90° port of the hybrid, and connect the IF2 pin to the 0° port of the hybrid. To select the lower

sideband, connect IF1 to the 0° port of the hybrid and IF2 to the 90° port of the hybrid. The input is from the sum port of the hybrid and the difference port is 50 Ω terminated.

To select the upper sideband (low-side LO) when using as a downconverter, connect the IF1 pin to the 0° port of the hybrid, and connect the IF2 pin to the 90° port of the hybrid. To select the lower sideband (high-side LO), connect the IF1 pin to the 90° port of the hybrid and IF2 to the 0° port of the hybrid. The output is from the sum port of the hybrid, and the difference port is 50 Ω terminated.

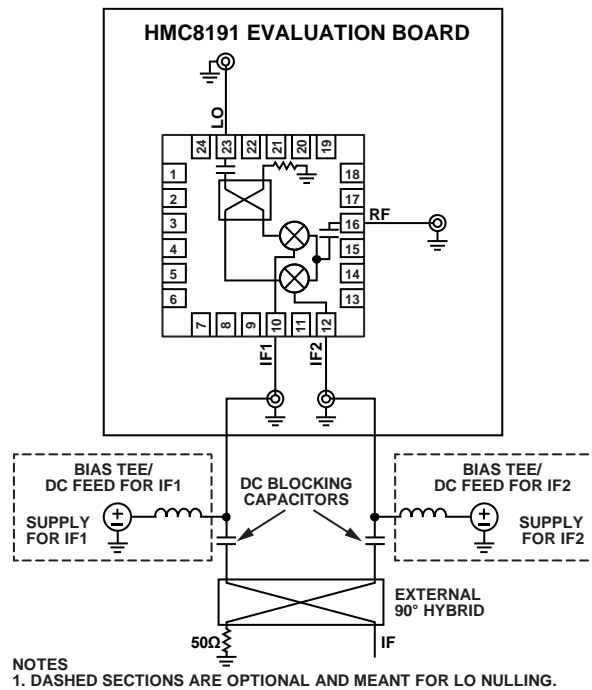

Figure 149. Typical Application Circuit

RF AND LO PERFORMANCE ABOVE 26 GHz

Figure 150 and Figure 151 shows the RF performance above 26 GHz for both upconversion and downconversion. The data was taken at an IF frequency of 100 MHz and LO power at 18 dBm.

Note that this performance is typical and not guaranteed.

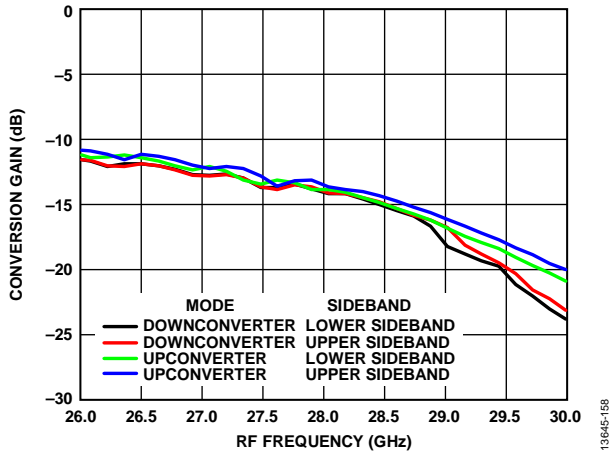

Figure 150. Conversion Gain vs. RF Frequency above 26 GHz at $T_A = 25^\circ\text{C}$ for Upper and Lower Sidebands, Upconversion and Downconversion, LO Drive = 18 dBm, IF = 100 MHz, External Hybrid Not Calibrated

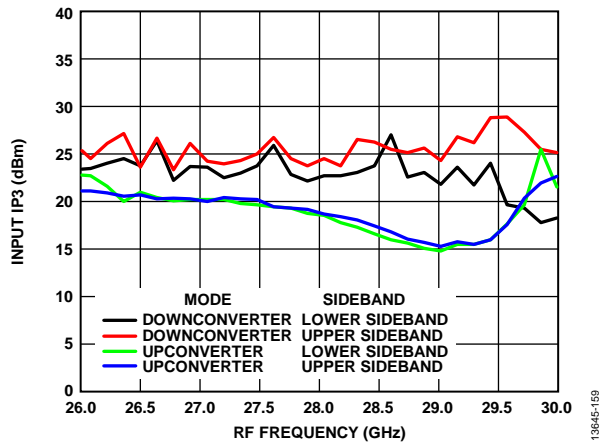

Figure 151. Input IP3 vs. RF Frequency above 26 GHz at $T_A = 25^\circ\text{C}$ for Upper and Lower Sidebands, Upconversion and Downconversion, LO Drive = 18 dBm, IF = 100 MHz, External Hybrid Not Calibrated

IF BANDWIDTH ABOVE 5 GHz

Figure 152, Figure 153, and Figure 154 show the IF performance above 5 GHz. The data for these figures has been taken in upconverter configuration at LO frequency and power of 16 GHz and 18 dBm, respectively.

Note that this performance is typical and not guaranteed.

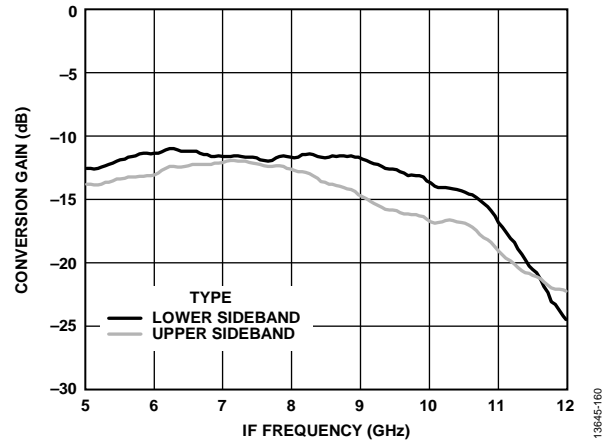

Figure 152. Conversion Gain vs. IF Frequency above 5 GHz at $T_A = 25^\circ\text{C}$ for Upper and Lower Sidebands, LO Drive = 18 dBm at 16 GHz, Calibration to the Connector of the Evaluation Board

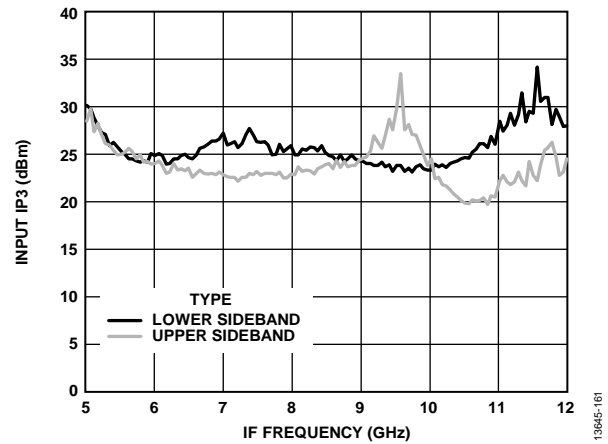

Figure 153. Input IP3 vs. IF Frequency above 5 GHz at $T_A = 25^\circ\text{C}$ for Upper and Lower Sidebands, LO Drive = 18 dBm at 16 GHz, Calibration to the Connector of the Evaluation Board

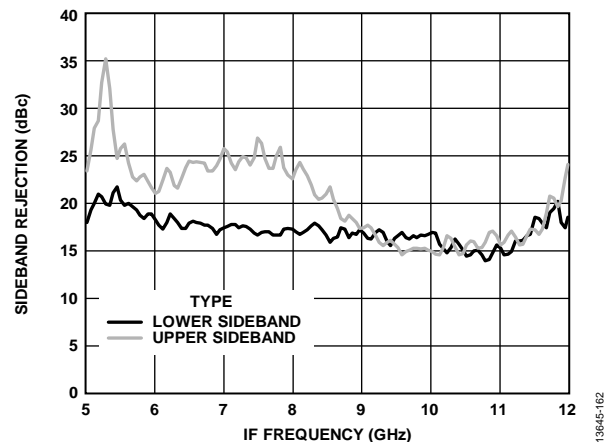

Figure 154. Sideband Rejection vs. IF Frequency above 5 GHz at $T_A = 25^\circ\text{C}$ for Upper and Lower Sidebands, LO Drive = 18 dBm at 16 GHz, Calibration to the Connector of the Evaluation Board

SOLDERING INFORMATION AND RECOMMENDED LAND PATTERN

Figure 155 shows the recommended land pattern for the HMC8191. The HMC8191 is contained in a 4 mm × 4 mm 24-terminal, ceramic, LCC package, with an exposed ground pad (EPAD). This pad is internally connected to the ground of the chip. To minimize thermal impedance and ensure electrical performance, solder the pad to the low impedance ground plane on the PCB. It is recommended that the ground planes on all layers under the pad be stitched together with vias, to further reduce thermal impedance.

The land pattern on the HMC8191 evaluation board provides a simulated thermal resistance (θ_{JA}) of 38.3°C/W.

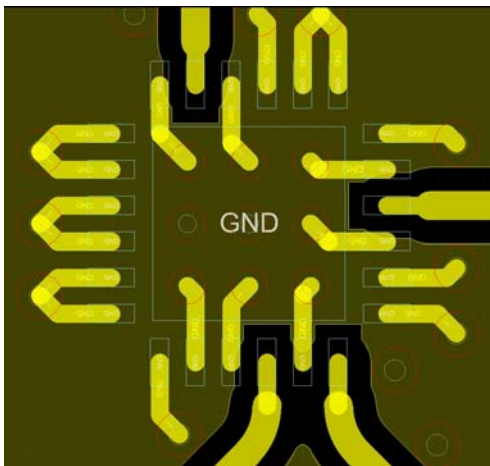

Figure 155. Evaluation Board Layout for the HMC8191 Package

EVALUATION BOARD INFORMATION

The EV1HMC8191LC4 evaluation board PCB used in the application must use RF circuit design techniques. Signal lines must have a 50 Ω impedance and connect the package ground leads and exposed pad directly to the ground plane similar to the setup shown in Figure 156. Use a sufficient number of via holes to connect the top and bottom ground planes.

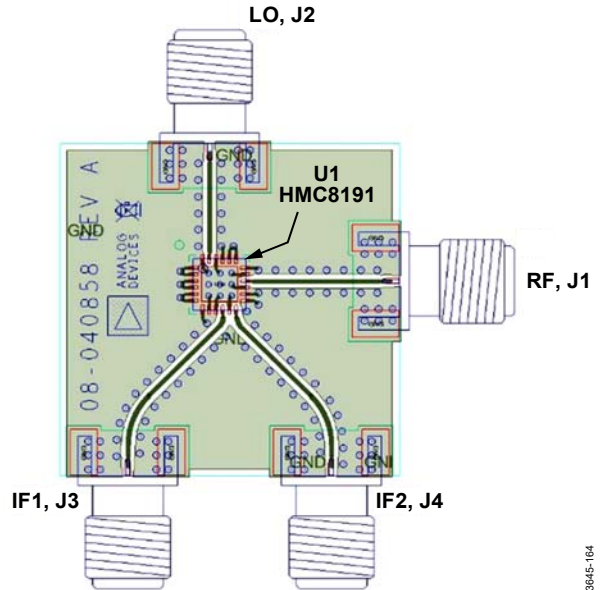

Figure 156. EV1HMC8191LC4 Evaluation Board PCB, Top Layer

Table 6. Bill of Materials for the EV1HMC8191LC4¹ Evaluation Board PCB

Quantity	Reference Designator	Description	Manufacturer	Part Number
1		PCB, EV1HMC8191LC4 ²	Analog Devices	08_040858a
4	J1 to J4	2.92 mm SMA connectors, SRI Connector Gage	SRI Connector Gage Co.	25-146-1000-92
1	U1	Device under test, HMC8191	Analog Devices	HMC8191

¹ Reference this number when ordering the evaluation board PCB.

² Circuit board material: Rogers 4350.