

## FEATURES

**Conversion loss: 8.5 dB**  
**LO to RF isolation: 37 dB**  
**Input IP3: 20 dBm**  
**RoHS compliant, 2.90 mm × 2.90 mm, 12-terminal LCC package**

## APPLICATIONS

**Microwave and very small aperture terminal (VSAT) radios**  
**Test equipment**  
**Military electronic warfare (EW); electronic countermeasure (ECM); and command, control, communications and intelligence (C3I)**

## GENERAL DESCRIPTION

The HMC554ALC3B is a general-purpose, double balanced mixer in a leadless RoHS compliant leadless chip carrier (LCC) package that can be used as an upconverter or downconverter between 10 GHz and 20 GHz. This mixer is fabricated in a gallium arsenide (GaAs) metal semiconductor field effect transistor (MESFET) process and requires no external

## FUNCTIONAL BLOCK DIAGRAM

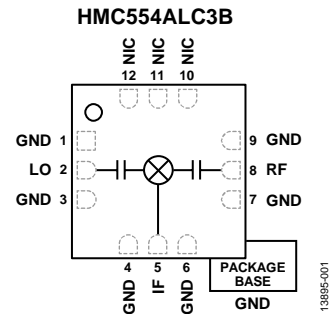

Figure 1.

components or matching circuitry. The HMC554ALC3B provides excellent local oscillator (LO) to RF and LO to intermediate frequency (IF) isolation due to optimized balun structures. The RoHS compliant HMC554ALC3B eliminates the need for wire bonding and is compatible with high volume surface-mount manufacturing techniques.

**TABLE OF CONTENTS**

Features .....	1	Downconverter Performance, IF = 3000 MHz .....	10
Applications.....	1	Upconverter Performance, IF <sub>IN</sub> = 100 MHz .....	13
Functional Block Diagram .....	1	Upconverter Performance, IF <sub>IN</sub> = 3000 MHz .....	16
General Description .....	1	Isolation and Return Loss .....	19
Revision History .....	2	IF Bandwidth—Downconverter.....	21
Specifications.....	3	Spurious and Harmonics Performance .....	23
Absolute Maximum Ratings.....	4	Theory of Operation .....	24
Thermal Resistance .....	4	Applications Information .....	25
ESD Caution.....	4	Typical Application Circuit.....	25
Pin Configuration and Function Descriptions.....	5	Evaluation PCB Information .....	25
Interface Schematics.....	5	Outline Dimensions .....	26
Typical Performance Characteristics .....	6	Ordering Guide .....	26
Downconverter Performance, IF = 100 MHz.....	6		

**REVISION HISTORY**

**10/2019—Rev. 0 to Rev. A**

Changes to 10 GHz to 20 GHz Performance, Downconverter, Input 1 dB Compression Point Parameter, Table 1 and 12 GHz to 16 GHz Performance, Downconverter, Input 1 dB Compression Point Parameter, Table 1 .....	3
Changes to Figure 13 and Figure 15.....	7
Changes to Figure 27 and Figure 30.....	10

**4/2018—Revision 0: Initial Version**

## SPECIFICATIONS

$T_A = 25^\circ\text{C}$ , IF = 100 MHz, LO = 13 dBm, upper side band. All measurements performed as a downconverter, unless otherwise noted, on the evaluation printed circuit board (PCB).

**Table 1.**

Parameter	Symbol	Min	Typ	Max	Unit
<b>FREQUENCY</b>					
RF Pin		10		20	GHz
IF Pin		DC		6	GHz
LO Pin		10		20	GHz
<b>LO AMPLITUDE</b>					
		9	13	15	dBm
<b>10 GHz TO 20 GHz PERFORMANCE</b>					
Downconverter					
Conversion Loss			8.5	11.5	dB
Single Sideband Noise Figure	SSB NF		9.5		dB
Input Third-Order Intercept	IP3	19	20		dBm
Input 1 dB Compression Point	P1dB		10		dBm
Input Second-Order Intercept	IP2		46		dBm
Upconverter					
Conversion Loss			7		dB
Input Third-Order Intercept	IP3		19.5		dBm
Input 1 dB Compression Point	P1dB		10		dBm
Isolation					
RF to IF		24	41		dB
LO to RF		25	37		dB
LO to IF		23	41		dB
<b>12 GHz TO 16 GHz PERFORMANCE</b>					
Downconverter					
Conversion Loss			8		dB
Single Sideband Noise Figure	SSB NF		9		dB
Input Third-Order Intercept	IP3	16	19.5		dBm
Input 1 dB Compression Point	P1dB		9.5		dBm
Input Second-Order Intercept	IP2		45		dBm
Upconverter					
Conversion Loss			6.5		dB
Input Third-Order Intercept	IP3		18		dBm
Input 1 dB Compression Point	P1dB		10		dBm

## ABSOLUTE MAXIMUM RATINGS

Table 2.

Parameter	Rating
RF Input Power	25 dBm
LO Input Power	26 dBm
IF Input Power	25 dBm
IF Source/Sink Current	3 mA
Reflow Temperature	260°C
Maximum Junction Temperature	175°C
Continuous Power Dissipation, $P_{DISS}$ ( $T_A = 85^\circ\text{C}$ , Derate 3.7 mW/ $^\circ\text{C}$ Above 85°C)	333 mW
Operating Temperature Range	-40°C to +85°C
Storage Temperature Range	-65°C to +150°C
Electrostatic Discharge (ESD) Sensitivity	
Human Body Model (HBM)	250 V; Class 0B
Field Induced Charged Device Model (FICDM)	1250 V; Class IV

Stresses at or above those listed under Absolute Maximum Ratings may cause permanent damage to the product. This is a stress rating only; functional operation of the product at these or any other conditions above those indicated in the operational section of this specification is not implied. Operation beyond the maximum operating conditions for extended periods may affect product reliability.

## THERMAL RESISTANCE

Thermal performance is directly linked to PCB design and operating environment. Careful attention to PCB thermal design is required.

$\theta_{JA}$  is the natural convection junction to ambient thermal resistance measured in a one cubic foot sealed enclosure.  $\theta_{JC}$  is the junction to case thermal resistance.

Table 3. Thermal Resistance

Package Type	$\theta_{JA}$	$\theta_{JC}$	Unit
E-12-4 <sup>1</sup>	120	195	$^\circ\text{C}/\text{W}$

<sup>1</sup> Test Condition 1: JEDEC standard JESD51-2.

## ESD CAUTION



**ESD (electrostatic discharge) sensitive device.** Charged devices and circuit boards can discharge without detection. Although this product features patented or proprietary protection circuitry, damage may occur on devices subjected to high energy ESD. Therefore, proper ESD precautions should be taken to avoid performance degradation or loss of functionality.

# PIN CONFIGURATION AND FUNCTION DESCRIPTIONS

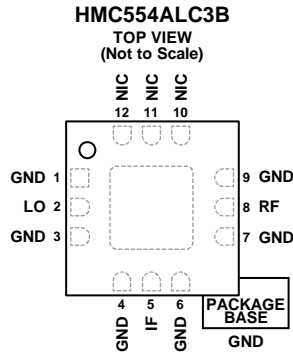

**NOTES**  
 1. NOT INTERNALLY CONNECTED. THESE PINS CAN BE CONNECTED TO RF/DC GROUND. PERFORMANCE IS NOT AFFECTED.  
 2. EXPOSED PAD. THE EXPOSED PAD MUST BE CONNECTED TO RF/DC GROUND.

13895-002

Figure 2. Pin Configuration

Table 4. Pin Function Descriptions

Pin No.	Mnemonic	Description
1, 3, 4, 6, 7, 9	GND	Ground. These pins and package bottom must be connected to RF/dc ground.
2	LO	LO Port. This pin is ac-coupled and matched to 50 Ω.
5	IF	IF Port. This pin is dc-coupled. For applications not requiring operation to dc, dc block this port externally using a series capacitor of a value chosen to pass the necessary IF frequency range. For operation to dc, this pin must not source/sink more than 3 mA of current or die malfunction and possible die failure may result.
8	RF	RF Port. This pin is ac-coupled and matched to 50 Ω.
10, 11, 12	NIC EPAD	Not Internally Connected. These pins can be connected to RF/dc ground. Performance is not affected. Exposed Pad. The exposed pad must be connected to RF/dc ground.

## INTERFACE SCHEMATICS



Figure 3. GND Interface Schematic

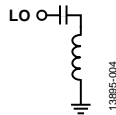

Figure 4. LO Interface Schematic

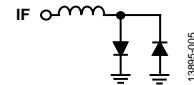

Figure 5. IF Interface Schematic

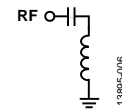

Figure 6. RF Interface Schematic

TYPICAL PERFORMANCE CHARACTERISTICS

DOWNCONVERTER PERFORMANCE, IF = 100 MHz

Upper Sideband (Low-Side LO)

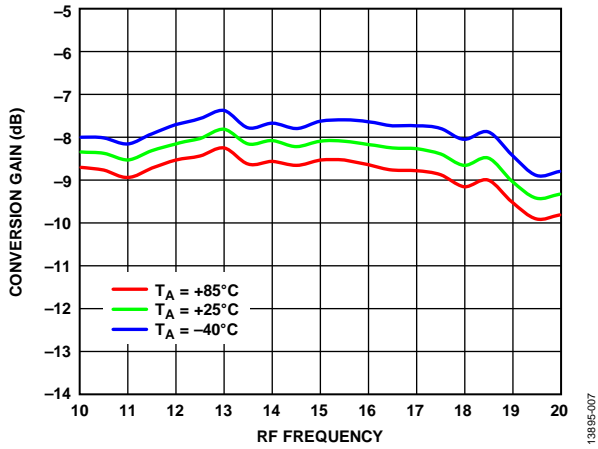

Figure 7. Conversion Gain vs. RF Frequency at Various Temperatures, LO = 13 dBm

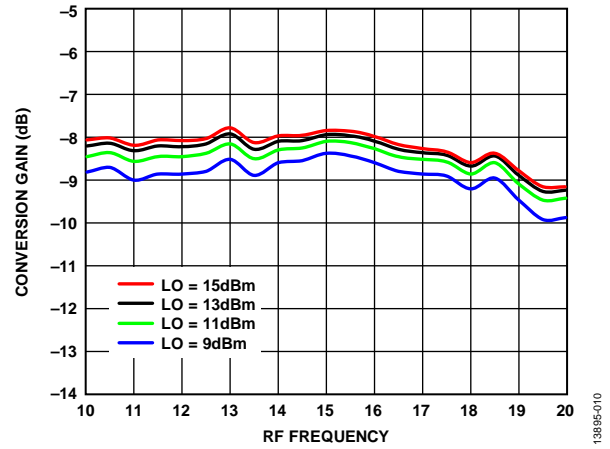

Figure 10. Conversion Gain vs. RF Frequency at Various LO Power Levels, TA = 25°C

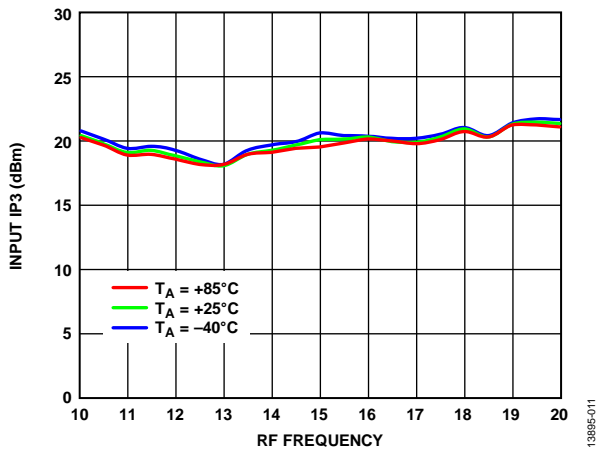

Figure 8. Input IP3 vs. RF Frequency at Various Temperatures, LO = 13 dBm

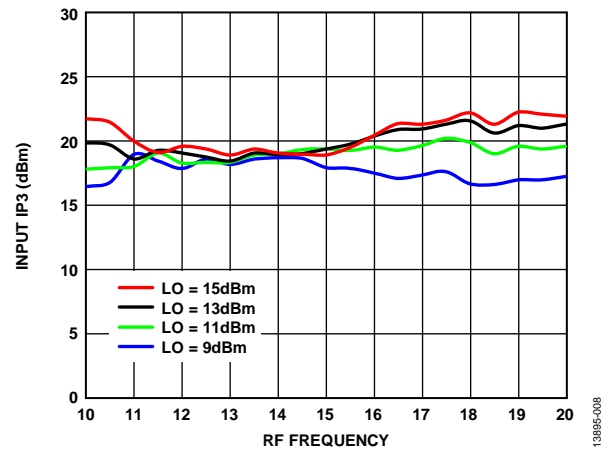

Figure 11. Input IP3 vs. RF Frequency at Various LO Power Levels, TA = 25°C

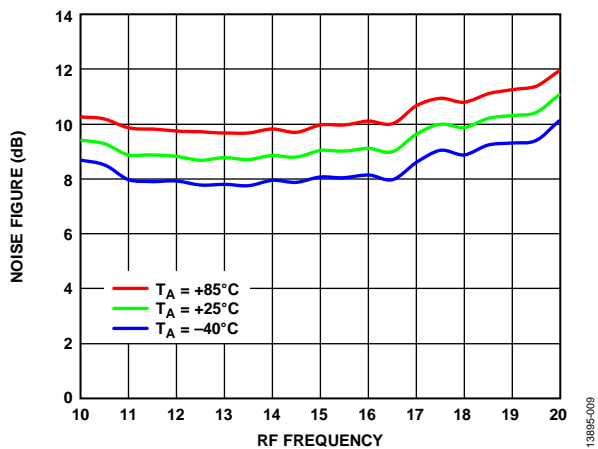

Figure 9. Noise Figure vs. RF Frequency at Various Temperatures, LO = 13 dBm

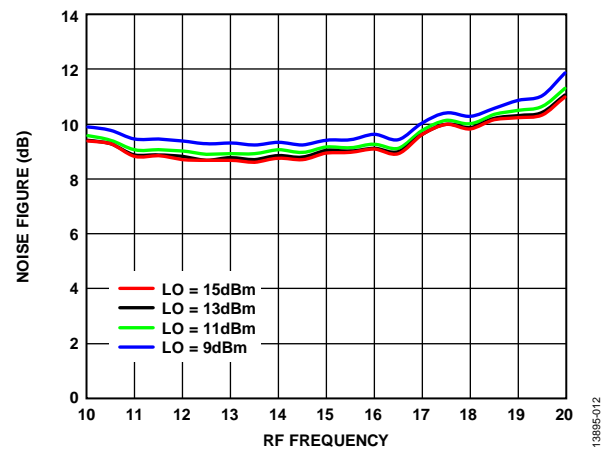

Figure 12. Noise Figure vs. RF Frequency at Various LO Power Levels, TA = 25°C

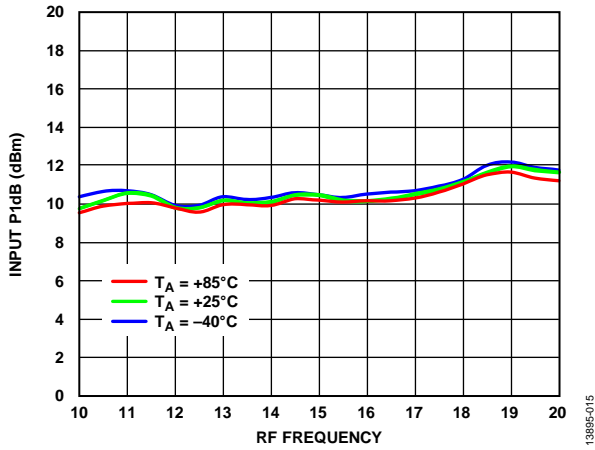

Figure 13. Input P1dB vs. RF Frequency at Various Temperatures, LO = 13 dBm

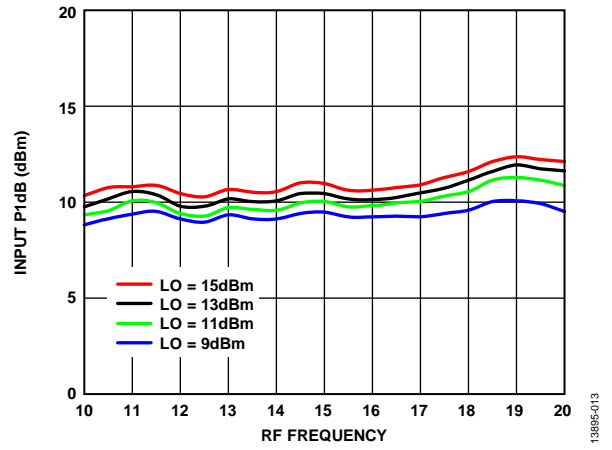

Figure 15. Input P1dB vs. RF Frequency at Various LO Power Levels, TA = 25°C

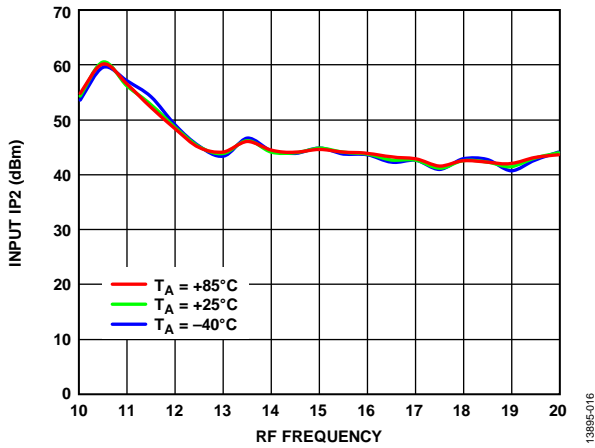

Figure 14. Input IP2 vs. RF Frequency at Various Temperatures, LO = 13 dBm

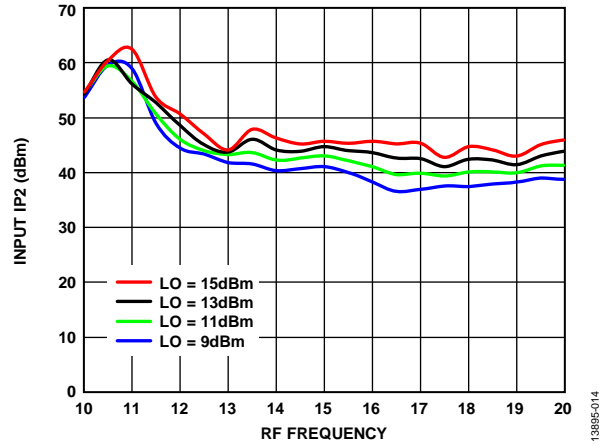

Figure 16. Input IP2 vs. RF Frequency at Various LO Power Levels, TA = 25°C

Lower Sideband (High-Side LO)

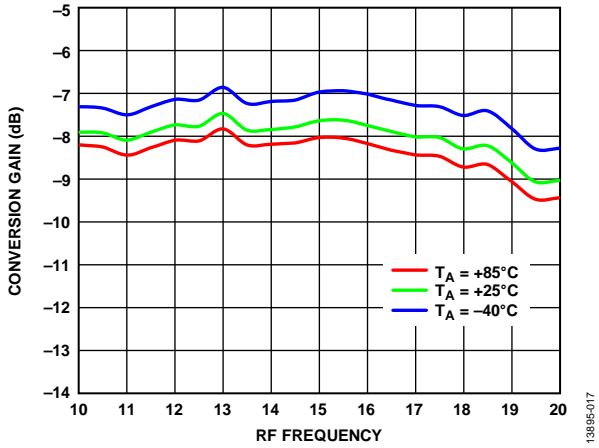

Figure 17. Conversion Gain vs. RF Frequency at Various Temperatures, LO = 13 dBm

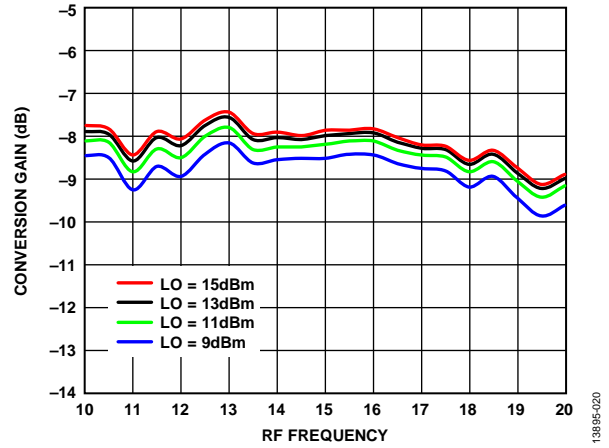

Figure 20. Conversion Gain vs. RF Frequency at Various LO Power Levels,  $T_A = 25^\circ\text{C}$

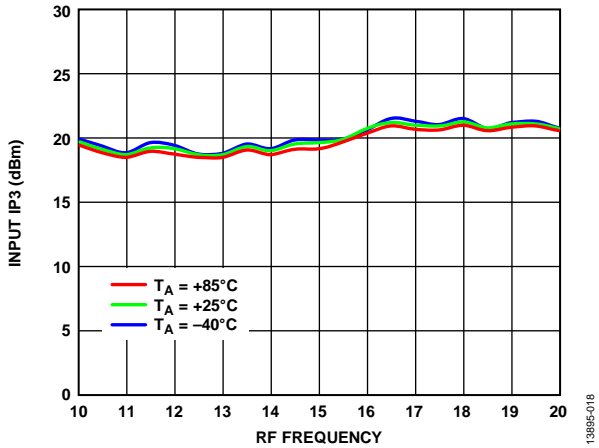

Figure 18. Input IP3 vs. RF Frequency at Various Temperatures, LO = 13 dBm

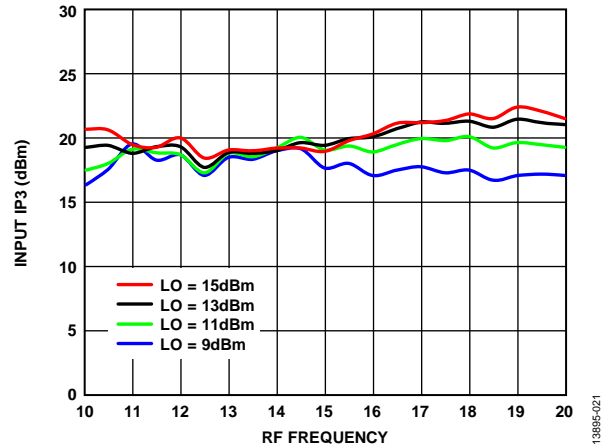

Figure 21. Input IP3 vs. RF Frequency at Various LO Power Levels,  $T_A = 25^\circ\text{C}$

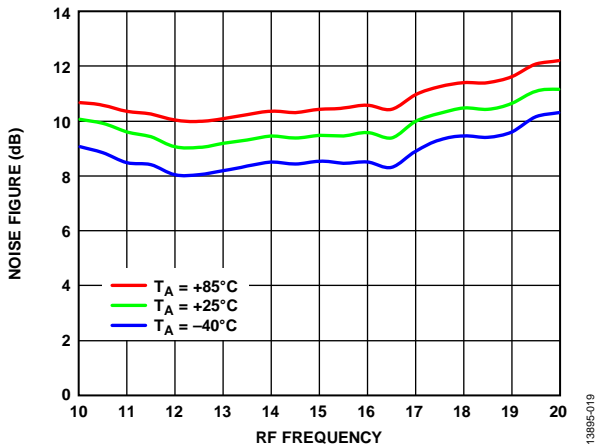

Figure 19. Noise Figure vs. RF Frequency at Various Temperatures, LO = 13 dBm

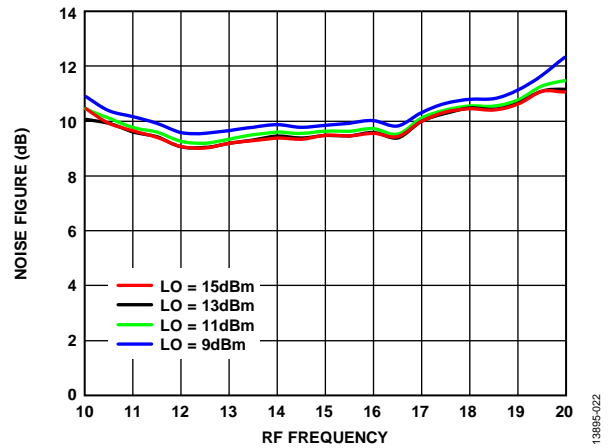

Figure 22. Noise Figure vs. RF Frequency at Various LO Power Levels,  $T_A = 25^\circ\text{C}$



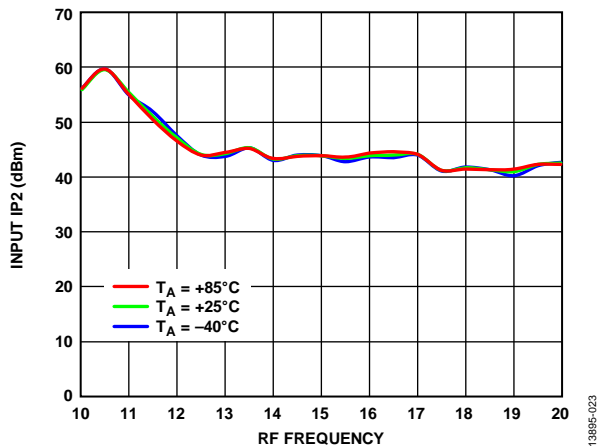

Figure 23. Input IP2 vs. RF Frequency at Various Temperatures, LO = 13 dBm

138895-023

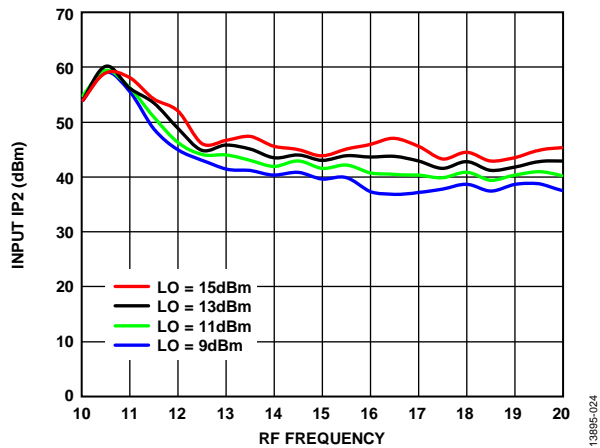

Figure 24. Input IP2 vs. RF Frequency at Various LO Power Levels, T<sub>A</sub> = 25°C

138895-024

**DOWNCONVERTER PERFORMANCE, IF = 3000 MHz**  
**Upper Sideband (Low-Side LO)**

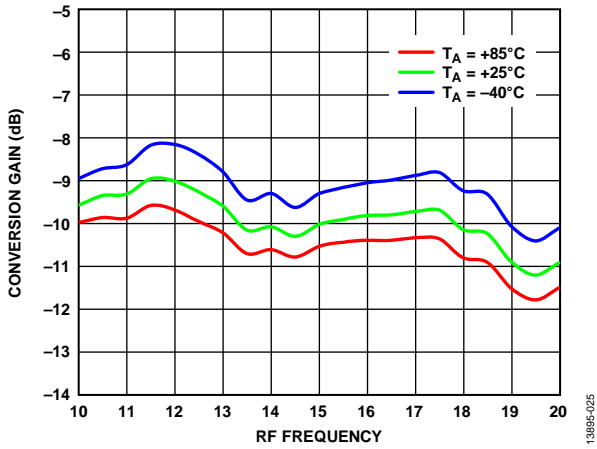

Figure 25. Conversion Gain vs. RF Frequency at Various Temperatures, LO = 13 dBm

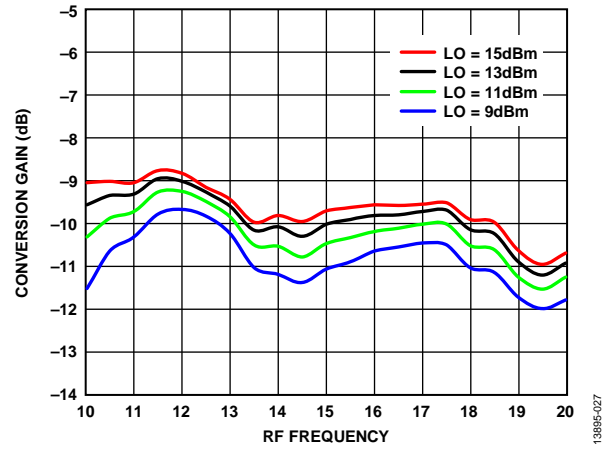

Figure 28. Conversion Gain vs. RF Frequency at Various LO Power Levels, TA = 25°C

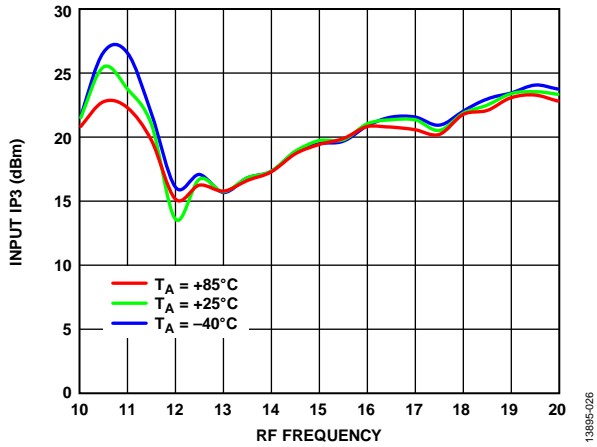

Figure 26. Input IP3 vs. RF Frequency at Various Temperatures, LO = 13 dBm

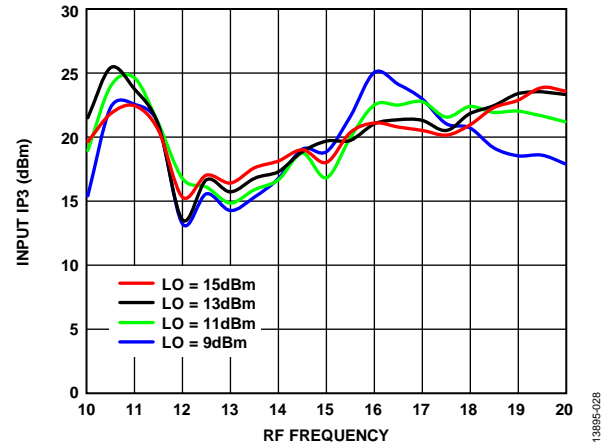

Figure 29. Input IP3 vs. RF Frequency at Various LO Power Levels, TA = 25°C

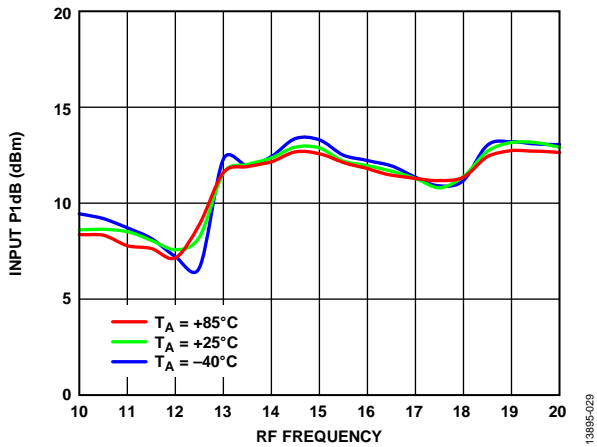

Figure 27. Input P1dB vs. RF Frequency at Various Temperatures, LO = 13 dBm

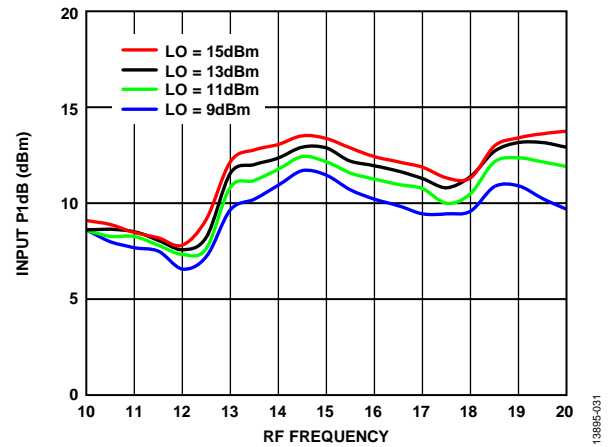

Figure 30. Input P1dB vs. RF Frequency at Various LO Power Levels, TA = 25°C

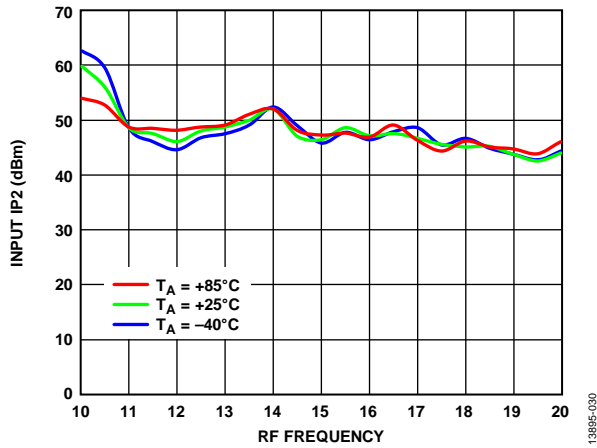

Figure 31. Input IP2 vs. RF Frequency at Various Temperatures, LO = 13 dBm

138895-000

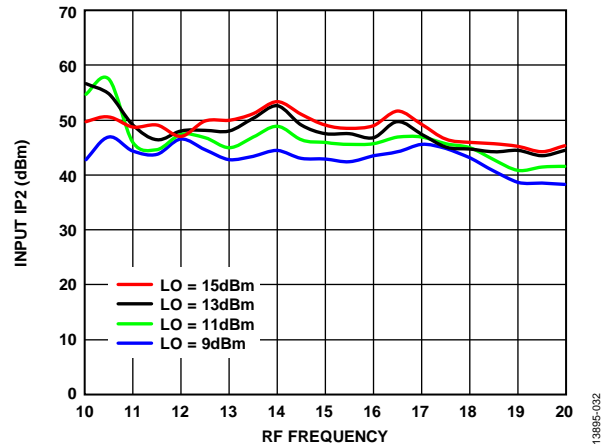

Figure 32. Input IP2 vs. RF Frequency at Various LO Power Levels, T<sub>A</sub> = 25°C

138895-002

Lower Sideband (High-Side LO)

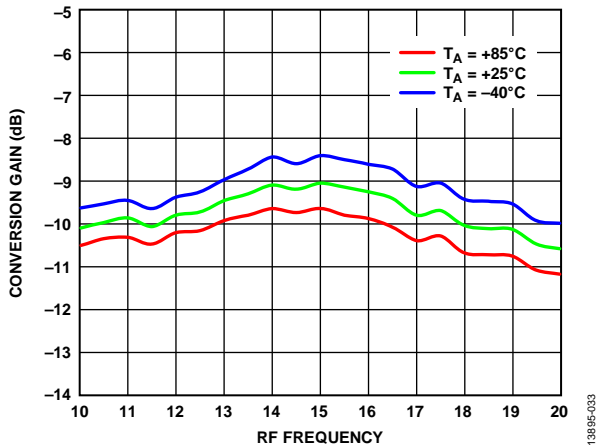

Figure 33. Conversion Gain vs. RF Frequency at Various Temperatures, LO = 13 dBm

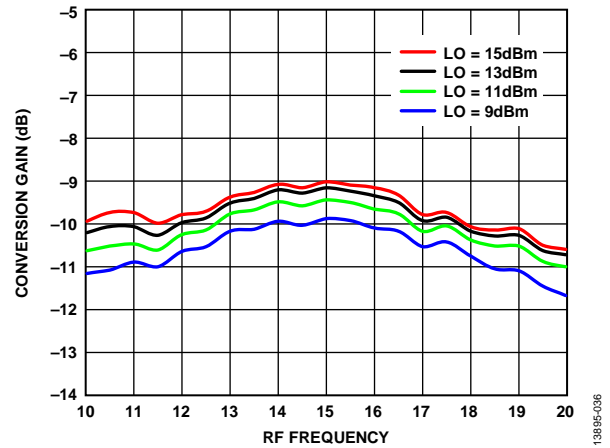

Figure 36. Conversion Gain vs. RF Frequency at Various LO Power Levels,  $T_A = 25^\circ\text{C}$

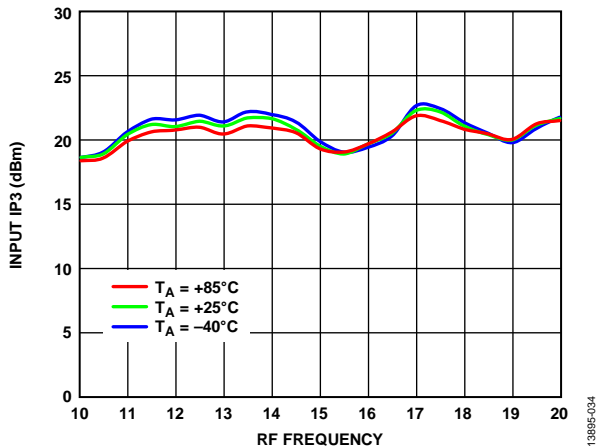

Figure 34. Input IP3 vs. RF Frequency at Various Temperatures, LO = 13 dBm

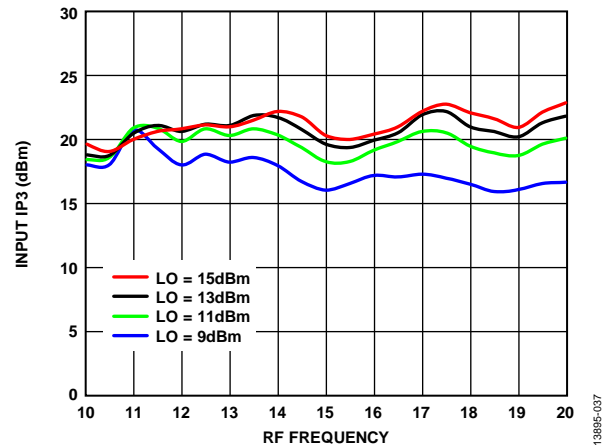

Figure 37. Input IP3 vs. RF Frequency at Various LO Power Levels,  $T_A = 25^\circ\text{C}$

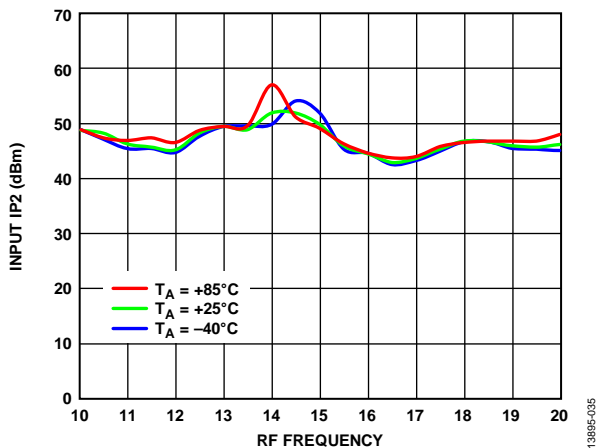

Figure 35. Input IP2 vs. RF Frequency at Various LO Power Levels,  $T_A = 25^\circ\text{C}$

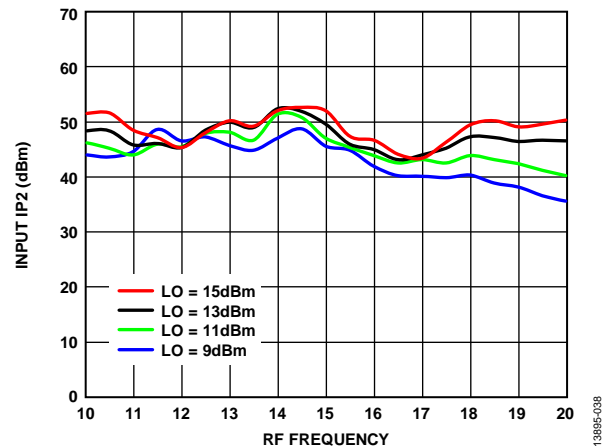

Figure 38. Input IP2 vs. RF Frequency at Various LO Power Levels,  $T_A = 25^\circ\text{C}$

UPCONVERTER PERFORMANCE,  $I_{F_{IN}} = 100 \text{ MHz}$

Upper Sideband (Low-Side LO)

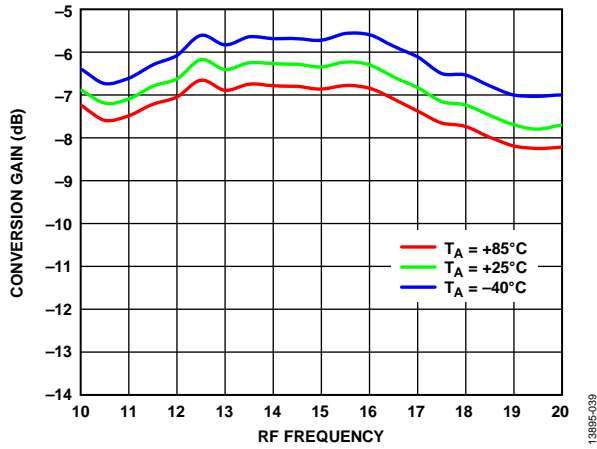

Figure 39. Conversion Gain vs. RF Frequency at Various Temperatures, LO = 13 dBm

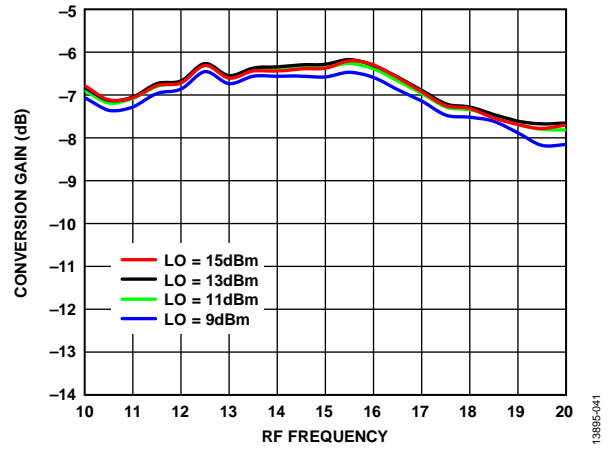

Figure 42. Conversion Gain vs. RF Frequency at Various LO Power Levels,  $T_A = 25^\circ\text{C}$

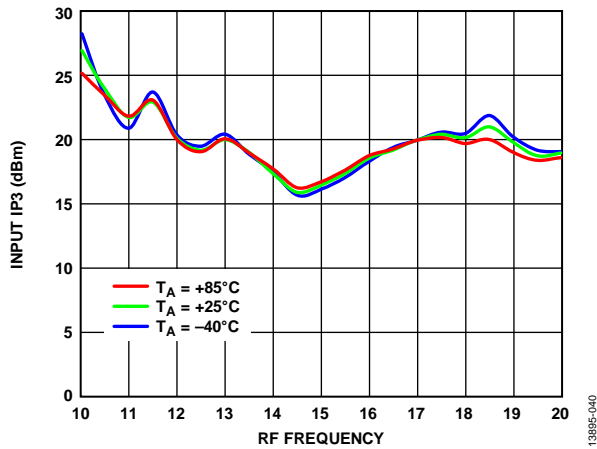

Figure 40. Input IP3 vs. RF Frequency at Various Temperatures, LO = 13 dBm

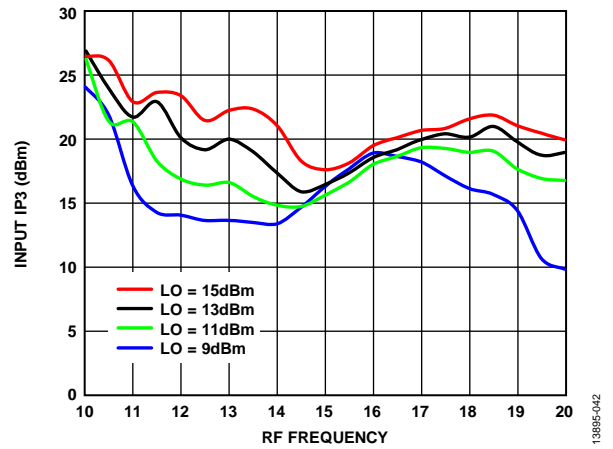

Figure 43. Input IP3 vs. RF Frequency at Various LO Power Levels,  $T_A = 25^\circ\text{C}$

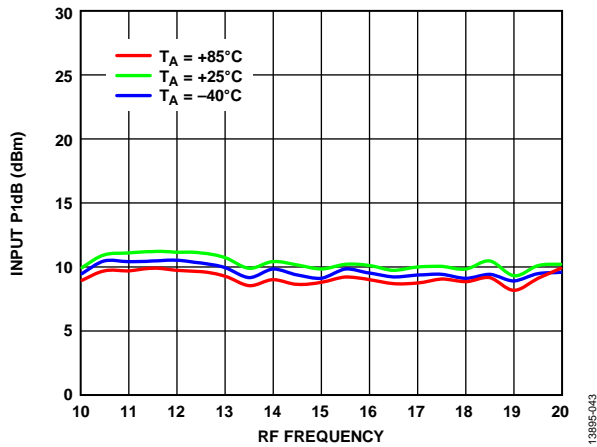

Figure 41. Input P1dB vs. RF Frequency at Various Temperatures, LO = 13 dBm

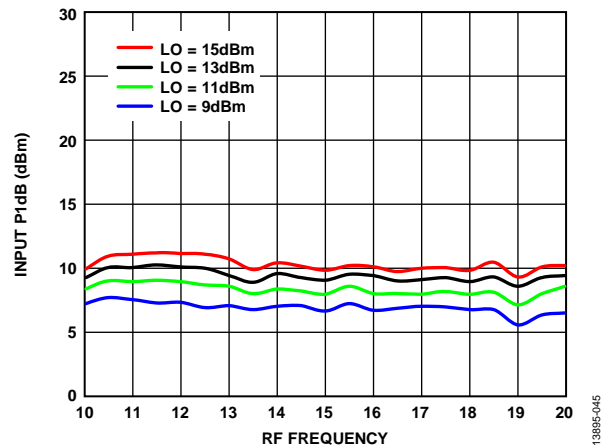

Figure 44. Input P1dB vs. RF Frequency at Various LO Power Levels,  $T_A = 25^\circ\text{C}$

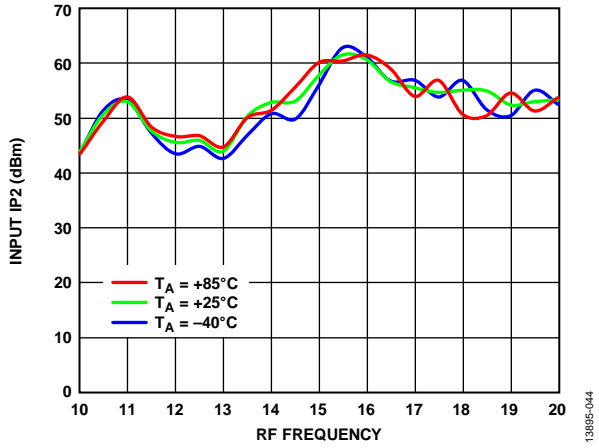

Figure 45. Input IP2 vs. RF Frequency at Various Temperatures, LO = 13 dBm

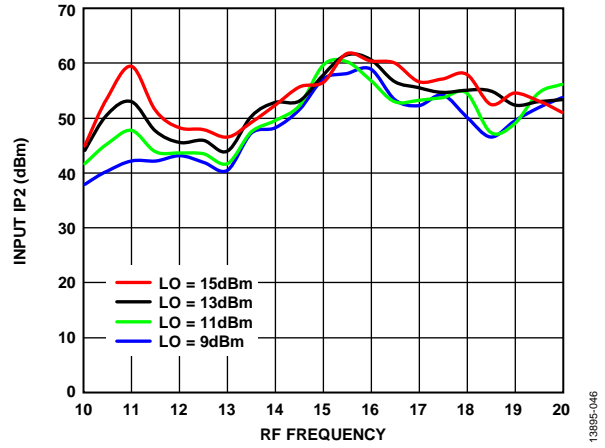

Figure 46. Input IP2 vs. RF Frequency at Various LO Power Levels, T<sub>A</sub> = 25°C

Lower Sideband (High-Side LO)

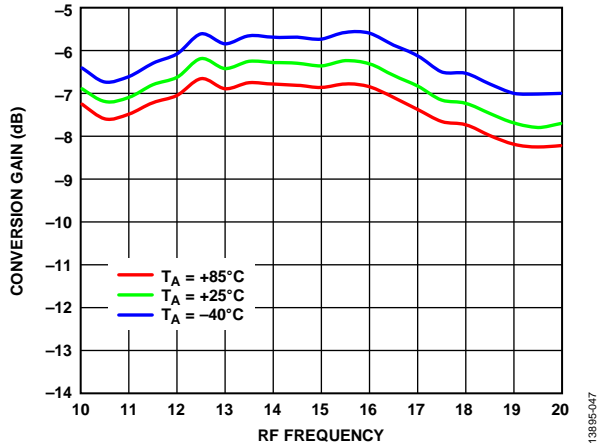

Figure 47. Conversion Gain vs. RF Frequency at Various Temperatures, LO = 13 dBm

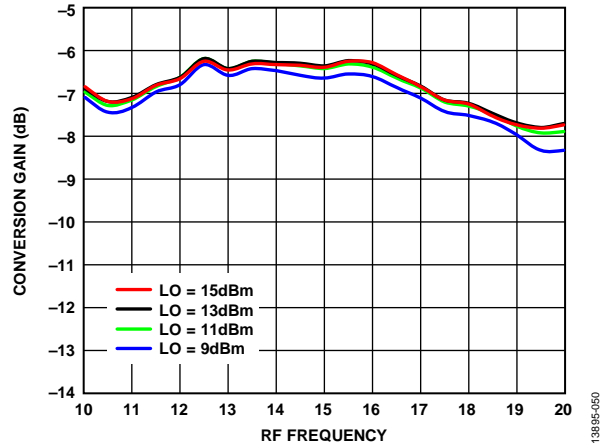

Figure 50. Conversion Gain vs. RF Frequency at Various LO Power Levels,  $T_A = 25^\circ\text{C}$

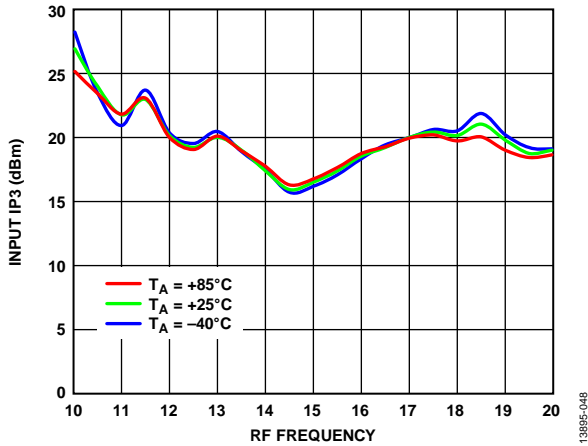

Figure 48. Input IP3 vs. RF Frequency at Various Temperatures, LO = 13 dBm

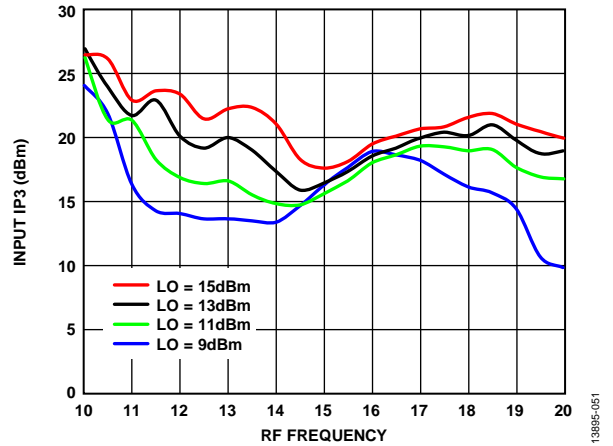

Figure 51. Input IP3 vs. RF Frequency at Various LO Power Levels,  $T_A = 25^\circ\text{C}$

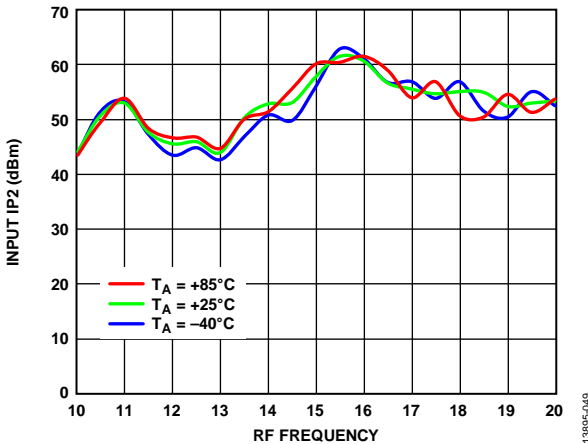

Figure 49. Input IP2 vs. RF Frequency at Various Temperatures, LO = 13 dBm

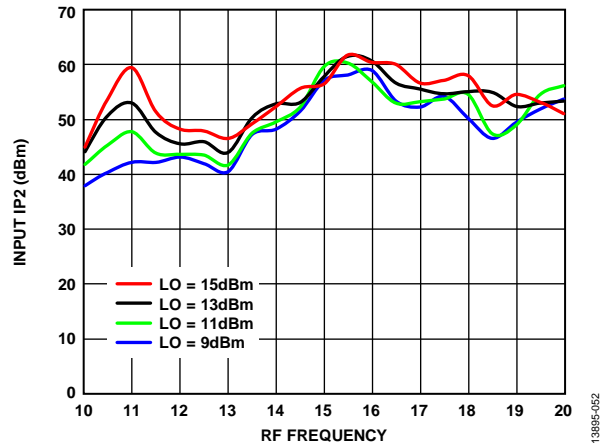

Figure 52. Input IP2 vs. RF Frequency at Various LO Power Levels,  $T_A = 25^\circ\text{C}$

**UPCONVERTER PERFORMANCE,  $I_{F_{IN}} = 3000$  MHz**  
**Upper Sideband (Low-Side LO)**

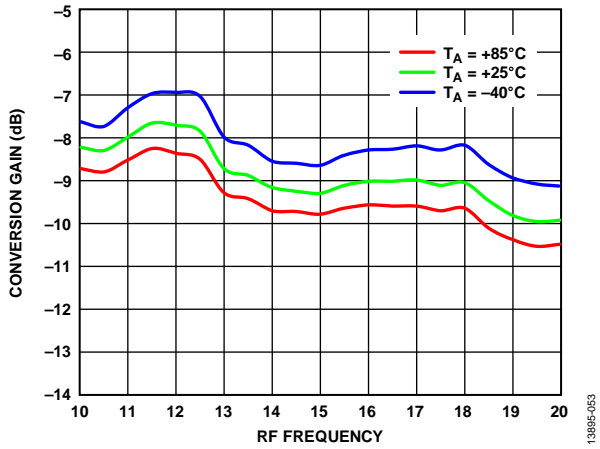

Figure 53. Conversion Gain vs. RF Frequency at Various Temperatures, LO = 13 dBm

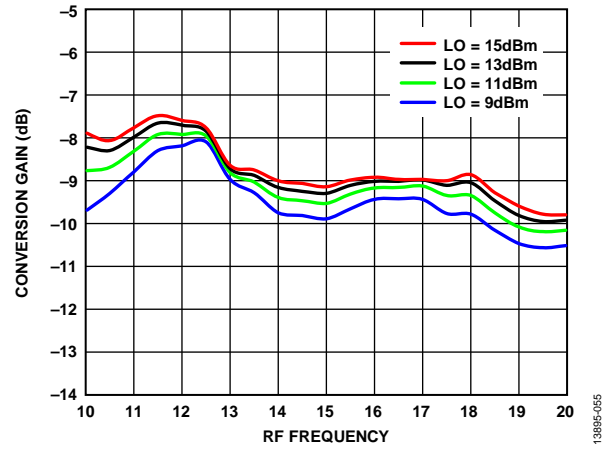

Figure 56. Conversion Gain vs. RF Frequency at Various LO Power Levels,  $T_A = 25^\circ\text{C}$

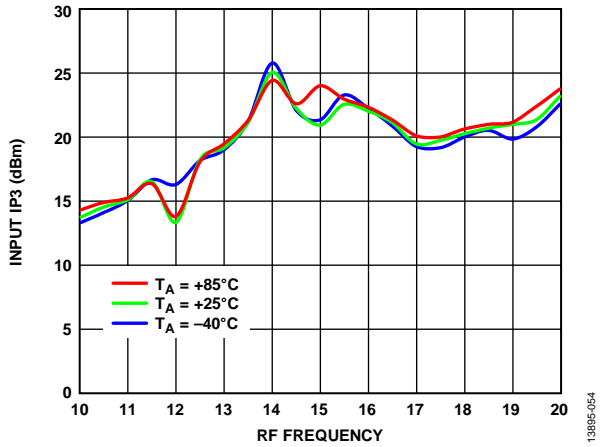

Figure 54. Input IP3 vs. RF Frequency at Various Temperatures, LO = 13 dBm

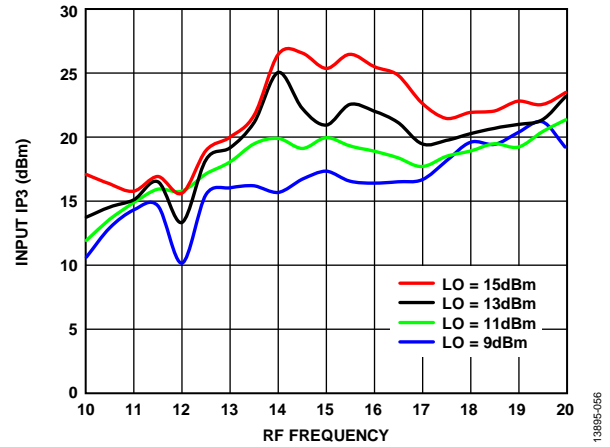

Figure 57. Input IP3 vs. RF Frequency at Various LO Power Levels,  $T_A = 25^\circ\text{C}$

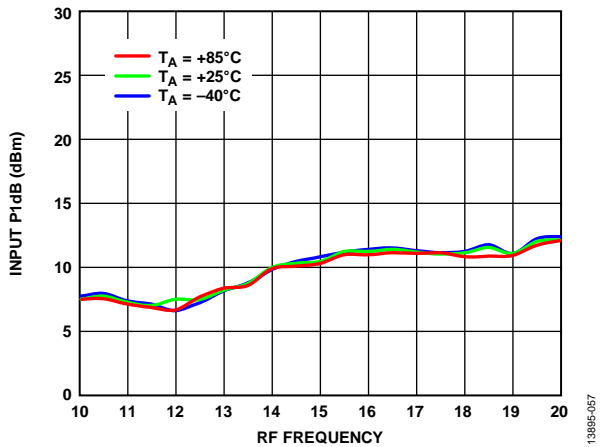

Figure 55. Input P1dB vs. RF Frequency at Various Temperatures, LO = 13 dBm

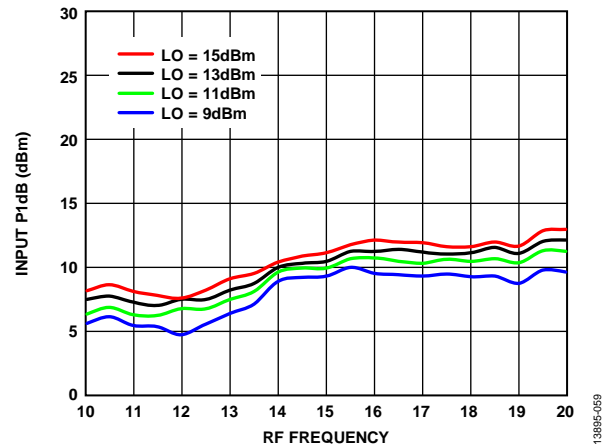

Figure 58. Input P1dB vs. RF Frequency at Various LO Power Levels,  $T_A = 25^\circ\text{C}$



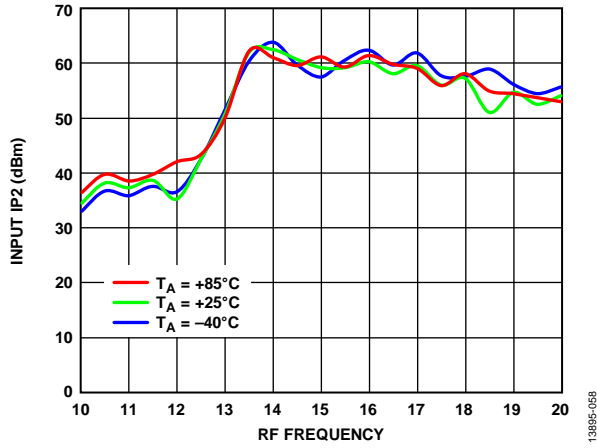

Figure 59. Input IP2 vs. RF Frequency at Various Temperatures, LO = 13 dBm

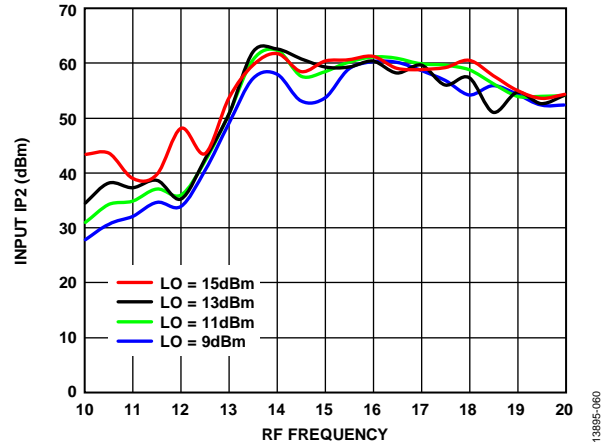

Figure 60. Input IP2 vs. RF Frequency at Various LO Power Levels, TA = 25°C

Lower Sideband (High-Side LO)

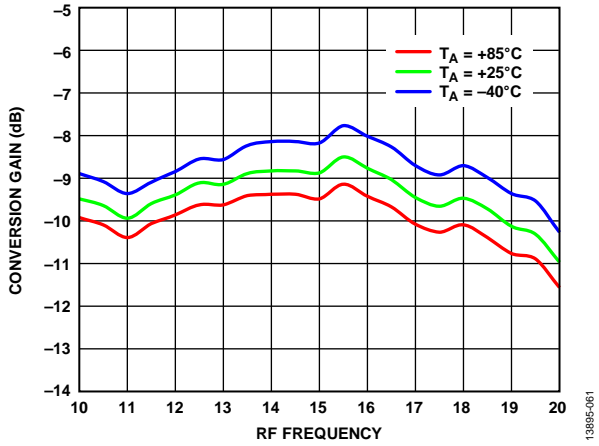

Figure 61. Conversion Gain vs. RF Frequency at Various Temperatures, LO = 13 dBm

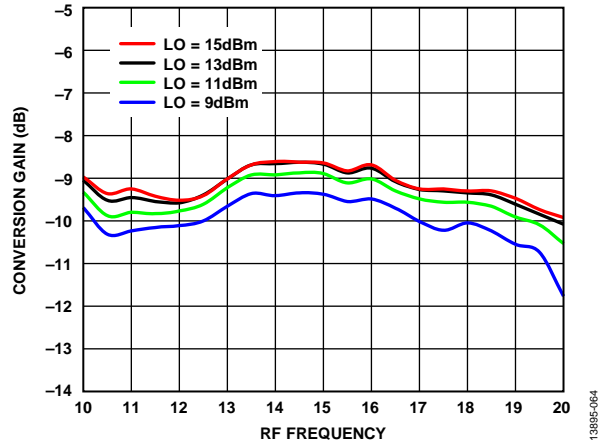

Figure 64. Conversion Gain vs. RF Frequency at Various LO Power Levels,  $T_A = 25^\circ\text{C}$

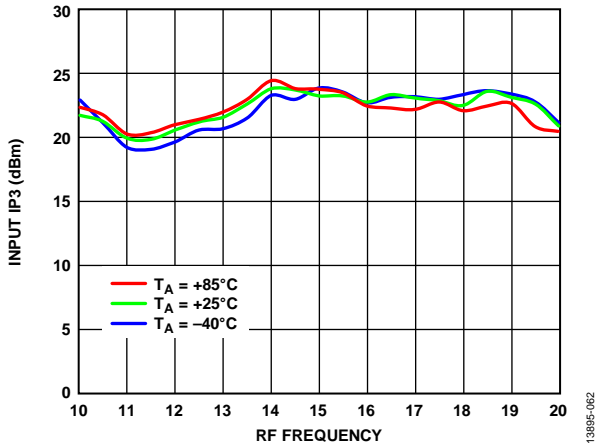

Figure 62. Input IP3 vs. RF Frequency at Various Temperatures, LO = 13 dBm

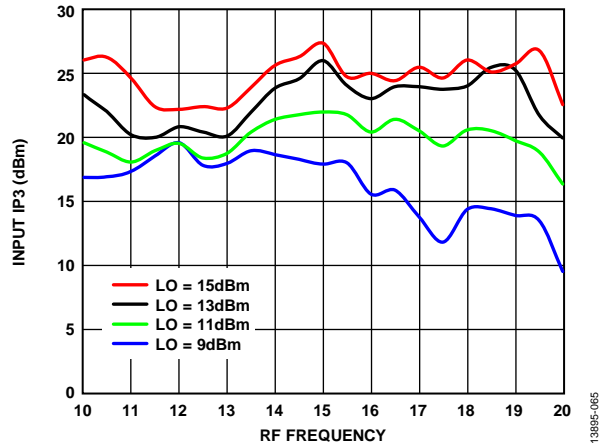

Figure 65. Input IP3 vs. RF Frequency at Various LO Power Levels,  $T_A = 25^\circ\text{C}$

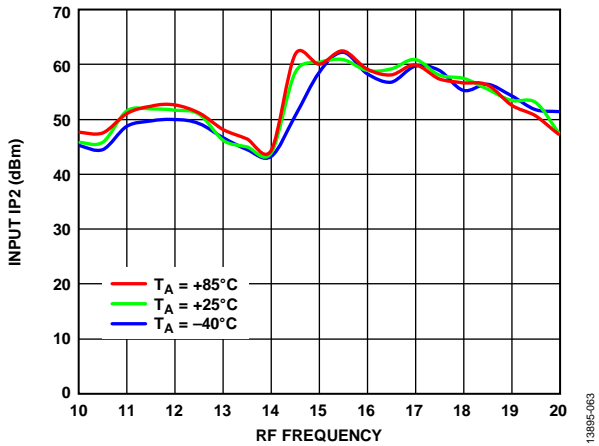

Figure 63. Input IP2 vs. RF Frequency at Various Temperatures, LO = 13 dBm

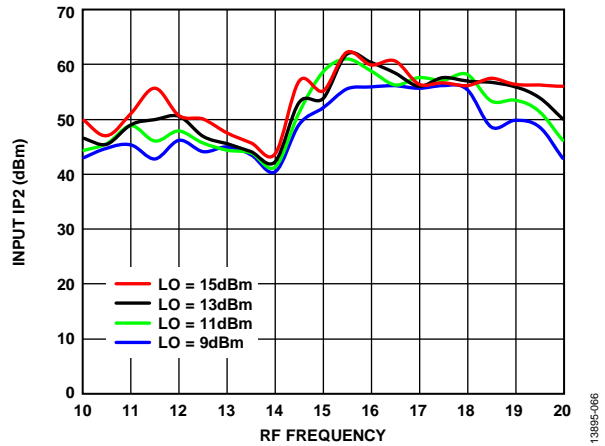

Figure 66. Input IP2 vs. RF Frequency at Various LO Power Levels,  $T_A = 25^\circ\text{C}$

ISOLATION AND RETURN LOSS

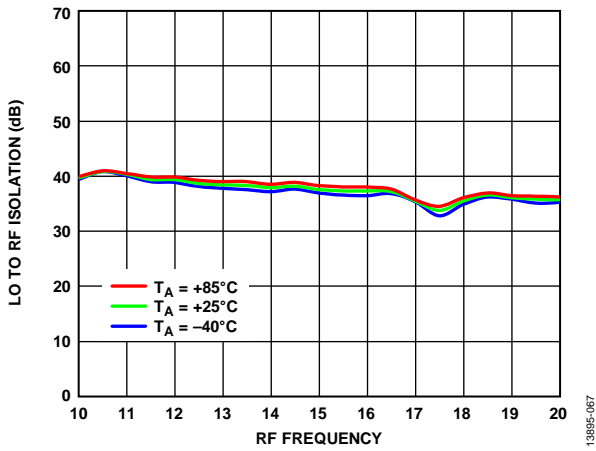

Figure 67. LO to RF Isolation vs. RF Frequency at Various Temperatures, LO = 13 dBm

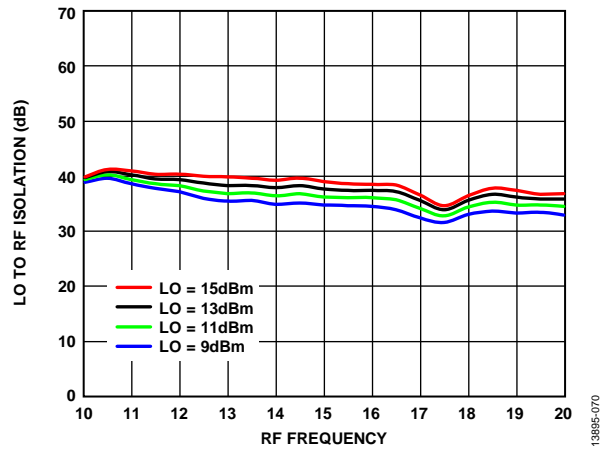

Figure 70. LO to RF Isolation vs. RF Frequency at Various LO Power Levels, TA = 25°C

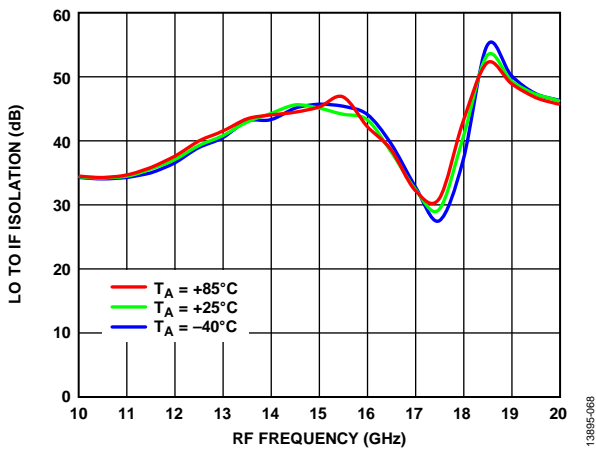

Figure 68. LO to IF Isolation vs. RF Frequency at Various Temperatures, LO = 13 dBm

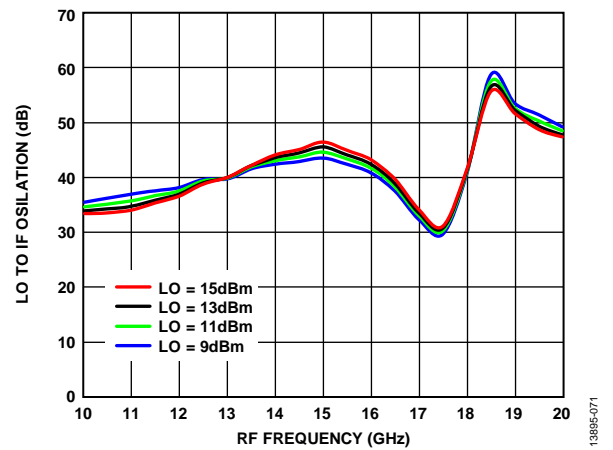

Figure 71. LO to IF Isolation vs. RF Frequency at Various LO Power Levels, TA = 25°C

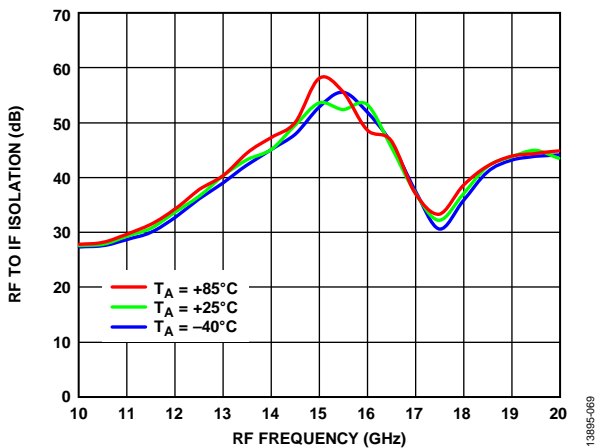

Figure 69. RF to IF Isolation vs. RF Frequency at Various Temperatures, LO = 13 dBm

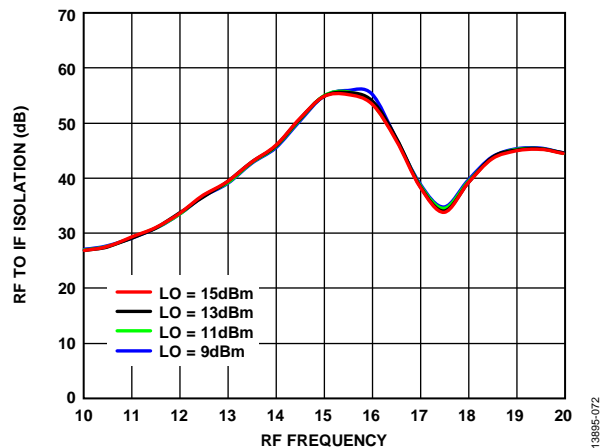

Figure 72. RF to IF Isolation vs. RF Frequency at Various LO Power Levels, TA = 25°C

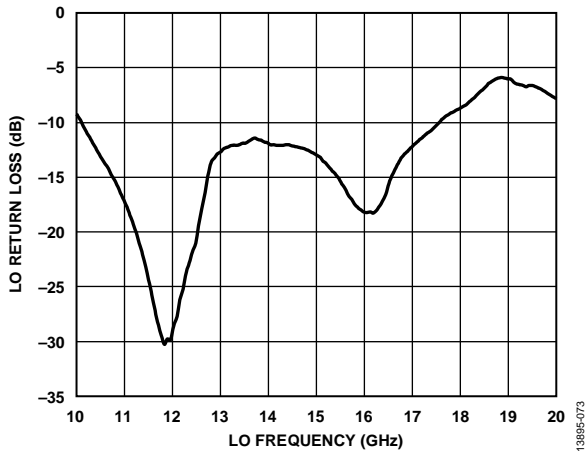

Figure 73. LO Return Loss vs. LO Frequency at LO = 13 dBm,  $T_A = 25^\circ\text{C}$

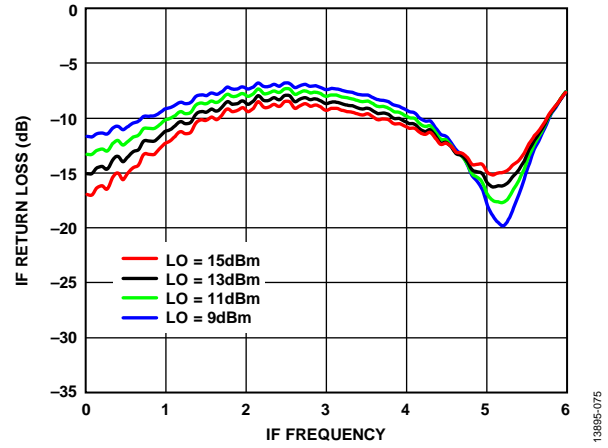

Figure 75. IF Return Loss vs. IF Frequency at LO Power Levels,  $T_A = 25^\circ\text{C}$ , LO = 15 GHz

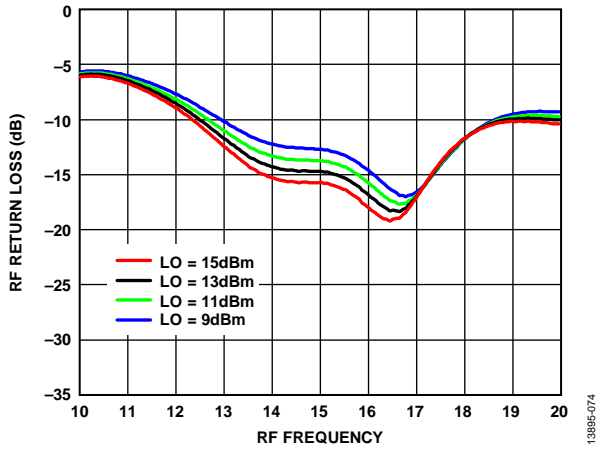

Figure 74. RF Return Loss vs. RF Frequency at LO Power Levels,  $T_A = 25^\circ\text{C}$ , LO = 15 GHz

13895-073

13895-075

13895-074

**IF BANDWIDTH—DOWNCONVERTER**

*Upper Sideband, LO Frequency = 12 GHz*

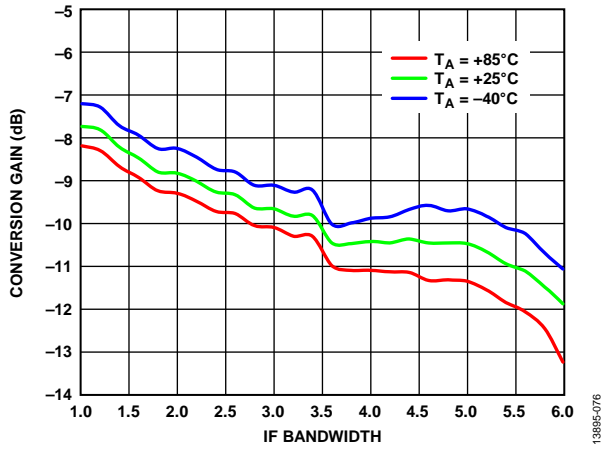

Figure 76. Conversion Gain vs. IF Frequency at Various Temperatures, LO = 13 dBm

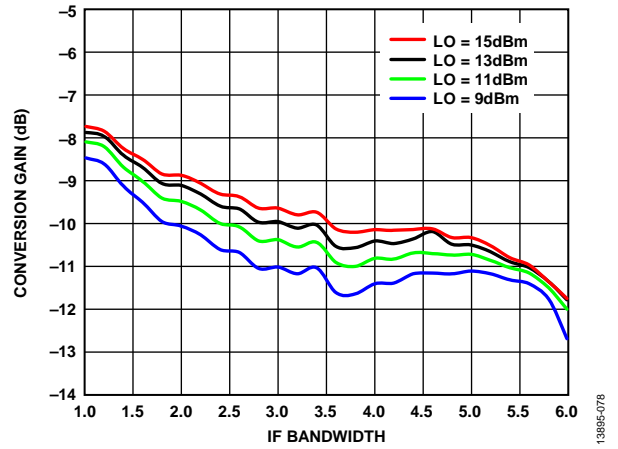

Figure 78. Conversion Gain vs. IF Frequency at Various LO Power Levels,  $T_A = 25^\circ\text{C}$

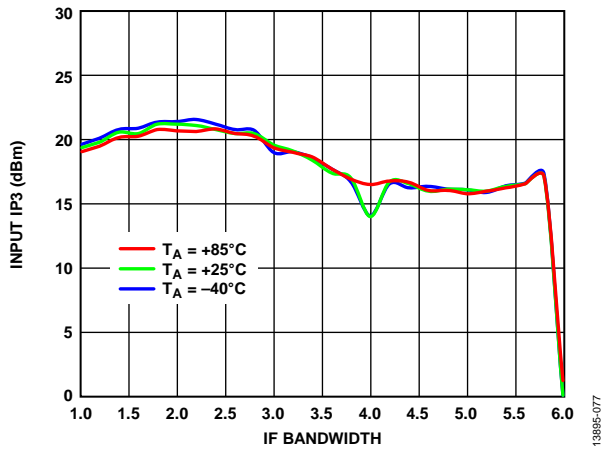

Figure 77. Input IP3 vs. IF Frequency at Various Temperatures, LO = 13 dBm

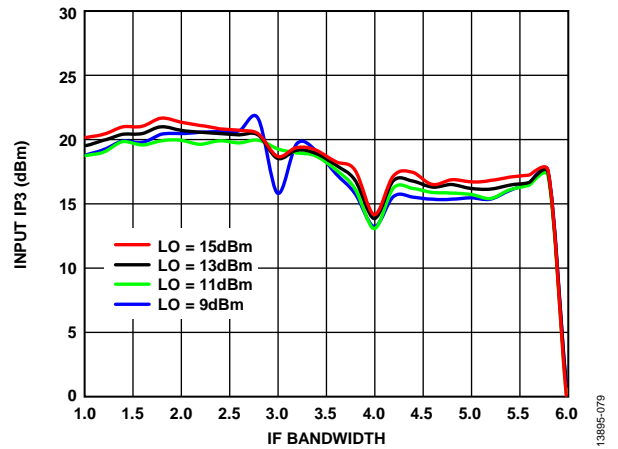

Figure 79. Input IP3 vs. IF Frequency at Various LO Power Levels,  $T_A = 25^\circ\text{C}$

Lower Sideband, LO Frequency = 19 GHz

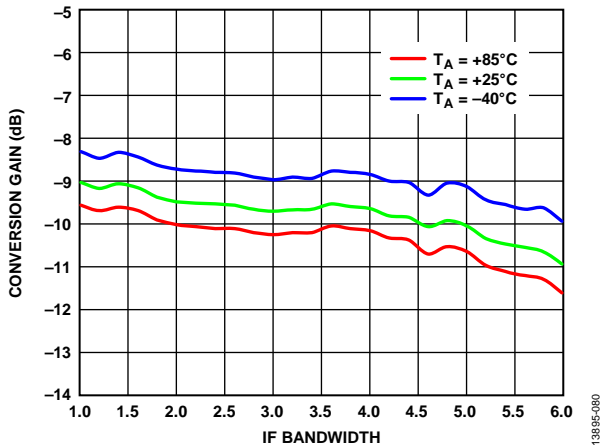

Figure 80. Conversion Gain vs. IF Frequency at Various Temperatures, LO = 13 dBm

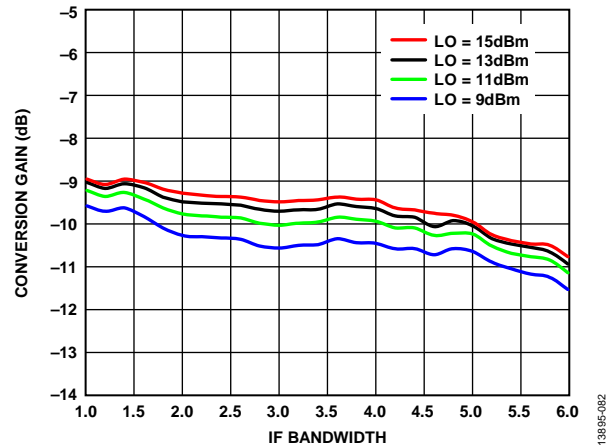

Figure 82. Conversion Gain vs. IF Frequency at Various LO Power Levels,  $T_A = 25^\circ\text{C}$

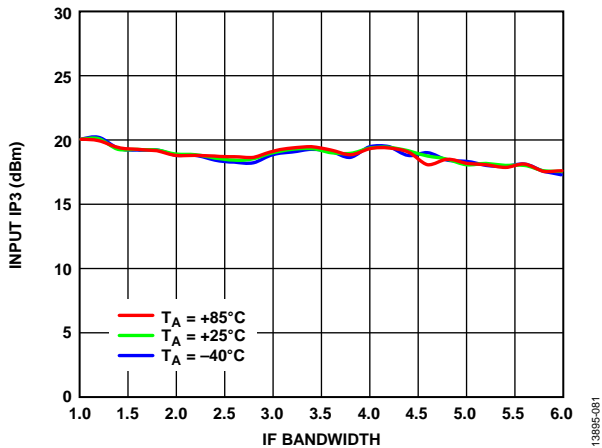

Figure 81. Input IP3 vs. IF Frequency at Various Temperatures, LO = 13 dBm

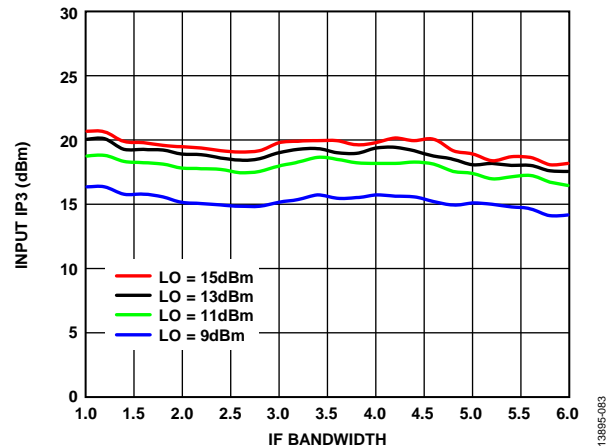

Figure 83. Input IP3 vs. IF Frequency at Various LO Power Levels,  $T_A = 25^\circ\text{C}$

**SPURIOUS AND HARMONICS PERFORMANCE**

Mixer spurious products are measured in dBc from the IF output power level. N/A means not applicable.

**LO Harmonics**

LO = 13 dBm, all values in dBc below input LO level and measured at RF port.

**Table 5. LO Harmonics at RF**

LO Frequency (GHz)	N × LO Spur at RF Port			
	1	2	3	4
12	39	39	59	57
13	38	40	70	N/A
15	38	48	49	N/A
16	37	56	50	N/A
18	36	54	N/A	N/A
19	36	53	N/A	N/A
21	36	46	N/A	N/A

LO = 13 dBm, all values in dBc below input LO level and measured at IF port.

**Table 6. LO Harmonics at IF**

LO Frequency (GHz)	N × LO Spur at IF Port			
	1	2	3	4
12	38	77	67	89
13	41	63	74	N/A
15	44	72	56	N/A
16	42	53	56	N/A
18	44	79	N/A	N/A
19	53	70	N/A	N/A
21	47	75	N/A	N/A

**M × N Spurious Outputs**

**Downconverter, Upper Sideband**

Spur values are (M × RF) – (N × LO).

RF = 15.1 GHz at –10 dBm, LO = 15 GHz at 13 dBm.

		N × LO					
		0	1	2	3	4	5
M × RF	0	N/A	14	47	27	N/A	N/A
	1	48	0	70	72	65	N/A
	2	75	77	60	79	74	68
	3	65	74	79	70	78	71
	4	N/A	60	74	80	88	78
	5	N/A	N/A	56	72	81	88

**Upconverter, Upper Sideband**

Spur values are (M × IF) + (N × LO).

IF<sub>IN</sub> = 100 MHz at –10 dBm, LO = 15 GHz at 13 dBm.

		N × LO			
		0	1	2	3
M × IF	–5	89	80	73	67
	–4	88	79	73	68
	–3	91	66	74	66
	–2	91	67	74	66
	–1	36	0	35	20
	0	N/A	6	17	22
	+1	36	0	35	19
	+2	88	63	73	65
	+3	90	63	74	66
	+4	90	80	73	65
	+5	88	78	72	66

## **THEORY OF OPERATION**

The HMC554ALC3B is a general-purpose, double balanced mixer that can be used as an upconverter or a downconverter from 10 GHz to 20 GHz.

When used as a downconverter, the HMC554ALC3B downconverts RF between 10 GHz and 20 GHz to IF between dc and 6 GHz.

When used as an upconverter, the mixer upconverts intermediate frequencies between dc and 6 GHz to radio frequencies between 10 GHz and 20 GHz.



## APPLICATIONS INFORMATION

### TYPICAL APPLICATION CIRCUIT

Figure 84 shows the typical application circuit for the HMC554ALC3B. The HMC554ALC3B is a passive device and does not require any external components. The IF pin is internally dc-coupled. The RF and LO pins are internally ac-coupled. When IF operation to dc is not required, using an external series capacitor is recommended, of a value chosen to pass the necessary IF frequency range. When IF operation to dc is required, do not exceed the IF source and sink current rating specified in the Absolute Maximum Ratings section.

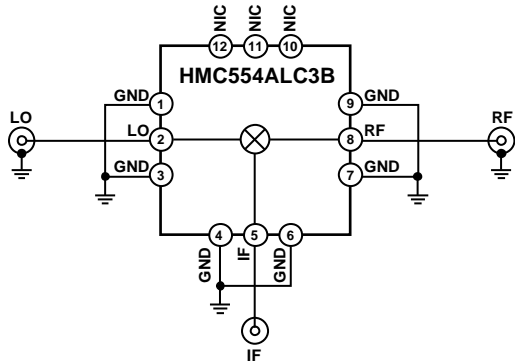

Figure 84. Typical Application Circuit

### EVALUATION PCB INFORMATION

Use RF circuit design techniques for the circuit board used in the application. Ensure that signal lines have 50 Ω impedance and connect the package ground leads and the exposed pad directly to the ground plane (see Figure 84). Use a sufficient number of via holes to connect the top and bottom ground planes. The evaluation circuit board shown in Figure 85 is available from Analog Devices, Inc., upon request.

Table 7. List of Materials for Evaluation PCB  
EV1HMC554ALC3B

Item	Description
J1, J2	PCB mount SRI 2.92 mm connectors
J3	PCB mount Johnson SMA connector
U1	HMC554ALC3B
PCB <sup>1</sup>	117611-1 evaluation board on Rogers 4350

<sup>1</sup> 117611-1 is the raw bare PCB identifier. Reference EV1HMC554ALC3B when ordering complete evaluation PCB.

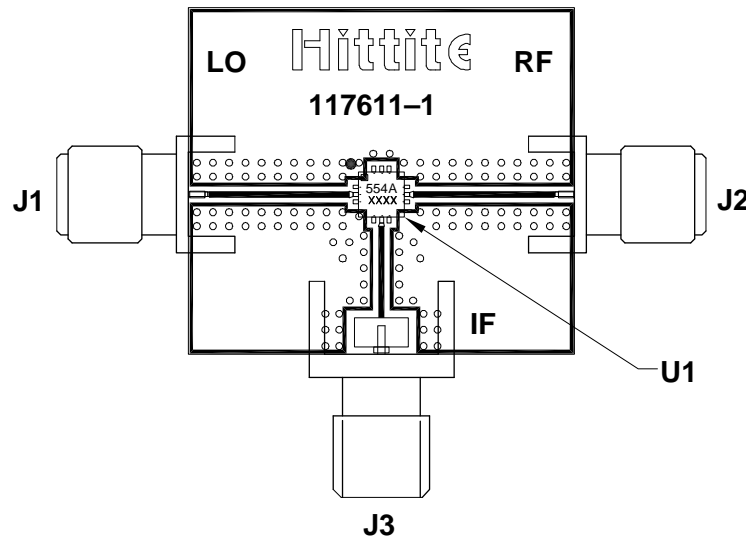

Figure 85. Evaluation PCB Top Layer