

## FEATURES

**Passive: no dc bias required**  
**Conversion loss: 7 dB typical at 6 GHz to 11 GHz**  
**Input IP3: 18 dBm typical at 6 GHz to 11 GHz**  
**LO to RF isolation: 36 dB typical**  
**Wide IF bandwidth: dc to 5 GHz**  
**RoHS compliant, 12-terminal, 2.90 mm × 2.90 mm LCC package**

## APPLICATIONS

**Microwave and very small aperture terminal (VSAT) radios**  
**Test equipment**  
**Point to point radios**  
**Military electronic warfare (EW); electronic countermeasure (ECM); and command, control, communications and intelligence (C3I)**

## GENERAL DESCRIPTION

The HMC553ALC3B is a general-purpose, double-balanced, gallium arsenide (GaAs), monolithic microwave integrated circuit (MMIC) mixer housed in a leadless Pb-free, RoHS compliant LCC package. The HMC553ALC3B can be used as an upconverter or downconverter between 6 GHz and 14 GHz. This mixer requires no external components or matching circuitry.

## FUNCTIONAL BLOCK DIAGRAM

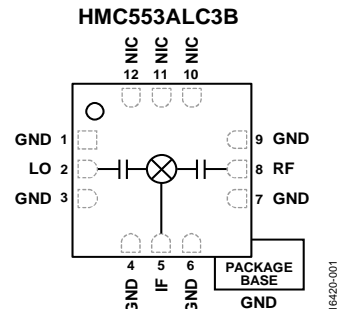

Figure 1.

The HMC553ALC3B provides local oscillator (LO) to radio frequency (RF) and LO to intermediate frequency (IF) suppression due to optimized balun structures. The mixer operates with LO drive levels from 9 dBm to 15 dBm. The HMC553ALC3B eliminates the need for wire bonding, allowing use of surface-mount manufacturing techniques.

**TABLE OF CONTENTS**

Features .....	1	Upconverter Performance.....	14
Applications.....	1	Isolation and Return Loss .....	18
Functional Block Diagram .....	1	IF Bandwidth—Downconverter, Upper Sideband.....	20
General Description .....	1	IF Bandwidth—Downconverter, Lower Sideband.....	21
Revision History .....	2	Spurious and Harmonics Performance .....	22
Specifications.....	3	Theory of Operation .....	23
Absolute Maximum Ratings.....	4	Applications Information .....	24
Thermal Resistance .....	4	Typical Application Circuit.....	24
ESD Caution.....	4	Evaluation PCB Information .....	24
Pin Configuration and Function Descriptions.....	5	Outline Dimensions .....	25
Interface Schematics.....	5	Ordering Guide .....	25
Typical Performance Characteristics .....	6		
Downconverter Performance.....	6		

**REVISION HISTORY**

**3/2019—Rev.A to Rev. B**

Change to Table 5 .....	22
Changes to Downconversion, Upper Sideband Section, Downconversion, Lower Sideband Section, Upconversion, Upper Sideband Section, and Upconversion, Lower Sideband Section ...	22

**6/2018—Rev.0 to Rev. A**

Added 6 GHz to 11 GHz Downconverter Performance, Noise Figure Parameter and 11 GHz to 14 GHz Downconverter Performance, Noise Figure Parameter, Table 1 .....	3
---	---

**2/2018—Revision 0: Initial Version**

## SPECIFICATIONS

$T_A = 25^\circ\text{C}$ , IF = 100 MHz, RF = -10 dBm, LO = 13 dBm, upper side band. All measurements performed as a downconverter, unless otherwise noted, on the evaluation printed circuit board (PCB).

Table 1.

Parameter	Symbol	Test Conditions/Comments	Min	Typ	Max	Unit
FREQUENCY RANGE						
RF			6		14	GHz
LO Input			6		14	GHz
IF			DC		5	GHz
LO DRIVE LEVELS						
			9	13	15	dBm
6 GHz to 11 GHz PERFORMANCE						
Downconverter						
Conversion Loss				7	9	dB
Noise Figure				8.5		dB
Input Third-Order Intercept	IP3		15	18		dBm
Input 1 dB Compression Point	P1dB			9.5		dBm
Input Second-Order Intercept	IP2			40		dBm
Upconverter						
Conversion Loss	IF <sub>IN</sub>			7		dB
Input Third-Order Intercept	IP3			19		dBm
Input 1 dB Compression Point	P1dB			8		dBm
Isolation						
RF to IF			18	32		dB
LO to RF			30	36		dB
LO to IF			28	32		dB
11 GHz to 14 GHz PERFORMANCE						
Downconverter						
Conversion Loss				9	10	dB
Noise Figure				10		dB
Input Third-Order Intercept	IP3		18	22		dBm
Input 1 dB Compression Point	P1dB			11.5		dBm
Input Second-Order Intercept	IP2			45		dBm
Upconverter						
Conversion Loss	IF <sub>IN</sub>			8		dB
Input Third-Order Intercept	IP3			19		dBm
Input 1 dB Compression Point	P1dB			8		dBm
Isolation						
RF to IF			25	29		dB
LO to RF			30	37		dB
LO to IF			28	33		dB

## ABSOLUTE MAXIMUM RATINGS

Table 2.

Parameter	Rating
RF Input Power	25 dBm
LO Input Power	25 dBm
IF Input Power	25 dBm
IF Source/Sink Current	3 mA
Reflow Temperature	260°C
Maximum Junction Temperature	175°C
Continuous Power Dissipation, $P_{DISS}$ ( $T_A = 85^\circ\text{C}$ , Derate 4.6 mW/°C Above 85°C)	414 mW
Operating Temperature Range	-40°C to +85°C
Storage Temperature Range	-65°C to +150°C
Lead Temperature Range	-65°C to +150°C
Electrostatic Discharge (ESD) Sensitivity	
Human Body Model (HBM)	1000 V
Field Induced Charged Device Model (FICDM)	1250 V

Stresses at or above those listed under Absolute Maximum Ratings may cause permanent damage to the product. This is a stress rating only; functional operation of the product at these or any other conditions above those indicated in the operational section of this specification is not implied. Operation beyond the maximum operating conditions for extended periods may affect product reliability.

## THERMAL RESISTANCE

Thermal performance is directly linked to PCB design and operating environment. Careful attention to PCB thermal design is required.

$\theta_{JA}$  is the natural convection junction to ambient thermal resistance measured in a one cubic foot sealed enclosure.  $\theta_{JC}$  is the junction to case thermal resistance.

Table 3. Thermal Resistance

Package Type	$\theta_{JA}$	$\theta_{JC}$	Unit
E-12-4 <sup>1</sup>	120	175	°C/W

<sup>1</sup> See JEDEC standard JESD51-2 for additional information on optimizing the thermal impedance (PCB with 3 × 3 vias).

## ESD CAUTION



**ESD (electrostatic discharge) sensitive device.** Charged devices and circuit boards can discharge without detection. Although this product features patented or proprietary protection circuitry, damage may occur on devices subjected to high energy ESD. Therefore, proper ESD precautions should be taken to avoid performance degradation or loss of functionality.

# PIN CONFIGURATION AND FUNCTION DESCRIPTIONS

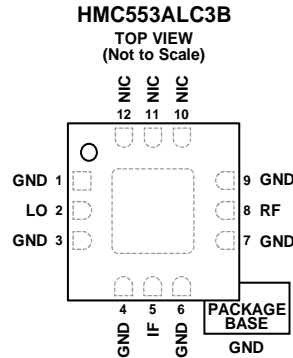

- NOTES**
1. NOT INTERNALLY CONNECTED. THESE PINS CAN BE CONNECTED TO RF/DC GROUND. PERFORMANCE IS NOT AFFECTED.
  2. EXPOSED PAD. THE EXPOSED PAD MUST BE CONNECTED TO RF/DC GROUND.

16420-002

Figure 2. Pin Configuration

Table 4. Pin Function Descriptions

Pin No.	Mnemonic	Description
1, 3, 4, 6, 7, 9	GND	Ground. These pins and package bottom must be connected to RF/dc ground.
2	LO	Local Oscillator Port. This pin is ac-coupled and matched to 50 Ω.
5	IF	Intermediate Frequency Port. This pin is dc-coupled. For applications not requiring operation to dc, dc block this port externally using a series capacitor of a value chosen to pass the necessary IF frequency range. For operation to dc, this pin must not source or sink more than 3 mA of current or die malfunction and possible die failure may result.
8	RF	Radio Frequency Port. This pin is ac-coupled and matched to 50 Ω.
10, 11, 12	NIC EPAD	Not Internally Connected. These pins can be connected to RF/dc ground. Performance is not affected. Exposed Pad. The exposed pad must be connected to RF/dc ground.

## INTERFACE SCHEMATICS



Figure 3. GND Interface Schematic

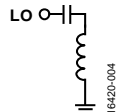

Figure 4. LO Interface Schematic

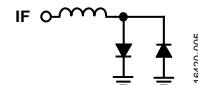

Figure 5. IF Interface Schematic

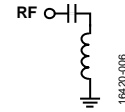

Figure 6. RF Interface Schematic

# TYPICAL PERFORMANCE CHARACTERISTICS

## DOWNCONVERTER PERFORMANCE

*IF = 100 MHz, Upper Sideband (Low-Side LO)*

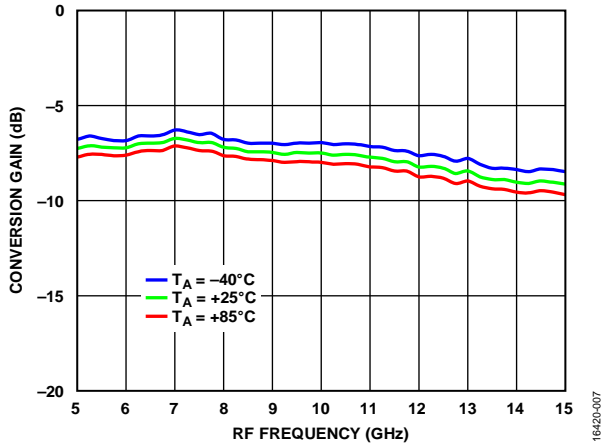

Figure 7. Conversion Gain vs. RF Frequency at Various Temperatures, LO = 13 dBm

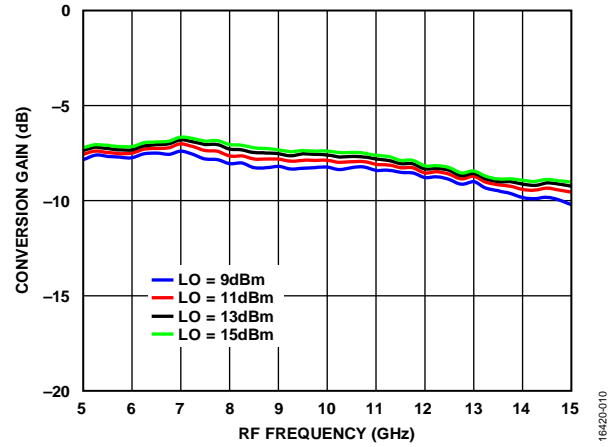

Figure 9. Conversion Gain vs. RF Frequency at Various LO Power Levels,  $T_A = 25^\circ\text{C}$

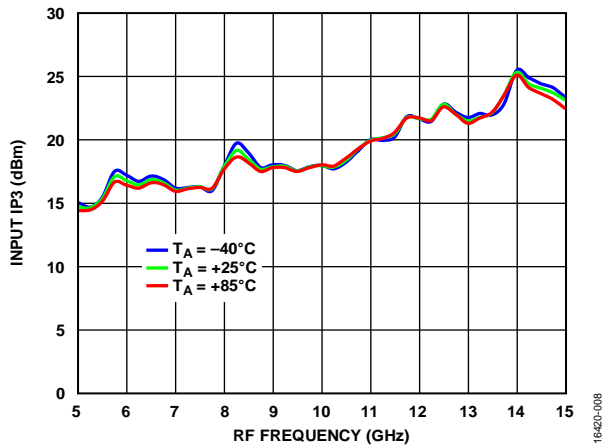

Figure 8. Input IP3 vs. RF Frequency at Various Temperatures, LO = 13 dBm

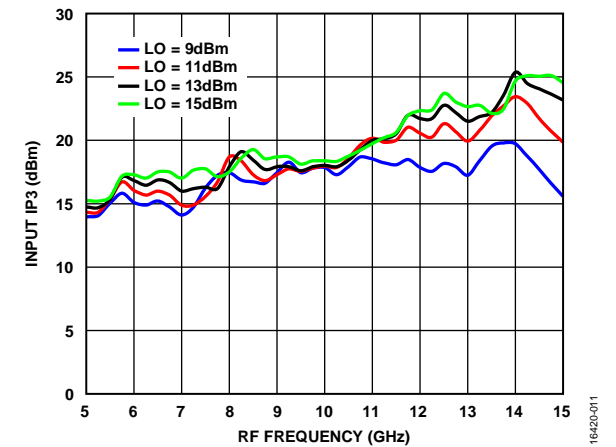

Figure 10. Input IP3 vs. RF Frequency at Various LO Power Levels,  $T_A = 25^\circ\text{C}$

**Downconverter P1dB and IP2, IF = 100 MHz, Upper Sideband (Low-Side LO)**

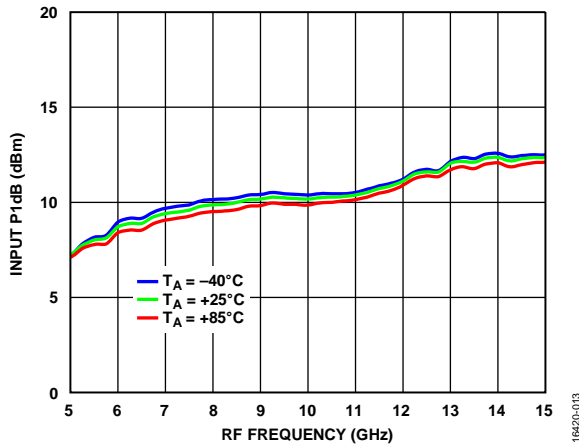

Figure 11. Input P1dB vs. RF Frequency at Various Temperatures, LO = 13 dBm

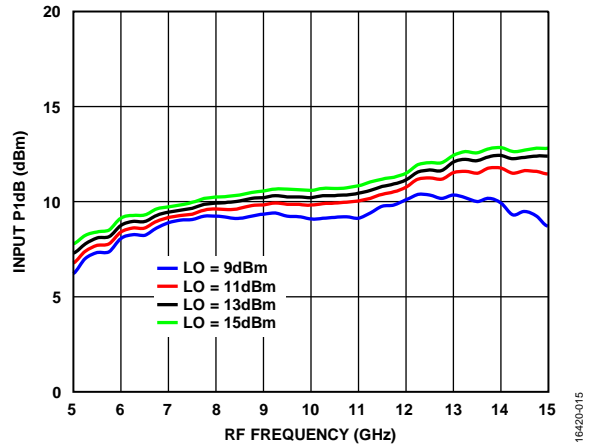

Figure 13. Input P1dB vs. RF Frequency at Various LO Power Levels, TA = 25°C

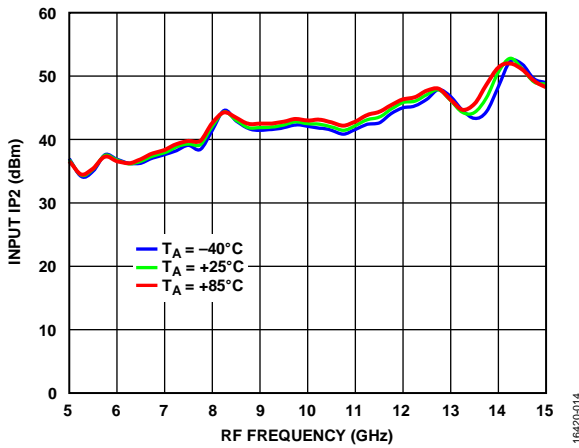

Figure 12. Input IP2 vs. RF Frequency at Various Temperatures, LO = 13 dBm

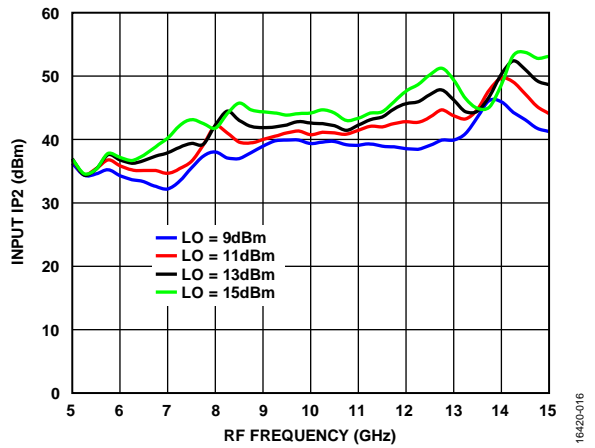

Figure 14. Input IP2 vs. RF Frequency at Various LO Power Levels, TA = 25°C

**IF = 100 MHz, Lower Sideband (High-Side LO)**

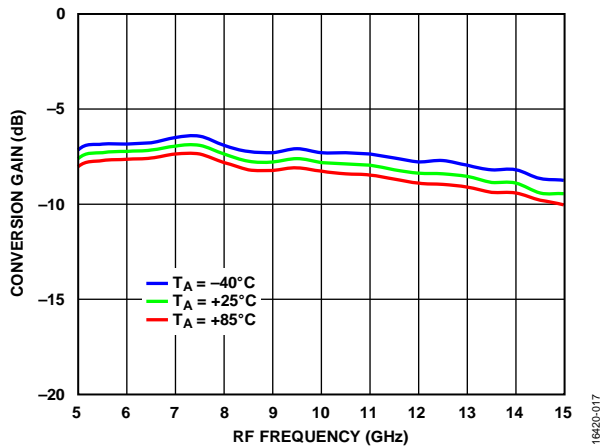

Figure 15. Conversion Gain vs. RF Frequency at Various Temperatures, LO = 13 dBm

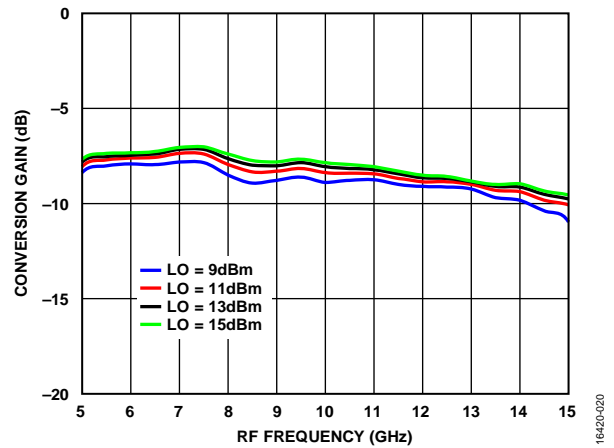

Figure 18. Conversion Gain vs. RF Frequency at Various LO Power Levels,  $T_A = 25^\circ\text{C}$

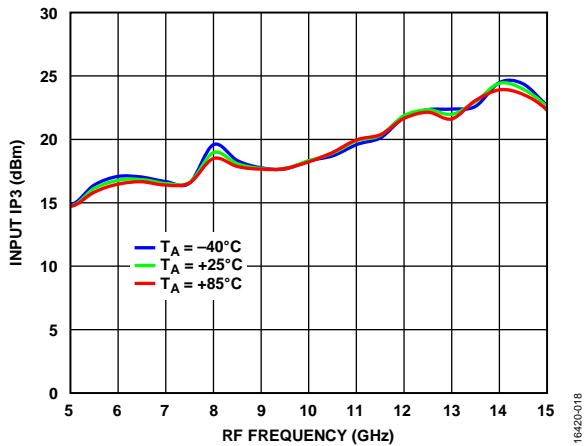

Figure 16. Input IP3 vs. RF Frequency at Various Temperatures, LO = 13 dBm

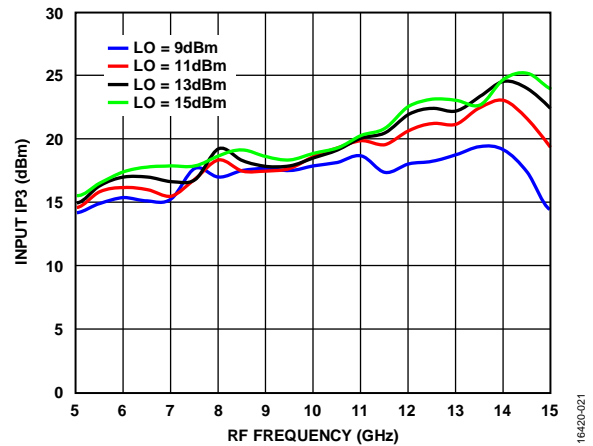

Figure 19. Input IP3 vs. RF Frequency at Various LO Power Levels,  $T_A = 25^\circ\text{C}$

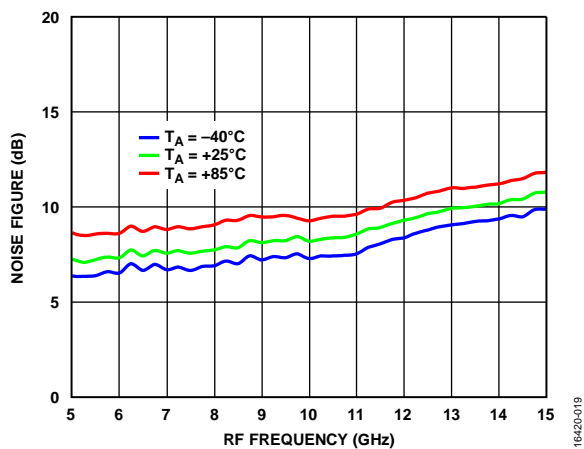

Figure 17. Noise Figure vs. RF Frequency at Various Temperatures, LO = 13 dBm

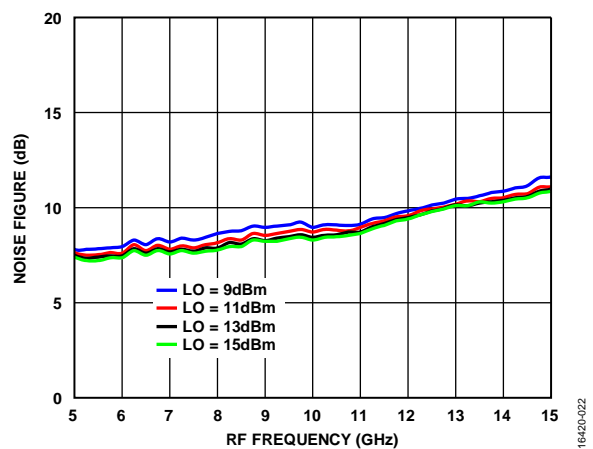

Figure 20. Noise Figure vs. RF Frequency at Various LO Power Levels,  $T_A = 25^\circ\text{C}$



**Downconverter P1dB and IP2, IF = 100 MHz, Lower Sideband (High-Side LO)**

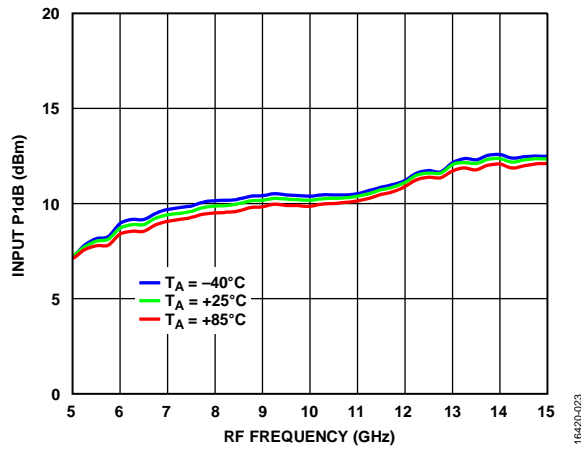

Figure 21. Input P1dB vs. RF Frequency at Various Temperatures, LO = 13 dBm

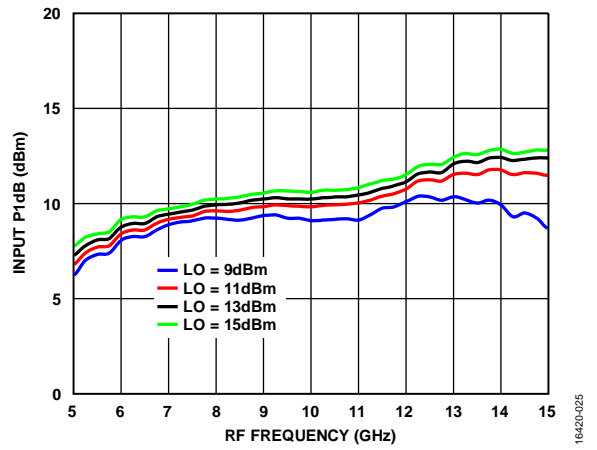

Figure 23. Input P1dB vs. RF Frequency at Various LO Power Levels, TA = 25°C

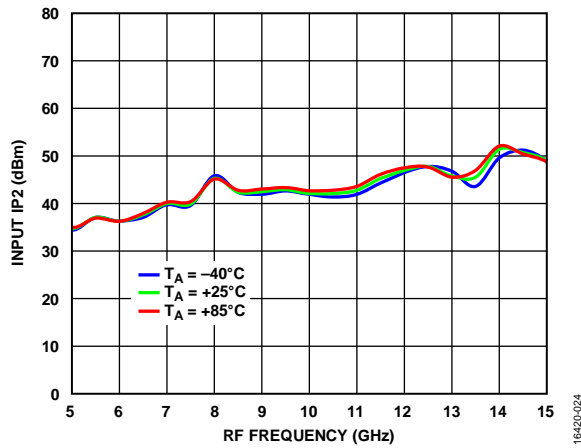

Figure 22. Input IP2 vs. RF Frequency at Various Temperatures, LO = 13 dBm

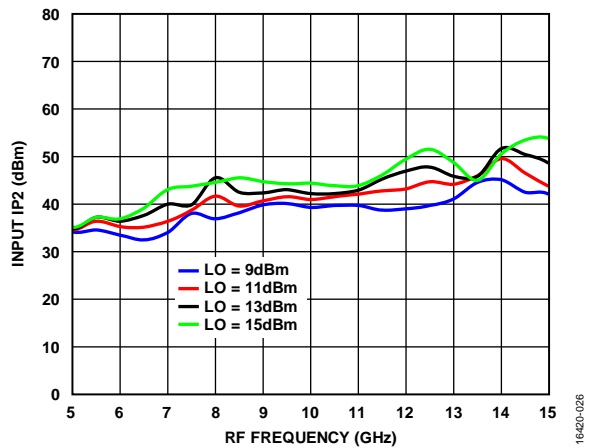

Figure 24. Input IP2 vs. RF Frequency at Various LO Power Levels, TA = 25°C

**IF = 4000 MHz, Upper Sideband (Low-Side LO)**

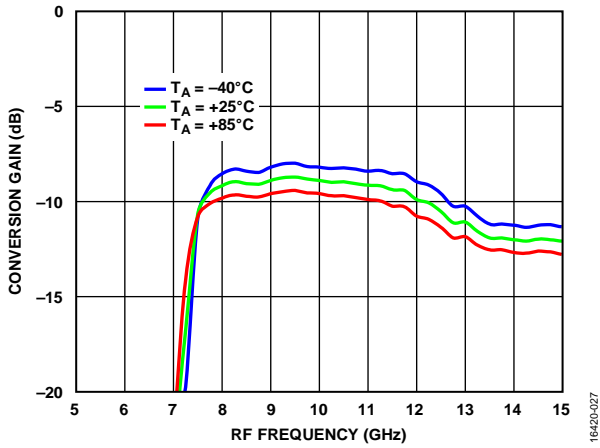

Figure 25. Conversion Gain vs. RF Frequency at Various Temperatures, LO = 13 dBm

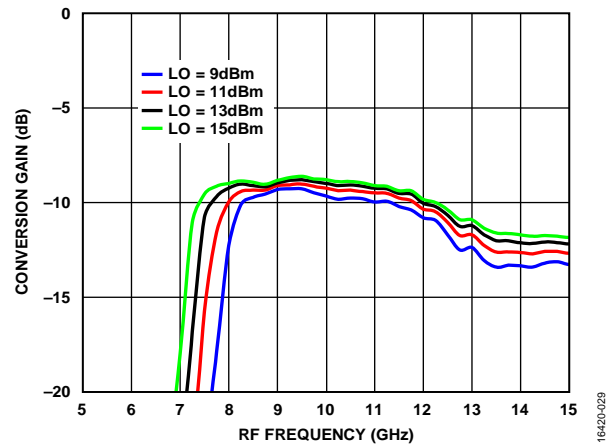

Figure 27. Conversion Gain vs. RF Frequency at Various LO Power Levels,  $T_A = 25^\circ\text{C}$

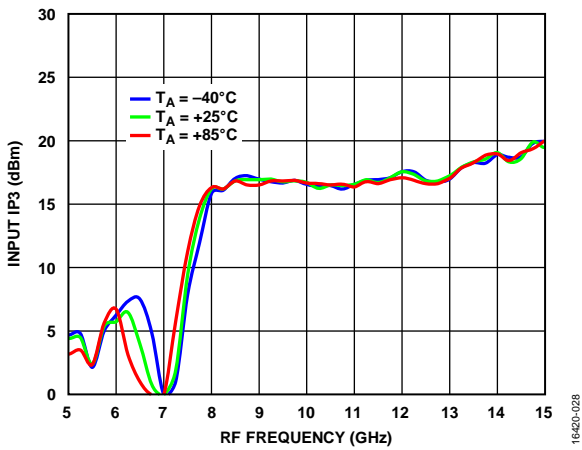

Figure 26. Input IP3 vs. RF Frequency at Various Temperatures, LO = 13 dBm

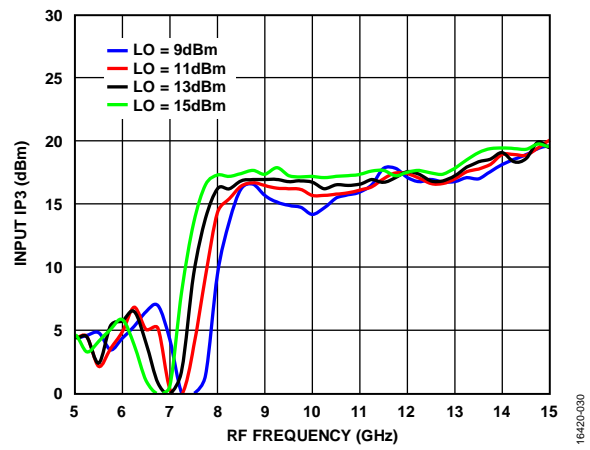

Figure 28. Input IP3 vs. RF Frequency at Various LO Power Levels,  $T_A = 25^\circ\text{C}$

**Downconverter P1dB and IP2, IF = 40000 MHz, Upper Sideband (Low-Side LO)**

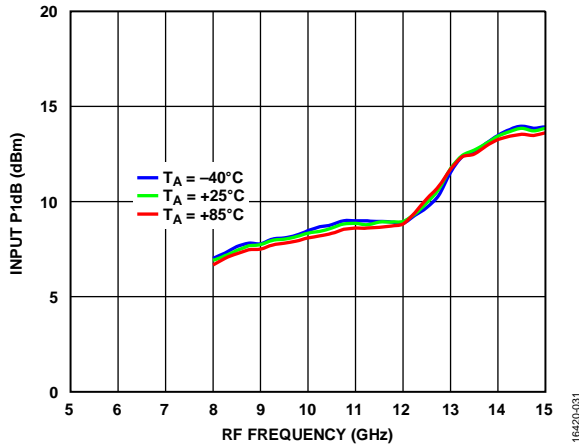

Figure 29. Input P1dB vs. RF Frequency at Various Temperatures, LO = 13 dBm

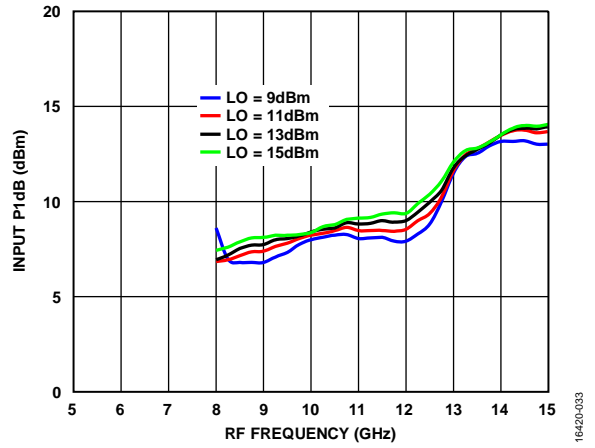

Figure 31. Input P1dB vs. RF Frequency at Various LO Power Levels, TA = 25°C

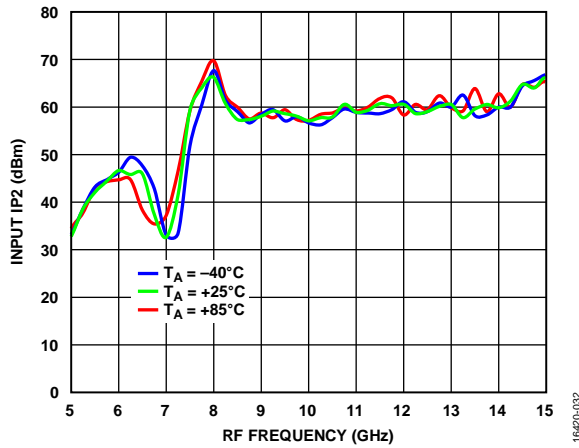

Figure 30. Input IP2 vs. RF Frequency at Various Temperatures, LO = 13 dBm

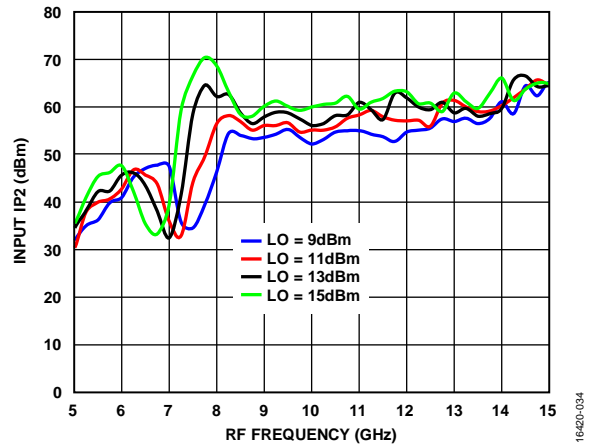

Figure 32. Input IP2 vs. RF Frequency at Various LO Power Levels, TA = 25°C

**IF = 4000 MHz, Lower Sideband (High-Side LO)**

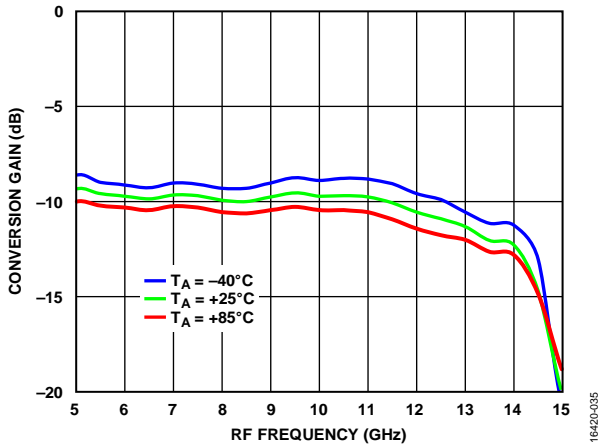

Figure 33. Conversion Gain vs. RF Frequency at Various Temperatures, LO = 13 dBm

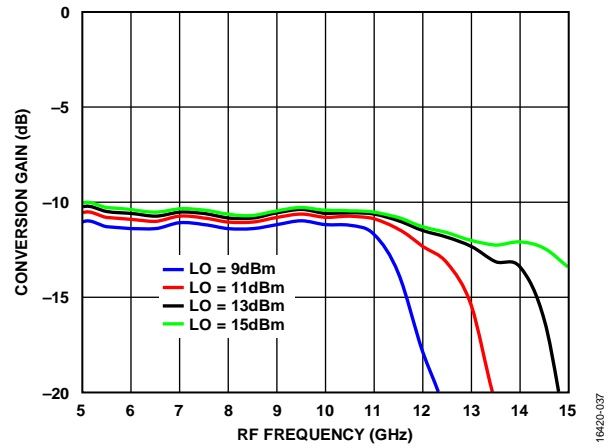

Figure 35. Conversion Gain vs. RF Frequency at Various LO Power Levels,  $T_A = 25^\circ\text{C}$

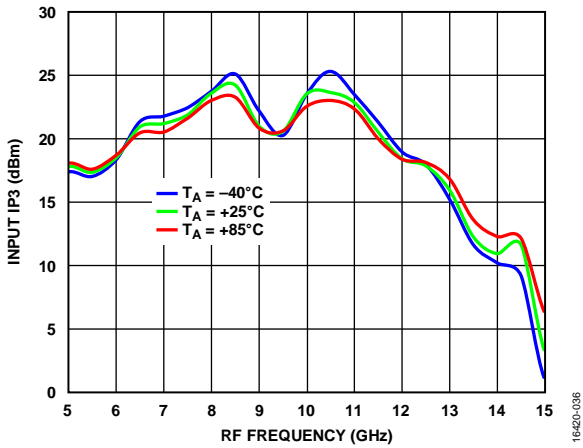

Figure 34. Input IP3 vs. RF Frequency at Various Temperatures, LO = 13 dBm

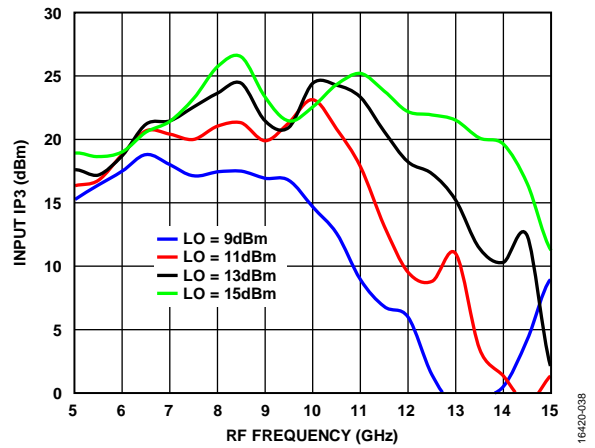

Figure 36. Input IP3 vs. RF Frequency at Various LO Power Levels,  $T_A = 25^\circ\text{C}$

Downconverter P1dB and IP2, IF = 4000 MHz, Lower Sideband (High-Side LO)

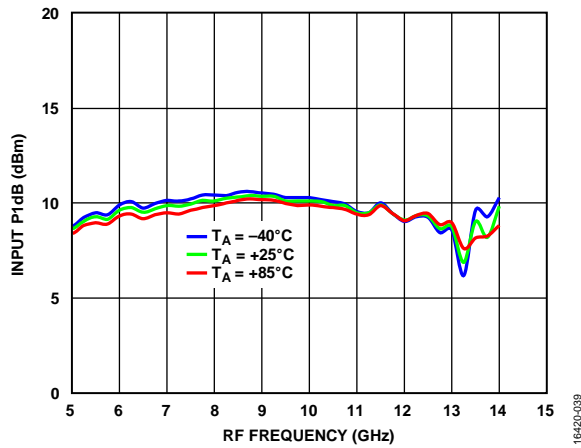

Figure 37. Input P1dB vs. RF Frequency at Various Temperatures, LO = 13 dBm

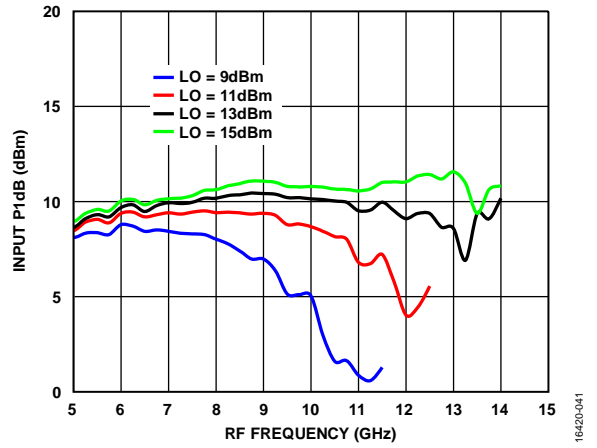

Figure 39. Input P1dB vs. RF Frequency at Various LO Power Levels,  $T_A = 25^\circ\text{C}$

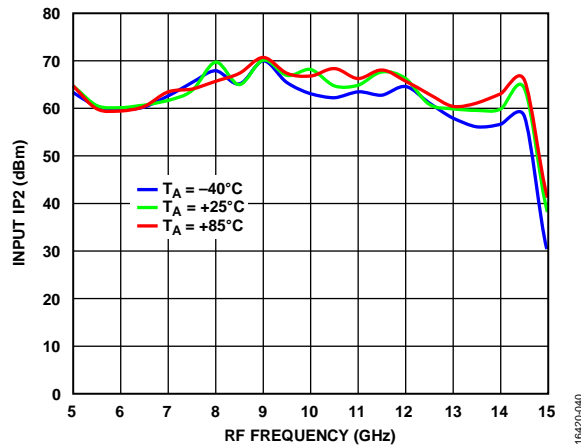

Figure 38. Input IP2 vs. RF Frequency at Various Temperatures, LO = 13 dBm

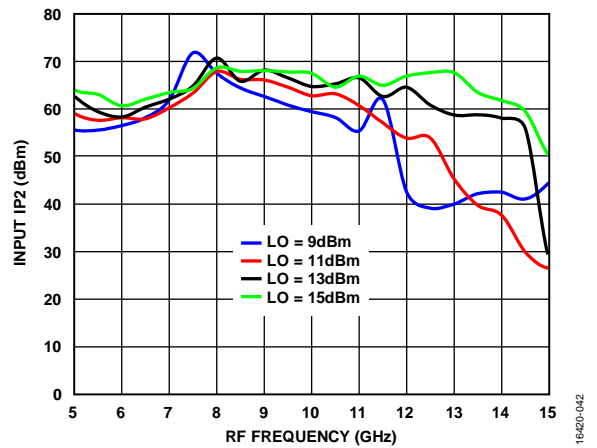

Figure 40. Input IP2 vs. RF Frequency at Various LO Power Levels,  $T_A = 25^\circ\text{C}$

UPCONVERTER PERFORMANCE

$IF_{IN} = 100 \text{ MHz}$ , Upper sideband (Low-Side LO)

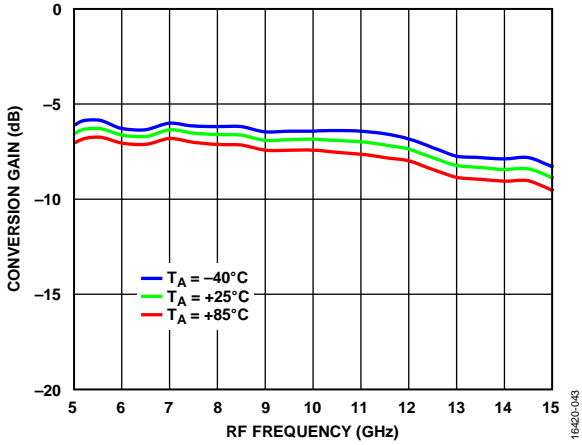

Figure 41. Conversion Gain vs. RF Frequency at Various Temperatures, LO = 13 dBm

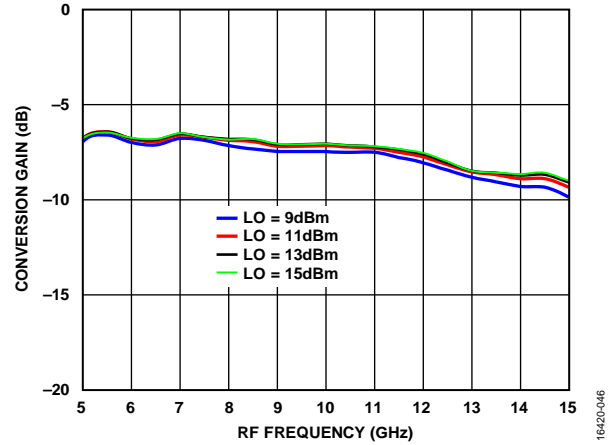

Figure 44. Conversion Gain vs. RF Frequency at Various LO Power Levels,  $T_A = 25^\circ\text{C}$

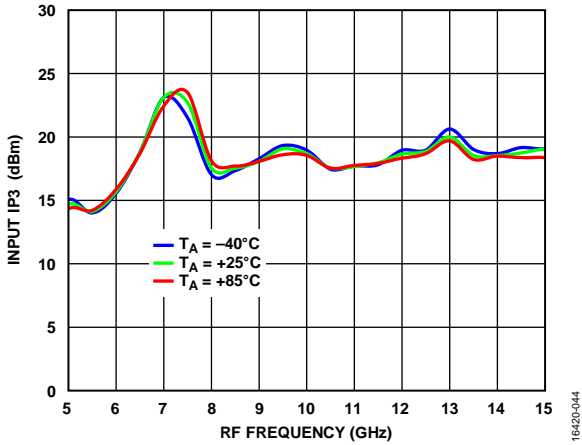

Figure 42. Input IP3 vs. RF Frequency at Various Temperatures, LO = 13 dBm

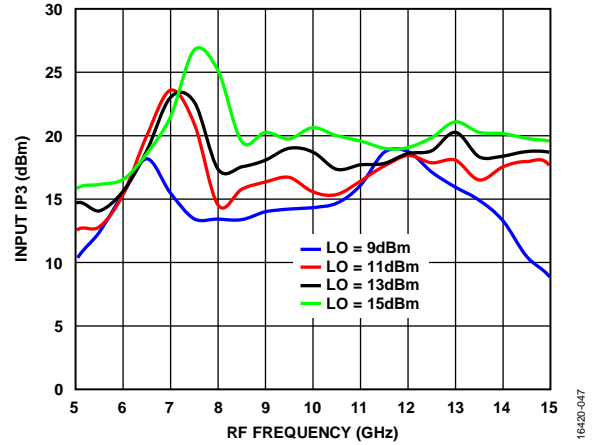

Figure 45. Input IP3 vs. RF Frequency at Various LO Power Levels,  $T_A = 25^\circ\text{C}$

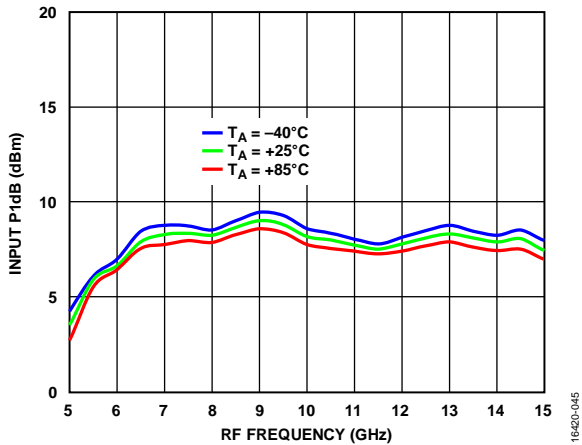

Figure 43. Input P1dB vs. RF Frequency at Various Temperatures, LO = 13 dBm

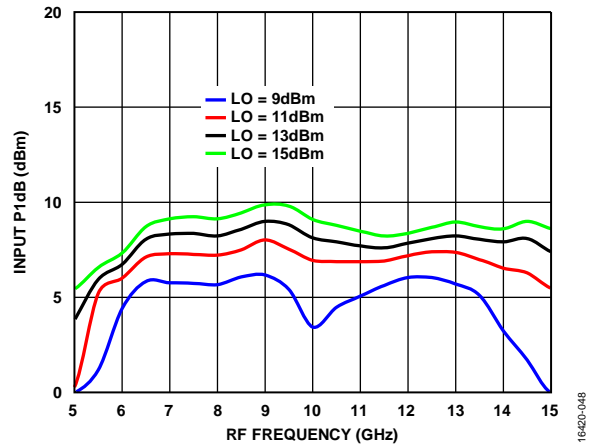

Figure 46. Input P1dB vs. RF Frequency at Various LO Power Levels,  $T_A = 25^\circ\text{C}$

$I_{F_{IN}} = 100 \text{ MHz}$ , Lower Sideband (High-Side LO)

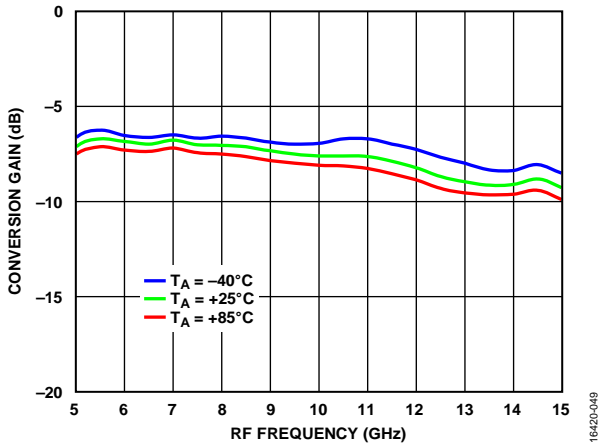

Figure 47. Conversion Gain vs. RF Frequency at Various Temperatures, LO = 13 dBm

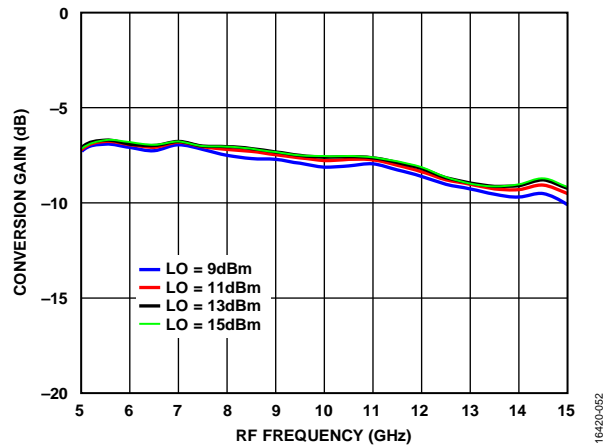

Figure 50. Conversion Gain vs. RF Frequency at Various LO Power Levels,  $T_A = 25^\circ\text{C}$

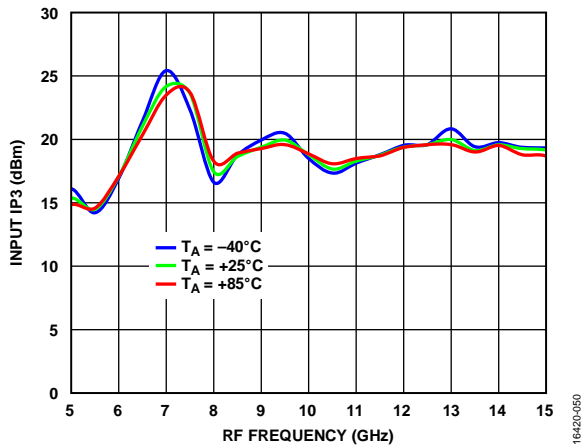

Figure 48. Input IP3 vs. RF Frequency at Various Temperatures, LO = 13 dBm

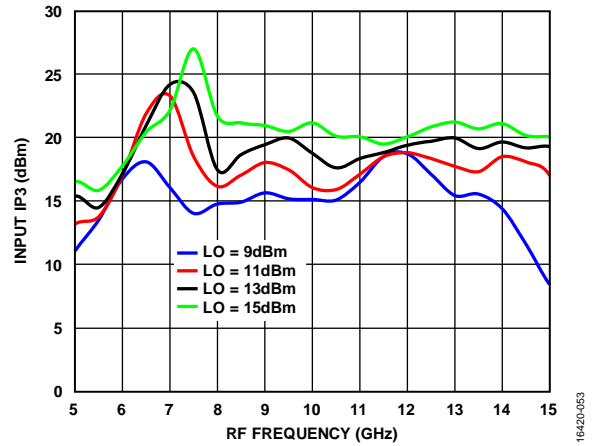

Figure 51. Input IP3 vs. RF Frequency at Various LO Power Levels,  $T_A = 25^\circ\text{C}$

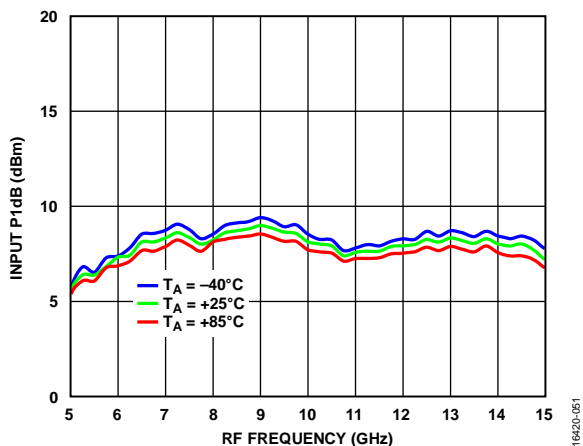

Figure 49. Input P1dB vs. RF Frequency at Various Temperatures, LO = 13 dBm

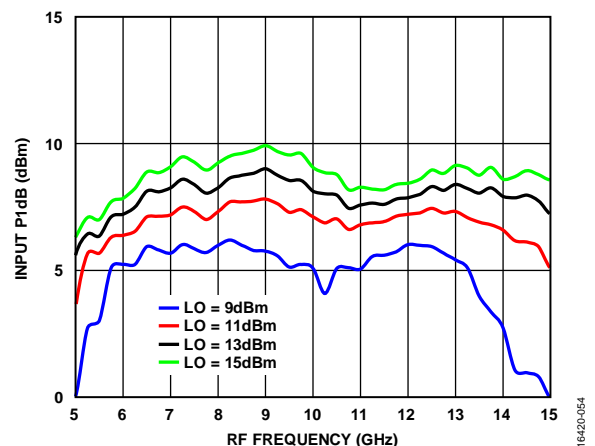

Figure 52. Input P1dB vs. RF Frequency at Various LO Power Levels,  $T_A = 25^\circ\text{C}$

$IF_{IN} = 4000 \text{ MHz}$ , Upper Sideband (Low-Side LO)

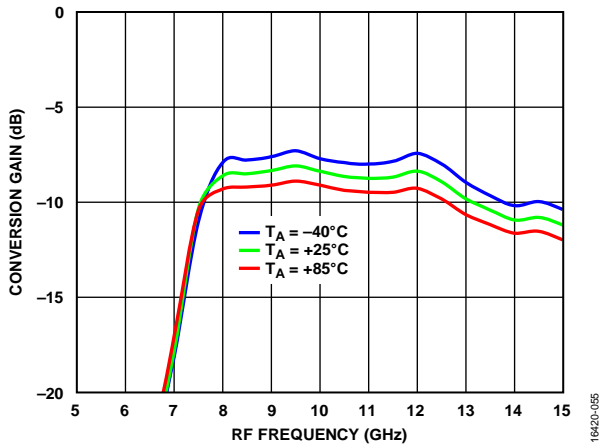

Figure 53. Conversion Gain vs. RF Frequency at Various Temperatures, LO = 13 dBm

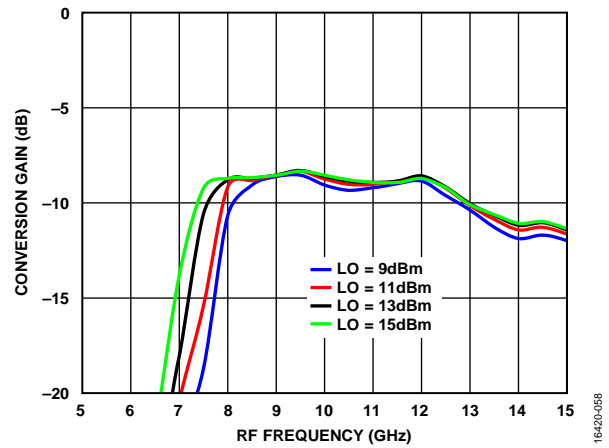

Figure 56. Conversion Gain vs. RF Frequency at Various LO Power Levels,  $T_A = 25^\circ\text{C}$

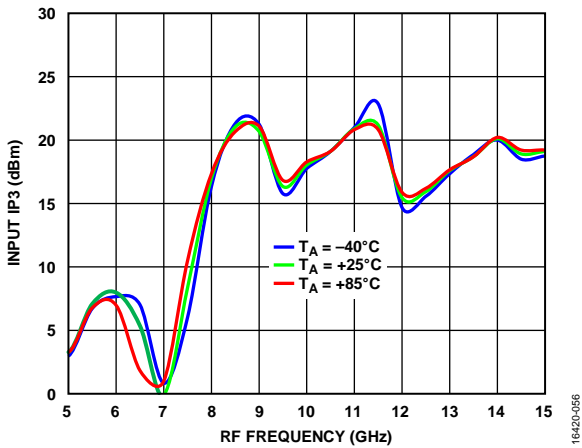

Figure 54. Input IP3 vs. RF Frequency at Various Temperatures, LO = 13 dBm

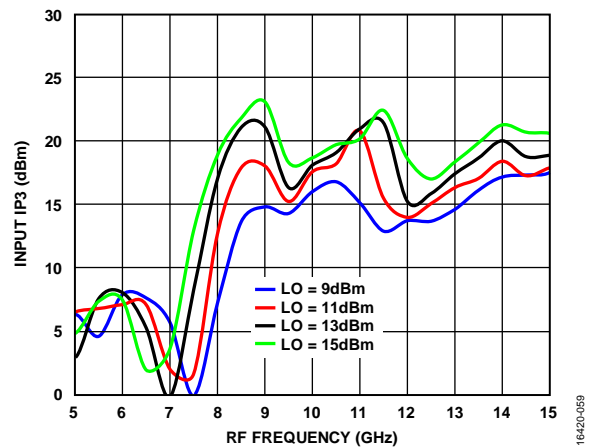

Figure 57. Input IP3 vs. RF Frequency at Various LO Power Levels,  $T_A = 25^\circ\text{C}$

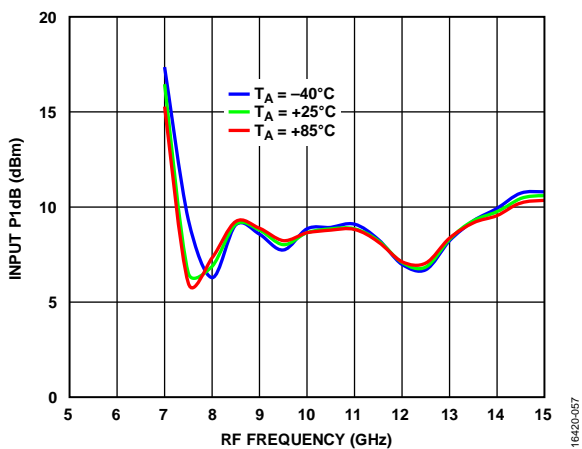

Figure 55. Input P1dB vs. RF Frequency at Various Temperatures, LO = 13 dBm

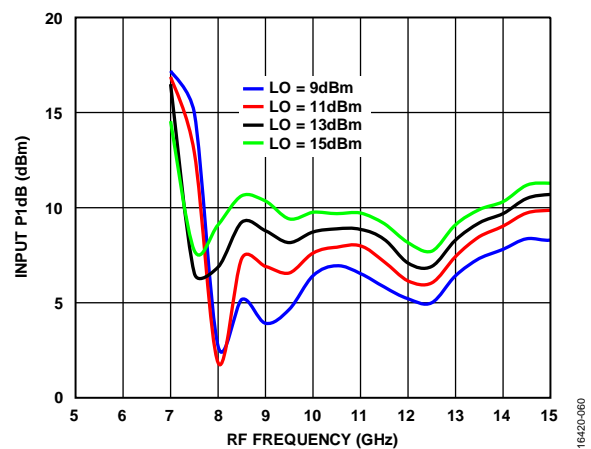

Figure 58. Input P1dB vs. RF Frequency at Various LO Power Levels,  $T_A = 25^\circ\text{C}$



**$IF_{IN} = 4000$  MHz, Lower Sideband (High-Side LO)**

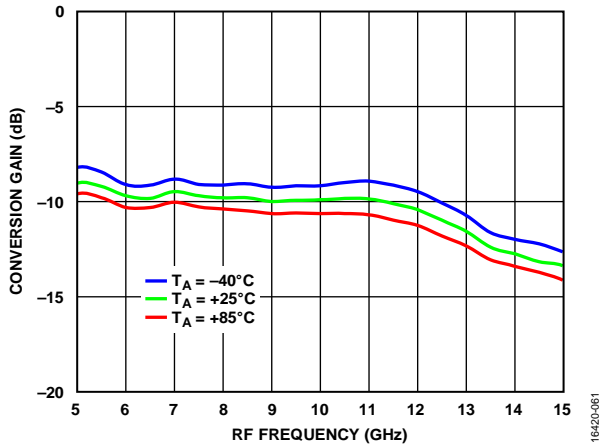

Figure 59. Conversion Gain vs. RF Frequency at Various Temperatures, LO = 13 dBm

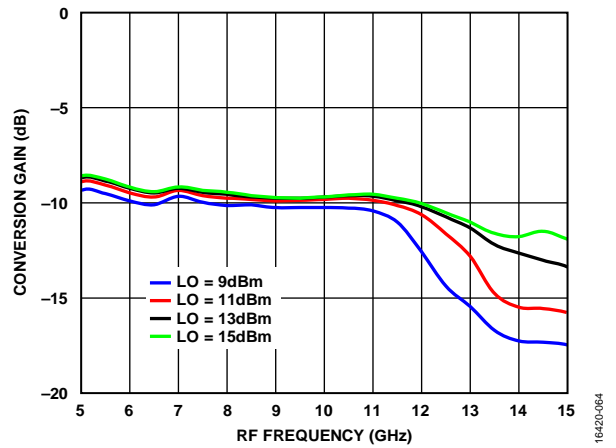

Figure 62. Conversion Gain vs. RF Frequency at Various LO Power Levels,  $T_A = 25^\circ\text{C}$

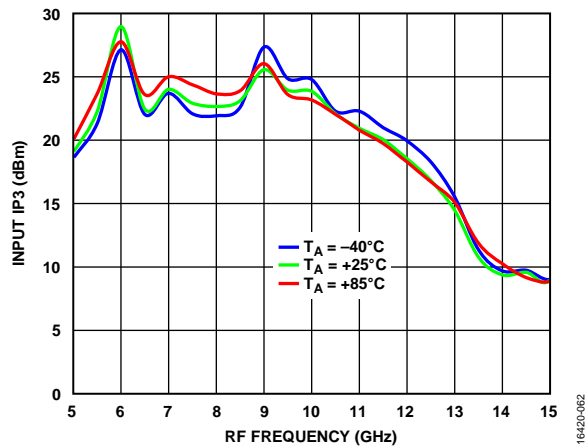

Figure 60. Input IP3 vs. RF Frequency at Various Temperatures, LO = 13 dBm

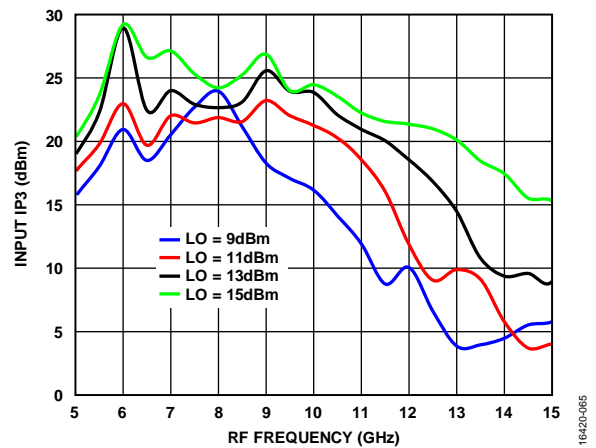

Figure 63. Input IP3 vs. RF Frequency at Various LO Power Levels,  $T_A = 25^\circ\text{C}$

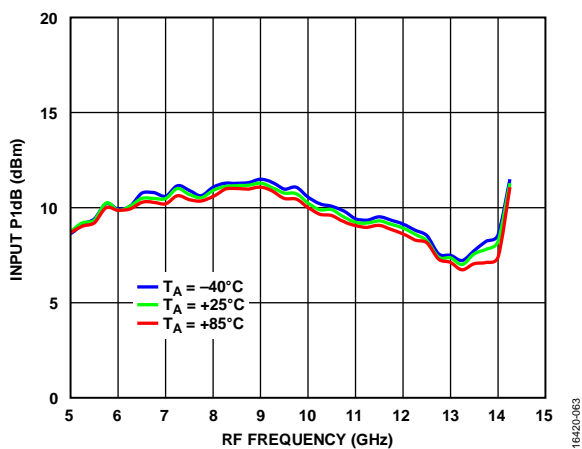

Figure 61. Input P1dB vs. RF Frequency at Various Temperatures, LO = 13 dBm

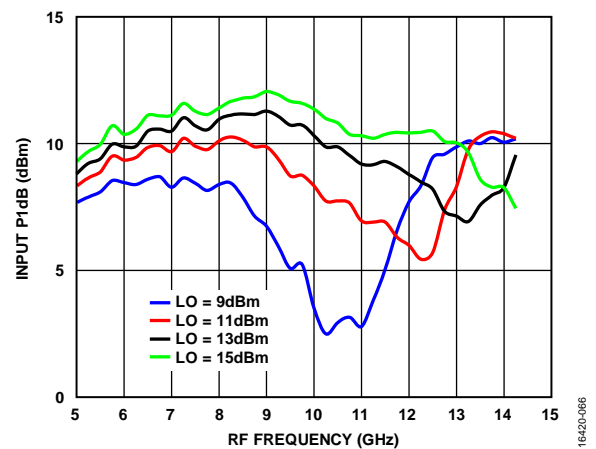

Figure 64. Input P1dB vs. RF Frequency at Various LO Power Levels,  $T_A = 25^\circ\text{C}$

**ISOLATION AND RETURN LOSS**

Downconverter performance at IF = 100 MHz, upper sideband (low-side LO).

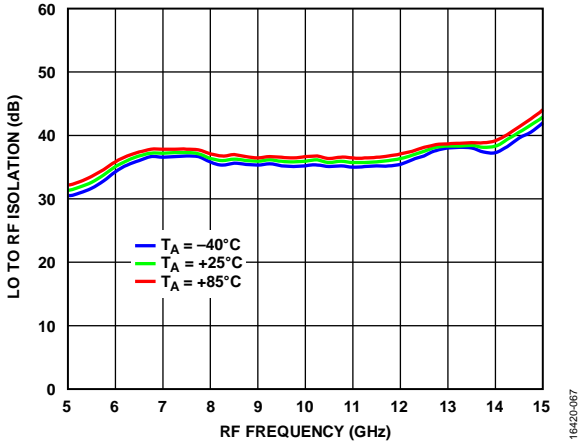

Figure 65. LO to RF Isolation vs. RF Frequency at Various Temperatures, LO = 13 dBm

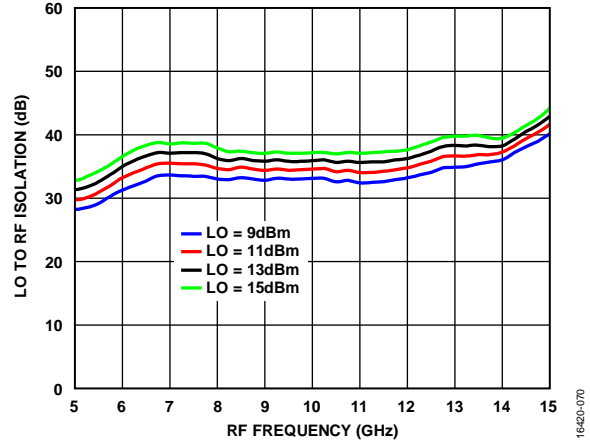

Figure 68. LO to RF Isolation vs. RF Frequency at Various LO Power Levels, TA = 25°C

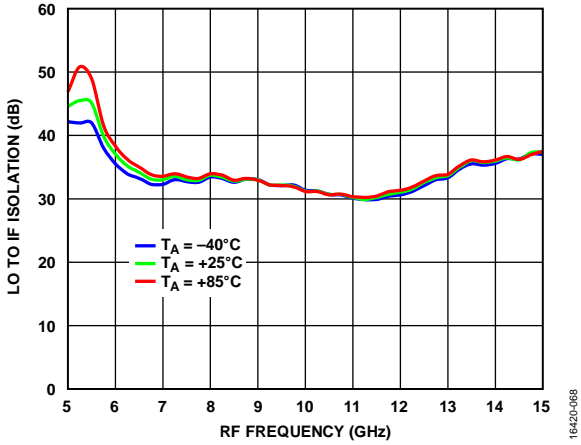

Figure 66. LO to IF Isolation vs. RF Frequency at Various Temperatures, LO = 13 dBm

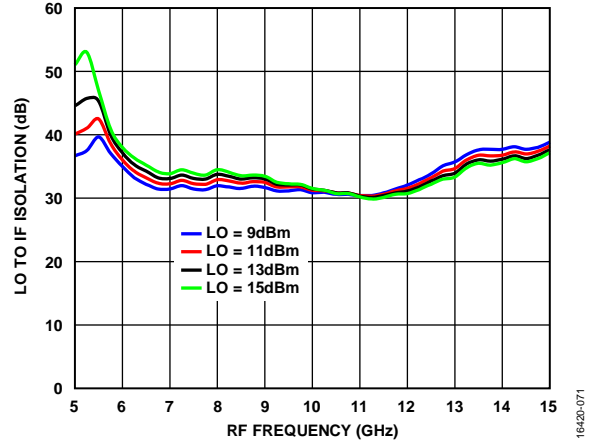

Figure 69. LO to IF Isolation vs. RF Frequency at Various LO Power Levels, TA = 25°C

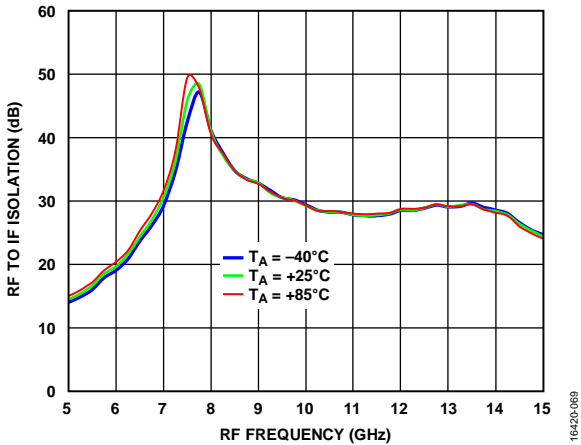

Figure 67. RF to IF Isolation vs. RF Frequency at Various Temperatures, LO = 13 dBm

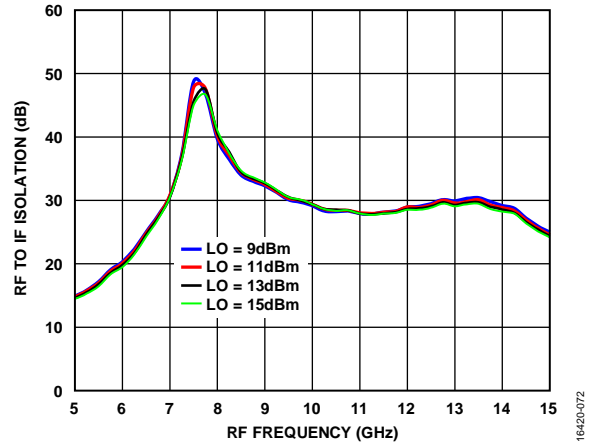

Figure 70. RF to IF Isolation vs. RF Frequency at Various LO Power Levels, TA = 25°C

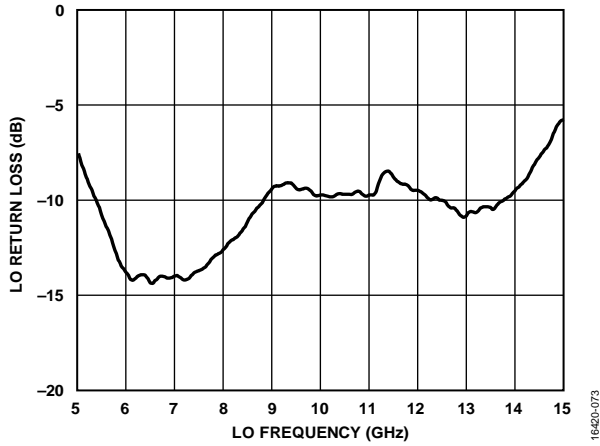

Figure 71. LO Return Loss vs. LO Frequency at LO = 13 dBm,  $T_A = 25^\circ\text{C}$

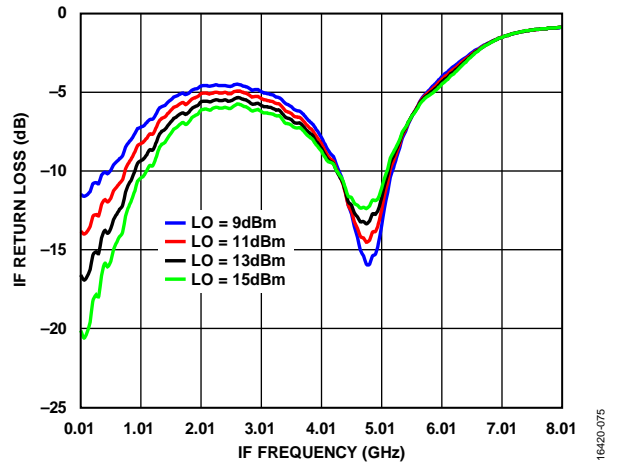

Figure 73. IF Return Loss vs. IF Frequency at LO Power Levels,  $T_A = 25^\circ\text{C}$ , LO = 10 GHz

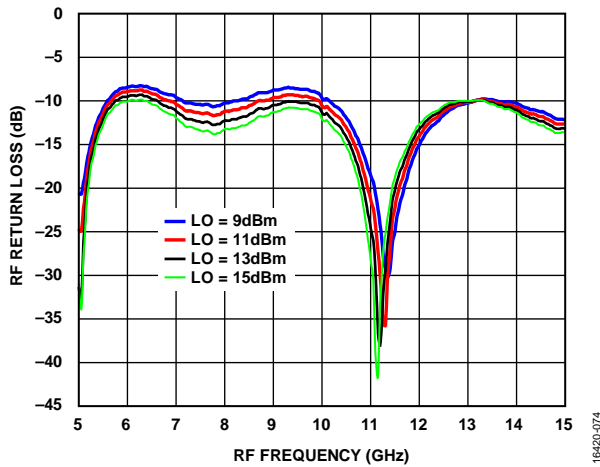

Figure 72. RF Return Loss vs. RF Frequency at LO Power Levels,  $T_A = 25^\circ\text{C}$ , LO = 10 GHz

16420-073

16420-075

16420-074

**IF BANDWIDTH—DOWNCONVERTER, UPPER SIDEBAND**

LO frequency = 8 GHz.

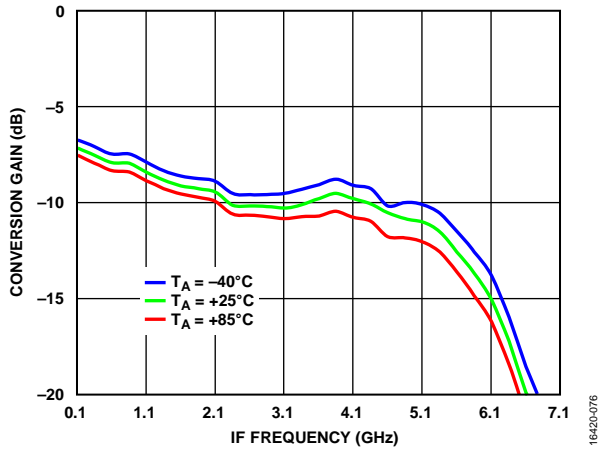

Figure 74. Conversion Gain vs. IF Frequency at Various Temperatures, LO = 13 dBm

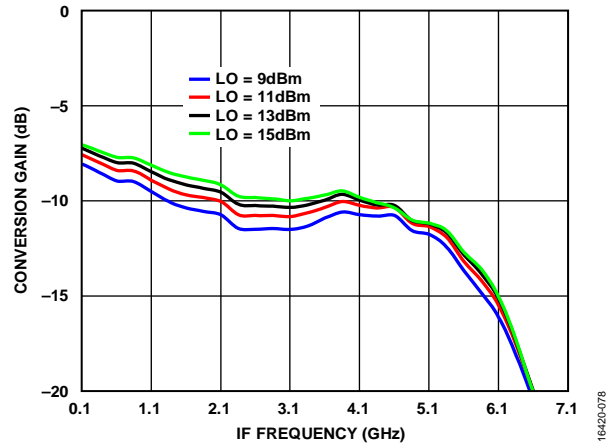

Figure 76. Conversion Gain vs. IF Frequency at Various LO Power Levels, TA = 25°C

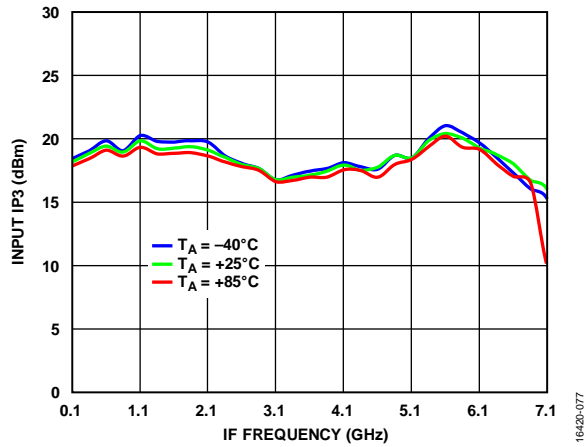

Figure 75. Input IP3 vs. IF Frequency at Various Temperatures, LO = 13 dBm

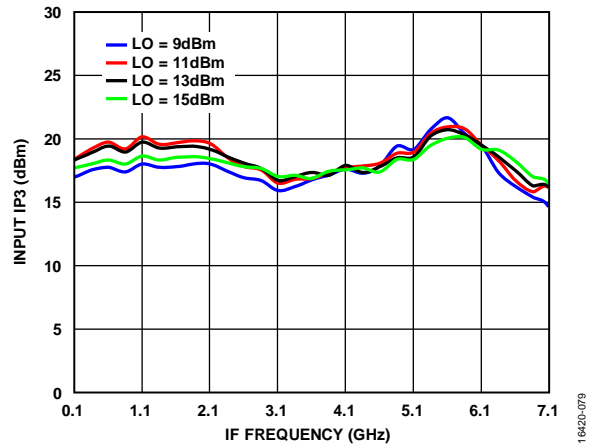

Figure 77. Input IP3 vs. IF Frequency at Various LO Power Levels, TA = 25°C

**IF BANDWIDTH—DOWNCONVERTER, LOWER SIDEBAND**

LO frequency = 13 GHz.

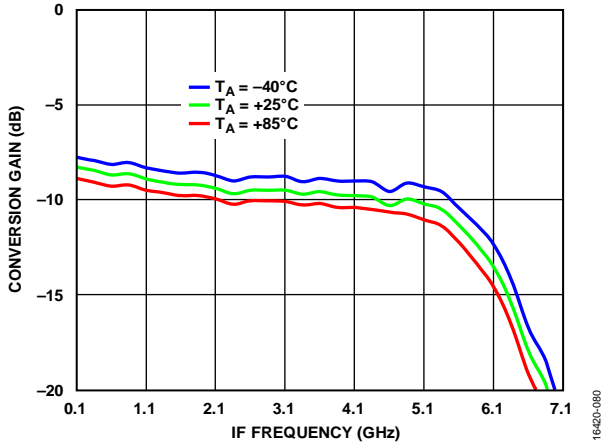

Figure 78. Conversion Gain vs. IF Frequency at Various Temperatures, LO = 13 dBm

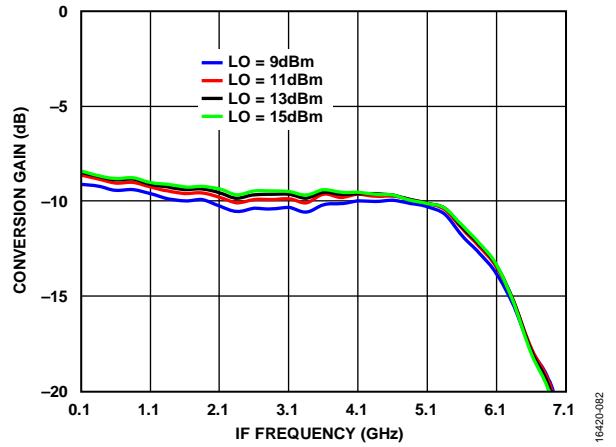

Figure 80. Conversion Gain vs. IF Frequency at Various LO Power Levels, TA = 25°C

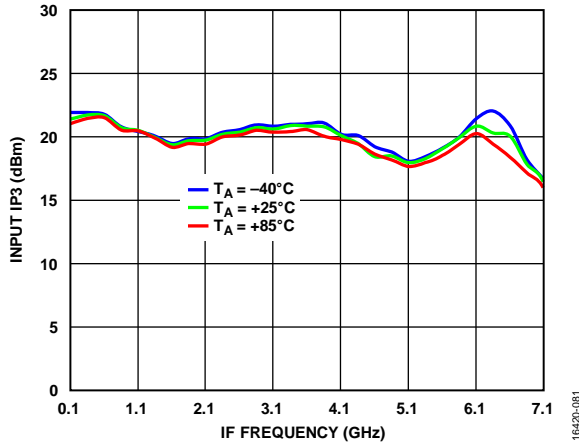

Figure 79. Input IP3 vs. IF Frequency at Various Temperatures, LO = 13 dBm

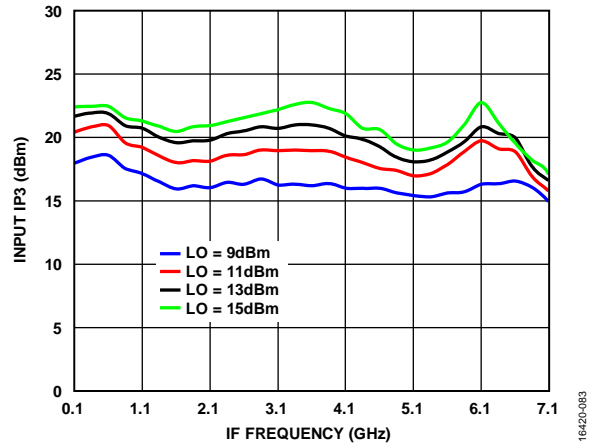

Figure 81. Input IP3 vs. IF Frequency at Various LO Power Levels, TA = 25°C

**SPURIOUS AND HARMONICS PERFORMANCE**

**LO Harmonics**

LO = 13 dBm, all values in dBc below input LO level and measured at RF port. N/A means not applicable.

**Table 5. LO Harmonics at RF**

LO Frequency (GHz)	N × LO Spur at RF Port (dBc)			
	1	2	3	4
6	37	21	51	53
8	38	41	43	64
9	38	46	49	70
10	37	45	58	82
12	37	50	45	105
14	39	50	71	N/A

LO = 13 dBm, all values in dBc below input LO level and measured at IF port. N/A means not applicable.

**Table 6. LO Harmonics at IF**

LO Frequency (GHz)	N × LO Spur at IF Port (dBc)			
	1	2	3	4
6	43	38	60	74
8	28	50	88	104
9	29	66	102	109
10	29	76	103	108
12	31	84	88	10
14	43	93	107	N/A

**M × N Spurious Outputs**

**Downconversion, Upper Sideband**

Spur values are  $(M \times RF) - (N \times LO)$ . RF = 10.1 GHz, LO = 10 GHz, RF power = -10 dBm, and LO power = 13 dBm. Mixer spurious products are measured in dBc from the IF output power level. N/A means not applicable.

M × RF		N × LO				
		0	1	2	3	4
	0	N/A	0.6	26	25	N/A
	1	22	0	44	70	68
	2	71	67	58	70	78
	3	84	92	93	71	91
	4	N/A	82	93	98	101

**Downconversion, Lower Sideband**

Spur values are  $(M \times RF) - (N \times LO)$ . RF = 14 GHz, LO = 14.1 GHz, RF power = -10 dBm, and LO power = 13 dBm. Mixer spurious products are measured in dBc from the IF output power level. N/A means not applicable.

M × RF		N × LO				
		0	1	2	3	4
	0	N/A	3	26	N/A	N/A
	1	18	0	40	65	N/A
	2	55	72	70	77	56
	3	N/A	57	93	74	89
	4	N/A	N/A	58	95	101

**Upconversion, Upper Sideband**

Spur values are  $(M \times IF_{IN}) + (N \times LO)$ .  $IF_{IN} = 0.1$  GHz, LO = 10 GHz, RF power = -10 dBm, and LO power = 13 dBm. Mixer spurious products are measured in dBc from the RF output power level. N/A means not applicable.

M × IF <sub>IN</sub>		N × LO				
		0	1	2	3	4
	-5	N/A	99	96	64	61
	-4	N/A	86	94	62	61
	-3	N/A	81	83	75	61
	-2	N/A	51	59	72	59
	-1	N/A	0	35	22	43
	0	N/A	6	10	27	19
	+1	36	0	36	20	N/A
	+2	81	50	58	68	N/A
	+3	95	63	84	76	N/A
	+4	101	85	92	84	N/A
	+5	102	100	94	84	N/A

**Upconversion, Lower Sideband**

Spur values are  $(M \times IF_{IN}) + (N \times LO)$ .

$IF_{IN} = 0.1$  GHz, LO = 14.1 GHz, RF power = -10 dBm, and LO power = 13 dBm. Mixer spurious products are measured in dBc from the RF output power level. N/A means not applicable.

M × IF <sub>IN</sub>		N × LO				
		0	1	2	3	4
	-5	N/A	96	82	N/A	N/A
	-4	N/A	85	84	N/A	N/A
	-3	N/A	71	77	N/A	N/A
	-2	N/A	52	60	N/A	N/A
	-1	N/A	0	28	N/A	N/A
	0	N/A	8	20	N/A	N/A
	+1	34	0	28	N/A	N/A
	+2	79	50	61	N/A	N/A
	+3	96	63	61	N/A	N/A
	+4	100	86	84	N/A	N/A
	+5	100	95	62	N/A	N/A

## THEORY OF OPERATION

The HMC553ALC3B is a general-purpose, double-balanced mixer that can be used as an upconverter or a downconverter from 6 GHz to 14 GHz.

When used as a downconverter, the HMC553ALC3B downconverts radio frequencies (RF) between 6 GHz and 14 GHz to intermediate frequencies (IF) between dc and 5 GHz.

When used as an upconverter, the mixer upconverts intermediate frequencies between dc and 5 GHz to radio frequencies between 6 GHz and 14 GHz.

## APPLICATIONS INFORMATION

### TYPICAL APPLICATION CIRCUIT

Figure 82 shows the typical application circuit for the HMC553ALC3B. The HMC553ALC3B is a passive device and does not require any external components. The LO and RF pins are internally ac-coupled. The IF pin is internally dc-coupled. When IF operation to dc is not required, use of an external series capacitor is recommended, of a value chosen to pass the necessary IF frequency range. When IF operation to dc is required, do not exceed the IF source and sink current rating specified in the Absolute Maximum Ratings section.

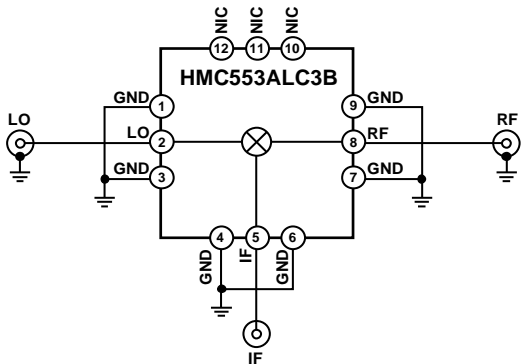

Figure 82. Typical Application Circuit

### EVALUATION PCB INFORMATION

Use RF circuit design techniques for the circuit board used in the application. Ensure that signal lines have 50 Ω impedance, and connect the package ground leads and the exposed pad directly to the ground plane (see Figure 83). Use a sufficient number of via holes to connect the top and bottom ground planes. The evaluation circuit board shown in Figure 83 is available from Analog Devices, Inc., upon request.

Table 7. List of Materials for Evaluation PCB

#### EV1HMC553ALC3B

Item	Description
J1, J2	SRI 2.92 mm connector
J3	Johnson Surface-Mount Type A (SMA) connector
U1	HMC553ALC3B
PCB <sup>1</sup>	117611-7 evaluation board

<sup>1</sup> 117611-7 is the raw bare PCB identifier. Reference EV1HMC553ALC3B when ordering the complete evaluation PCB.

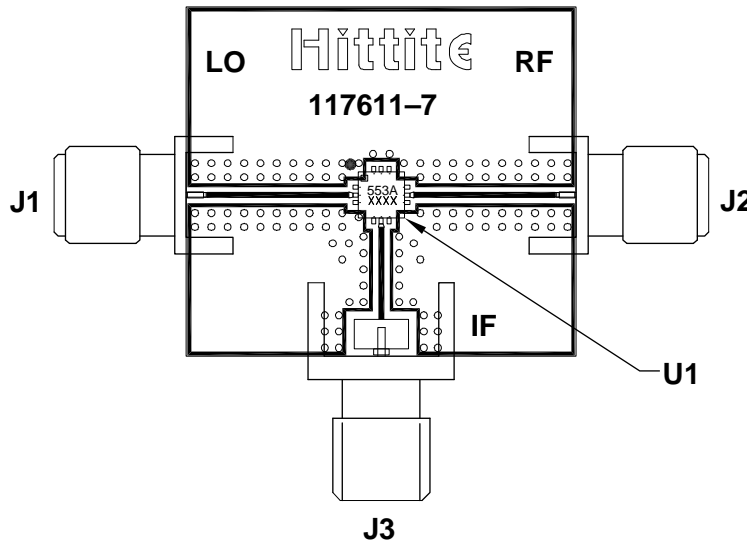

Figure 83. Evaluation PCB Top Layer