

Ceramic Bandpass Filter

BFCN-5750+

50Ω 5650 to 5850 MHz

Features

- Passband VSWR, 1.2:1
- Small size (0.126"x0.063"x0.037")
- Temperature stable
- Hermetically sealed
- LTCC construction

Applications

- WiFi
- WLAN
- Harmonic Rejection

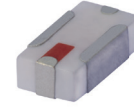

Generic photo used for illustration purposes only

CASE STYLE: FV1206-4

+RoHS Compliant

The +Suffix identifies RoHS Compliance. See our web site for RoHS Compliance methodologies and qualifications



Available Tape and Reel at no extra cost

Reel Size	Devices/Reel
7"	20, 50, 100, 200, 500, 1000, 3000

Specification Definition

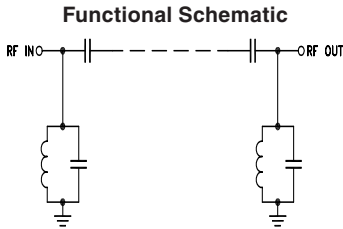
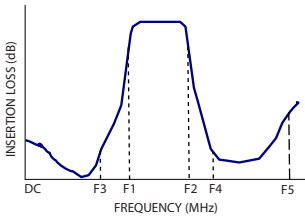

Functional Schematic

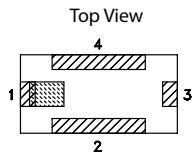

Pad Connections

Input	1
Output	3
Ground	2,4

Electrical Specifications^{1,2} at 25°C

Parameter	F#	Frequency (MHz)	Min.	Typ.	Max.	Unit	
Pass Band	Center Frequency	—	—	5750	—	MHz	
	Insertion Loss	F1 - F2	5650 - 5850	—	1.85	2.5	dB
	VSWR	F1 - F2	5650 - 5850	—	1.25	—	:1
Stop Band, Lower	Insertion Loss	DC - F3	—	—	25	—	dB
	VSWR	DC - F3	—	—	30	—	:1
Stop Band, Upper	Insertion Loss	F4 - F5	8000 - 9500	—	25	—	dB
	VSWR	F4 - F5	8000 - 9500	—	50	—	:1

1. Measured on Mini-Circuits Characterization Test Board TB-518+.

2. This filter is not intended for use as a DC Blocking circuit element. In Application where DC voltage is present at either input or output ports, blocking capacitors are required at the corresponding RF port.

Maximum Ratings

Operating Temperature	-40°C to +85°C
Storage Temperature	-55°C to +100°C
RF Power Input*	2W at 25°C

*Passband rating, derate linearly to 0.5W at 85°C ambient
Permanent damage may occur if any of these limits are exceeded.

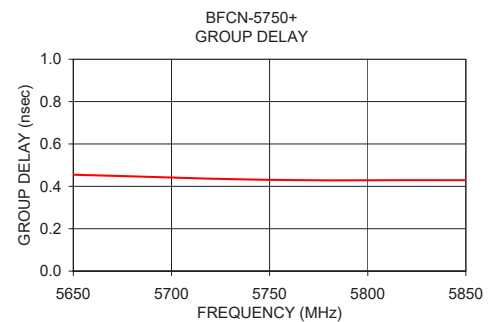
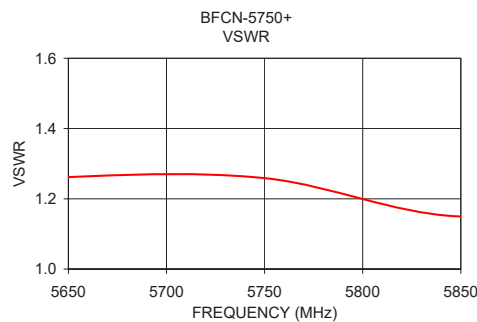
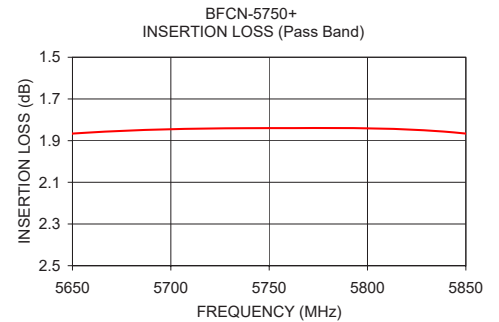
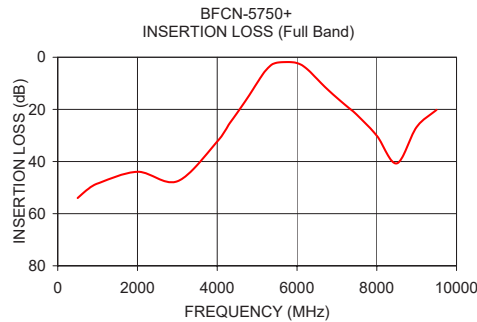

Full Band Performance

Frequency (MHz)	Insertion Loss (dB)	VSWR (:1)
500.00	54.00	72.02
1000.00	48.44	61.34
2000.00	43.94	53.75
4300.00	25.62	30.28
5200.00	5.33	4.06
5650.00	1.87	1.26
5750.00	1.84	1.26
5850.00	1.87	1.15
6300.00	5.19	4.26
8000.00	30.11	499.57
9000.00	26.78	402.78
9500.00	20.18	73.66

Pass Band Performance

Frequency (MHz)	Insertion Loss (dB)	Group Delay (nsec)
5650.00	1.87	0.45
5750.00	1.84	0.43
5850.00	1.87	0.43

Pad Connections

Input	1
Output	3
Ground	2,4

Outline Drawing

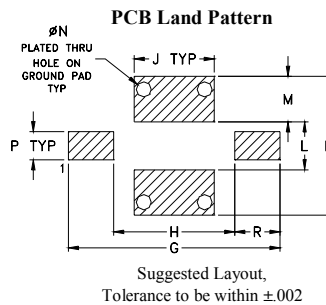
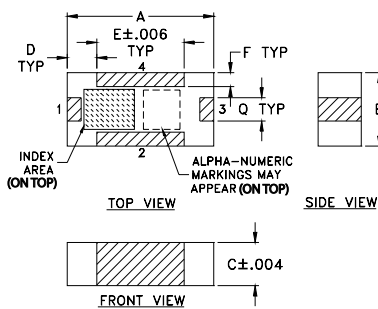

Demo Board MCL P/N: TB-518+ Suggested PCB Layout (PL-305)

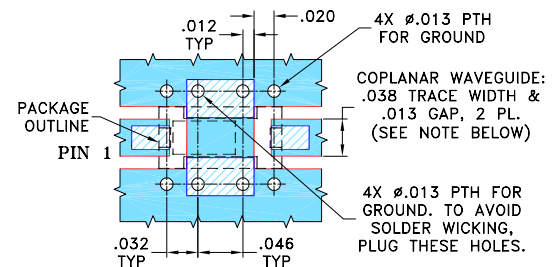

- NOTE: 1. TRACE WIDTH IS SHOWN FOR ROGERS R04350B WITH DIELECTRIC THICKNESS $.020" \pm .0015"$. COPPER: 1/2 OZ. EACH SIDE. FOR OTHER MATERIALS TRACE WIDTH MAY NEED TO BE MODIFIED.
2. BOTTOM SIDE OF THE PCB IS CONTINUOUS GROUND PLANE.

- DENOTES PCB COPPER LAYOUT WITH SMOBC (SOLDER MASK OVER BARE COPPER)
- DENOTES COPPER LAND PATTERN FREE OF SOLDER MASK

Outline Dimensions (inch/mm)

A	B	C	D	E	F	G	H	J
.126	.063	.037	.026	.075	.012	.182	.104	.069
3.20	1.60	0.94	0.66	1.91	0.30	4.62	2.64	1.75
K	L	M	N	P	Q	R		wt
.119	.041	.039	.013	.024	.020	.039		grams
3.02	1.04	0.99	0.33	0.61	0.51	0.99		.020

Additional Notes

- A. Performance and quality attributes and conditions not expressly stated in this specification document are intended to be excluded and do not form a part of this specification document.
- B. Electrical specifications and performance data contained in this specification document are based on Mini-Circuit's applicable established test performance criteria and measurement instructions.
- C. The parts covered by this specification document are subject to Mini-Circuits standard limited warranty and terms and conditions (collectively, "Standard Terms"); Purchasers of this part are entitled to the rights and benefits contained therein. For a full statement of the Standard Terms and the exclusive rights and remedies thereunder, please visit Mini-Circuits' website at www.minicircuits.com/MCLStore/terms.jsp