

GaAs MMIC SPDT NON-REFLECTIVE SWITCH, DC - 14 GHz

Typical Applications

The HMC347ALP3E is ideal for:

- Basestation Infrastructure
- Fiber Optics & Broadband Telecom
- Microwave Radio & VSAT
- Military Radios, Radar, & ECM
- Test Instrumentation

Features

- High Isolation: >54 dB up to 3 GHz
>44 dB up to 10 GHz
- Low Insertion Loss: 1.8 dB @ 10 GHz
- Non-Reflective Design
- 3x3 mm QFN SMT Package

Functional Diagram

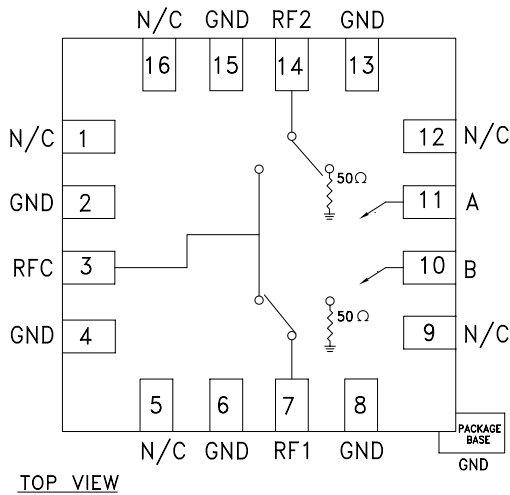

General Description

The HMC347ALP3E is a broadband high isolation non-reflective GaAs pHEMT SPDT switch in low cost leadless QFN surface mount plastic package. Covering DC to 14 GHz, the switch offers high isolation and low insertion loss. The switch features >54 dB isolation up to 3 GHz and >44 dB isolation up to 13 GHz. The switch operates using complementary negative control voltage logic lines of -5/0V and requires no bias supply.

Electrical Specifications, $T_A = +25^\circ\text{C}$, With 0/-5V Control, 50 Ohm System

Parameter	Frequency	Min.	Typ.	Max.	Units
Insertion Loss	DC - 3.0 GHz		1.5	1.9	dB
	DC - 6.0 GHz		1.7	2.1	dB
	DC - 12.0 GHz		1.9	2.4	dB
	DC - 14.0 GHz		2.0	2.5	dB
Isolation	DC - 3.0 GHz	50	54		dB
	DC - 6.0 GHz	44	48		dB
	DC - 12.0 GHz	40	44		dB
	DC - 14.0 GHz	34	40		dB
Return Loss RFC	"On State"	DC - 6.0 GHz	14	17	dB
		DC - 14.0 GHz	12	17	dB
Return Loss RF1, RF2	"Off State"	DC - 6.0 GHz	23	26	dB
		DC - 14.0 GHz	15	18	dB
Input Power for 1 dB Compression	0.5 - 14.0 GHz	24	29		dBm
Input Third Order Intercept (Two-Tone Input Power= +7 dBm Each Tone)	0.5 - 14.0 GHz	42	47		dBm
Switching Characteristics	DC - 14 GHz	tRISE, tFALL (10/90% RF)		2	ns
		tON, tOFF (50% CTL to 10/90% RF)		10	ns

GaAs MMIC SPDT NON-REFLECTIVE SWITCH, DC - 14 GHz

Insertion Loss

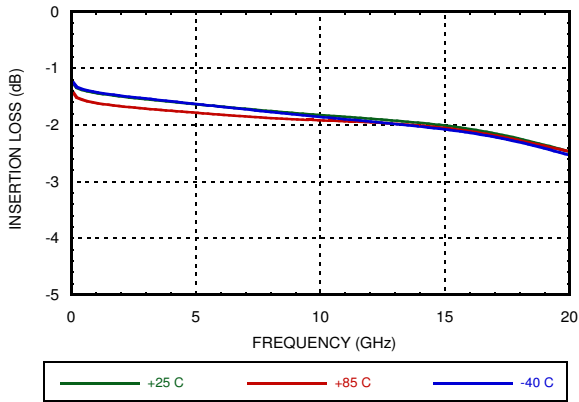

Isolation

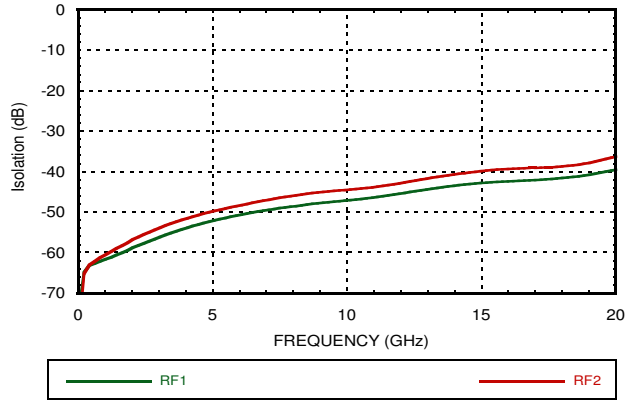

Return Loss

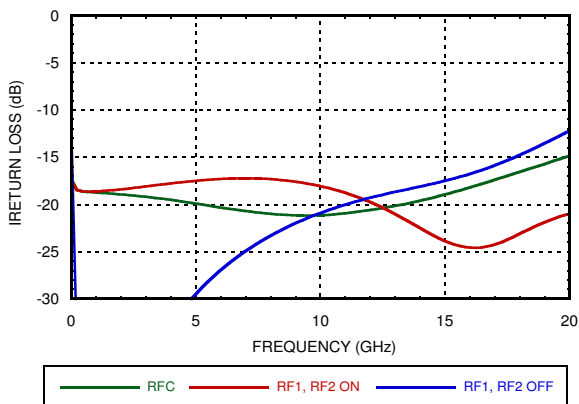

0.1 and 1 dB Input Compression Point

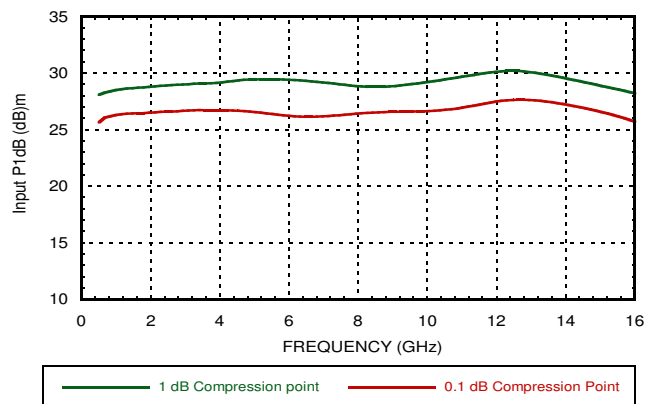

Input Third Order Intercept Point

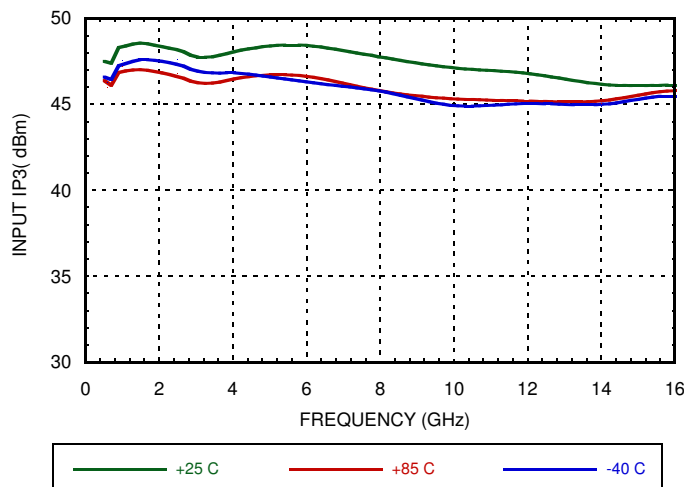

**GaAs MMIC SPDT NON-REFLECTIVE
SWITCH, DC - 14 GHz**
Absolute Maximum Ratings

RF Input Power (Vctl = -5V)	+27 dBm
Control Voltage Range (A & B)	+0.5V to -7.5 Vdc
Hot Switch Power Level (Vctl = -5 V)	+23 dBm
Channel Temperature	150 °C
Terminated Power Level (Vctl = -5V)	+25dBm
Thermal Resistance (Insertion Loss Path)	118 °C/W
Thermal Resistance (Terminated Path)	200 °C/W
Storage Temperature	-65 to +150 °C
Operating Temperature	-55 to +85 °C
ESD Sensitivity (HBM)	Class 1A

Control Voltages

State	Bias Condition
Low	0 to -0.5V @ 10 uA Max.
High	-5V @ 3uA Typ. to -7V @ 40 uA Max (± 0.5 Vdc)

Truth Table

Control Input		Signal Path State	
A	B	RFC to RF1	RFC to RF2
High	Low	On	Off
Low	High	Off	On

7

**ELECTROSTATIC SENSITIVE DEVICE
OBSERVE HANDLING PRECAUTIONS**

GaAs MMIC SPDT NON-REFLECTIVE SWITCH, DC - 14 GHz

Outline Drawing

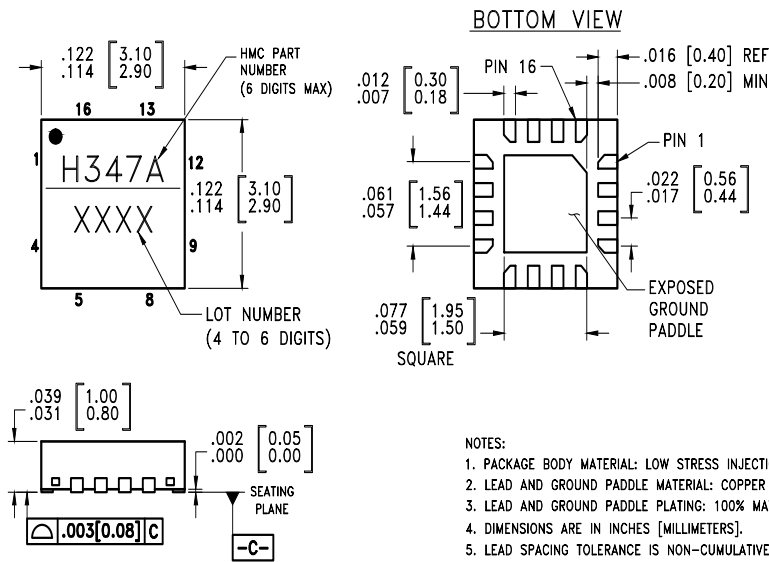

Package Information

Part Number	Package Body Material	Lead Finish	MSL Rating	Package Marking ^[2]
HMC347ALP3E	RoHS-compliant Low Stress Injection Molded Plastic	100% matte Sn	MSL3 ^[1]	<u>H347A</u> XXXX

[1] Max peak reflow temperature of 260 °C

[2] 4-Digit lot number XXXX

**GaAs MMIC SPDT NON-REFLECTIVE
SWITCH, DC - 14 GHz**

Pin Descriptions

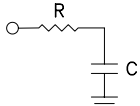
Pin Number	Function	Description	Interface Schematic
1, 5, 9, 12, 16	N/C	This pin should be connected to PCB RF ground to maximize isolation	
2, 4, 6, 8, 13, 15	GND	Package bottom has exposed metal paddle that must also be connected to PCB RF ground.	
3, 7, 14	RFC, RF1, RF2	This pin is DC coupled and matched to 50 Ohm. Blocking capacitors are required if RF line potential is not equal to 0V.	
10	CTLB	See truth table and control voltage table.	
11	CTLA	See truth table and control voltage table.	

7

SWITCHES - CHIP

Suggested Driver Circuit

