

GaAs MMIC SPDT NON-REFLECTIVE SWITCH, DC - 20 GHz

Typical Applications

The HMC547ALP3E is ideal for:

- Basestation Infrastructure
- Fiber Optics & Broadband Telecom
- Microwave Radio & VSAT
- Military Radios, Radar, & ECM
- Test Instrumentation

Features

- High Isolation: >50 dB up to 5 GHz
>40 dB up to 15 GHz
- Low Insertion Loss: 1.8 dB @ 10 GHz
2.5 dB @ 20 GHz
- Fast Switching
- Non-Reflective Design
- QFN SMT Package, 9 mm²

Functional Diagram

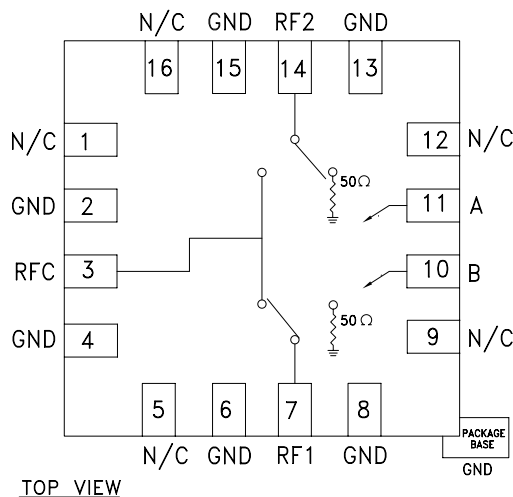

General Description

The HMC547ALP3E is a general purpose broadband high isolation non-reflective GaAs pHEMT SPDT switch in low cost leadless QFN surface mount plastic package. Covering DC to 20 GHz, the switch offers high isolation and low insertion loss. The switch features >50 dB isolation up to 5 GHz and >40 dB isolation up to 15 GHz. The switch operates using complementary negative control voltage logic lines of -5/0V and requires no bias supply. The HMC547ALP3E are packaged in leadless QFN 3x3 mm surface mount packages.

Electrical Specifications, $T_A = +25^\circ\text{C}$, With 0/-5V Control, 50 Ohm System

Parameter	Frequency	Min.	Typ.	Max.	Units
Insertion Loss	DC - 6.0 GHz		1.7	2.1	dB
	DC - 10.0 GHz		1.8	2.2	dB
	DC - 15.0 GHz		2.0	2.4	dB
	DC - 20.0 GHz		2.5	3.0	dB
Isolation	DC - 6.0 GHz	43	48		dB
	DC - 15.0 GHz	35	40		dB
	DC - 20.0 GHz	31	36		dB
Return Loss RFC	"On State"	DC - 6.0 GHz	17		dB
		DC - 20 GHz	15		dB
Return Loss RF1, RF2	"Off State"	DC - 6.0 GHz	26		dB
		DC - 15.0 GHz	17		dB
		DC - 20.0 GHz	11		dB
Input Power for 1 dB Compression	0.5 - 20.0 GHz	24	29		dBm
Input Third Order Intercept (Two-Tone Input Power= +7 dBm Each Tone)	0.5 - 10.0 GHz		47		dBm
	0.5 - 20.0 GHz		45		dBm
Switching Characteristics	DC - 20 GHz	tRISE, tFALL (10/90% RF)	2		ns
		tON, tOFF (50% CTL to 10/90% RF)	10		ns

GaAs MMIC SPDT NON-REFLECTIVE SWITCH, DC - 20 GHz

Insertion Loss

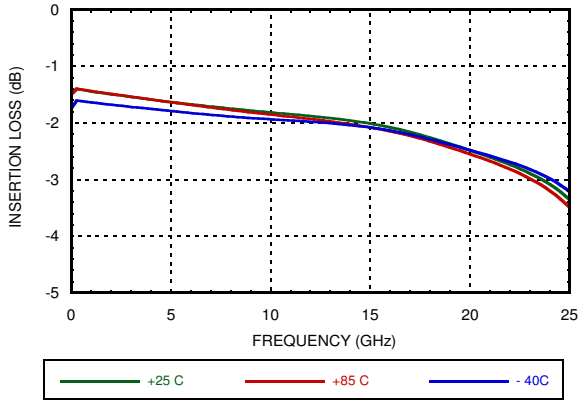

Return Loss

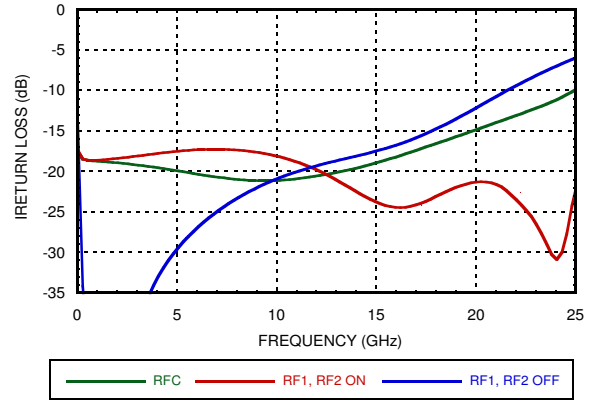

Isolation Between Ports RFC and RF1/RF2

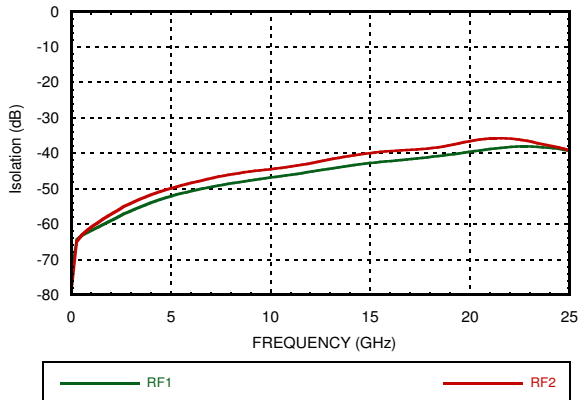

Isolation Between Ports RF1 and RF2

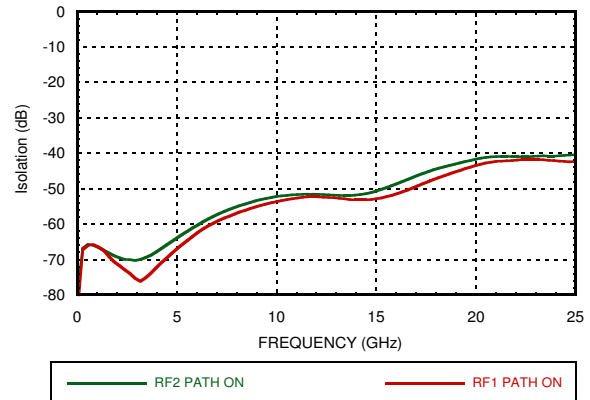

Input P1dB and P0.1dB Compression Point

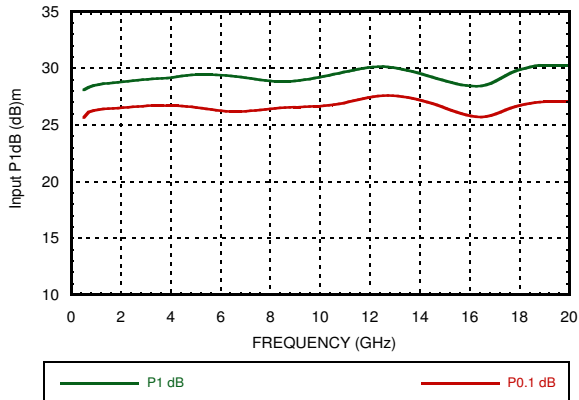

Input Third Order Intercept Point

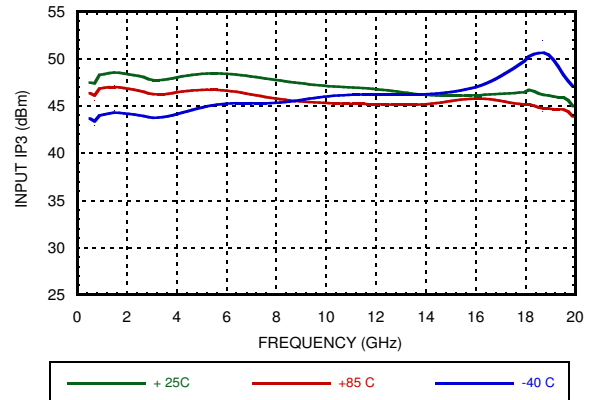

**GaAs MMIC SPDT NON-REFLECTIVE
SWITCH, DC - 20 GHz**
Absolute Maximum Ratings

RF Input Power (Vctl = -5V)	+30 dBm
Control Voltage Range (A & B)	+0.5V to -7.5 V
Hot Switch Power Level (Vctl = -5V)	+23 dBm
Channel Temperature	150 °C
Terminated Power Level (Vctl = -5V)	+25dBm
Thermal Resistance (Insertion Loss Path)	118 °C/W
Thermal Resistance (Terminated Path)	200 °C/W
Storage Temperature	-65 to +150 °C
Operating Temperature	-40 to +85 °C
ESD Sensitivity (HBM)	Class 1A

Control Voltages

State	Bias Condition
Low	0 to -0.2V @ 10 uA Max.
High	-5V @ 3uA Typ. to -7V @ 40 uA Max. (± 0.5 Vdc)

Truth Table

Control Input		Signal Path State	
A	B	RFC to RF1	RFC to RF2
High	Low	On	Off
Low	High	Off	On



**ELECTROSTATIC SENSITIVE DEVICE
OBSERVE HANDLING PRECAUTIONS**

GaAs MMIC SPDT NON-REFLECTIVE SWITCH, DC - 20 GHz

Outline Drawing

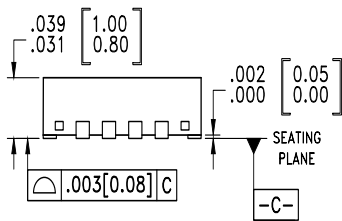
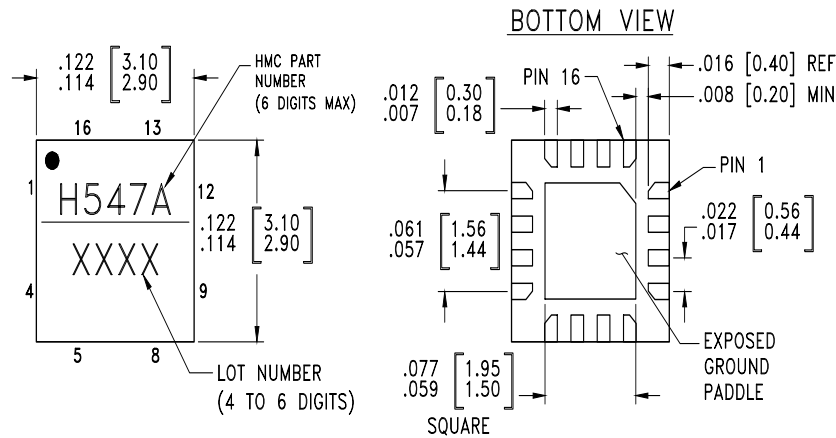

NOTES:

1. PACKAGE BODY MATERIAL: LOW STRESS INJECTION MOLDED PLASTIC SILICA AND SILICON IMPREGNATED.
2. LEAD AND GROUND PADDLE MATERIAL: COPPER ALLOY.
3. LEAD AND GROUND PADDLE PLATING: 100% MATTE TIN.
4. DIMENSIONS ARE IN INCHES [MILLIMETERS].
5. LEAD SPACING TOLERANCE IS NON-CUMULATIVE.
6. CHARACTERS TO BE HELVETICA MEDIUM, .018 HIGH, WHITE INK, OR LASER MARK LOCATED APPROX. AS SHOWN.
7. PAD BURR LENGTH SHALL BE 0.15mm MAX. PAD BURR HEIGHT SHALL BE 0.05mm MAX.
8. PACKAGE WARP SHALL NOT EXCEED 0.05mm
9. ALL GROUND LEADS AND GROUND PADDLE MUST BE SOLDERED TO PCB RF GROUND.
10. REFER TO HITITTE APPLICATION NOTE FOR SUGGESTED PCB LAND PATTERN.
11. UNDERLINE THE LOT NUMBER TO DESIGNATE 2000A FIRST LAYER NITRIDE DIE FAB OPTION AS SPECIFIED BY THE PO

Package Information

Part Number	Package Body Material	Lead Finish	MSL Rating	Package Marking ^[2]
HMC547ALP3E	RoHS-compliant Low Stress Injection Molded Plastic	100% matte Sn	MSL3 ^[1]	H547A XXXX

[1] Max peak reflow temperature of 260 °C

[2] 4-Digit lot number XXXX

GaAs MMIC SPDT NON-REFLECTIVE SWITCH, DC - 20 GHz

Pin Descriptions

Pin Number	Function	Description	Interface Schematic
1, 5, 9, 12, 16	N/C	This pin should be connected to PCB RF ground to maximize isolation	
2, 4, 6, 8, 13, 15	GND	Package bottom has exposed metal paddle that must also be connected to PCB RF ground.	
3, 7, 14	RFC, RF1, RF2	This pin is DC coupled and matched to 50 Ohm. Blocking capacitors are required if RF line potential is not equal to 0V.	
10	B	See truth table and control voltage table.	
11	A	See truth table and control voltage table.	

Suggested Driver Circuit

