

Surface Mount Bandpass Filter

SYBP-2250+

50Ω 1880 to 2620 MHz



CASE STYLE: TT1423

Features

- High power handling
- Small size
- Temperature stable
- Excellent rejection

Applications

- Military radio
- PCS
- Satellite
- UMTS
- WiFi
- Lab use

Electrical Specifications at 25°C

Parameter	F#	Frequency (MHz)	Min.	Typ.	Max.	Unit	
Pass Band	Center Frequency	—	—	2250	—	MHz	
	Insertion Loss	F1-F2	1880 - 2620	—	2.2	3.0	dB
	VSWR	F1-F2	1880 - 2620	—	1.5	1.9	:1
Stop Band, Lower	Insertion Loss	DC-F3	DC - 1280	20	25	—	dB
	VSWR	DC-F3	DC - 1280	—	15	—	:1
Stop Band, Upper	Insertion Loss	F4-F5	3640 - 5400	20	30	—	dB
	VSWR	F4-F5	3640 - 5400	—	10	—	:1

Maximum Ratings

Operating Temperature	-40°C to 85°C
Storage Temperature	-55°C to 100°C
RF Power Input	7W* max. at 25°C

*Passband rating, derate linearly to 3W at 85°C ambient
Permanent damage may occur if any of these limits are exceeded.

Functional Schematic

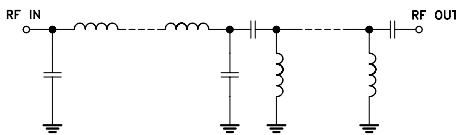

Typical Frequency Response

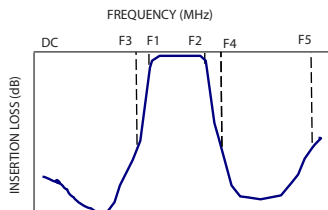

+RoHS Compliant

The +Suffix identifies RoHS Compliance. See our web site for RoHS Compliance methodologies and qualifications

Typical Performance Data at 25°C

Frequency (MHz)	Insertion Loss (dB)	VSWR (:1)
10.00	75.60	9598.53
600.00	42.56	24.93
1000.00	36.86	19.31
1100.00	36.69	18.57
1280.00	25.98	14.78
1380.00	16.27	10.40
1500.00	6.63	4.40
1880.00	1.36	1.33
2000.00	1.24	1.24
2400.00	1.46	1.41
2620.00	1.79	1.53
3000.00	5.96	5.98
3640.00	29.39	11.65
4280.00	29.65	10.55
5400.00	23.11	15.53

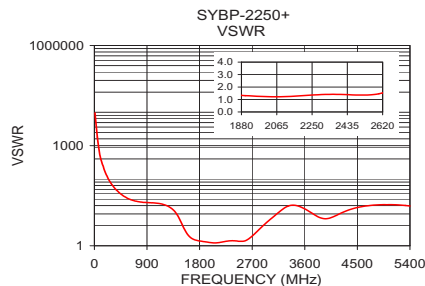
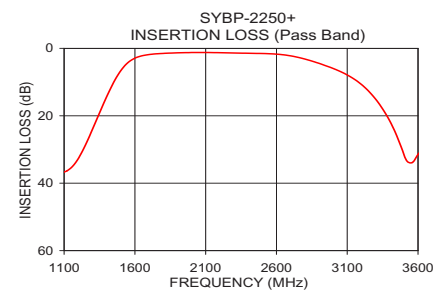
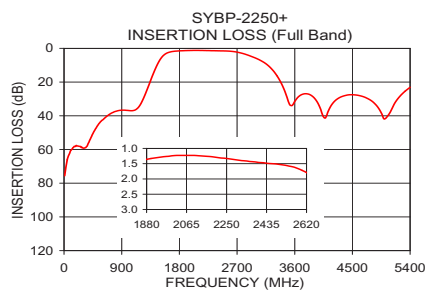

Notes

- Performance and quality attributes and conditions not expressly stated in this specification document are intended to be excluded and do not form a part of this specification document.
- Electrical specifications and performance data contained in this specification document are based on Mini-Circuit's applicable established test performance criteria and measurement instructions.
- The parts covered by this specification document are subject to Mini-Circuits standard limited warranty and terms and conditions (collectively, "Standard Terms"); Purchasers of this part are entitled to the rights and benefits contained therein. For a full statement of the Standard Terms and the exclusive rights and remedies thereunder, please visit Mini-Circuits' website at www.minicircuits.com/MCLStore/terms.jsp





Pin Connections

RF IN	4
RF OUT	6
GROUND	1,2,3,5

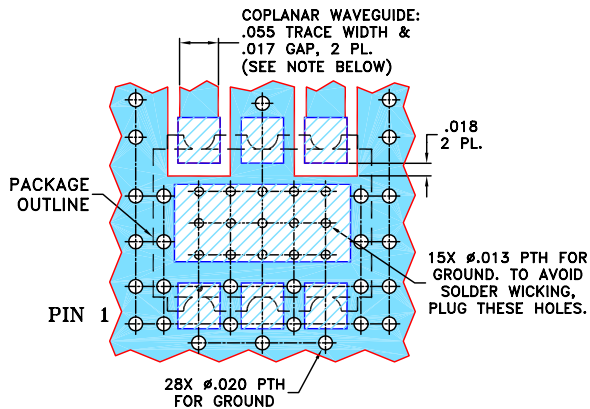
Demo Board MCL P/N: TB-517+
Suggested PCB Layout (PL-308)



NOTES:

- COPLANAR WAVEGUIDE PARAMETERS ARE SHOWN FOR ROGERS R04350B WITH THICKNESS $.030 \pm .002$; COPPER: 1/2 OZ. EACH SIDE. FOR OTHER MATERIALS TRACE WIDTH AND GAP MAY NEED TO BE MODIFIED.
 - BOTTOM SIDE OF THE PCB IS CONTINUOUS GROUND PLANE.
-  DENOTES PCB COPPER LAYOUT WITH SMOBC (SOLDER MASK OVER BARE COPPER)
-  DENOTES COPPER LAND PATTERN FREE OF SOLDER MASK

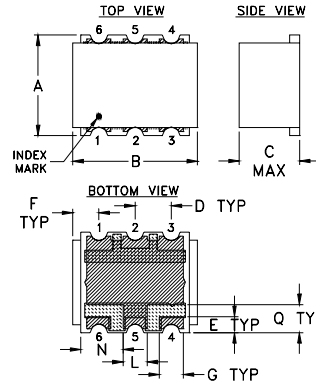

Outline Drawing

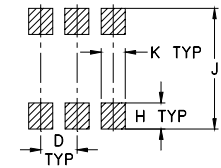

PCB Land Pattern



Suggested Layout,
Tolerance to be within $\pm .002$

-  METALLIZATION
-  SOLDER RESIST

Outline Dimensions (inch)

A	B	C	D	E	F	G	H
.25	.31	.15	.090	.040	.065	.060	.065
6.35	7.87	3.81	2.29	1.02	1.65	1.52	1.65
J	K	L	N	Q	wt.		
.300	.060	.060	.105	.070	grams		
7.62	1.52	1.52	2.67	1.78	0.50		

Notes

- A. Performance and quality attributes and conditions not expressly stated in this specification document are intended to be excluded and do not form a part of this specification document.
- B. Electrical specifications and performance data contained in this specification document are based on Mini-Circuit's applicable established test performance criteria and measurement instructions.
- C. The parts covered by this specification document are subject to Mini-Circuits standard limited warranty and terms and conditions (collectively, "Standard Terms"); Purchasers of this part are entitled to the rights and benefits contained therein. For a full statement of the Standard Terms and the exclusive rights and remedies thereunder, please visit Mini-Circuits' website at www.minicircuits.com/MCLStore/terms.jsp