

High Power Bi-Directional Coupler

SYBD-16-53HP+

50Ω 16dB Coupling DC Pass 2700 to 5000 MHz



Generic photo used for illustration purposes only

CASE STYLE: JB1233

+RoHS Compliant

The +Suffix identifies RoHS Compliance. See our web site for RoHS Compliance methodologies and qualifications

Maximum Ratings

Operating Temperature	-55°C to 100°C
Storage Temperature	-55°C to 100°C
DC Current	2A

Permanent damage may occur if any of these limits are exceeded.

Pin Connections

INPUT	1
OUTPUT	2
COUPLED (forward)	4
COUPLED (reverse)	3
GROUND	5

Outline Drawing

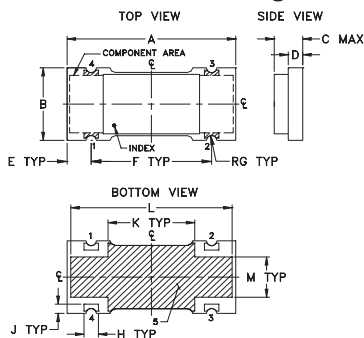

PCB Land Pattern

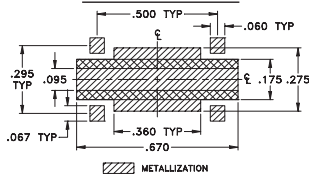

Suggested Layout,
Tolerance to be within ±.002

Outline Dimensions (inch/mm)

A	B	C	D	E	F	G
.70	.32	.13	.060	.100	.500	.022
17.78	8.13	3.30	1.52	2.54	12.70	0.56
H	J	K	L	M	wt	
.060	.040	.360	.670	.175	grams	
1.52	1.02	9.14	17.02	4.45	0.68	

Demo Board MCL P/N: TB-398 Suggested PCB Layout (PL-260)

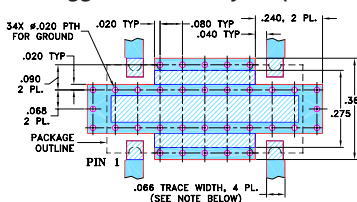

- NOTES: 1. TRACE WIDTH IS SHOWN FOR ROGERS RO4350B WITH DIELECTRIC THICKNESS .030" ± .002"; COPPER: 1/2 OZ. EACH SIDE. FOR OTHER MATERIALS TRACE WIDTH MAY NEED TO BE MODIFIED.
2. BOTTOM SIDE OF THE PCB IS CONTINUOUS GROUND PLANE.
3. DENOTES PCB COPPER LAYOUT WITH SMOBC (SOLDER MASK OVER BARE COPPER)
4. DENOTES COPPER LAND PATTERN FREE OF SOLDER MASK

Notes

- A. Performance and quality attributes and conditions not expressly stated in this specification document are intended to be excluded and do not form a part of this specification document.
B. Electrical specifications and performance data contained in this specification document are based on Mini-Circuit's applicable established test performance criteria and measurement instructions.
C. The parts covered by this specification document are subject to Mini-Circuit's standard limited warranty and terms and conditions (collectively, "Standard Terms"); Purchasers of this part are entitled to the rights and benefits contained therein. For a full statement of the Standard Terms and the exclusive rights and remedies thereunder, please visit Mini-Circuit's website at www.minicircuits.com/WCLStore/terms.jsp

Features

- high power handling, 25 watts typ.
- low mainline loss, 0.2 dB typ.
- excellent VSWR, 1.2:1 typ.
- good directivity 20 dB typ.
- wideband frequency, 2700 to 5000 MHz

Applications

- instrumentation
- ISM
- defense communications
- federal communications
- fixed satellite

Bi-Directional Coupler Electrical Specifications

FREQ. (MHz)	COUPLING (dB)		MAINLINE LOSS ¹ (dB)		DIRECTIVITY (dB)		VSWR (:1)	POWER INPUT (W)
	Nom.	Flatness	Typ.	Max.	Typ.	Min.		
f_L - f_U								
2700-5000			0.20	0.70	18	10	1.20	
2700-3000	18.1±0.8	±0.5	0.12	0.40	20	13	1.15	25
3000-3600	17.4±0.8	±0.7	0.15	0.45	18	13	1.15	25
3600-4500	16.3±0.7	±0.7	0.20	0.60	16	11	1.25	20
4500-5000	16.0±0.7	±0.4	0.24	0.70	15	10	1.30	20

1. Mainline loss includes theoretical power loss at coupled port.

Typical Performance Data

Frequency (MHz)	Mainline Loss (dB)	Coupling (dB)		Directivity (dB)		Return Loss (dB)			
		In-Out	In-Cpl Fwd	Out-Cpl Rev	Out-Cpl Fwd	In-Cpl Rev	In	Out	Cpl Fwd
2700.00	0.12	18.87	18.56	20.62	20.02	24.50	25.16	27.41	27.68
3000.00	0.12	17.99	17.98	20.06	19.20	24.97	25.28	24.97	25.23
3400.00	0.15	17.27	17.29	18.87	17.96	27.86	26.90	23.35	22.99
3600.00	0.16	16.91	17.01	18.20	17.23	31.91	30.03	23.99	23.80
3800.00	0.17	16.66	16.70	17.69	16.80	41.81	36.07	25.52	25.46
4000.00	0.17	16.44	16.44	16.92	16.36	37.46	38.04	28.89	28.82
4200.00	0.18	16.27	16.24	16.62	16.21	31.72	31.57	34.93	36.47
4500.00	0.20	16.08	16.05	16.76	16.62	28.61	27.86	34.67	36.13
4800.00	0.23	15.93	15.91	17.53	17.49	27.69	26.78	28.61	28.44
5000.00	0.24	15.90	15.87	17.58	17.84	27.32	26.23	26.99	26.29

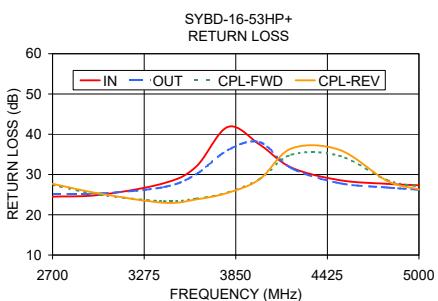
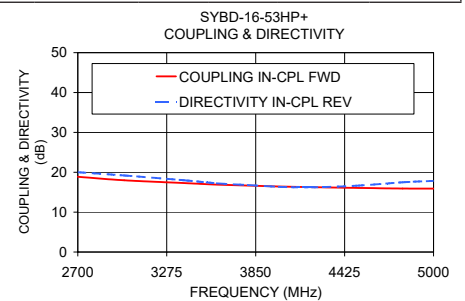
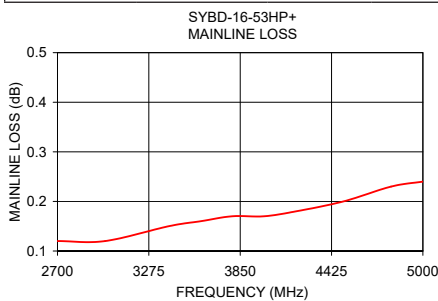

Electrical Schematic

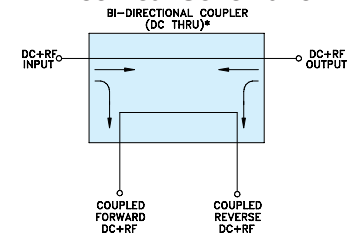

* ELECTRICAL SCHEMATIC IS FOR BI-DIRECTIONAL COUPLER WITHOUT INTERNAL TRANSFORMERS AND RESISTORS.



www.minicircuits.com P.O. Box 350166, Brooklyn, NY 11235-0003 (718) 934-4500 sales@minicircuits.com

REV. C
M151107
ED-12832/1
SYBD-16-53HP+
WZ/QL/AM
200811