

Product Overview

The CMD279C3 is a positive controlled, wideband GaAs MMIC 5-bit digital attenuator housed in a leadless 3x3 mm surface mount package. Each bit of the attenuator is controlled by a single voltage of either 0 V or +5 V. The attenuator bit values are 0.5 (LSB), 1, 2, 4, and 8 dB, for a total attenuation of 15.5 dB. The CMD279C3 has a low insertion loss of 3.5 at 9 GHz and the attenuation accuracy is typically 0.2 dB step error. The CMD279C3 is a 50 ohm matched design which eliminates the need for RF port matching

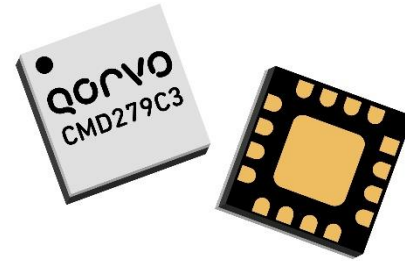

Functional Block Diagram

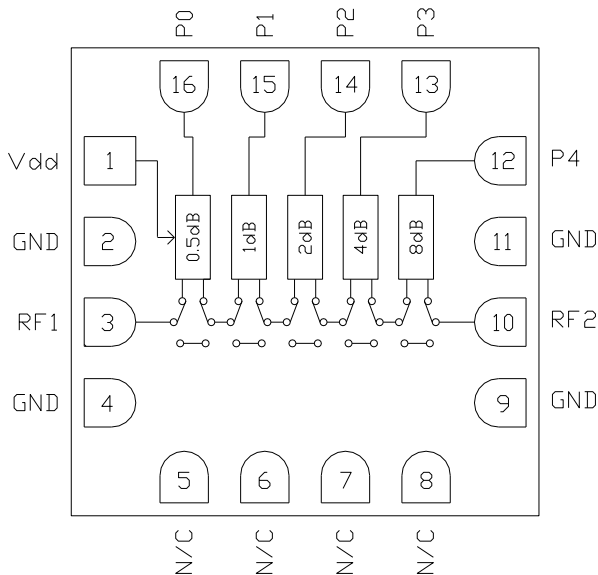

Key Features

- Wideband Performance
- Low Insertion Loss
- Wide Attenuation Range
- Pb-Free RoHs Compliant 3x3 QFN Package

Ordering Information

Part No.	Description
CMD279C3	100pcs on 7" reel
CMD279C3-EVB	Evaluation Board

Electrical Performance ($V_{dd} = 5\text{ V}$, $V_{ctl} = 0 / +5\text{ V}$, $T_A = 25^\circ\text{ C}$, $F = 9\text{ GHz}$)

Parameter	Min	Typ	Max	Units
Frequency Range		2 - 18		GHz
Insertion Loss		3.5		dB
Attenuation Range		15.5		dB
Input Return Loss		13		dB
Output Return Loss		13		dB
Input P0.1dB		27		dBm
Input IP3		42		dBm
Switching Speed		25		ns

Absolute Maximum Ratings

Parameter	Rating
Bias Voltage, V_{dd}	8 V
Control Voltage, V_{ctl}	8 V
RF Input Power	+27 dBm
Thermal Resistance, Q_{JC}	115.28° C/W
Operating Temperature	-40 to 85° C
Storage Temperature	-55 to 150° C

Exceeding any one or combination of the maximum ratings may cause permanent damage to the device.

Recommended Operating Conditions

Parameter	Min	Typ	Max	Units
V_{dd}	2.5	5	5.5	V

Electrical performance is measured at specific test conditions. Electrical specifications are not guaranteed over all recommended operating conditions.

Truth Table

Control Voltage Input					Attenuation State RF1 - RF2 (dB)
P0 0.5 dB	P1 1 dB	P2 2 dB	P3 4 dB	P4 8 dB	
High	High	High	High	High	Reference (insertion loss)
Low	High	High	High	High	0.5
High	Low	High	High	High	1.0
High	High	Low	High	High	2.0
High	High	High	Low	High	4.0
High	High	High	High	Low	8.0
Low	Low	Low	Low	Low	15.5

Any combination of the above states will result in an attenuation approximately equal to the sum of the bits selected.

Control Voltage

State	Bias Condition
High	$V_{dd} \pm 0.3$ V
Low	0 ± 0.3 V

Electrical Specifications ($V_{dd} = +5$ V, $V_{ctl} = 0/+5$ V, $T_A = 25^\circ$ C)

Parameter	Min	Typ	Max	Min	Typ	Max	Units
Frequency Range		2 - 10		10 - 18			GHz
Insertion Loss		3.2	4.3		4.2	5	dB
Attenuation Range		15.5		15.5			dB
Attenuation Accuracy 0.5 - 7.5 dB States 8 - 15.5 dB States		± 0.4 Max $\pm 0.6 + 10\%$ of Atten. Setting Max		± 0.4 Max $\pm 0.6 + 10\%$ of Atten. Setting Max			dB dB
Input Return Loss		13		13			dB
Output Return Loss		13		13			dB
Input P0.1 dB		26.5		26.5			dBm
Input IP3		42		42			dBm

Note: Specification applies to major states

Typical Performance

Insertion Loss versus Temperature

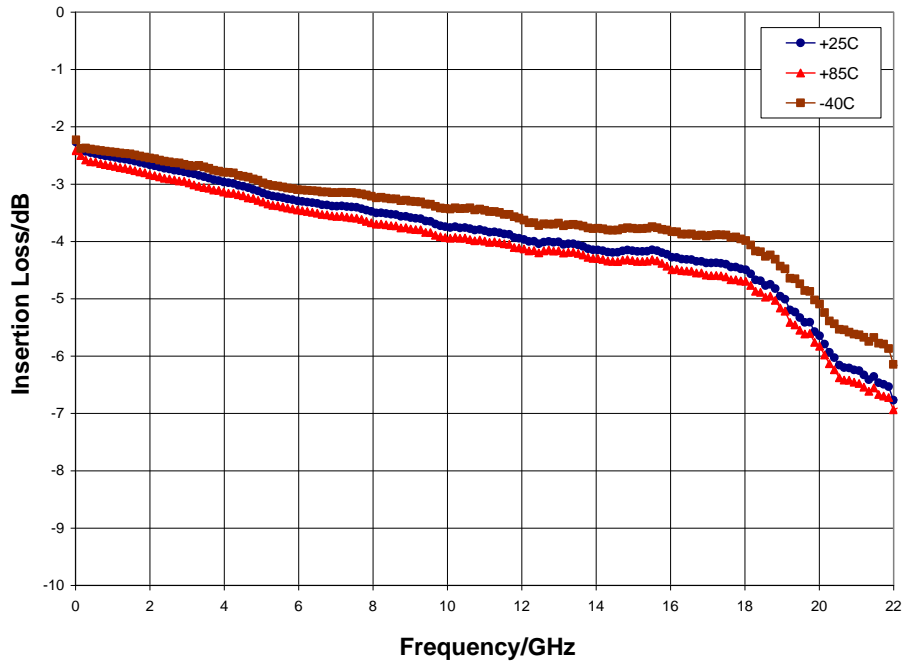

Normalized Attenuation (major states only), T_A = 25° C

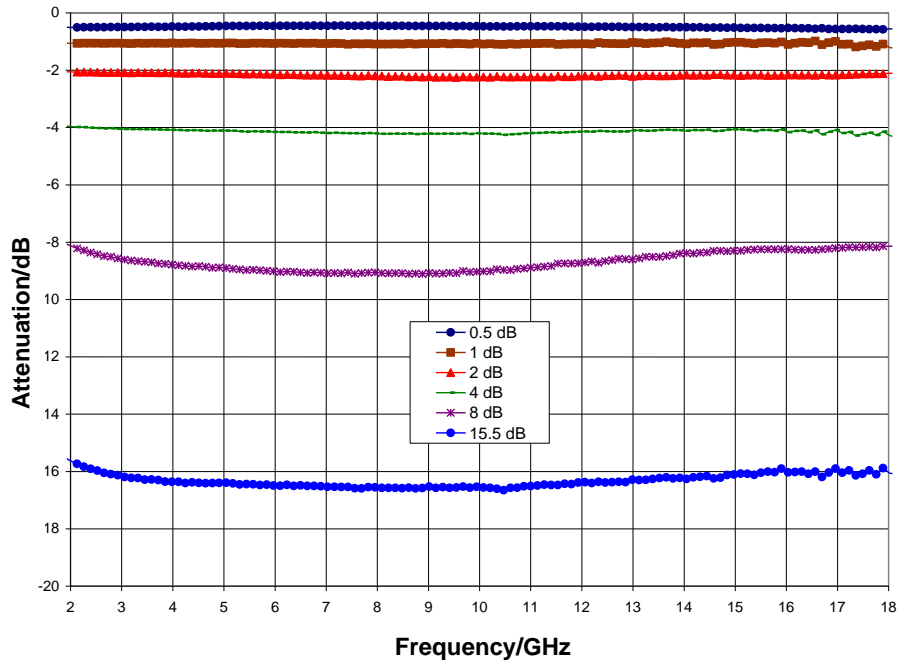

Typical Performance

Input Return Loss (major states only), $T_A = 25^\circ\text{C}$

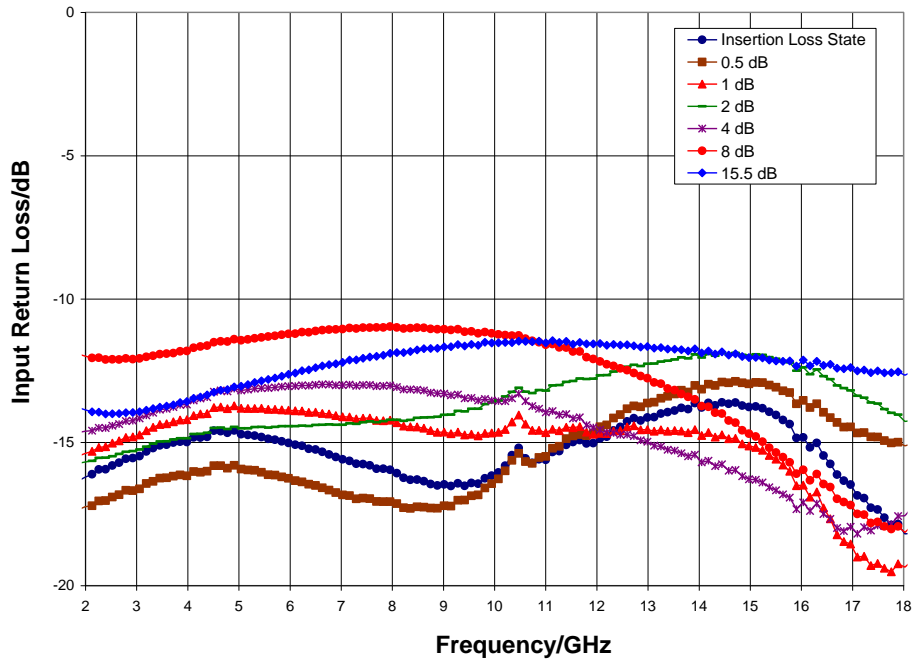

Output Return Loss (major states only), $T_A = 25^\circ\text{C}$

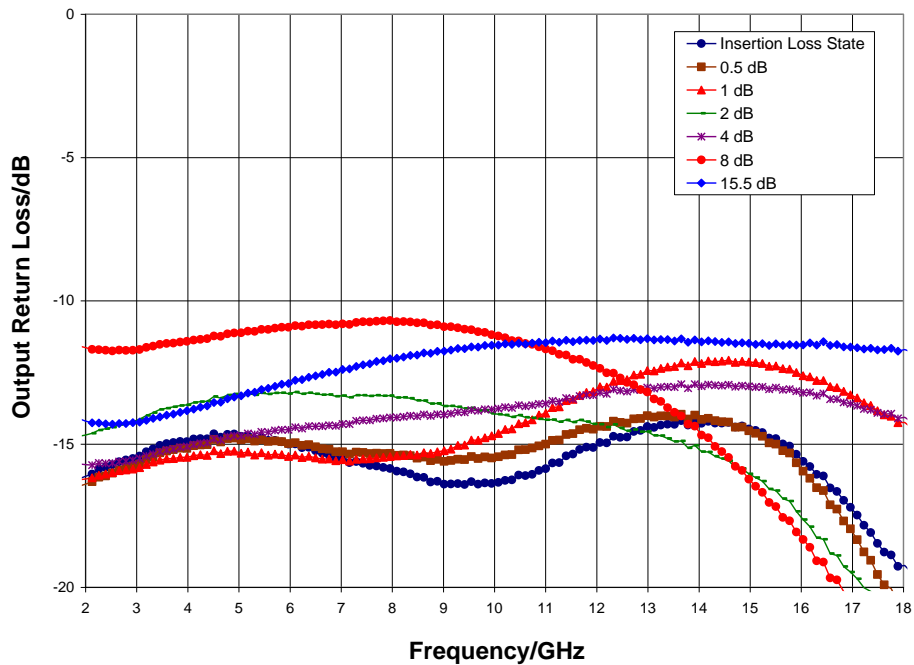

Typical Performance

Bit Error versus Frequency, $T_A = 25^\circ\text{C}$

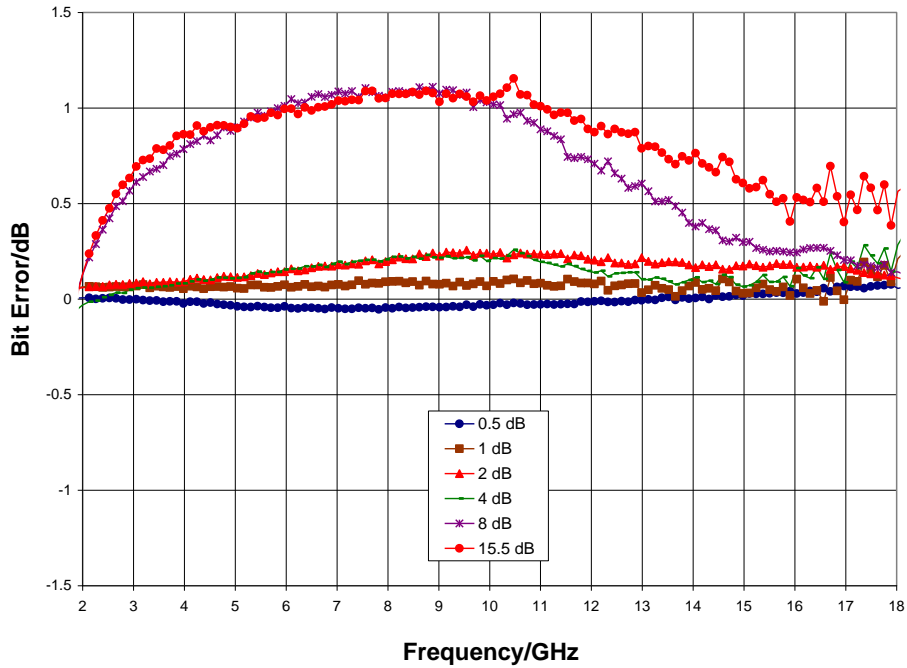

Relative Phase versus Frequency, $T_A = 25^\circ\text{C}$

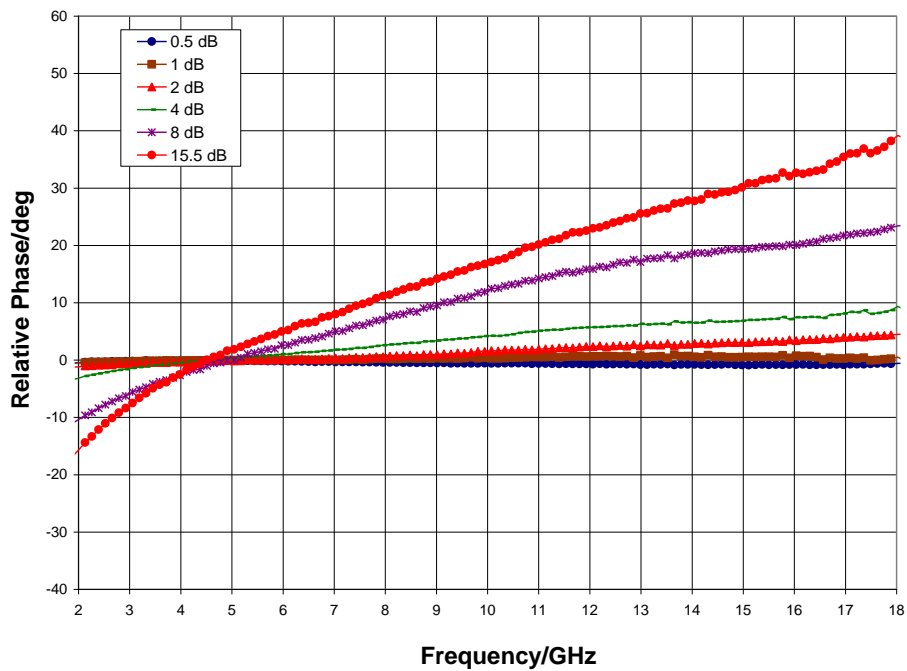

Typical Performance

Step Attenuation versus Attenuation State, $T_A = 25^\circ\text{C}$

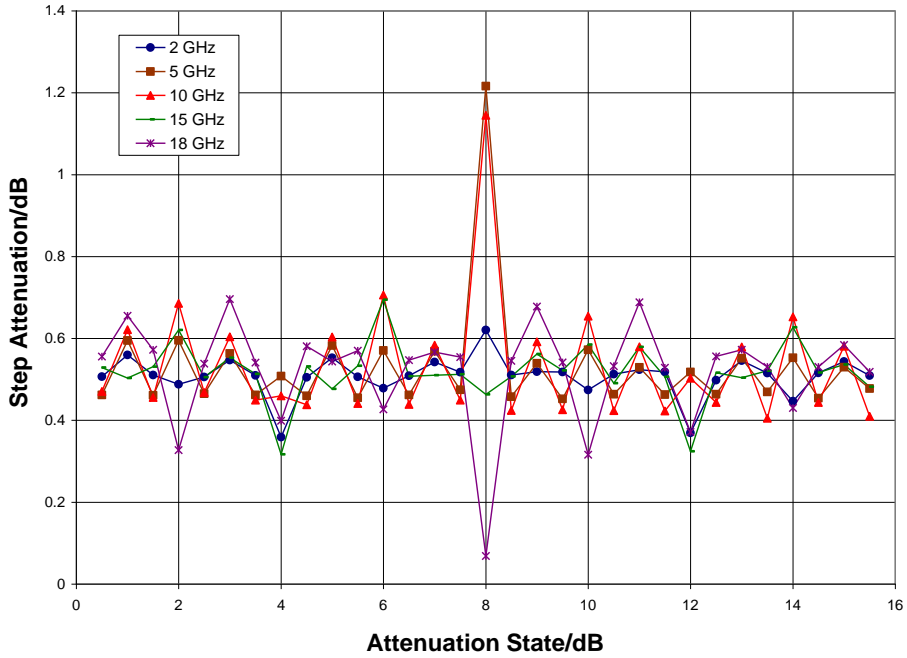

Input Power for 0.1 dB Compression (insertion loss state)

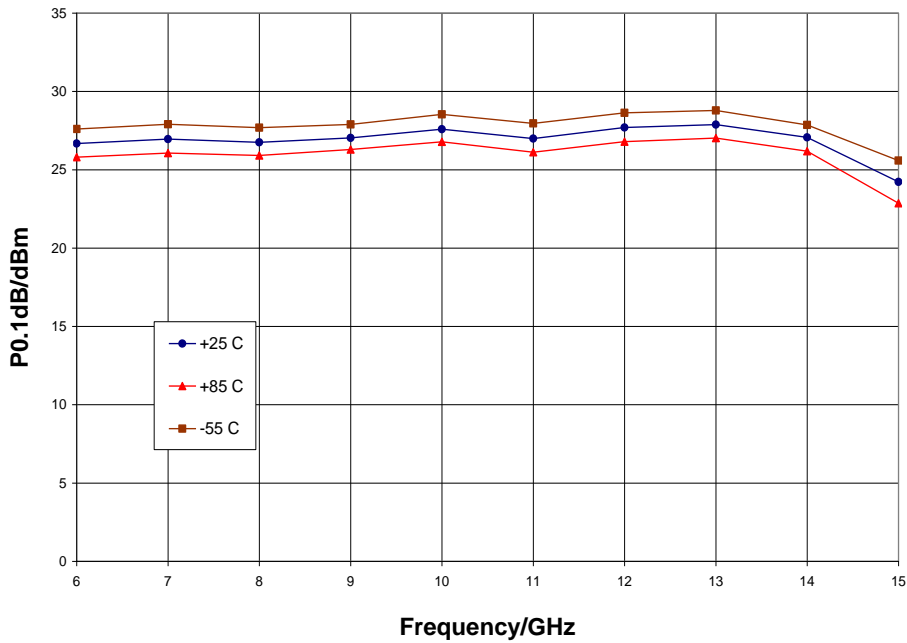

Typical Performance

Input IP3 versus Temperature (insertion loss state)

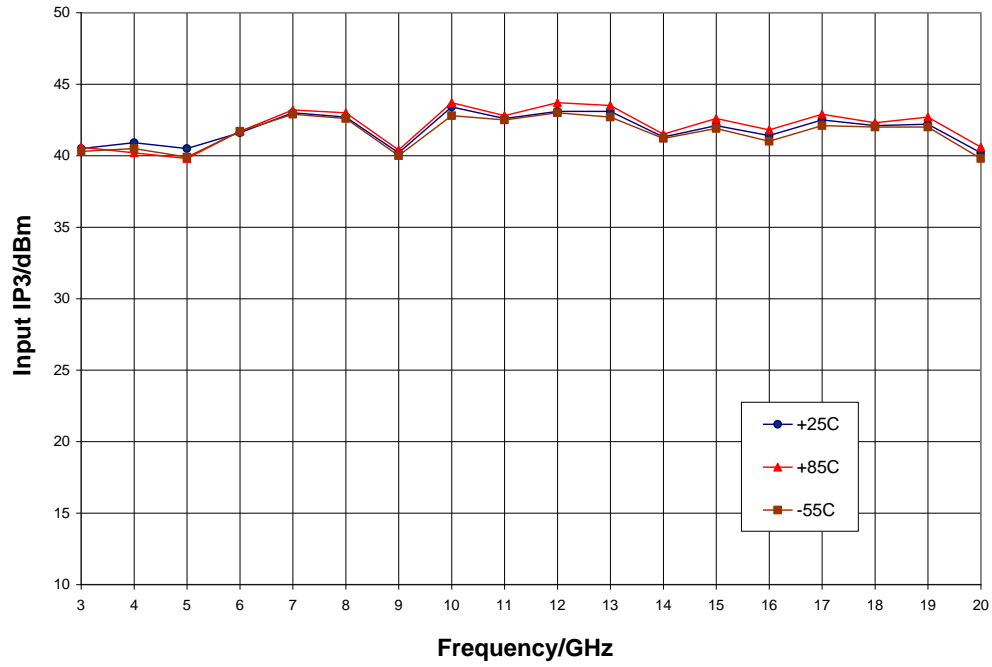

Mechanical Information

Package Information and Dimensions

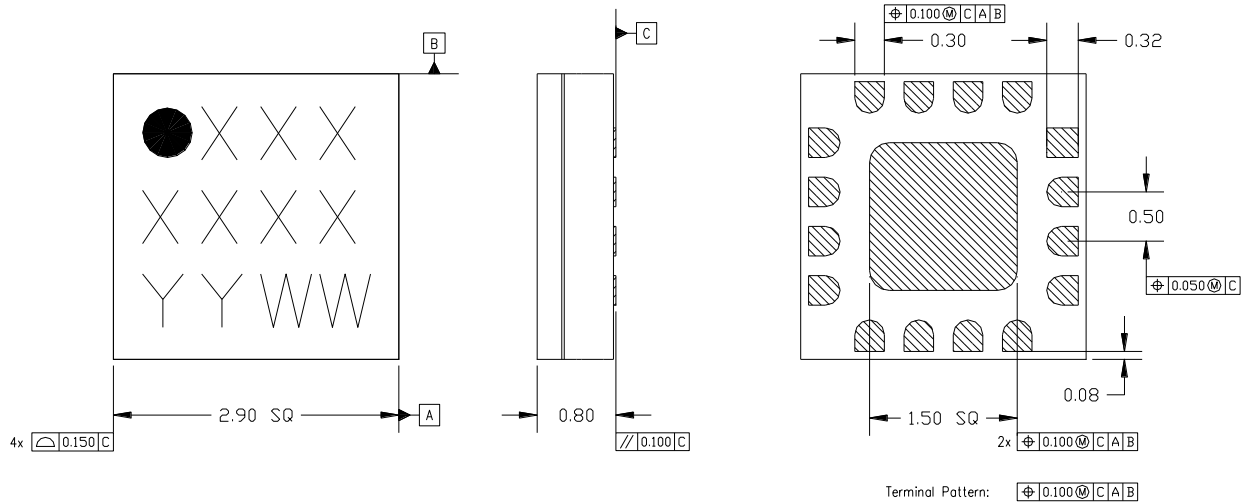

Notes:

1. All dimensions shown in mm.
2. Material: Black alumina
3. Lead finish:
 - 3.1. Ni: 8.89 μ m max 1.27 μ m min
 - 3.2. Pd: 0.17 μ m max, 0.07 μ m min
 - 3.3. Au: 0.254 μ m max, 0.03 μ m min
4. Marking
 - 4.1. Line 1: Part number
 - 4.1.1. Example: CMD196C3 shall be marked as 196
 - 4.2. Line 2: Lot number
 - 4.3. Line 3: Date code - Last 2 digits of the year of manufacture followed by a 2 digit week code
5. Alternate pin #1 identifier is a single square pad
6. Alternate die paddle may have chamfered corners

Recommended PCB Land Pattern

Qorvo recommends that the user develop the land pattern that will provide the best design for proper solder reflow and device attach for their specific application. Please review Qorvo Application Note AN 105 for a recommended land pattern approach.

Recommended Solder Reflow Profile

Qorvo recommends screen printing with belt furnace reflow to ensure proper solder reflow and device attach. Please review Qorvo Application Note AN 102 for a recommended solder reflow profile.

Pin Description

Pin Diagram

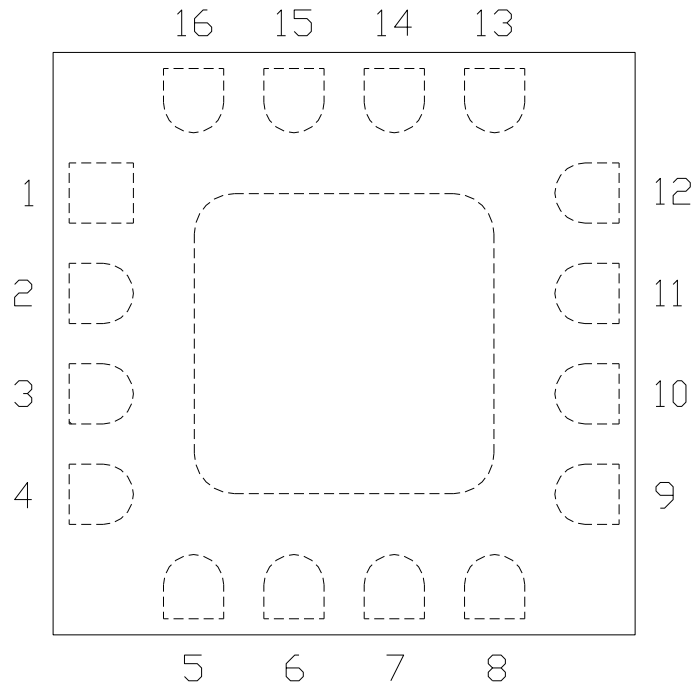

Functional Description

Pin	Function	Description	Schematic
1	V _{dd}	Positive bias +5 V	
2, 4, 9, 11 and die paddle	Ground	Connect to RF / DC ground	
3, 10	RF1, RF2	DC coupled, 50 ohm matched External blocking capacitors are required	
5 - 8	N/C	No connection required These pins may be connected to RF / DC ground	
12 - 16	P4 - P0	Bit control voltages, see truth table for values	

Applications Information

Evaluation Board

The circuit board shown has been developed for optimized assembly at Qorvo. A sufficient number of via holes should be used to connect the top and bottom ground planes. As surface mount processes vary, careful process development is recommended.

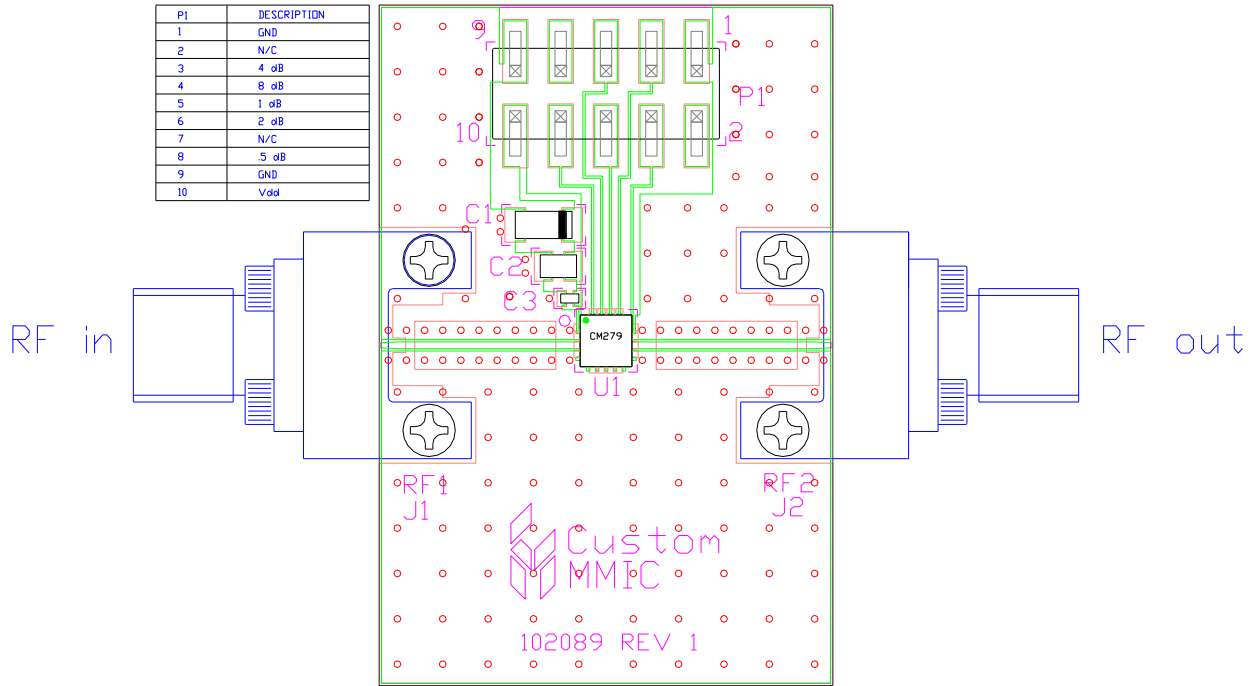

Designator	Value	Description
J1, J2		SMA End Launch Connector
P1		10 Pin Header
C1	0.33 μ F	Capacitor, Tantalum
C2	1000 pF	Capacitor, 0603
C3	100 pF	Capacitor, 0402
U1		CMD279C3 DATT
PCB		102089 Evaluation PCB

GaAs MMIC devices are susceptible to damage from Electrostatic Discharge. Proper precautions should be observed during handling, assembly and test.

Handling Precautions

Parameter	Rating	Standard
ESD – Human Body Model (HBM)	Class 1A	ESDA / JEDEC JS-001-2012
MSL – Moisture Sensitivity Level	Level 1	IPC/JEDEC J-STD-020



Caution!
ESD-Sensitive Device

RoHS Compliance

This part is compliant with 2011/65/EU RoHS directive (Restrictions on the Use of Certain Hazardous Substances in Electrical and Electronic Equipment) as amended by Directive 2015/863/EU.

This product also has the following attributes:

- Lead Free
- Antimony Free
- TBBP-A (C₁₅H₁₂Br₄O₂) Free
- SVHC Free
- PFOS Free
- Halogen Free



Contact Information

For the latest specifications, additional product information, worldwide sales and distribution locations:

Web: www.qorvo.com

Tel: 1-844-890-8163

Email: customer.support@qorvo.com

Important Notice

The information contained in this Data Sheet and any associated documents (“Data Sheet Information”) is believed to be reliable; however, Qorvo makes no warranties regarding the Data Sheet Information and assumes no responsibility or liability whatsoever for the use of said information. All Data Sheet Information is subject to change without notice. Customers should obtain and verify the latest relevant Data Sheet Information before placing orders for Qorvo® products. Data Sheet Information or the use thereof does not grant, explicitly, implicitly or otherwise any rights or licenses to any third party with respect to patents or any other intellectual property whether with regard to such Data Sheet Information itself or anything described by such information.

DATA SHEET INFORMATION DOES NOT CONSTITUTE A WARRANTY WITH RESPECT TO THE PRODUCTS DESCRIBED HEREIN, AND QORVO HEREBY DISCLAIMS ANY AND ALL WARRANTIES WITH RESPECT TO SUCH PRODUCTS WHETHER EXPRESS OR IMPLIED BY LAW, COURSE OF DEALING, COURSE OF PERFORMANCE, USAGE OF TRADE OR OTHERWISE, INCLUDING THE IMPLIED WARRANTIES OF MERCHANTABILITY AND FITNESS FOR A PARTICULAR PURPOSE. Without limiting the generality of the foregoing, Qorvo® products are not warranted or authorized for use as critical components in medical, life-saving, or life-sustaining applications, or other applications where a failure would reasonably be expected to cause severe personal injury or death. Applications described in the Data Sheet Information are for illustrative purposes only. Customers are responsible for validating that a particular product described in the Data Sheet Information is suitable for use in a particular application.

© 2020 Qorvo US, Inc. All rights reserved. This document is subject to copyright laws in various jurisdictions worldwide and may not be reproduced or distributed, in whole or in part, without the express written consent of Qorvo US, Inc. | QORVO® is a registered trademark of Qorvo US, Inc.