

**NEW!**

MMIC

# REFLECTIONLESS FILTERS

50Ω DC to 21 GHz

## The Big Deal

- Patented design eliminates in band spurs
- Pass band cut-off up to 21 GHz
- Stop band up to 35 GHz
- Excellent repeatability through IPD\* process



**X-Series**

Available in Low Pass, High Pass and Band Pass designs

## Product Overview

Mini-Circuits' **X-Series** reflectionless filters employ a novel filter topology which absorbs and terminates stop band signals internally rather than reflecting them back to the source. This new capability enables unique applications for filter circuits beyond those suited to traditional approaches. Traditional filters are reflective in the stop band, sending signals back to the source at 100% of the power level which interact with neighboring components and often result in intermodulation and other interferences. Reflectionless filters eliminate stop band reflections, allowing them to be paired with sensitive devices and used in applications that otherwise require circuits such as isolation amplifiers or attenuators.

### Key Features

### Advantages

Easy integration with sensitive reflective components, e.g. mixers, multipliers	Reflectionless filters absorb unwanted signals, preventing reflections back to the source. This reduces generation of additional unwanted signals without the need for extra components like attenuators, improving system dynamic range and saving board space.
Enables stable integration of wideband amplifiers	Because reflectionless filters maintain good impedance in the stop band; they can be integrated with high gain, wideband amplifiers without the risk of creating instabilities in these out of band regions.
Cascadable	Reflectionless filters can be cascaded in multiple sections to provide sharper and higher attenuation, while also preventing any standing waves that could affect pass band signals.
Excellent power handling in a tiny surface mount device	High power handling extends the usability of these filters to the transmit path for inter-stage filtering.
Small size, 3x3mm QFN	Allows replacement of filter/attenuator pairs with a single reflectionless filter, saving board space.
Excellent repeatability of RF performance	Through semiconductor IPD process, X-series filters are inherently repeatable for large volume production.
Excellent stability over temperature	With $\pm 0.3$ dB variation over temperature ideal for use in wide temperature range applications without the need for additional temperature compensation.
Operating temperature up to 105°C	Suitable for operation close to high power components.

\*IPD – Integrated Passive Device, is a GaAs semiconductor process



# Reflectionless High Pass Filter

## XHF-73M+

50Ω 7000 to 16400 MHz

### Features

- Match to 50Ω in the stop band, eliminates undesired reflections
- Cascadable
- Excellent Power handling
- Temperature stable, up to 105°C
- Small size, 3 x 3 mm
- Protected by US Patents 8,392,495; 9,705,467, additional patent pending
- Protected by China Patent 201080014266.1
- Protected by Taiwan Patent I581494



Generic photo used for illustration purposes only

CASE STYLE: DQ1225

### +RoHS Compliant

The +Suffix identifies RoHS Compliance. See our web site for RoHS Compliance methodologies and qualifications



Available Tape and Reel at no extra cost

Reel Size	Devices/Reel
7"	20, 50, 100, 200, 500, 1000, 2000

### Applications

- Wi-Fi
- WiMax
- Microwave Radio
- Military & Space

### General Description

Mini-Circuits' XHF-73M+ two-section reflectionless filter employs a patented filter topology which absorbs and terminates stop band signals internally rather than reflecting them back to the source. This new capability enables unique applications for filter circuits beyond those suited to traditional approaches. Traditional filters are reflective in the stop band, sending signals back to the source at 100% of the power level. These reflections interact with neighboring components and often result in inter-modulation and other interferences. Reflectionless filters eliminate stop band reflections, allowing them to be paired with sensitive devices and used in applications that otherwise require circuits such as isolation amplifiers or attenuators.

### simplified schematic and pad description

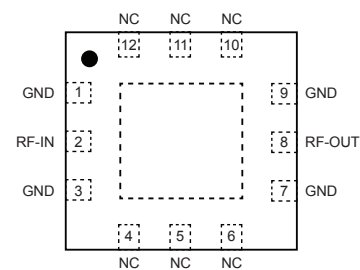
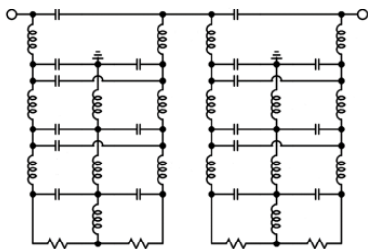

Function	Pad Number	Description
RF-IN	2	RF Input Pad
RF-OUT	8	RF Output Pad
GND	1,3,7,9, Paddle	Connected to ground
NC (GND Externally)	4,5,6,10,11,12	No internal connection



www.minicircuits.com P.O. Box 350166, Brooklyn, NY 11235-0003 (718) 934-4500 sales@minicircuits.com

REV. OR  
M172035  
XHF-73M+  
CM/CP/AM  
190403

Page 2 of 5

Electrical Specifications<sup>1</sup> at 25°C

Parameter	F#	Frequency (MHz)	Min.	Typ.	Max.	Unit	
Stop Band	Rejection	DC-F <sup>1</sup>	DC-4000	22	38	—	dB
		F <sup>1</sup> -F1	4000-5200	19	30	—	dB
	Frequency Cut-Off	F2	6420	—	3.0	—	dB
	VSWR	DC-F <sup>1</sup>	DC-4000	—	1.2	—	:1
		F <sup>1</sup> -F1	4000-5200	—	1.1	—	:1
Pass Band	Insertion Loss	F3-F5	7000-16400	—	1.5	2.8	dB
	VSWR	F3-F5	7000-16400	—	1.1	—	:1

<sup>1</sup> Measured on Mini-Circuits Characterization Test Board TB-844-73MC+

Absolute Maximum Ratings<sup>4</sup>

Parameter	Ratings
Operating Temperature	-55°C to +105°C
Storage Temperature	-65°C to +150°C
RF Power Input, Passband (F3-F5) <sup>2</sup>	1.3W at 25°C
RF Power Input, Stopband (DC-F3) <sup>3</sup>	1.3W at 25°C

<sup>2</sup> Passband rating derates linearly to 0.6W at 105°C ambient

<sup>3</sup> Stopband rating derates linearly to 0.6W at 105°C ambient

<sup>4</sup> Permanent damage may occur if any of these limits are exceeded.

SPECIFICATION DEFINITION

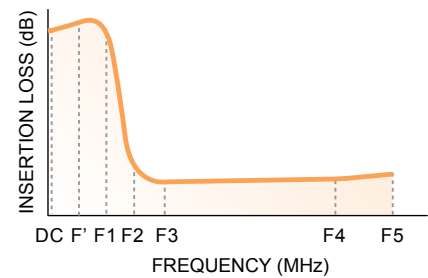

Typical Performance Data at 25°C

Frequency (MHz)	Insertion Loss (dB)	VSWR (:1)
10	63.59	1.17
100	56.47	1.17
500	34.62	1.22
1000	27.46	1.30
1500	27.92	1.34
2000	40.42	1.25
3000	33.59	1.13
4000	39.45	1.22
4500	27.23	1.12
5200	39.60	1.18
6000	4.69	1.03
6420	3.03	1.10
7000	2.15	1.13
8000	1.64	1.06
9000	1.48	1.12
10000	1.46	1.13
12000	1.42	1.27
14000	1.37	1.04
16400	1.63	1.44
18000	1.89	1.67

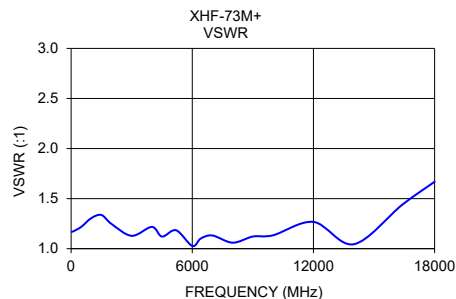
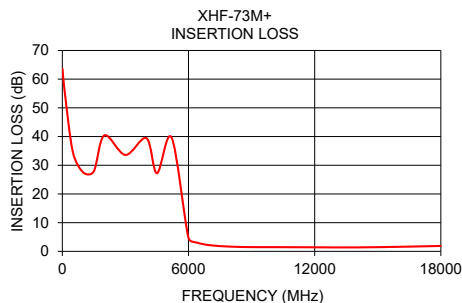

**Product Marking**

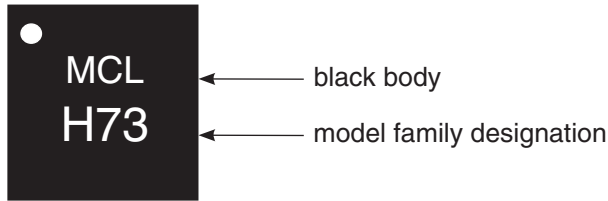

**Additional Detailed Technical Information**

additional information is available on our dash board. To access this information [click here](#)

<b>Performance Data</b>	Data Table
	Swept Graphs
	S-Parameter (S2P Files) Data Set (.zip file)
<b>Case Style</b>	DQ1225 Plastic package, exposed paddle lead finish: matte-tin
<b>Tape &amp; Reel</b> Standard quantities available on reel	F66 7" reels with 20, 50, 100, 200, 500 or 1K devices
<b>Suggested Layout for PCB Design</b>	PL-451
<b>Evaluation Board</b>	TB-844-73M+ (without connectors), TB-844-73MC+ (with connectors)
<b>Environmental Ratings</b>	ENV82

**ESD Rating**

Human Body Model (HBM): Class 2 (Pass 2000V) in accordance with ANSI/ESD STM 5.1 - 2001

**MSL Test Flow Chart**

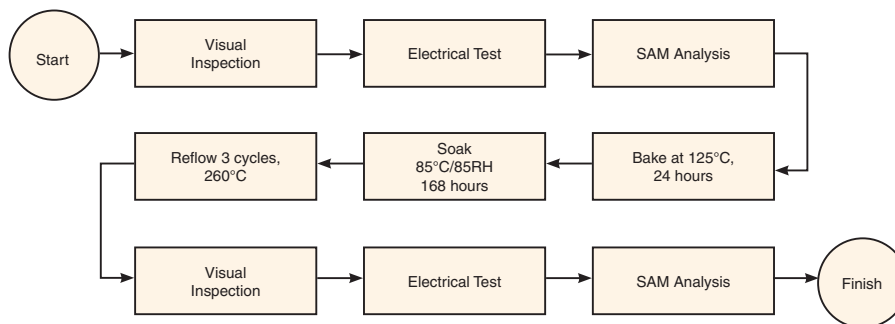

**Additional Notes**

- A. Performance and quality attributes and conditions not expressly stated in this specification document are intended to be excluded and do not form a part of this specification document.
- B. Electrical specifications and performance data contained in this specification document are based on Mini-Circuit's applicable established test performance criteria and measurement instructions.
- C. The parts covered by this specification document are subject to Mini-Circuits standard limited warranty and terms and conditions (collectively, "Standard Terms"); Purchasers of this part are entitled to the rights and benefits contained therein. For a full statement of the Standard Terms and the exclusive rights and remedies thereunder, please visit Mini-Circuits' website at [www.minicircuits.com/MCLStore/terms.jsp](http://www.minicircuits.com/MCLStore/terms.jsp)