

# PE42525

Document Category: Product Specification

UltraCMOS® SPDT RF Switch, 9 kHz–60 GHz



## Features

- Wideband support up to 60 GHz
- Low insertion loss
  - 1.3 dB @ 26.5 GHz
  - 1.7 dB @ 45 GHz
  - 1.9 dB @ 50 GHz
  - 2.7 dB @ 60 GHz
- Fast switching time of 8 ns
- High port to port isolation
  - 41 dB @ 26.5 GHz
  - 38 dB @ 45 GHz
  - 37 dB @ 50 GHz
  - 36 dB @ 60 GHz
- High linearity: IIP3 of 48 dBm
- Flip-chip die, pin-to-pin compatible to the PE42524 and the PE426525

Figure 1 • PE42525 Functional Diagram

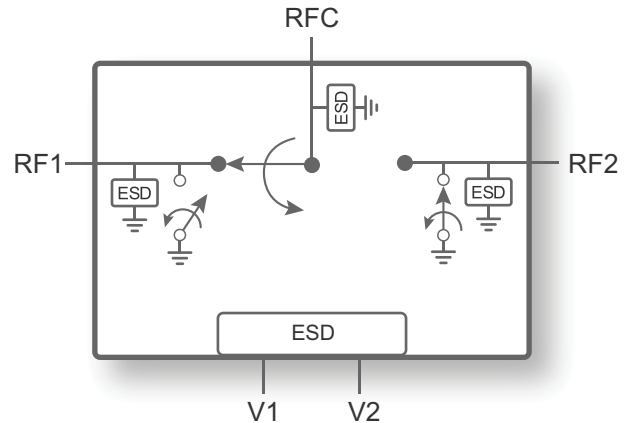

## Applications

- Test and measurement
- Microwave backhaul
- Radar
- Military communications

## Product Description

The PE42525 is a HaRP™ technology-enhanced reflective SPDT RF switch die that supports a wide frequency range from 9 kHz to 60 GHz. This wideband flip-chip switch is pin compatible to the PE42524 and the PE426525. It delivers low insertion loss, fast switching time and high isolation performance, making this device ideal for test and measurement (T&M), microwave backhaul, radar and military communications (mil-comm) applications. At 50 GHz, the PE42525 exhibits 1.9 dB insertion loss and 37 dB isolation. No blocking capacitors are required if DC voltage is not present on the RF ports.

The PE42525 is manufactured on Peregrine's UltraCMOS® process, a patented variation of silicon-on-insulator (SOI) technology.

Peregrine's HaRP technology enhancements deliver high linearity and excellent harmonics performance. It is an innovative feature of the UltraCMOS process, offering the performance of GaAs with the economy and integration of conventional CMOS.

## Absolute Maximum Ratings

Exceeding absolute maximum ratings listed in **Table 1** may cause permanent damage. Operation should be restricted to the limits in **Table 2**. Operation between operating range maximum and absolute maximum for extended periods may reduce reliability.

## ESD Precautions

When handling this UltraCMOS device, observe the same precautions as with any other ESD-sensitive devices. Although this device contains circuitry to protect it from damage due to ESD, precautions should be taken to avoid exceeding the rating specified in **Table 1**.

## Latch-up Immunity

Unlike conventional CMOS devices, UltraCMOS devices are immune to latch-up.

**Table 1 • Absolute Maximum Ratings for PE42525**

Parameter/Condition	Min	Max	Unit
Control voltage (V1, V2)	-3.6	3.6	V
RF input power (RFC–RFX, 50Ω)		Fig. 2	dBm
Maximum junction temperature		+150	°C
Storage temperature range	-65	+150	°C
ESD voltage HBM <sup>(*)</sup>			
All pins		600	V
RF pins to GND		1000	V
<b>Note:</b> * Human body model (MIL-STD 883 Method 3015).			

## Recommended Operating Conditions

Table 2 lists the recommended operating conditions for PE42525. Devices should not be operated outside the recommended operating conditions listed below.

Table 2 • Recommended Operating Condition for PE42525

Parameter	Min	Typ	Max	Unit
Control high (V1, V2)	2.7	3.0	3.3	V
Control low (V1, V2)	-3.3	-3.0	-2.7	V
Control current		390		nA
RF input power, CW (RFC–RFX) <sup>(1)</sup>			Fig. 2	dBm
RF input power, pulsed (RFC–RFX) <sup>(2)</sup>			Fig. 2	dBm
Operating temperature range	-40	+25	+105	°C

**Notes:**  
 1) 100% duty cycle, all bands, 50Ω.  
 2) Pulsed, 5% duty cycle of 4620 μs period, 50Ω.

## Electrical Specifications

Table 3 provides the PE42525 key electrical specifications @ +25 °C, V1 = +3.0V, V2 = -3.0V or V1 = -3.0V, V2 = +3.0V ( $Z_S = Z_L = 50\Omega$ ), unless otherwise specified.

Table 3 • PE42525 Electrical Specifications

Parameter	Path	Condition	Min	Typ	Max	Unit
Operation frequency			9 kHz		60 GHz	As shown
Insertion loss	RFC–RFX	100 MHz		0.9	1.1	dB
		100 MHz–26.5 GHz		1.3	1.6	dB
		26.5–45 GHz		1.7	2.0	dB
		45–50 GHz		1.9	2.3	dB
		50–60 GHz		2.7	3.8	dB
Isolation	All paths	100 MHz	74	80		dB
		100 MHz–26.5 GHz	38	41		dB
		26.5–45 GHz	33	38		dB
		45–50 GHz	32	37		dB
		50–60 GHz	29	36		dB
Return loss (active port)	RFC–RFX	100 MHz		21		dB
		100 MHz–26.5 GHz		17		dB
		26.5–45 GHz		18		dB
		45–50 GHz		15		dB
		50–60 GHz		13		dB

Table 3 • PE42525 Electrical Specifications (Cont.)

Parameter	Path	Condition	Min	Typ	Max	Unit
Return loss (RFC port)	RFC–RFX	100 MHz		21		dB
		100 MHz–26.5 GHz		20		dB
		26.5–45 GHz		18		dB
		45–50 GHz		16		dB
		50–60 GHz		14		dB
2nd harmonic, 2fo	RFC–RFX	+25 dBm output power, 1 GHz		73		dBc
		+25 dBm output power, 2 GHz		77		dBc
		+25 dBm output power, 6.5 GHz		89		dBc
		+25 dBm output power, 13.4 GHz		92		dBc
Input 1dB compression point <sup>(1)</sup>				Fig. 2		dBm
Input IP2		1 GHz		93		dBm
		2 GHz		98		dBm
		6.5 GHz		109		dBm
		13.4 GHz		112		dBm
Input IP3		1 GHz		49		dBm
		2 GHz		48		dBm
		6 GHz		46		dBm
		13.4 GHz		46		dBm
Video feed through <sup>(2)</sup>		DC measurement		30		mV <sub>PP</sub>
RF T <sub>RISE</sub> /T <sub>FALL</sub>		10%/90% RF		3		ns
Settling time		50% CTRL to 0.05 dB final value		48	60	ns
Switching time		50% CTRL to 90% or 10% RF		8	12	ns
<b>Notes:</b>						
1) The input 1dB compression point is a linearity figure of merit. Refer to Table 2 for the RF input power (50Ω).						
2) Measured with a 3.5 ns rise time, –3.0/+3.0V pulse and 100 MHz bandwidth.						

## Control Logic

Table 4 provides the control logic truth table for the PE42525. States 2 and 3 are used in normal switching operations.

Table 4 • Truth Table for PE42525

V1	V2	RF1	RF2	State
–3.0V	–3.0V	OFF	OFF	1
–3.0V	+3.0V	OFF	ON	2
+3.0V	–3.0V	ON	OFF	3
+3.0V	+3.0V	ON	ON	4

Figure 2 • Power De-rating Curve, 9 kHz–60 GHz, –40 °C to +105 °C Ambient, 50Ω

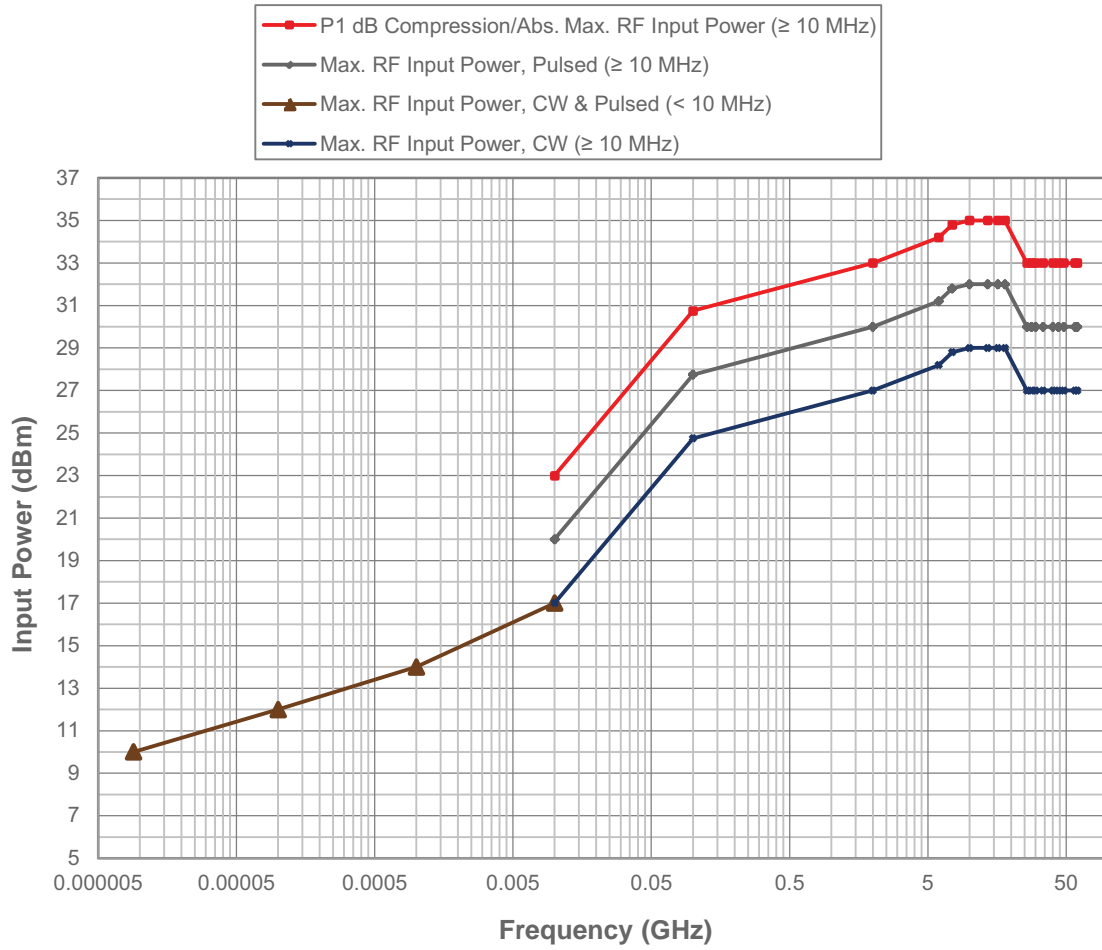

## Typical Performance Data

Figure 3–Figure 12 show the typical performance data at 25 °C, V1 = +3.0V, V2 = –3.0V or V1 = –3.0V, V2 = +3.0V ( $Z_S = Z_L = 50\Omega$ ), unless otherwise specified.

Figure 3 • Insertion Loss vs Temperature (RFC–RFX)

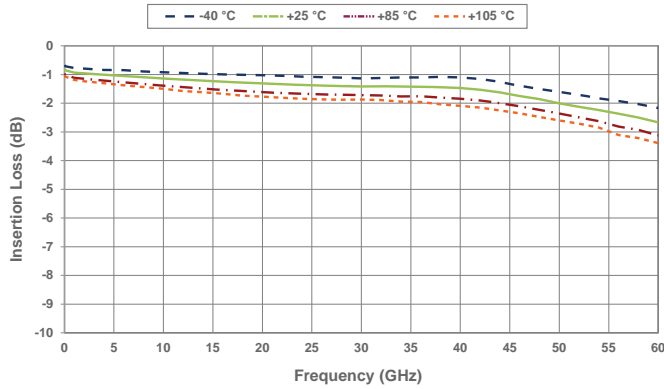

Figure 6 • Insertion Loss vs V1/V2 (RFC–RFX)

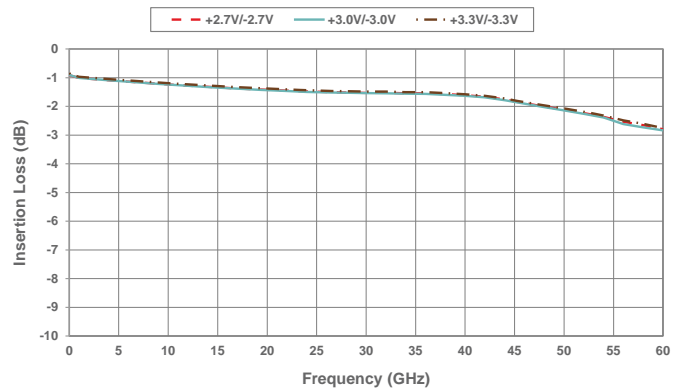

Figure 4 • RFC Port Return Loss vs Temperature

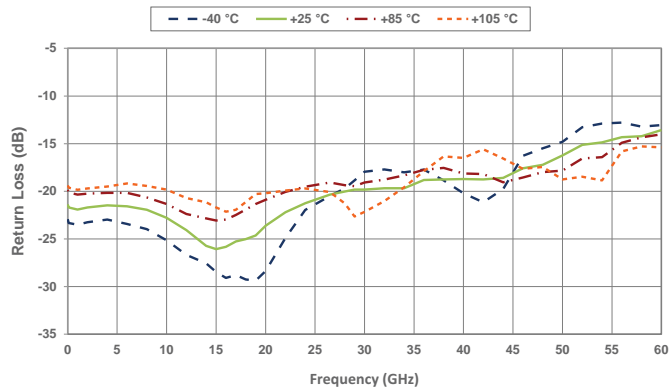

Figure 7 • RFC Port Return Loss vs V1/V2

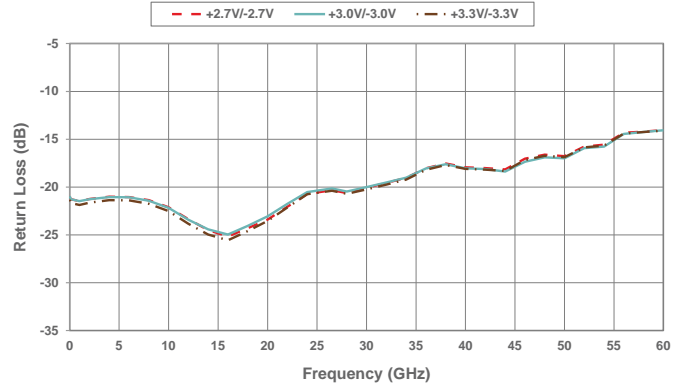

Figure 5 • Active Port Return Loss vs Temperature

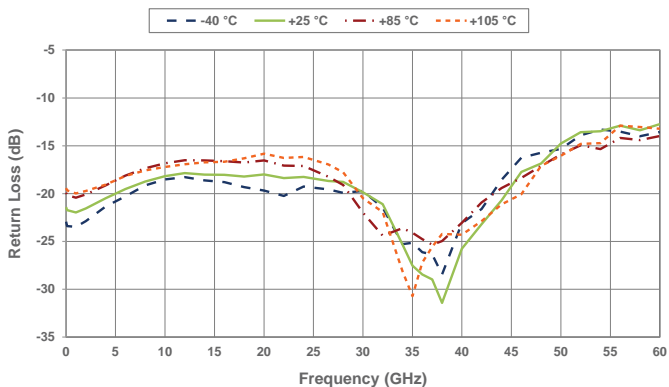

Figure 8 • Active Port Return Loss vs V1/V2

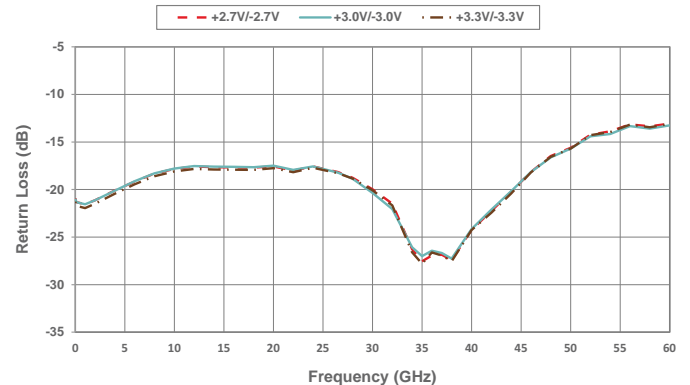

Figure 9 • Isolation vs Temperature (RFX–RFX)

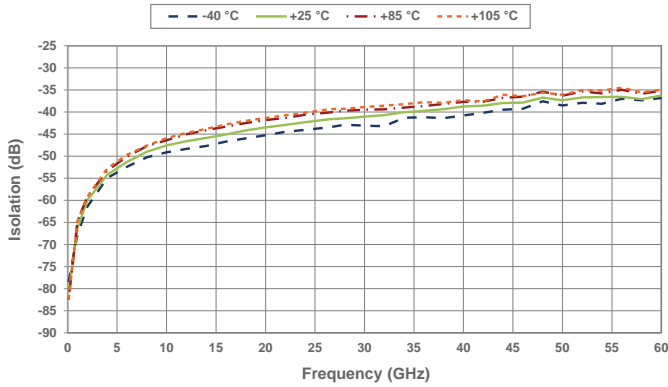

Figure 11 • Isolation vs V1/V2 (RFX–RFX)

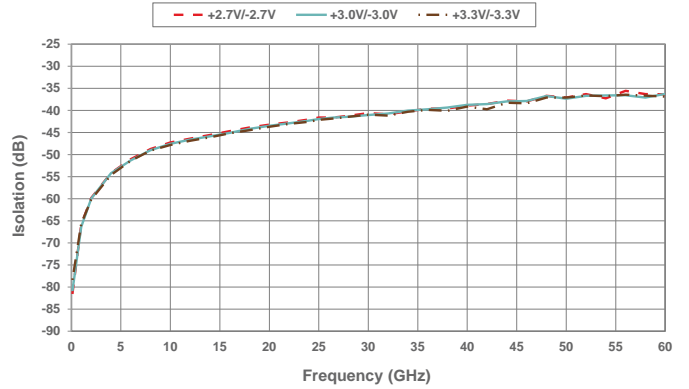

Figure 10 • Isolation vs Temperature (RFC–RFX)

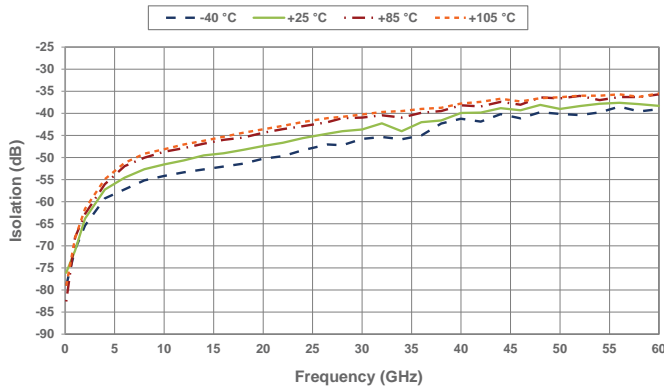
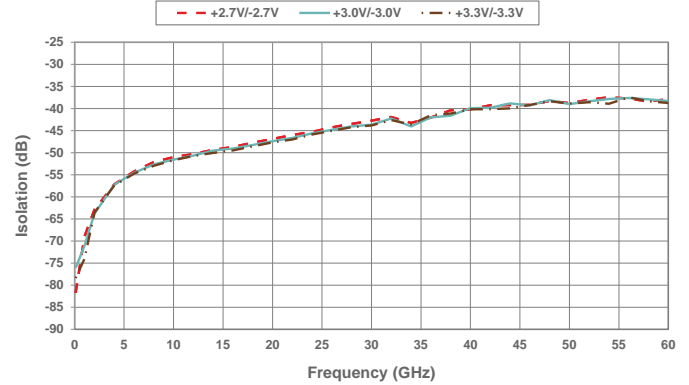

Figure 12 • Isolation vs V1/V2 (RFC–RFX)



## Evaluation Setup

The PE42525 s-parameter data and input 1dB compression point up to 60 GHz (Table 3 and Figure 3–Figure 12) were taken using either co-planar waveguide with ground (CPWG) or grounded co-planar waveguide (GCPW) on an alumina substrate and RF probes.

The PE42525 2nd harmonic, input 1dB compression point below 18 GHz, input IP3 measurements, settling time and switching time (Table 3) were taken on a PCB using 2.92 mm connectors.

Bypass capacitors are not required.

Figure 13 • Alumina Substrate Board for PE42525

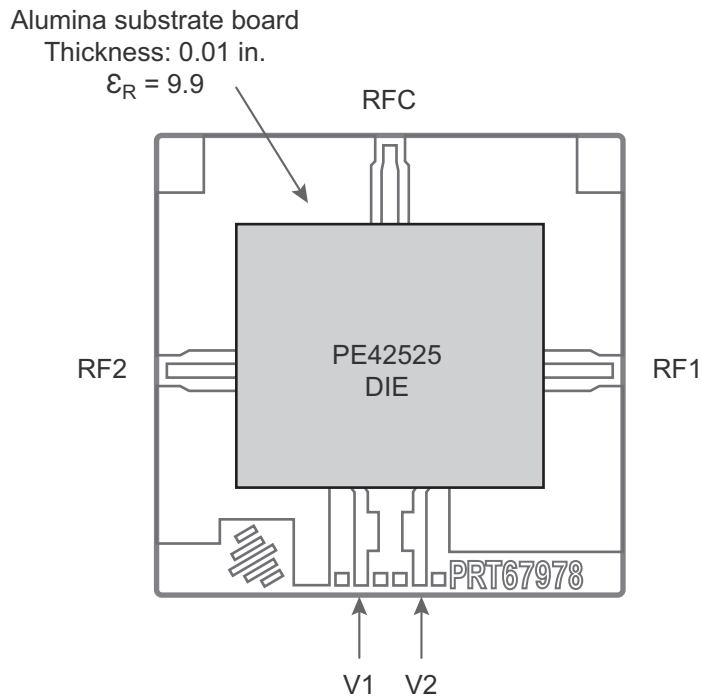



## Pin Configuration

This section provides pin information for the PE42525. **Figure 14** shows the pin configuration of this device. **Table 5** provides a description for each pin.

**Figure 14 • Pin Configuration (Bumps Up) for PE42525**

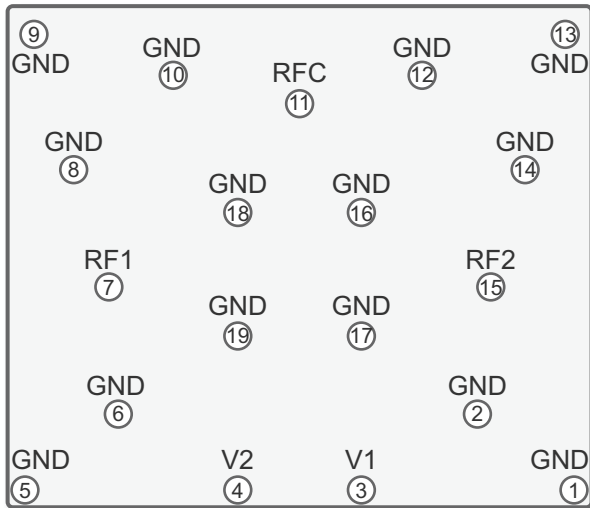

**Table 5 • Pin Descriptions for PE42525**

Pin No.	Pin Name	Description
1, 2, 5, 6, 8–10, 12–14, 16–19	GND	Ground
3	V1	Control input 1
4	V2	Control input 2
7	RF1	RF port 1
11	RFC	RF common port
15	RF2	RF port 2

## Die Mechanical Specifications

This section provides the die mechanical specifications for the PE42525.

**Table 6 • Mechanical Specifications for PE42525**

Parameter	Min	Typ	Max	Unit	Test Condition
Die size, singulated (x, y)	2485 × 2139	2495 × 2149	2505 × 2159	μm	Including excess silicon, maximum tolerance = ±10 μm
Wafer thickness	180	200	220	μm	
Bump pitch	500			μm	
Bump height	59.5	70	80.5	μm	
Bump diameter		91		μm	
UBM diameter	71	75	79	μm	

Table 7 • Pin Coordinates for PE42525<sup>(\*)</sup>

Pin #	Pin Name	Pin Center (μm)	
		X	Y
1	GND	1128.5	-958.5
2	GND	731.5	-646.5
3	V1	253.5	-958.5
4	V2	-253.5	-958.5
5	GND	-1128.5	-958.5
6	GND	-731.5	-646.5
7	RF1	-785.5	-121.5
8	GND	-931.5	363.5
9	GND	-1091.5	913.5
10	GND	-503.5	753.5
11	RFC	0	629
12	GND	503.5	753.5
13	GND	1091.5	913.5
14	GND	931.5	363.5
15	RF2	785.5	-121.5
16	GND	253.5	183.5
17	GND	253.5	-326.5
18	GND	-253.5	183.5
19	GND	-253.5	-326.5

**Note:** \* All pin locations originate from the die center and refer to the center of the pin.

Figure 15 • Pin Layout for PE42525<sup>(1)(2)</sup>

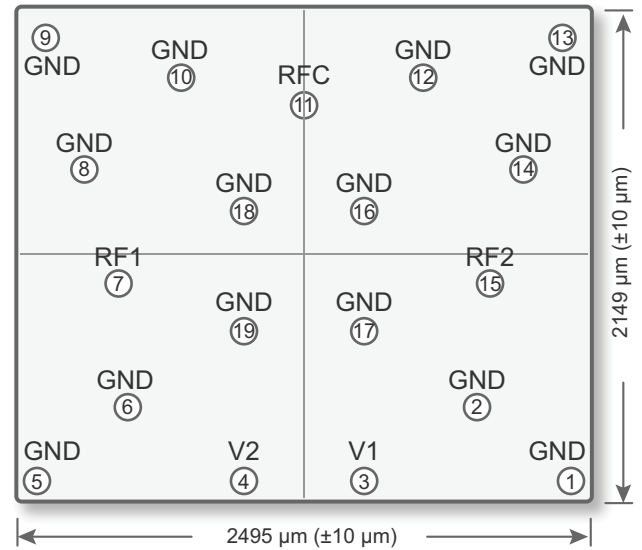

**Notes:**

- 1) Drawings are not drawn to scale.
- 2) Singulated die size shown, bump side up.

## Tape and Reel Specification

This section provides the tape and reel specifications for the PE42525.

Figure 16 • Tape and Reel Specifications for PE42525

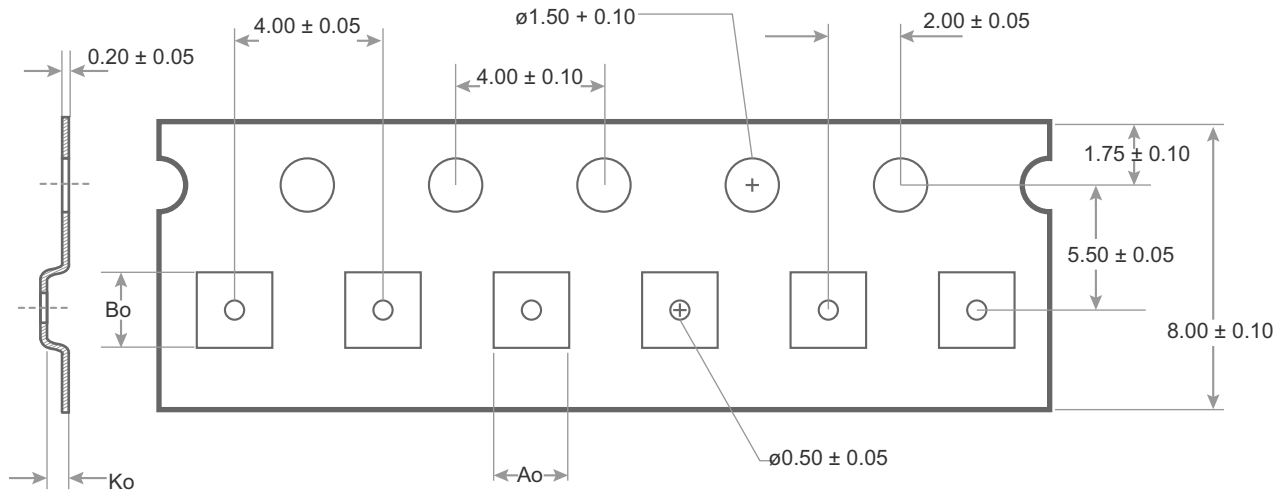

Pocket	Nominal	Tolerance
Ao	2.41	± 0.05
Bo	2.76	± 0.05
Ko	0.39	± 0.05

**Notes:**

- Not Drawn to Scale
- Dimensions are in millimeters
- Maximum cavity angle 5 degrees
- Bumped die are oriented active side down

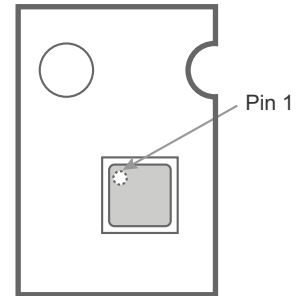

Device Orientation in Tape

## Ordering Information

Table 8 lists the available ordering code for the PE42525 as well as shipping method.

Table 8 • Order Code for PE42525

Order Code	Description	Packaging	Shipping Method
PE42525A-X	PE42525 SPDT RF switch	Die on tape and reel	500 die/T&R

## Document Categories

### Advance Information

The product is in a formative or design stage. The datasheet contains design target specifications for product development. Specifications and features may change in any manner without notice.

### Preliminary Specification

The datasheet contains preliminary data. Additional data may be added at a later date. Peregrine reserves the right to change specifications at any time without notice in order to supply the best possible product.

### Product Specification

The datasheet contains final data. In the event Peregrine decides to change the specifications, Peregrine will notify customers of the intended changes by issuing a CNF (Customer Notification Form).

### Sales Contact

For additional information, contact Sales at sales@psemi.com.

### Disclaimers

The information in this document is believed to be reliable. However, Peregrine assumes no liability for the use of this information. Use shall be entirely at the user's own risk. No patent rights or licenses to any circuits described in this document are implied or granted to any third party. Peregrine's products are not designed or intended for use in devices or systems intended for surgical implant, or in other applications intended to support or sustain life, or in any application in which the failure of the Peregrine product could create a situation in which personal injury or death might occur. Peregrine assumes no liability for damages, including consequential or incidental damages, arising out of the use of its products in such applications.

### Patent Statement

Peregrine products are protected under one or more of the following U.S. patents: patents.psemi.com

### Copyright and Trademark

©2016, Peregrine Semiconductor Corporation. All rights reserved. The Peregrine name, logo, UTSi and UltraCMOS are registered trademarks and HaRP, MultiSwitch and DuNE are trademarks of Peregrine Semiconductor Corp.

### Product Brief

This document contains a shortened version of the datasheet. For the full datasheet, contact sales@psemi.com.

### Not Recommended for New Designs (NRND)

This product is in production but is not recommended for new designs.

### End of Life (EOL)

This product is currently going through the EOL process. It has a specific last-time buy date.

### Obsolete

This product is discontinued. Orders are no longer accepted for this product.