

### Product Overview

The CMD305C4 is a broadband MMIC driver amplifier housed in a leadless 4x4 mm surface mount package. The CMD305C4 is ideally suited for EW and communications systems where small size and low power consumption are needed. The broadband device delivers 18.5 dB of gain and +21 dBm saturated output power at 23% PAE from a single 5 V supply. The CMD305C4 is a 50 ohm matched design eliminating the need for external DC blocks and RF port matching.

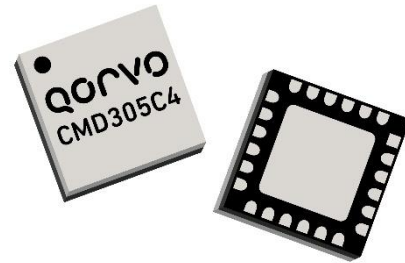

### Functional Block Diagram

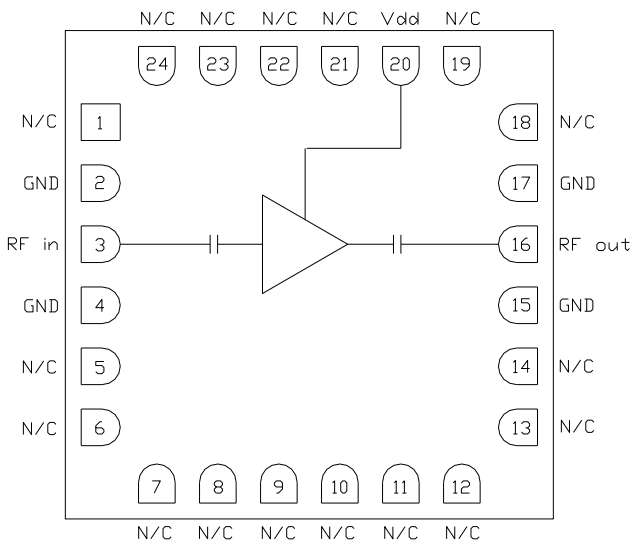

### Key Features

- Broadband Performance
- High Output Power
- Low Current Consumption
- Single Positive Supply Voltage
- Pb-Free RoHs Compliant 4x4 QFN Package

### Ordering Information

| Part No.     | Description        |
|--------------|--------------------|
| CMD305C4     | 100 pcs on 7" reel |
| CMD305C4-EVB | Evaluation Board   |

### Electrical Performance ( $V_{dd} = 5.0\text{ V}$ , $T_A = 25^\circ\text{C}$ , $F = 10\text{ GHz}$ )

| Parameter          | Min | Typ    | Max | Units |
|--------------------|-----|--------|-----|-------|
| Frequency Range    |     | 6 - 16 |     | GHz   |
| Gain               |     | 18.5   |     | dB    |
| Input Return Loss  |     | 13     |     | dB    |
| Output Return Loss |     | 10     |     | dB    |
| Output P1dB        |     | 20     |     | dBm   |
| Output Psat        |     | 21     |     | dBm   |
| Output IP3         |     | 33     |     | dBm   |
| Supply Current     |     | 100    |     | mA    |

## Absolute Maximum Ratings

| Parameter                     | Rating        |
|-------------------------------|---------------|
| Drain Voltage, $V_{dd}$       | 5.5 V         |
| RF Input Power                | +10 dBm       |
| Channel Temperature, $T_{ch}$ | 150° C        |
| Power Dissipation, $P_{diss}$ | 650 mW        |
| Thermal Resistance, $Q_{JC}$  | 100° C/W      |
| Operating Temperature         | -40 to 85° C  |
| Storage Temperature           | -55 to 150° C |

Exceeding any one or combination of the maximum ratings may cause permanent damage to the device.

## Recommended Operating Conditions

| Parameter | Min | Typ | Max  | Units |
|-----------|-----|-----|------|-------|
| $V_{dd}$  | 3.0 | 5.0 | 5.25 | V     |
| $I_{dd}$  |     | 100 |      | mA    |

Electrical performance is measured at specific test conditions. Electrical specifications are not guaranteed over all recommended operating conditions.

## Drain Current vs. Drain Voltage

| $V_{dd}$ (V) | $I_{dd}$ (mA) |
|--------------|---------------|
| 3.0          | 65            |
| 4.0          | 85            |
| 5.0          | 100           |

## Electrical Specifications ( $V_{dd} = 5.0$ V, $T_A = 25^\circ$ C)

| Parameter                    | Min  | Typ   | Max | Min | Typ    | Max | Units |
|------------------------------|------|-------|-----|-----|--------|-----|-------|
| Frequency Range              |      | 6 - 9 |     |     | 9 - 16 |     | GHz   |
| Gain                         | 16   | 19.5  |     | 15  | 18     |     | dB    |
| Noise Figure                 |      | 6     |     |     | 4.5    |     | dB    |
| Input Return Loss            |      | 11    |     |     | 13     |     | dB    |
| Output Return Loss           |      | 11    |     |     | 9      |     | dB    |
| Output P1dB                  | 15.5 | 19    |     | 16  | 20     |     | dBm   |
| Output Psat                  |      | 20    |     |     | 21     |     | dBm   |
| Output IP3                   |      | 32    |     |     | 33     |     | dBm   |
| Supply Current               | 70   | 100   | 130 | 70  | 100    | 130 | mA    |
| Gain Temperature Coefficient |      | 0.016 |     |     | 0.016  |     | dB/°C |

Typical Performance

Broadband Performance,  $V_{dd} = 5.0\text{ V}$ ,  $T_A = 25^\circ\text{ C}$

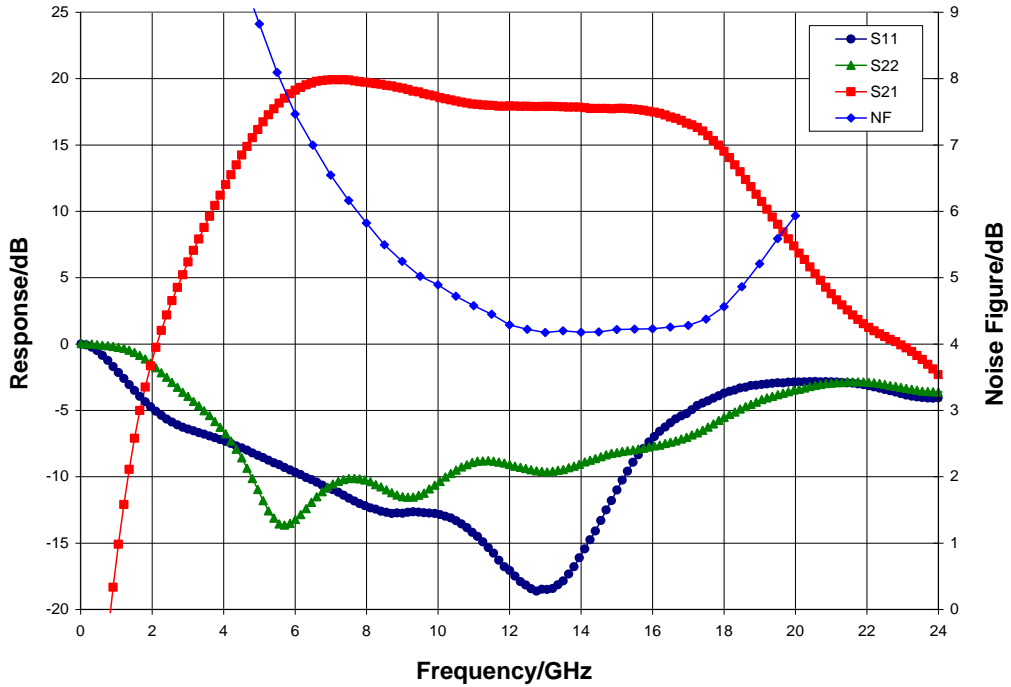

Narrow-band Performance,  $V_{dd} = 5.0\text{ V}$ ,  $T_A = 25^\circ\text{ C}$

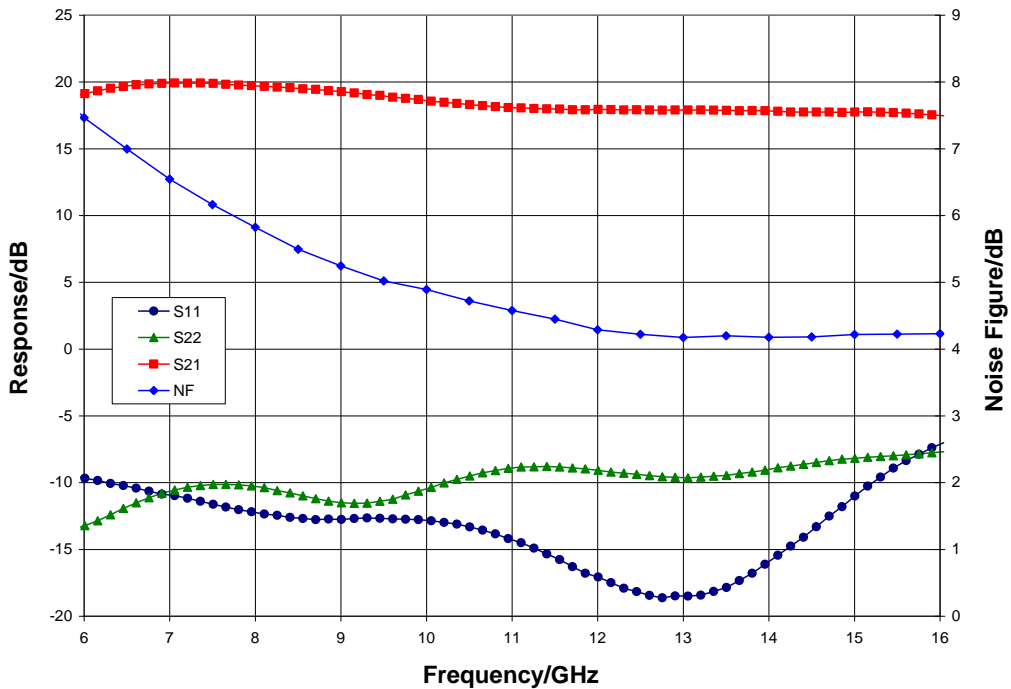

Typical Performance

Gain vs. Temperature,  $V_{dd} = 5.0\text{ V}$

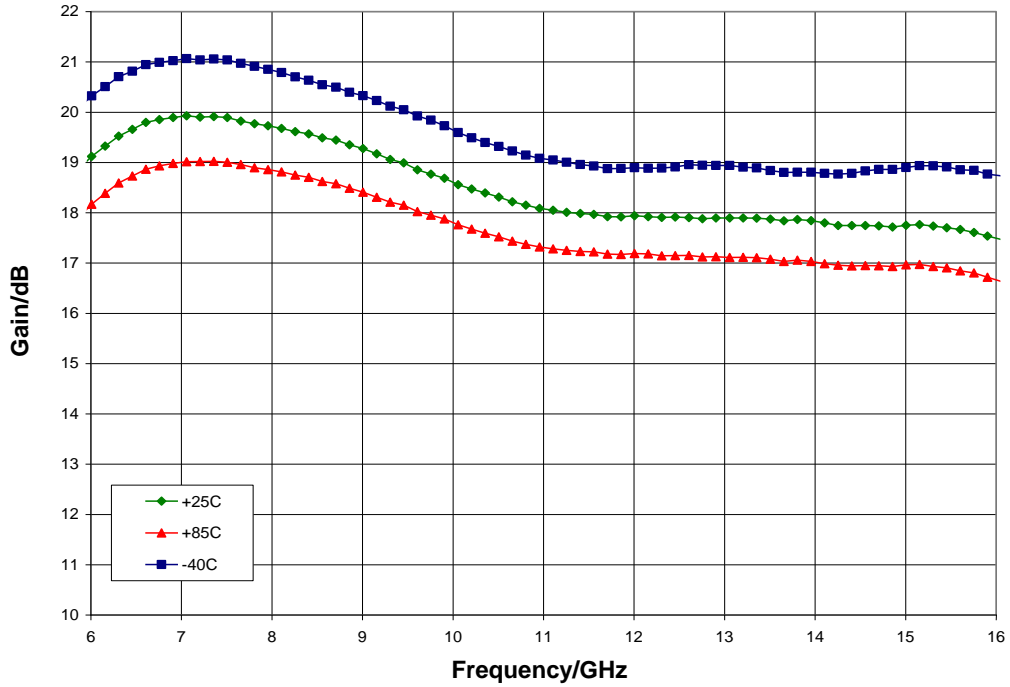

Gain vs.  $V_{dd}$ ,  $T_A = 25^\circ\text{ C}$

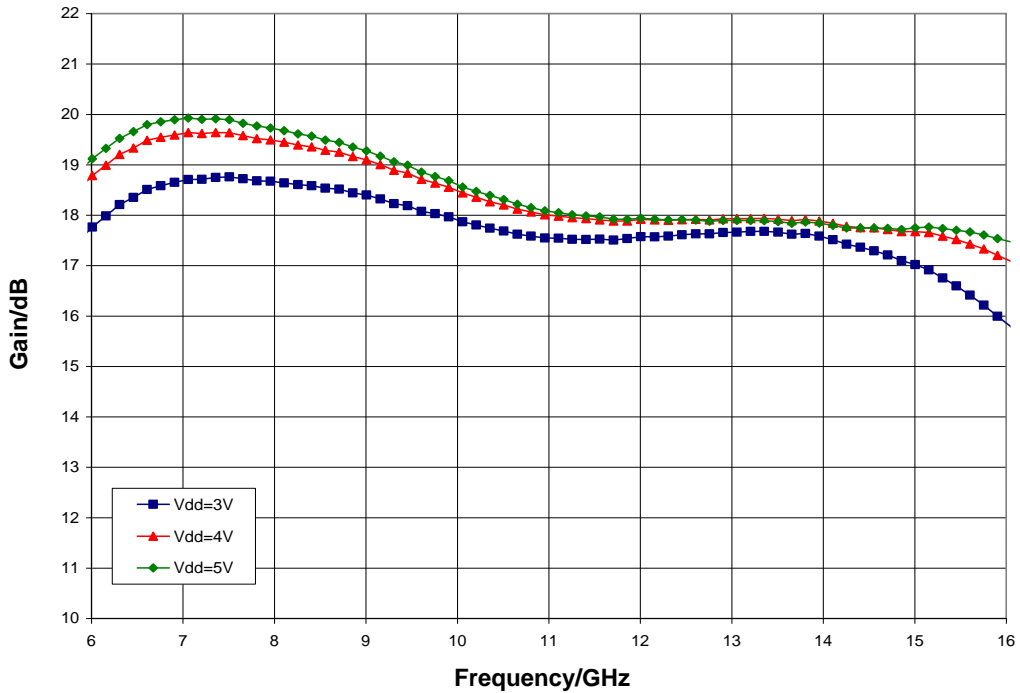

Typical Performance

Noise Figure vs. Temperature,  $V_{dd} = 5.0\text{ V}$

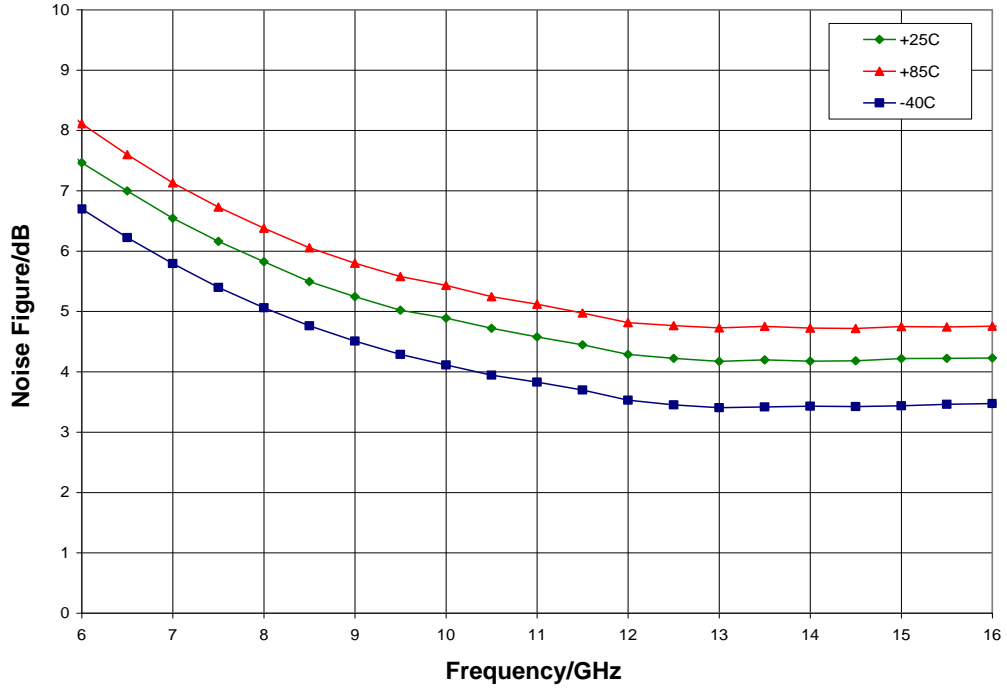

Noise Figure vs.  $V_{dd}$ ,  $T_A = 25^\circ\text{C}$

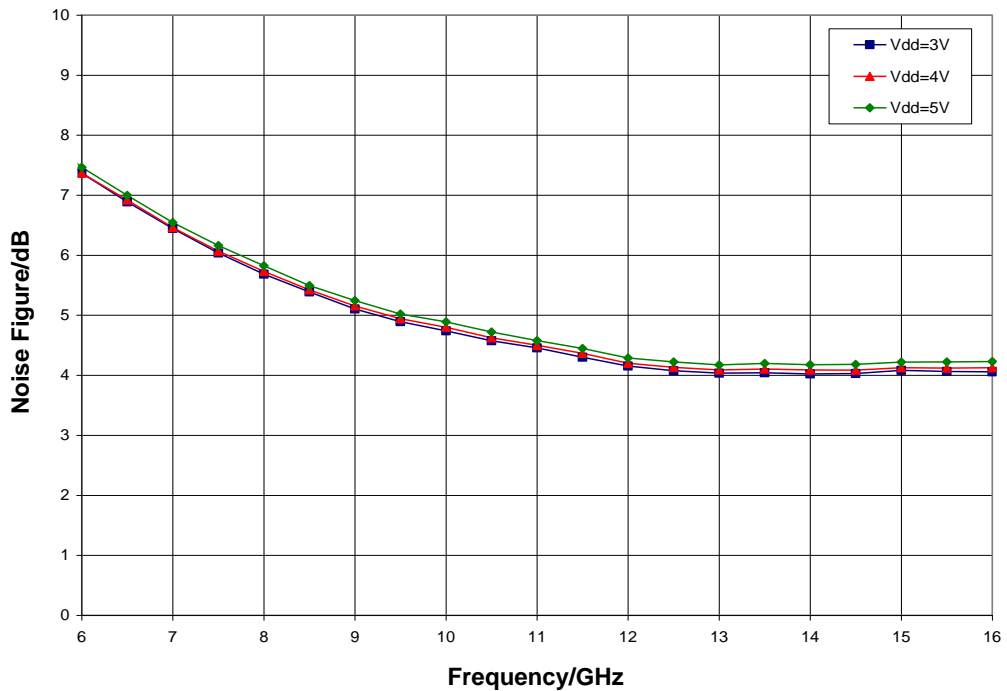

Typical Performance

P1dB vs. Temperature,  $V_{dd} = 5.0\text{ V}$

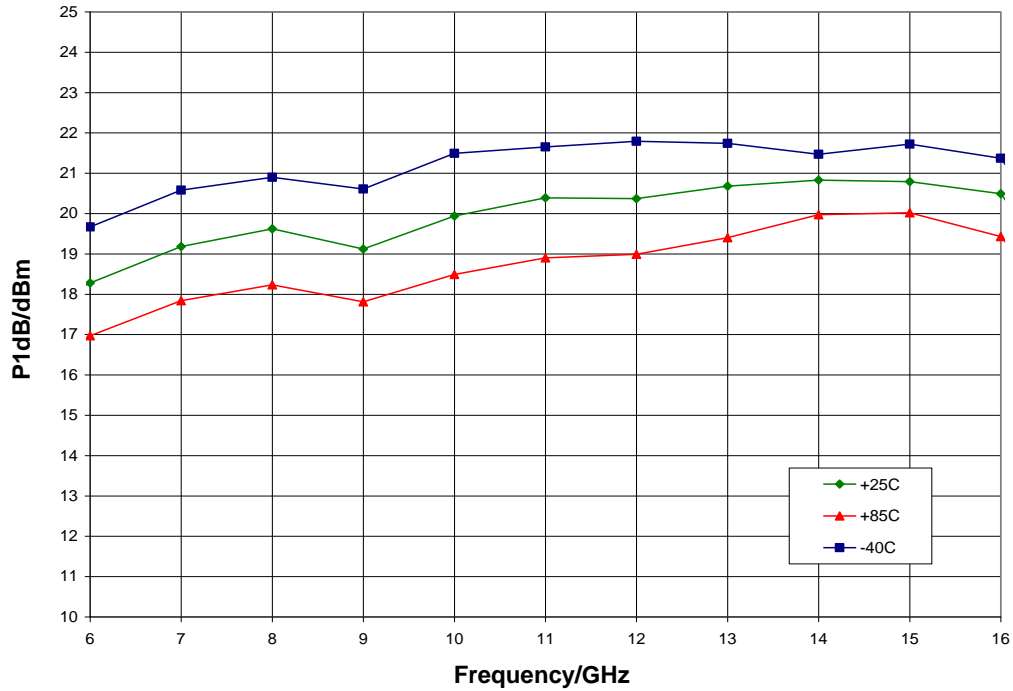

P1dB vs.  $V_{dd}$ ,  $T_A = 25^\circ\text{C}$

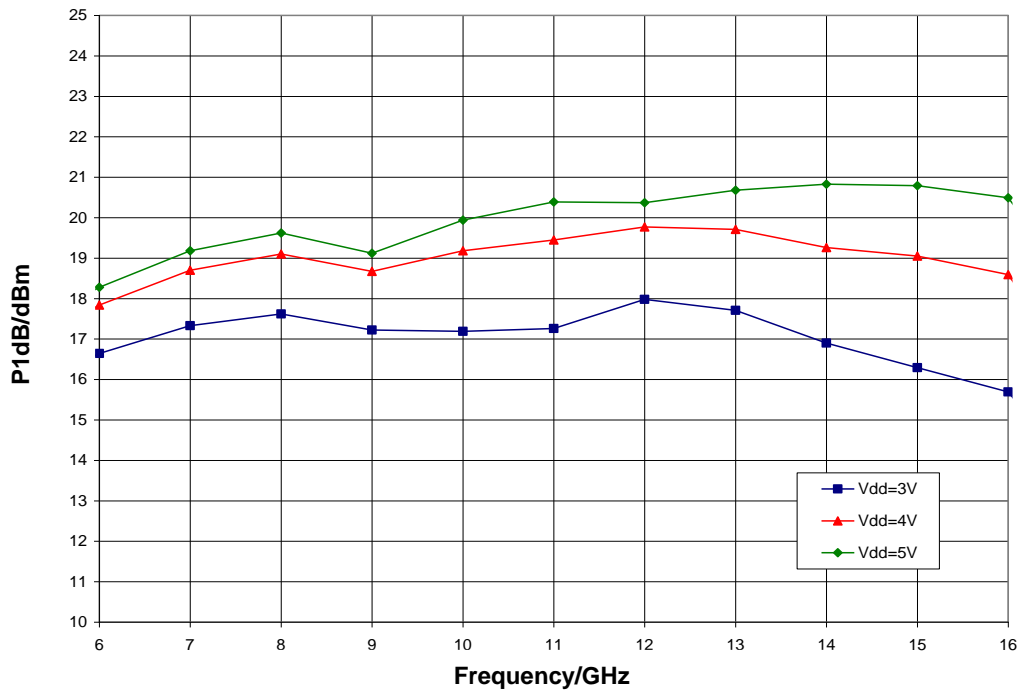

Typical Performance

Psat vs. Temperature,  $V_{dd} = 5.0\text{ V}$

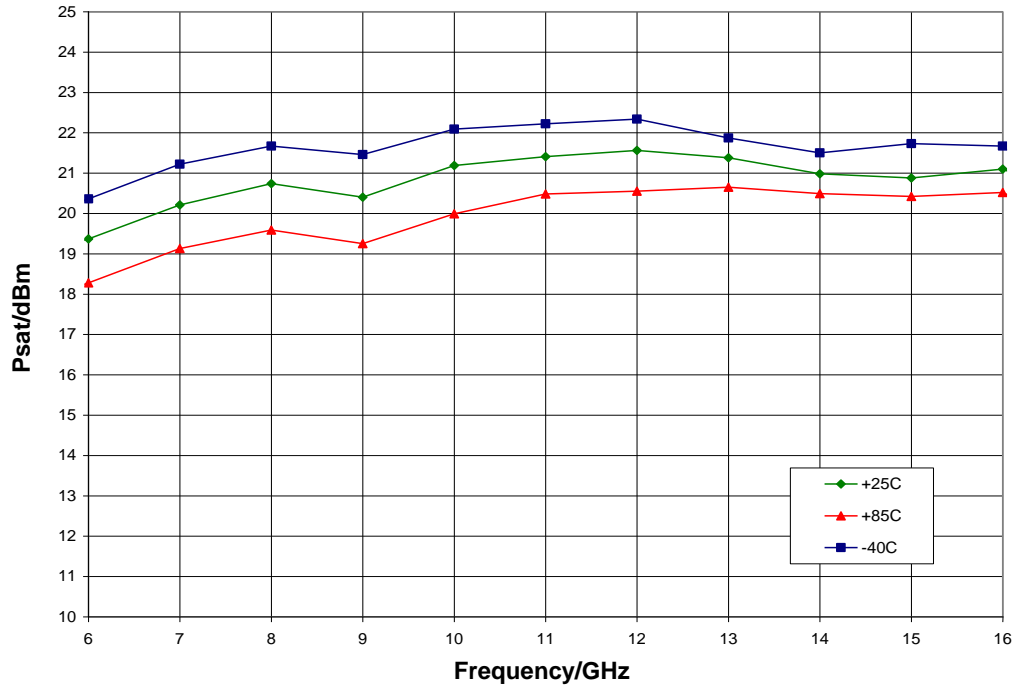

Psat vs.  $V_{dd}$ ,  $T_A = 25^\circ\text{ C}$

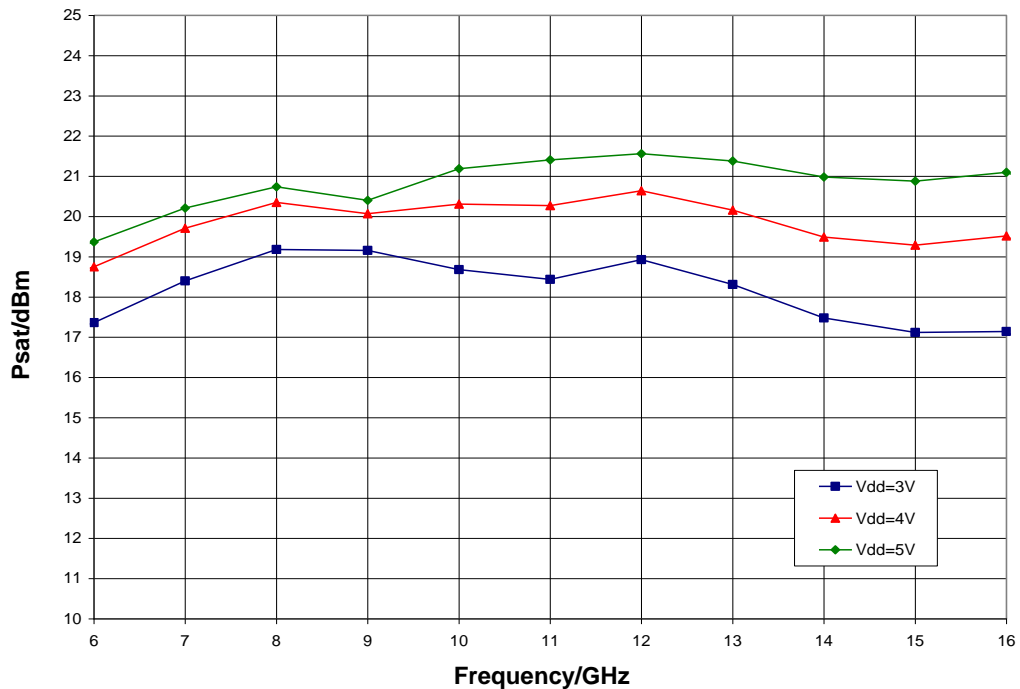

Typical Performance

Output IP3 vs. Temperature,  $V_{dd} = 5.0\text{ V}$

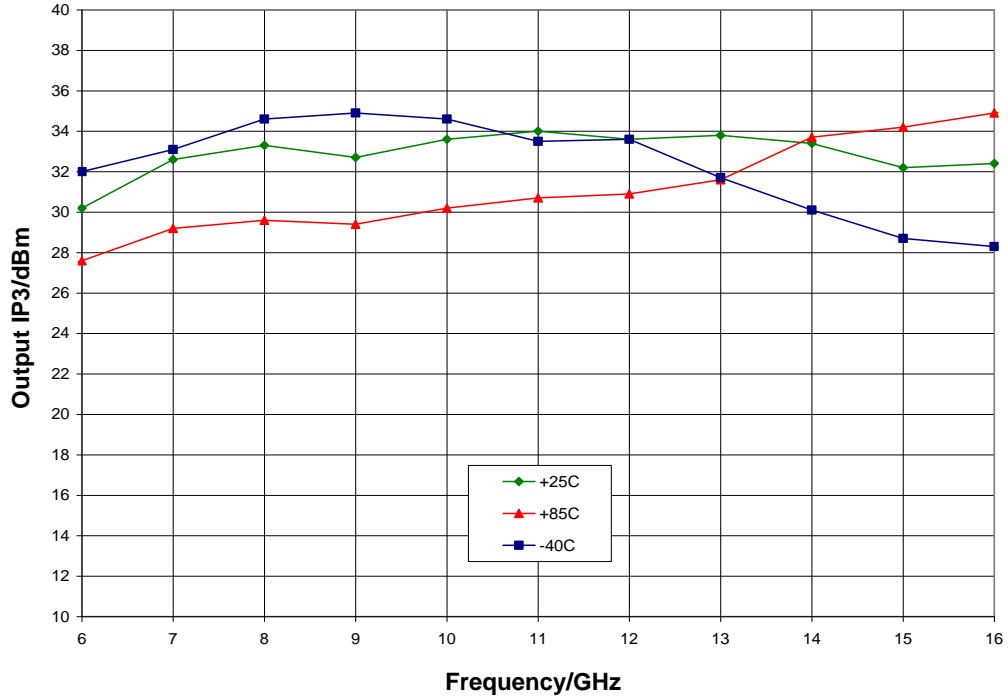

Output IP3 vs.  $V_{dd}$ ,  $T_A = 25^\circ\text{ C}$

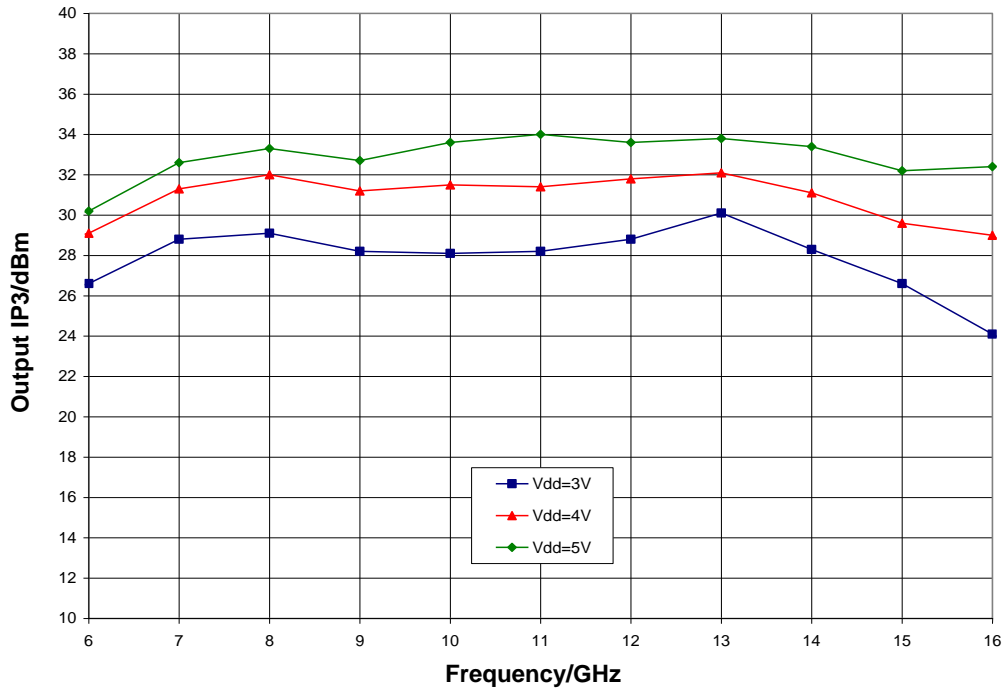



## Mechanical Information

### Package Information and Dimensions

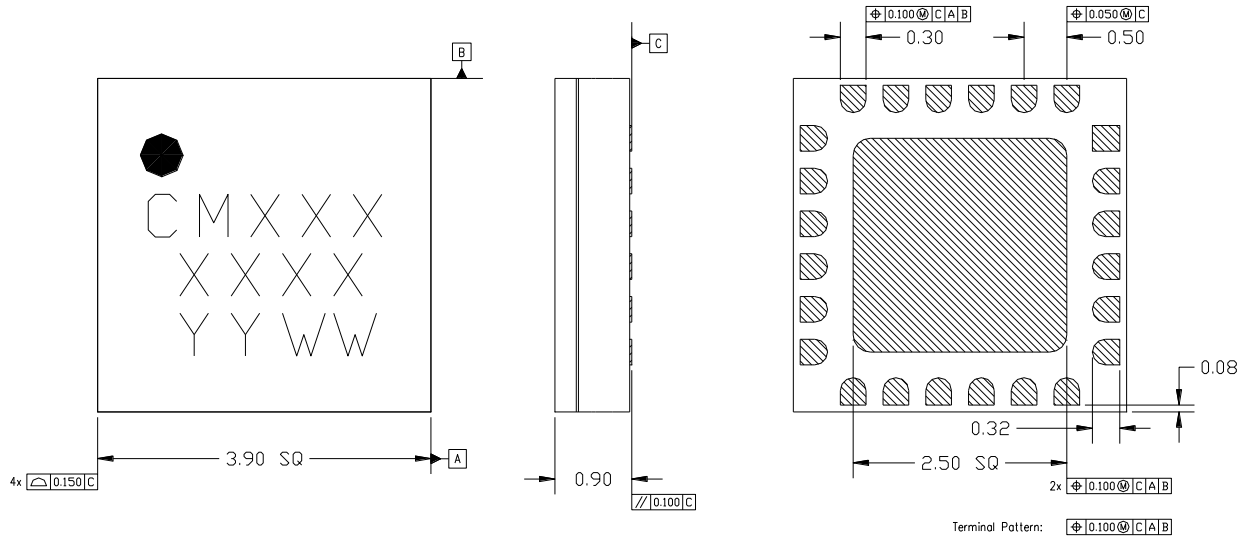

#### Notes:

- All dimensions shown in mm.
- Material: Black alumina
- Lead finish
  - Ni: 8.89um max, 1.27um min
  - Pd: 0.17um max, 0.07um min
  - Au: 0.254um max, 0.03um min
- Marking
  - Line 1: Part number
    - Example: CMD191C4 shall be marked as CM191
  - Line 2: Lot number
  - Line 3: Date code - Last 2 digits of the year of manufacture followed by a 2 digit week code
- Alternate pin #1 identifier is a single square pad
- Alternate die paddle may have chamfered corners

### Recommended PCB Land Pattern

Qorvo recommends that the user develop the land pattern that will provide the best design for proper solder reflow and device attach for their specific application. Please review Qorvo Application Note AN 105 for a recommended land pattern approach.

### Recommended Solder Reflow Profile

Qorvo recommends screen printing with belt furnace reflow to ensure proper solder reflow and device attach. Please review Qorvo Application Note AN 102 for a recommended solder reflow profile.

## Pin Description

### Pin Diagram

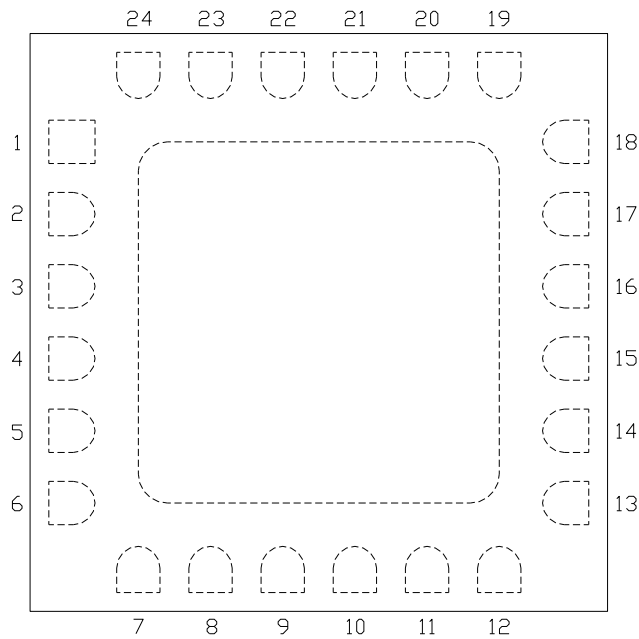

### Functional Description

| Pin                         | Function        | Description   | Schematic |
|-----------------------------|-----------------|---|-----------|
| 1, 5 - 14, 18, 19, 21 - 24  | N/C             | No connection required<br>These pins may be connected to RF / DC ground |           |
| 2, 4, 15, 17 and die paddle | Ground          | Connect to RF / DC ground   |           |
| 3                           | RF in           | DC blocked and 50 ohm matched   |           |
| 16                          | RF out          | DC blocked and 50 ohm matched   |           |
| 20                          | V <sub>dd</sub> | Power supply voltage<br>Decoupling and bypass caps required             |           |

**Applications Information**

**Application Circuit**

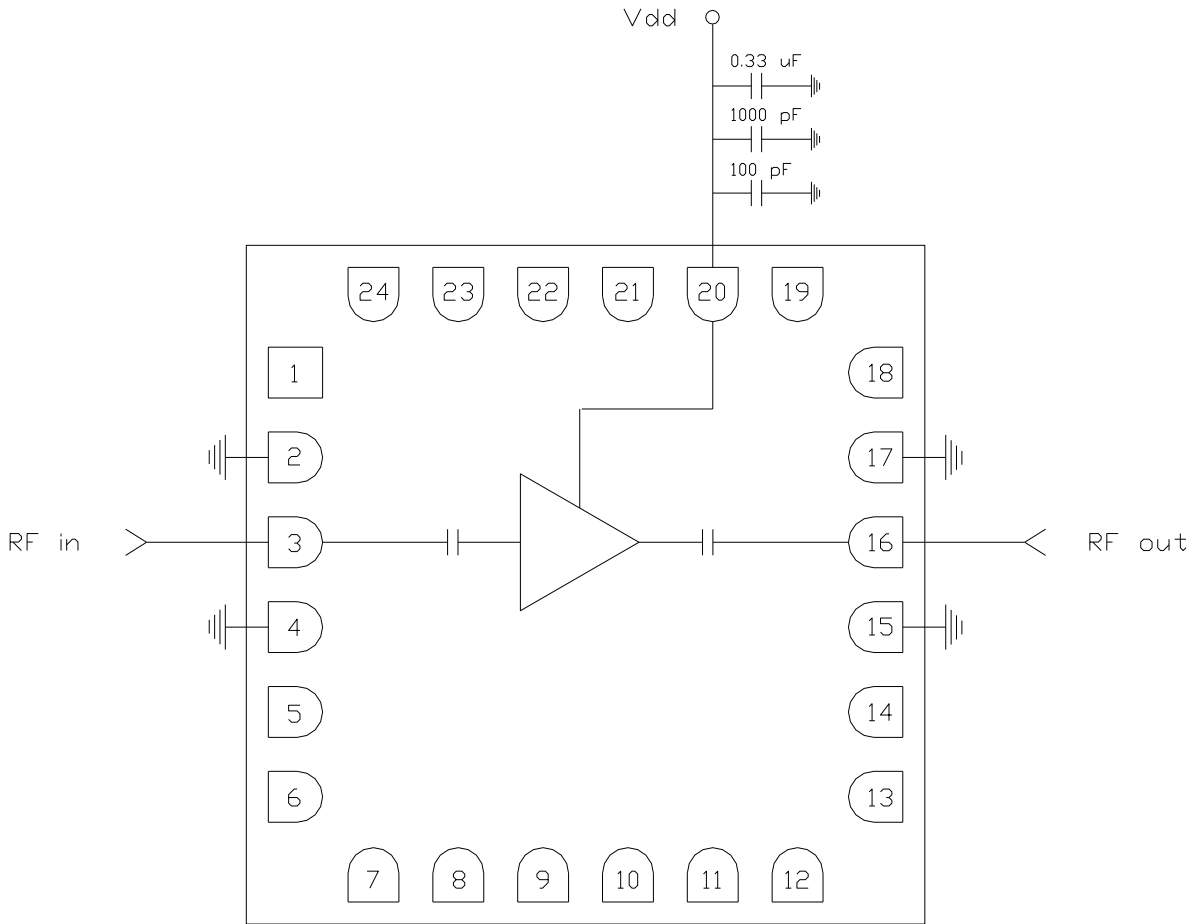

**Biasing and Operation**

The CMD305C4 is biased with a single 5.0 V positive drain supply.

RF power can be applied at any time.

**GaAs MMIC devices are susceptible to damage from Electrostatic Discharge. Proper precautions should be observed during handling, assembly and test.**

## Applications Information

### Evaluation Board

The circuit board shown has been developed for optimized assembly at Qorvo. A sufficient number of via holes should be used to connect the top and bottom ground planes. As surface mount processes vary, careful process development is recommended.

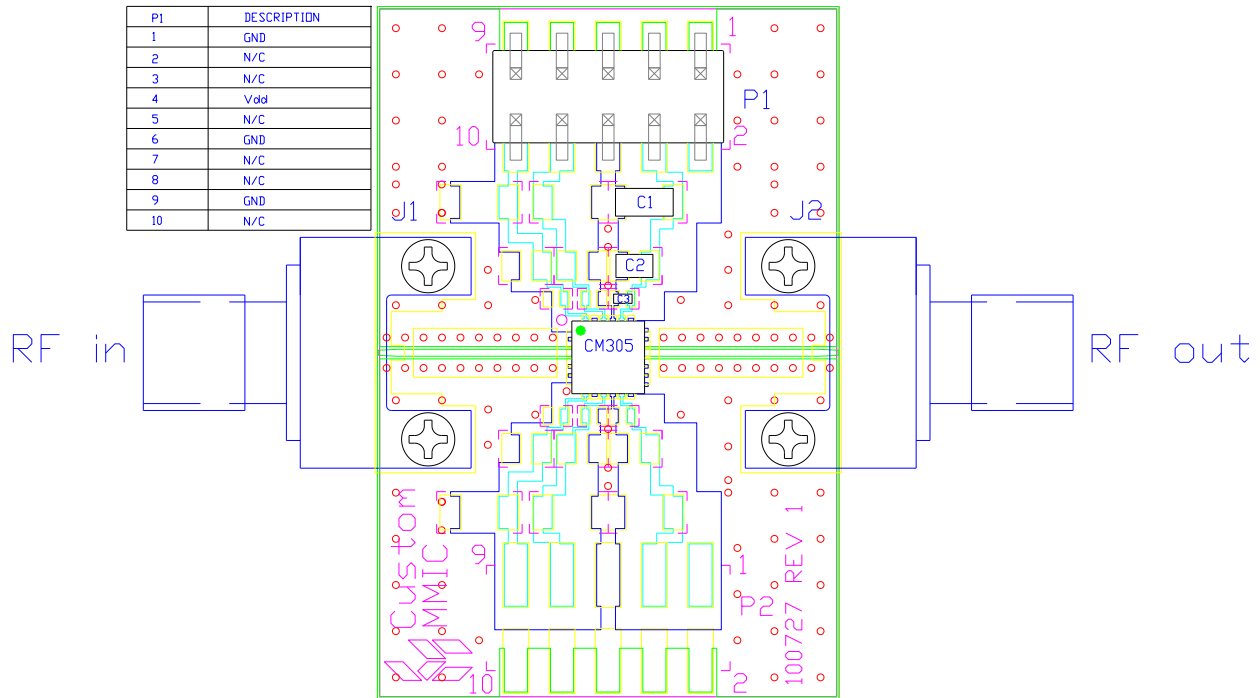

### Bill of Material

| Designator | Value        | Description                  |
|------------|--------------|------------------------------|
| J1, J2     |              | SMA End Launch Connector     |
| P1         |              | 10 Pin Header                |
| C1         | 0.33 $\mu$ F | Capacitor, Tantalum          |
| C2         | 1000 pF      | Capacitor, 0603              |
| C3         | 100 pF       | Capacitor, 0402              |
| U1         |              | CMD305C4 Low Noise Amplifier |
| PCB        |              | 100727 Evaluation PCB        |

## Handling Precautions

| Parameter                        | Rating   | Standard                 |
|----------------------------------|----------|--------------------------|
| ESD – Human Body Model (HBM)     | Class 1A | ESDA / JEDEC JS-001-2012 |
| MSL – Moisture Sensitivity Level | Level 1  | IPC/JEDEC J-STD-020      |



Caution!  
 ESD-Sensitive Device

## RoHS Compliance

This part is compliant with 2011/65/EU RoHS directive (Restrictions on the Use of Certain Hazardous Substances in Electrical and Electronic Equipment) as amended by Directive 2015/863/EU.

This product also has the following attributes:

- Lead Free
- Antimony Free
- TBBP-A (C<sub>15</sub>H<sub>12</sub>Br<sub>4</sub>O<sub>2</sub>) Free
- SVHC Free
- PFOS Free



## Contact Information

For the latest specifications, additional product information, worldwide sales and distribution locations:

**Web:** [www.qorvo.com](http://www.qorvo.com)

**Tel:** 1-844-890-8163

**Email:** [customer.support@qorvo.com](mailto:customer.support@qorvo.com)

## Important Notice

The information contained in this Data Sheet and any associated documents (“Data Sheet Information”) is believed to be reliable; however, Qorvo makes no warranties regarding the Data Sheet Information and assumes no responsibility or liability whatsoever for the use of said information. All Data Sheet Information is subject to change without notice. Customers should obtain and verify the latest relevant Data Sheet Information before placing orders for Qorvo® products. Data Sheet Information or the use thereof does not grant, explicitly, implicitly or otherwise any rights or licenses to any third party with respect to patents or any other intellectual property whether with regard to such Data Sheet Information itself or anything described by such information.

DATA SHEET INFORMATION DOES NOT CONSTITUTE A WARRANTY WITH RESPECT TO THE PRODUCTS DESCRIBED HEREIN, AND QORVO HEREBY DISCLAIMS ANY AND ALL WARRANTIES WITH RESPECT TO SUCH PRODUCTS WHETHER EXPRESS OR IMPLIED BY LAW, COURSE OF DEALING, COURSE OF PERFORMANCE, USAGE OF TRADE OR OTHERWISE, INCLUDING THE IMPLIED WARRANTIES OF MERCHANTABILITY AND FITNESS FOR A PARTICULAR PURPOSE. Without limiting the generality of the foregoing, Qorvo® products are not warranted or authorized for use as critical components in medical, life-saving, or life-sustaining applications, or other applications where a failure would reasonably be expected to cause severe personal injury or death. Applications described in the Data Sheet Information are for illustrative purposes only. Customers are responsible for validating that a particular product described in the Data Sheet Information is suitable for use in a particular application.

© 2020 Qorvo US, Inc. All rights reserved. This document is subject to copyright laws in various jurisdictions worldwide and may not be reproduced or distributed, in whole or in part, without the express written consent of Qorvo US, Inc. | QORVO® is a registered trademark of Qorvo US, Inc.