

RU Series Universal Relays

Key features:

- Full featured universal miniature relays
- Designed with environment taken into consideration
- Two terminal styles: plug-in and PCB mount
- Non-polarized LED indicator
- No internal wires, lead-free construction
- Cadmium-free contacts
- Mechanical flag indicator
- Manual latching lever with color coding for AC or DC coil
- Snap-on yellow marking plate; optional marking plates are available in four other colors
- Maximum contact ratings: 10A (RU2), 6A (RU4), 3A (RU42)
- UL Recognized, CSA Certified, EN Compliant



With Latching or Momentary Lever

Mechanical Indicator*

The contact position can be confirmed through the five small windows.

Marking Plate

Standard yellow marking plate is easily replaced with optional marking plates in four colors for easy identification of relays.

LED Indicator*

Non-polarized green LED indicator is standard provision for plug-in terminal, latching lever types

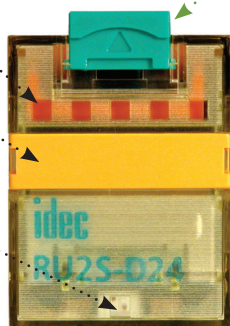

Latching and Momentary Lever

Using the lever, operation can be checked without energizing the coil. The lever is color coded for AC and DC coils.

	Latching	Momentary
AC coil:	Orange	Red
DC coil:	Green	Blue

In Normal Operation



Note: Turn off the power to the relay coil when using the latching lever. After checking the operation, return the latching lever in the normal position.

Standard (without lever)

AC/DC Color Marking

For identification of AC or DC coils.

- AC coil: Yellow
- DC coil: Blue

Mechanical Indicator*

Marking Plate

LED Indicator*

Non-polarized green LED indicator is standard provision for plug-in terminal types.



AC Coil



DC Coil

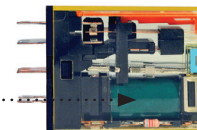

Coil Voltage	Tape Color
24V AC	White
100 to 110V AC	Clear
110 to 120V AC	Blue
200 to 220V AC	Black
220 to 240V AC	Red
24V DC	Green
6V DC	
12V DC	Voltage marking on yellow tape
48V DC	
110V DC	



*Not available on PCB type.

Switches & Pilot Lights

Signaling Lights

Relays & Sockets

Timers

Contactors

Terminal Blocks

Circuit Breakers

Part Number Selection

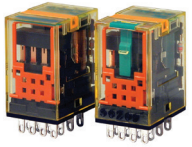
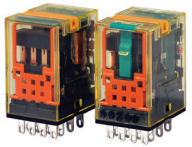
Contact	Model	Part Number			Coil Voltage Code (Standard Stock in bold)
		Standard	With Latching Lever	With Momentary Lever	
DPDT (10A) 	Standard	RU2S-C-□	RU2S-□	RU2S-M-□	A24, A110 , A220 D6, D12, D24 , D48, D110
	With RC (AC coil only)	RU2S-CR-□	RU2S-R-□	RU2S-MR-□	A110, A220
	With diode (DC coil only)	RU2S-CD-□	RU2S-D-□	RU2S-MD-□	D6, D12, D24 , D48, D110
	PCB	RU2V-NF-□	—	—	A24, A110, A220 D6, D12, D24 , D48, D110
4PDT (6A) 	Standard	RU4S-C-□	RU4S-□	RU4S-M-□	A24, A110 , A220 D6, D12, D24 , D48, D110
	With RC (AC coil only)	RU4S-CR-□	RU4S-R-□	RU4S-MR-□	A110, A220
	With diode (DC coil only)	RU4S-CD-□	RU4S-D-□	RU4S-MD-□	D6, D12, D24, D48, D110
	PCB	RU4V-NF-□	—	—	A24, A110 , A220 D6, D12, D24 , D48, D110
4PDT Bifurcated (3A) 	Standard	RU42S-C-□	RU42S-□	RU42S-M-□	A24, A110, A220 D6, D12, D24 , D48, D110
	With RC (AC coil only)	RU42S-CR-□	RU42S-R-□	RU42S-MR-□	A110, A220
	With diode (DC coil only)	RU42S-CD-□	RU42S-D-□	RU42S-MD-□	D6, D12, D24, D48, D110
	PCB	RU42V-NF-□	—	—	A24, A110, A220 D6, D12, D24 , D48, D110

- 1. Plug-in terminal models have an LED indicator and a mechanical indicator as standard.
- 2. PCB models do not have an LED indicator or a mechanical indicator.

Ordering Information





When ordering, specify the Part No. and coil voltage code:

(example) **RU2S-C** **A110**
Part No. Coil Voltage Code

Coil Voltage Table

Coil Voltage Code	A24	A110	A220	D6	D12	D24	D48	D110
Coil Rating	24V AC	110-120V AC	220-240V AC	6V DC	12V DC	24V DC	48V DC	110V DC

Sockets

Relays	Spring Clamp DIN Rail Mount	Standard DIN Rail Mount	Finger-safe DIN Rail Mount	Panel Mount	PCB Mount
RU2S (DPDT)	SU2S-11L	SM2S-05	SM2S-05C	SY4S-51	SM2S-61 SM2S-62
RU4S (4PDT) RU42S (4PDT)	SU4S-11L	SY4S-05	SY4S-05C		SY4S-61 SY4S-62
					

Switches & Pilot Lights

Signaling Lights

Relays & Sockets

Timers



Contactors

Terminal Blocks

Circuit Breakers

Switches & Pilot Lights

Hold Down Springs & Clips

Appearance	Item	Relay	For DIN Mount Socket	For Through Panel & PCB Mount Socket
	Pullover Wire Spring	RU2S/RU4S/ RU42S	SY4S-02F1	SY4S-51F1
	Leaf Spring (side latch)	RU2S/RU4S/ RU42S	SFA-202*	SFA-302*
	Leaf Spring (top latch)	RU2S/RU4S/ RU42S	SFA-101*	SFA-301*



Note: Order 2 pieces for each relay

Signaling Lights

Relays & Sockets

Accessories

Name	Part Number	Color Code *
Marking Plate	RU9Z-P*	A (orange), G (green), S (blue), W (white), Y (yellow)



Specify a color code when ordering. The marking plate can be removed from the relay by inserting a flat screwdriver under the marking plate.

Timers

Specifications

Model (Contact)	RU2 (DPDT)	RU4 (4PDT)	RU42 (4PDT-bifurcated)
Contact Material	Silver alloy	Silver (gold clad)	Silver-nickel (gold clad)
Contact Resistance ¹	50 mΩ maximum		
Minimum Applicable Load ²	24V DC, 5 mA (reference value)	1V DC, 1 mA	1V DC, 0.1 mA
Operating Time ³	20 ms maximum		
Release Time ³	20 ms maximum		
Power Consumption	AC: 1.1 to 1.4VA (50 Hz), 0.9 to 1.2VA (60 Hz) DC: 0.9 to 1.0W		
Insulation Resistance	100MΩ minimum (500V DC megger)		
Dielectric Strength	Between contact and coil: 2500V AC, 1 minute		
	Between contacts of different poles:		
	2500V AC, 1 minute	2000V AC, 1 minute	
Operating Frequency	Electrical: 1800 operations/h maximum		
	Mechanical: 18,000 operations/h maximum		
Vibration Resistance	Damage limits: 10 to 55 Hz, amplitude 0.5 mm Operating extremes: 10 to 55 Hz, amplitude 0.5 mm		
Shock Resistance	Damage limits: 1000 m/s ² (100G) Operating extremes: 150 m/s ² (15G)		
Mechanical Life	AC: 50,000,000 operations DC: 100,000,000 operations	50,000,000 operations	
Electrical Life ⁴	See table on page 894		
Operating Temperature ⁵	PCB model: -55 to +70°C (no freezing) Blade model: -55 to +60°C (no freezing)		
Operating Humidity	5 to 85% RH (no condensation)		
Weight	Approx. 35g		

Contactors



Terminal Blocks

Circuit Breakers



1. Measured using 5V DC, 1A voltage drop method
2. Measured at operating frequency of 120 operations/min (failure rate level P, reference value)
3. Measured at the rated voltage (at 20°C), excluding contact bouncing;
Release time of AC relays with RC: 25 ms maximum
Release time of DC relays with diode: 40 ms maximum
4. Contact Load and Electrical Life (at ambient temperature 20°C)
5. Measured at the rated voltage.

Accessories

Item	Appearance	Use with	Part No.	Remarks
Aluminum DIN Rail (1 meter length)		All DIN rail sockets	BNDN1000	The BNDN1000 is designed to accommodate DIN mount sockets. Made of durable extruded aluminum, the BNDN1000 measures 0.413 (10.5mm) in height and 1.37 (35mm) in width (DIN standard). Standard length is 39" (1,000mm).
DIN Rail End Stop		DIN rail	BNL5	9.1 mm wide.
Replacement Hold-Down Spring Anchor		Horseshoe clip for DIN rail sockets	Y778-011	For use on DIN rail mount socket when using pullover wire hold down spring. 2 pieces included with each socket.

Coil Ratings

Rated Voltage (V)	Coil Voltage Code	Rated Current (mA) ±15% (at 20°C)		Coil Resistance (Ω) ±10% (at 20°C)	Operating Characteristics (values at 20°C)		
		50 Hz	60 Hz		Maximum Continuous Applied Voltage	Pickup Voltage	Dropout Voltage
AC (50/60 Hz)	24	A24	49.3	42.5	110%	80% maximum	30% minimum
	110-120	A110	8.4-10.0	7.1-8.2			
	220-240	A220	4.2-5.0	3.6-4.2			
DC	6	D6	155		110%	80% maximum	10% minimum
	12	D12	80				
	24	D24	44.7				
	48	D48	18				
	110	D110	8.9				

 1. The rated current includes the current of the LED indicator.

Surge Suppressor Ratings

Model		Ratings
AC Coil	With RC	RC series circuit R: 20 kΩ, C: 0.033 μF
DC Coil	With Diode	Diode reverse voltage: 1000V Diode forward current: 1A

UL and c-UL Ratings

Voltage	Resistive			General Use			Horse Power Rating		
	RU2	RU4	RU42	RU2	RU4	RU42	RU2	RU4	RU42
250V AC	10A	—	3A	—	6A	—	—	1/10HP	—
30V DC	10A	6A	3A	—	—	—	—	—	—

Contact Ratings

Maximum Contact Capacity						
Contact	Continuous Current	Allowable Contact Power		Voltage (V)	Rated Load	
		Resistive Load	Inductive Load		Res. Load	Ind. Load
DPDT	10A	2500VA AC	1250VA AC	250 AC	10A	5A
		300W DC	150W DC	30 DC	10A	5A
4PDT	6A	1500VA AC	600VA AC	250 AC	6A	0.8A
		180W DC	90W DC	30 DC	6A	1.5A
4PDT bifurcated	3A	750VA AC	200VA AC	250 AC	3A	0.8A
		90W DC	45W DC	30 DC	3A	1.5A

 1. On 4PDT relays, the maximum allowable total current of neighboring two poles is 6A. At the rated load, make sure that the total current of neighboring two poles does not exceed 6A (3A + 3A = 6A).
2. Inductive load for the rated load — cos θ = 0.3, L/R = 7 ms

CSA Ratings

Voltage	Resistive
	RU42
250V AC	3A
30V DC	3A

TÜV Ratings

Voltage	Resistive			Inductive		
	RU2	RU4	RU42	RU2	RU4	RU42
250V AC	10A	6A	3A	5A	0.8A	0.8A
30V DC	10A	6A	3A	5A	1.5A	1.5A

Switches & Pilot Lights

Signaling Lights

Relays & Sockets

Timers

Contactors

Terminal Blocks

Circuit Breakers

Socket Specifications

	Sockets	Terminal	Electrical Rating	Wire Size	Torque
DIN Rail Mount Sockets	SU2S-11L	Spring clamp terminals	250V/10A	24-16 AWG	—
	SU4S-11L	Spring clamp terminals	250V/6A (using RU4), 10A (using RU2)	24-16 AWG	—
	SM2S-05	M3 screw with captive wire clamp	300V, 10A	Maximum up to 2-#14AWG	5.5 - 9in•lbs
	SM2S-05C	M3 screw with captive wire clamp, fingersafe	300V, 10A	Maximum up to 2-#14AWG	5.5 - 9in•lbs
	SY4S-05	M3 screw with captive wire clamp	300V, 7A (using RU4), 10A (using RU2)	Maximum up to 2-#14AWG	5.5 - 9in•lbs
	SY4S-05C	M3 screw with captive wire clamp, fingersafe	300V, 7A (using RU4), 10A (using RU2)	Maximum up to 2-#14AWG	5.5 - 9in•lbs
Through Panel Mount Socket	SY4S-51	Solder	300V, 7A	—	—
PCB Mount Socket	SY4S-61	PCB mount	300V, 7A	—	—
	SY4S-62	PCB mount	250V, 7A	—	—

Electrical Life Curves

RU2 (Resistive Load)

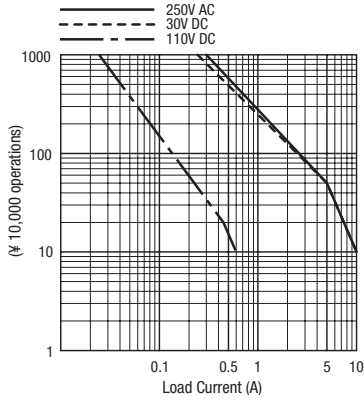

RU4 (Resistive Load)

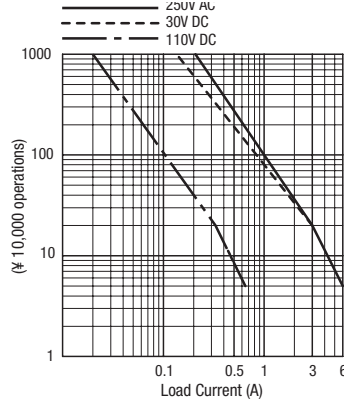

RU42 (Resistive Load)

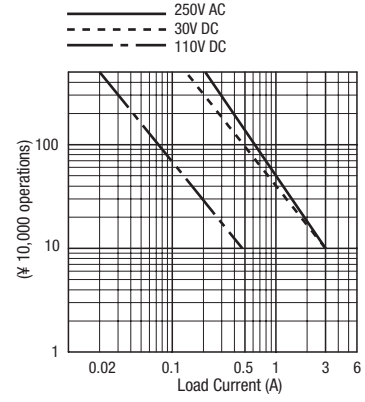

RU2 (Inductive Load)

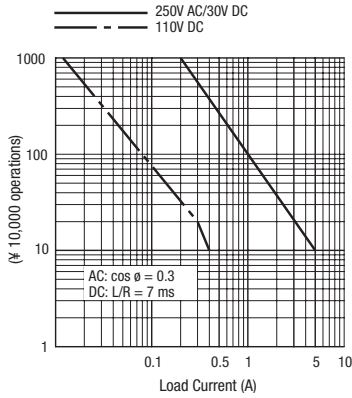

RU4 (Inductive Load)

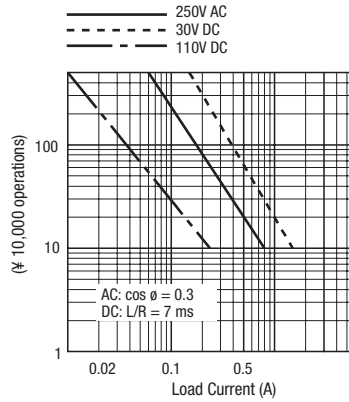

RU42 (Inductive Load)

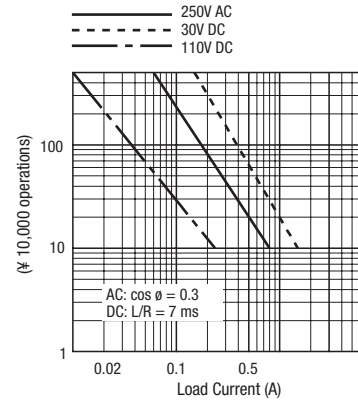

Maximum Switching Current

RU2

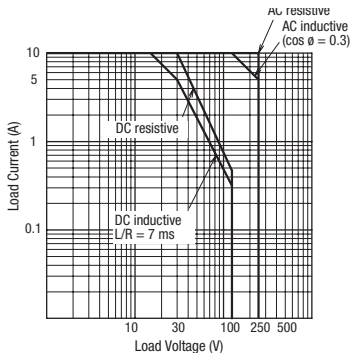

RU4

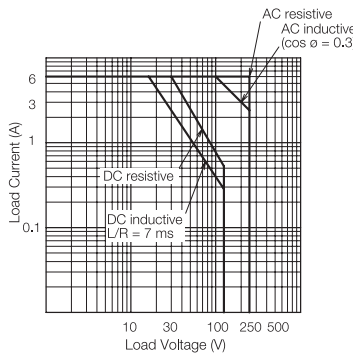

RU42 (Bifurcated)

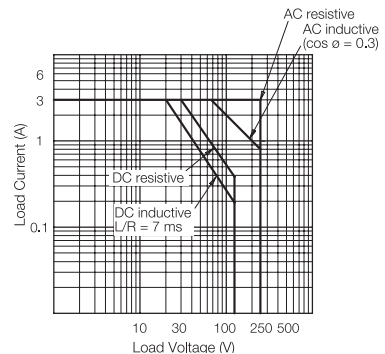

Ambient Temperature vs. Temperature Rise Curves

RU2 (AC Coil, 50 Hz)

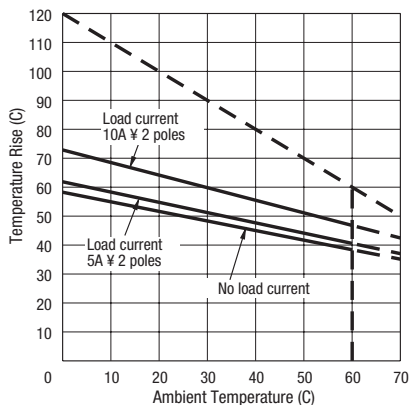

RU2 (AC Coil, 60 Hz)

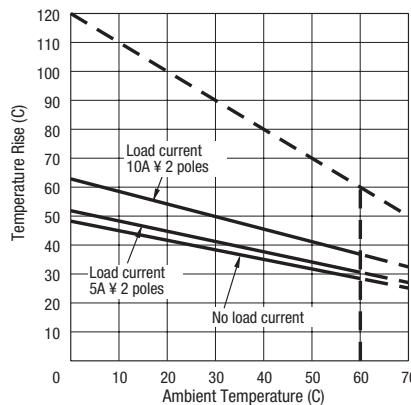

RU2 (DC Coil)

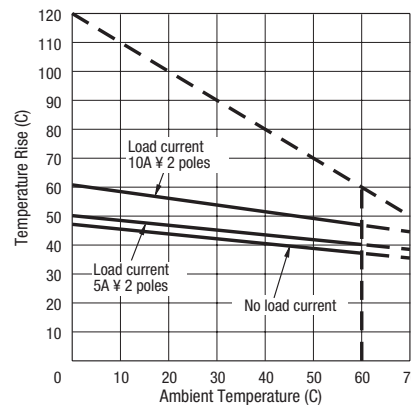

RU4/RU42 (AC Coil, 50 Hz)

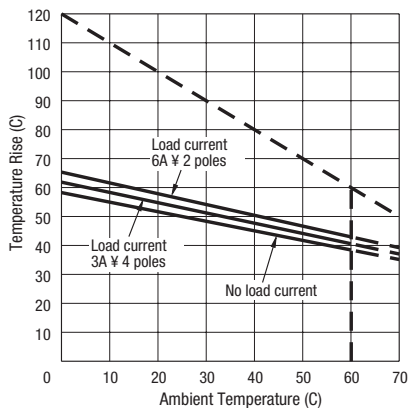

RU4/RU42 (AC Coil, 60 Hz)

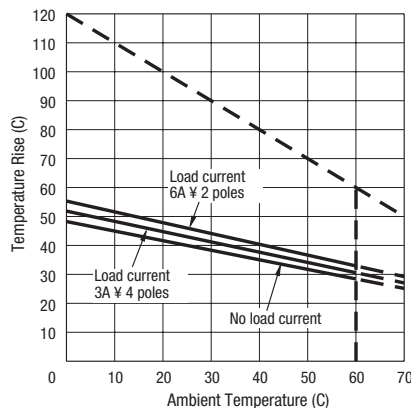

RU4/RU42 (DC Coil)

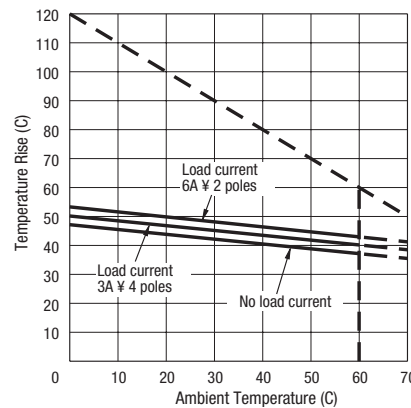

The above temperature rise curves show the characteristics when 100% the rated coil voltage is applied. The heat resistance of the coil is 120°C. The slant dashed line indicates the allowable temperature rise for the coil at different ambient temperatures. Load current 6A x 2 poles is for the RU4 models only.

Switches & Pilot Lights

Signaling Lights

Relays & Sockets

Timers

Contactors

Terminal Blocks

Circuit Breakers

Internal Connection (View from Bottom)

RU2S-* Standard

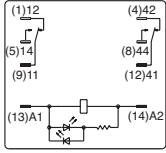

24V AC/DC coil or less

RU2S-*R with RC

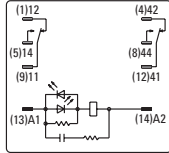

RU2S-*D With Diode

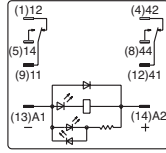

24V DC coil or less

RU2V-NF-*

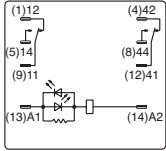
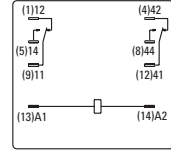

Over 24V AC/DC coil

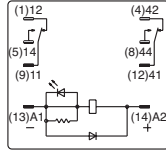

Over 24V DC coil

RU4S-*/RU42S-* Standard

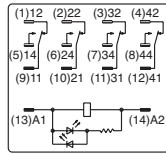

24V AC/DC coil or less

RU4S-*R/RU42S-*R With RC

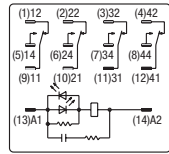

RU4S-*D/RU42S-*D With Diode

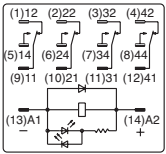

24V DC coil or less

RU4V-NF-*/RU42V-NF-*

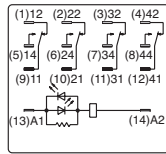
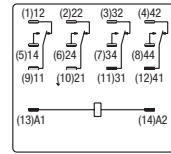

Over 24V AC/DC coil

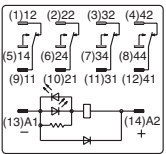

Over 24V DC coil

Dimensions (mm)

RU2S

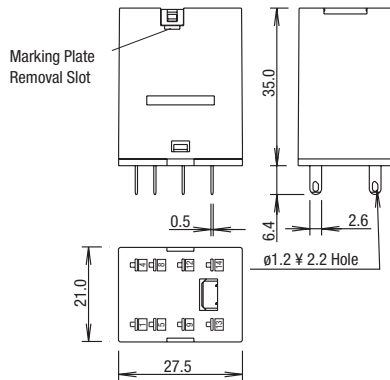

RU2V

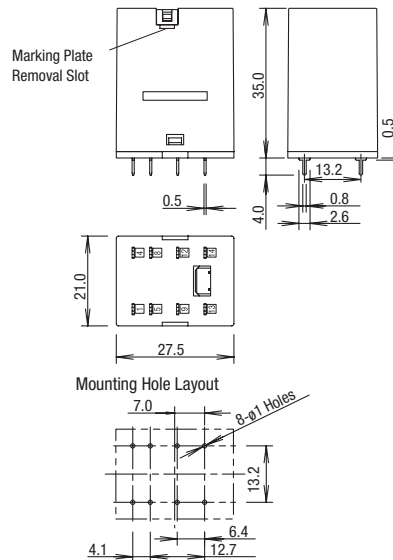

All dimensions in mm.

Dimensions con't (mm)

RU4S/RU42S

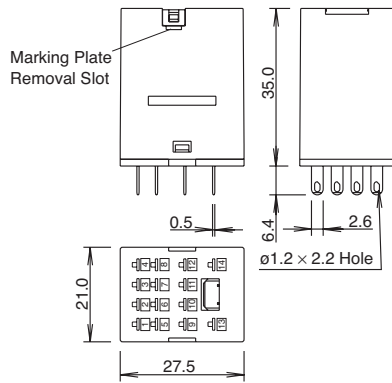

RU4V/RU42V

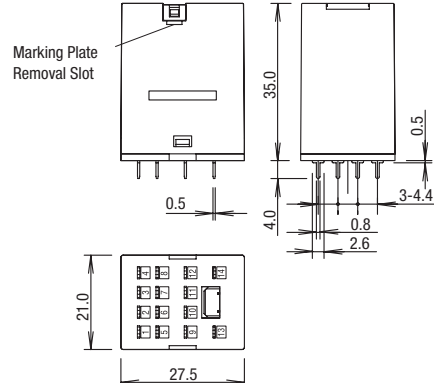

Marking plate removal slot is provided only on one side. Insert a flat screwdriver into the slot to remove the marking plate.

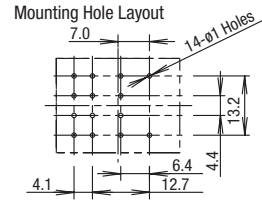

All dimensions in mm.

Spring Clamp DIN Rail Mount Sockets

SU2S-11L

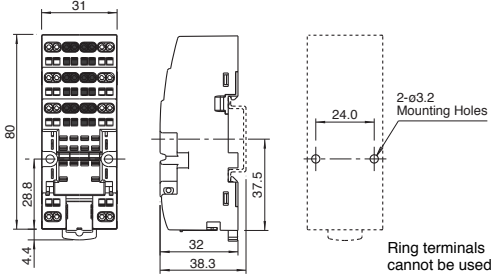

Terminal Arrangement

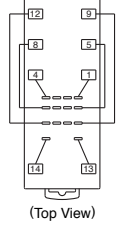

SU4S-11L

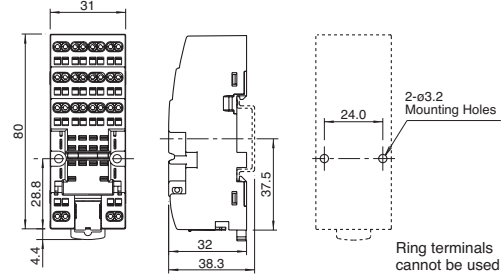

Terminal Arrangement

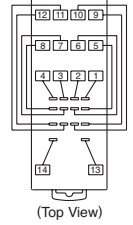

Standard DIN Rail Mount Sockets

SM2S-05

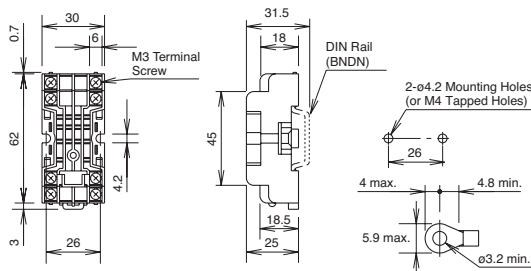

Terminal Arrangement

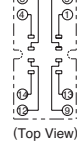

SY4S-05

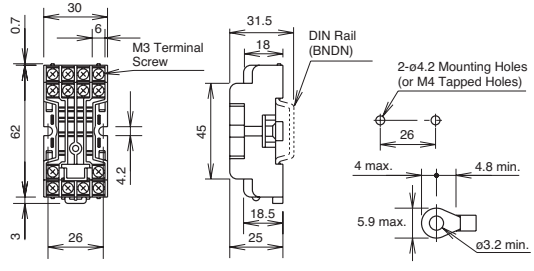

Terminal Arrangement

