



Z4D-F04A/D

Compact, High-performance Micro-displacement Sensor

- Provides resolution to 5 μm and does not require connection to microprocessor
- EE-1010D connector with 1-m cable and E39-L69 mounting bracket allows convenient, quick installation and easy maintenance
- Power and alarm indicator included in the Z4D-F04A model
- Stability/operation indicator and distance adjuster included in the Z4D-F04D model
- Numerous applications possible when the analog output model is integrated with OMRON's K3TX Intelligent Signal Processors
- ON/OFF output model (NPN open collector) is available



Ordering Information

Output	Appearance	Part number
Analog		Z4D-F04A
ON/OFF		Z4D-F04D

ACCESSORIES (ATTACHED)

Item	Z4D-F04A	Z4D-F04D	Part number
Mounting bracket	1 pc.	1 pc.	E39-L69
Mounting screws (M3 x 2)	2 pcs.	2 pcs.	—
Connector with 1-m cord	1 pc.	1 pc.	EE-1010D
Screwdriver	—	1 pc.	—
Operation Manual	1 copy	1 copy	—

Specifications

■ RATINGS/CHARACTERISTICS

Part number	Z4D-F04A	Z4D-F04D
Supply voltage	12 to 24 VDC \pm 10%, ripple voltage (p-p): 10 mV max.	
Current consumption	35 mA max.	
Sensing range (See Note 1.)	4 \pm 1.25 mm	
Light source	Red LED with a wavelength of 700 nm	
Spot diameter (See Note 2.)	1.5 x 1.5 mm max. (at the sensing range of 4 mm)	
Connection impedance (See Note 3.)	200 k Ω min.	---
Resolution (See Note 4.)	5 μ m max.	---
Hysteresis (See Note 1.)	---	40 μ m
Linearity (See Note 5.)	\pm 1% FS	---
Analog output (See Note 1.)	1 to 5 V (1.6 V/mm \pm 10%)	---
Control output	---	NPN open collector, 12 to 24 VDC, 50 mA max.
Residual output voltage	---	1 V max.
Response time (See Note 6.)	5 ms max.	1.5 ms max.
Temperature influence (See Note 7.)	0.15% FS/ $^{\circ}$ C	---
Indicator	PWR indicator (green): Lit when power is supplied ALM indicator (red): Lit when illumination is insufficient.	STB indicator (green): Lit when illumination is sufficient. OPE indicator (orange): Lit when output is ON.
Ambient temperature	Operating	-10 $^{\circ}$ C to 55 $^{\circ}$ C (14 $^{\circ}$ F to 131 $^{\circ}$ F) with no icing
	Storage	-15 $^{\circ}$ C to 60 $^{\circ}$ C (5 $^{\circ}$ F to 140 $^{\circ}$ F) with no icing
Ambient humidity	Operating	35% to 85% (with no icing)
Ambient illumination	Operating	3000 lx max. (incandescent lamp), 10,000 lx max. (sunlight)
Enclosure rating	IP50 (IEC standard)	
Vibration resistance	Destruction: 10 to 500 Hz (1-mm max. single amplitude) for 11 min for 3 times each in X, Y, and Z directions	
Shock resistance	Destruction: 500 m/s ² for 3 times each in X, Y, and Z directions (total of 18 times)	
Dielectric strength	1,000 VAC for 1 min between current carry parts and case	
Tightening torque	0.6 N \cdot m max.	
Material	ABS (Polycarbonate for the sensing part)	
Weight	Approx. 10 g (without connector cable)	
Insulation resistance	20 M Ω min. (at 500 VDC)	
Cable length	1 m	

Note: 1. The values are for N8.5 Munsell paper.

- The spot diameter is defined by $1/e^2$ of the sensor's laser beam center. Although a sub-beam may be observed around the main beam, this does not mean that the product is defective.
- Refers to input impedance of a device to be connected.
- Resolution (Z4D-F04A)
The resolution is the peak-to-peak displacement conversion value of the analog displacement output (Conditions: N8.5 Munsell mat paper at the center of measurement point with a power ripple noise of 10 mV (p-p) max.)

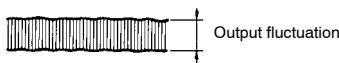

5. The value is the peak-to-peak error rate of a displacement output voltage line with N8.5 Munsell mat paper. The value varies with the sensing object.
6. Response Time (Z4D-F04A)
The response time of the sensor (Z4D-F04A) is the time required for the analog displacement output to increase from 10% to 90% of the full value (at the rise time) or decrease from 90% to 10% of the full value (at the fall time).

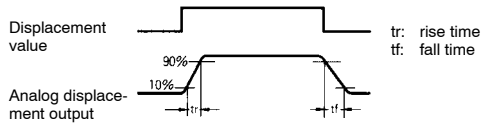

The response time of the sensor (Z4D-F04D): ON/OFF switching time

7. The value is at the sensing range of 4 mm.

■ TYPICAL APPLICATIONS

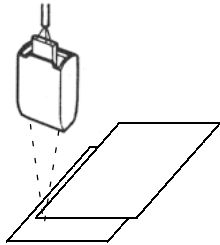

Double Feed Detection

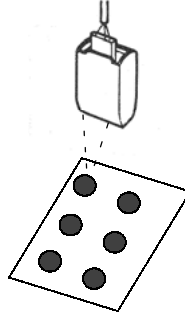

Presence/absence of small parts
or solder points

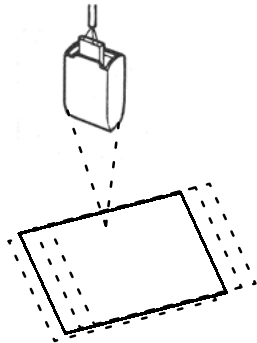

Vibration Detection

Engineering Data

ANALOG OUTPUT MODEL (Z4D-F04A)

Sensing Distance vs. Analog Output Characteristics (Typical)

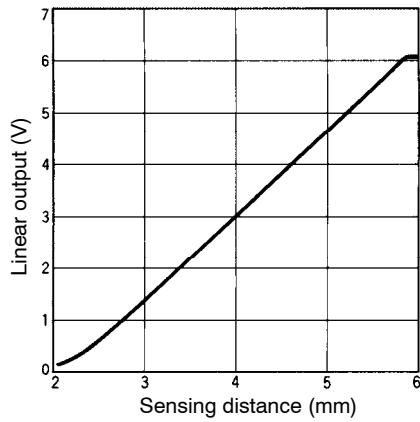

Analog Output Characteristics with Difference in Sensing Object

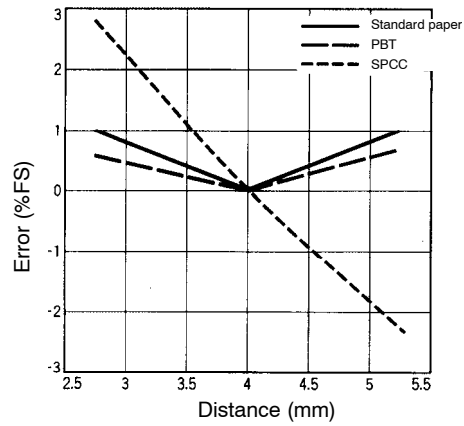

Angle Characteristics with Difference in Vertical Inclination

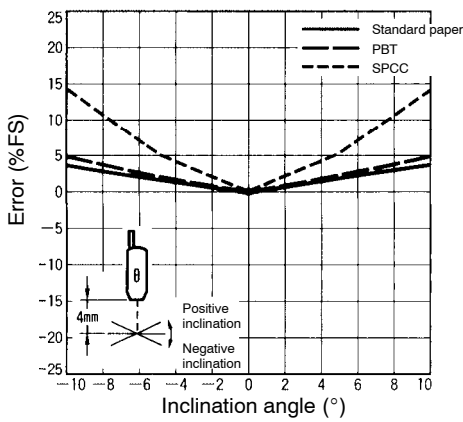

Temperature Characteristics

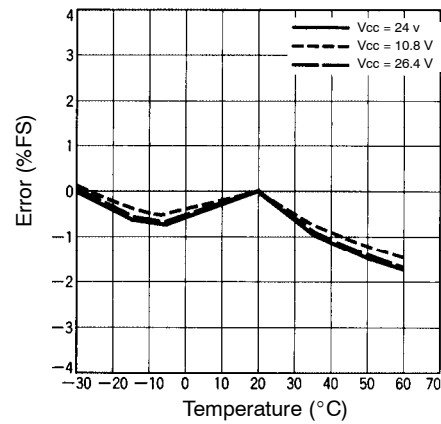

Angle Characteristics with Difference in Horizontal Inclination

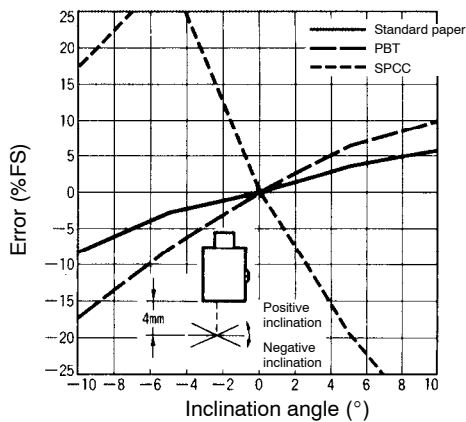

Resolution Characteristics with Difference in Reflection Rate

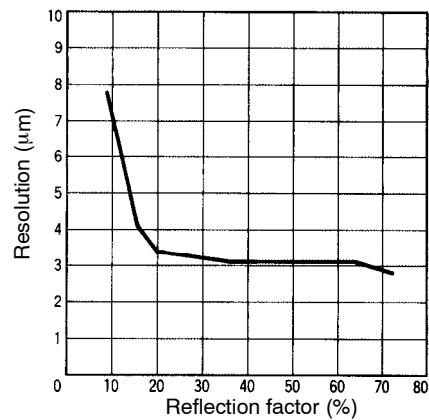

■ ON/OFF OUTPUT MODEL (Z4D-F04D)

Sensing Distance vs. Adjuster Angle Characteristics

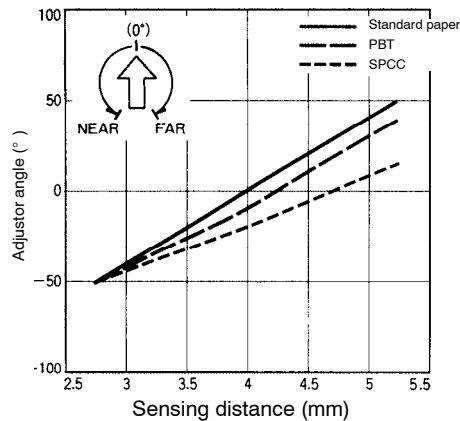

Note: The PBT plastic referred in this data was detected under its natural state.

Nomenclature

■ ANALOG OUTPUT (Z4D-F04A)

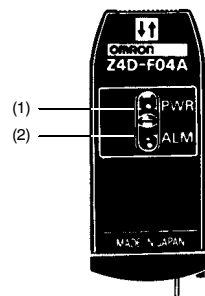

(1) Power (PWR) Indicator

The green PWR indicator is lit when power is applied to the sensor.

(2) Alarm (ALM) Indicator

The red ALM indicator is lit if no object is sensed. An object may be present, but if the reflected light is not sufficient to produce an output from the detector, the red ALM indicator will remain on. When the ALM indicator is lit, make necessary adjustments so that the indicator turns OFF.

Appropriate amount of light:	Not lit
Insufficient amount of light:	Lit in red

■ ON/OFF OUTPUT (Z4D-F04D)

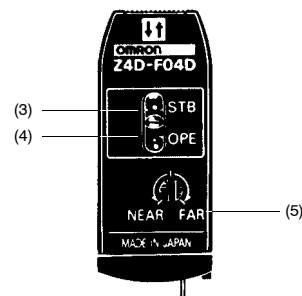

(3) Stability (STB) Indicator

The green STB indicator is lit when the sensor is receiving sufficient light to process. If the indicator is not lit, adjust the amount of light to turn on the indicator.

(4) Operation (OPE) Indicator

The sensor is synchronized with the ON/OFF output and the orange OPE indicator is lit when the sensor has ON output.

(5) Distance Adjuster

The ON/OFF position can be set with the distance adjuster if a sensing object is at the sensing range (4 ± 1.25 mm). The ON/OFF position will shift farther from the sensor if the distance adjuster is turned clockwise, and the ON/OFF position will shift closer to the sensor if the distance adjuster is turned counterclockwise.

Operation

CONNECTIONS/OUTPUT CIRCUITS

Analog Output

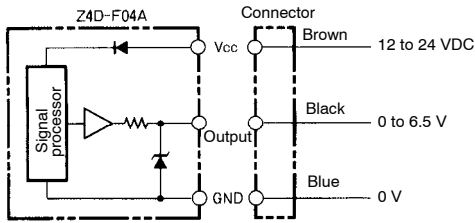

NPN Open Collector Output

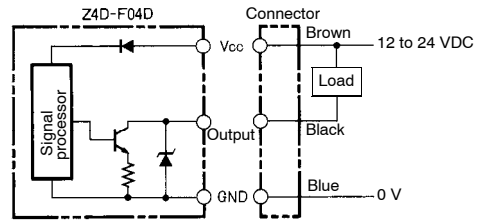

Dimensions

Unit: mm (inch)

Z4D-F04A

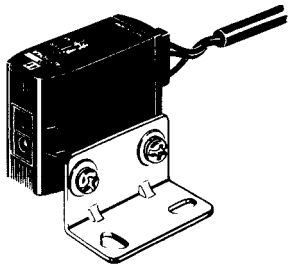

Mounting bracket can be attached to this side.

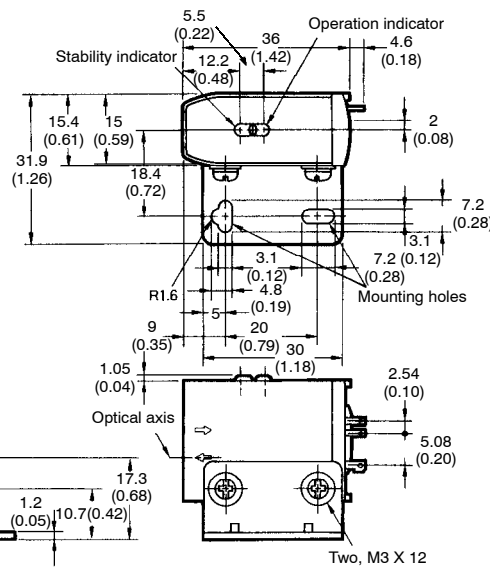
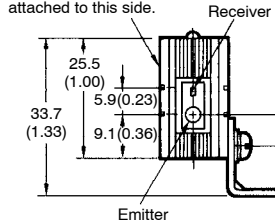

Mounting Holes

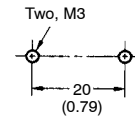

Z4D-F04D

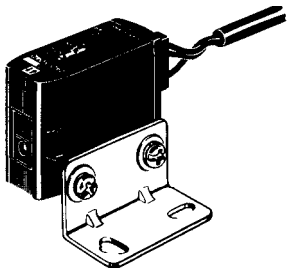

Mounting bracket can be attached to this side.

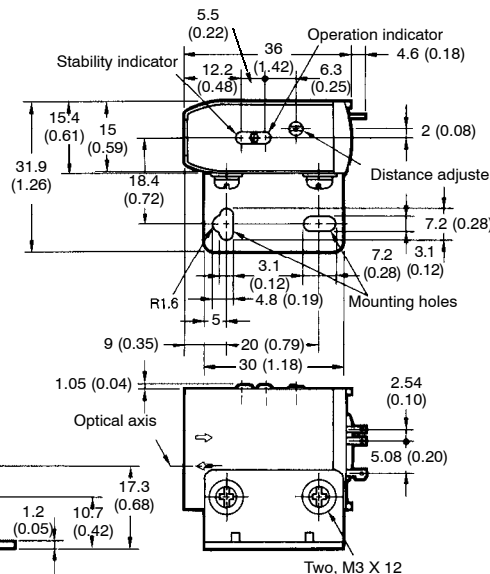
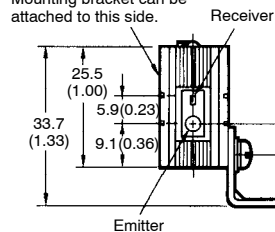

Mounting Holes

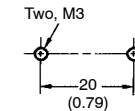

■ ACCESSORIES

The following products are provided with the sensors. The products can also be purchased separately.

E39-L69 Mounting Bracket

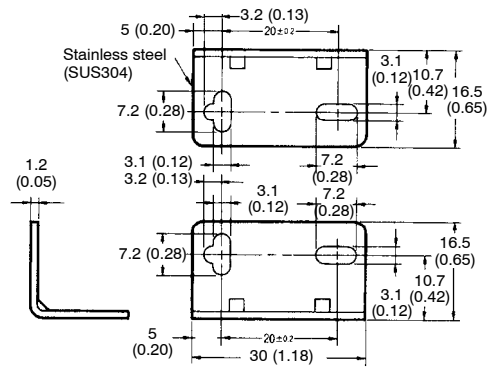
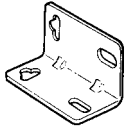

EE-1010D Connector with 1-m Cable

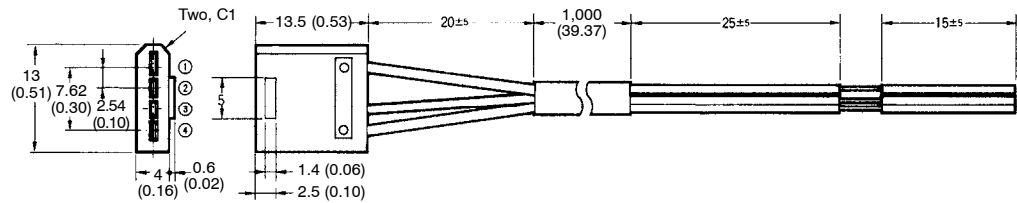

Terminal Arrangement

No.	Designation	Color
1	Vcc	Brown (red)
2	---	---
3	Output	Black (white)
4	GND	Blue (black)

Note: Older standard colors are shown in parenthesis.

Installation

■ CONTROLLER CONNECTIONS

Z4D-F04A and K3TX-VD

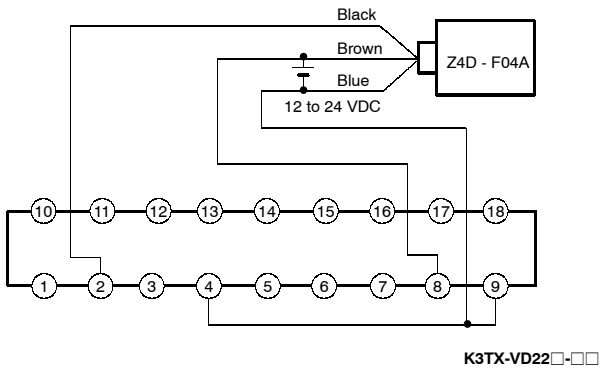

- Note:
1. Use a K3TX DC voltage input model.
 2. K3TX models are available in various output units. Select the most appropriate K3TX model depending on the application.
 3. For details about the K3TX, refer to the *K3TX Data-sheet*.
 4. The diagram shown here is for a K3TX model with DC power specifications. When using a K3TX with AC power specifications, separate the AC power supply to the K3TX from the DC power supply to the Z4D-F04A.

Z4D-F04D and S3D2

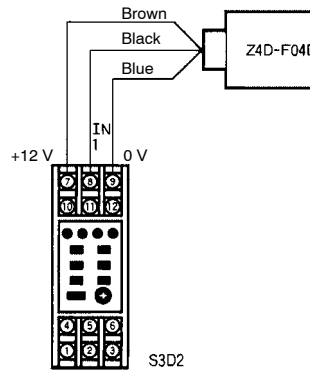

- Note: Reverse operation is possible with the signal input selector of the S3D2.

⚠ Caution

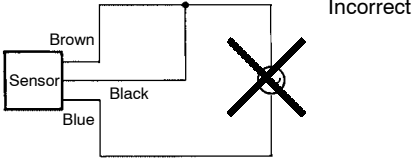
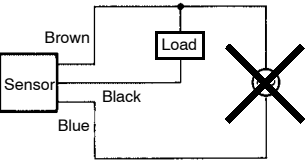
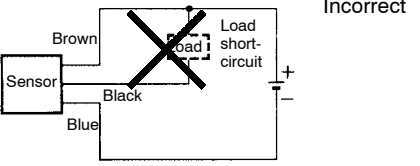
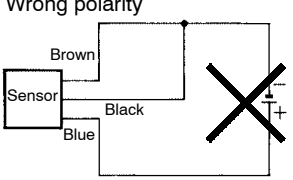
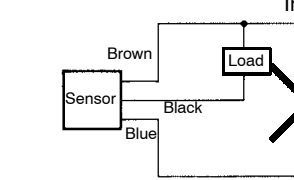
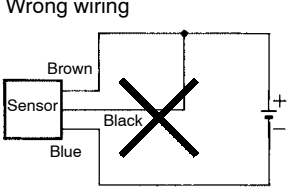
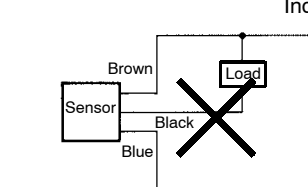
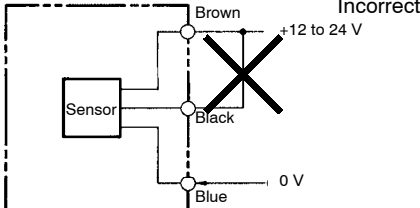
Item	Examples	
<p>Power supply Do not exceed the maximum specified voltage applied to the Z4D, or it may explode or burn. Do not impose 100 VAC on any Z4D-F model; or it may explode or burn.</p>		
<p>Load short-circuit Do not short-circuit the load, or the Z4D-F may explode or burn.</p>		
<p>Wiring Be sure to wire the Z4D-F correctly and be careful not to connect the polarities incorrectly. Failure to wire the Z4D-F correctly can result in safety hazards or damage to the equipment.</p>	<p>Wrong polarity Incorrect</p> 	<p>Wrong polarity Incorrect</p> 
	<p>Wrong wiring Incorrect</p> 	<p>Wrong wiring Incorrect</p> 
<p>Connection with no load If connected to the power supply without any load, internal elements may explode or burn. Make sure to connect a proper load to the Z4D-F.</p>	<p>Incorrect</p> 	

■ CORRECT USE

Mounting

Install the sensor so that the optical axis of the sensor and the surface of the sensed object meet at right angles (i.e., the panel that incorporates the light source is parallel with the object). For accurate results, it is recommended that the sensing distance is set to the measurement point (4 mm).

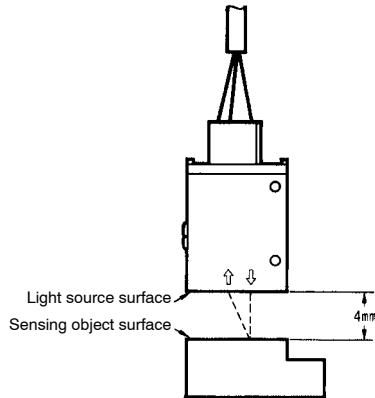

Note: As the optical axis will be adjusted later, temporarily fix the sensor.

Wiring

Connect the sensor to the controlling device using an attached sensor cable. DO NOT SWITCH THE POWER ON DURING WIRING. Refer to the instructions on the sensor and the connection diagram before connecting the sensor to the controlling device.

Axis Adjustment

When the sensor power is switched ON, the red transmitter indicator is lit. Move the sensor so that the red beam (see the figure below) focuses on the object. The entire light beam should be focused on the object or an error will result.

After the optical axis has been adjusted, tighten the mounting screws firmly.

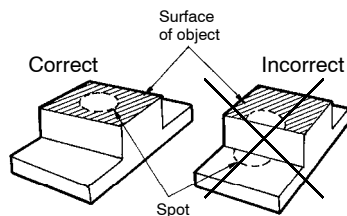

Z4D-F04A

Analog Output

The Z4D-F04A has an output of 3 V if a sensing object is located at the standard distance (i.e., 4 ± 0.3 mm). The output decreases if the sensing object is closer to the sensor and the output increases if the sensing object is farther from the sensor. The output changes by $1.6 \text{ V} \pm 10\%$ if the sensing object moves by 1 mm. The standard upper and lower limits of the output are 6.5 and 0 V respectively. If there is no sensing object or the reflectivity of the sensing object is low, the resulting analog output will be the standard upper limit.

Analog Output Diagram

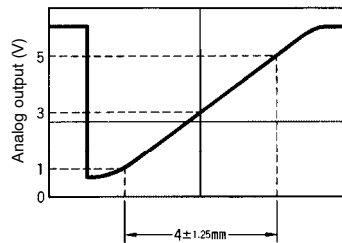

Z4D-F04D

ON/OFF Output Diagram

The ON/OFF position can be set with the distance adjuster if a sensing object is at the sensing range (i.e., 4 ± 1.25 mm). The ON/OFF position will shift farther from the sensor if the distance adjuster is turned clockwise, and the ON/OFF position will shift closer to the sensor if the distance adjuster is turned counterclockwise.

If no sensing object is present or if the reflectivity from a sensing object is too small to reach the sensor, the output will turn OFF.

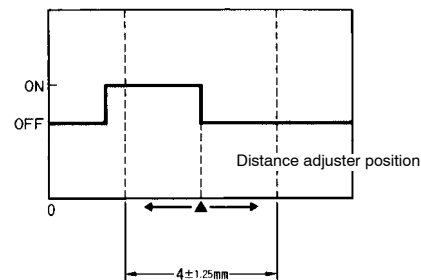

Precautions

Install the sensor in a clean environment. Keep the filter (on the front of the sensor) free from oil and dust. If affected by oil or dust, clean the sensor as follows:

1. Use a blower brush (used to clean camera lenses) to blow large dust particles from the surface. Do not blow the dust away with your mouth.
2. Use a soft cloth (for lenses) with a little alcohol to remove the remaining dust. Do not use a scrubbing action when cleaning. A scratch on the filter could result in the sensor malfunctioning.

CONNECTOR

When removing the connector from the sensor, be sure to hold the connector and pull it along with the attached cable.

If pressure is applied to the cable alone, it will damage the lock mechanism inside the connector.

INTERFERENCE

Z4D-F04A/D microdisplacement sensors can be installed within close proximity to each other and operate independently without interference (refer to the figures below). However, if they are installed at an oblique angle to each other, interference may result.

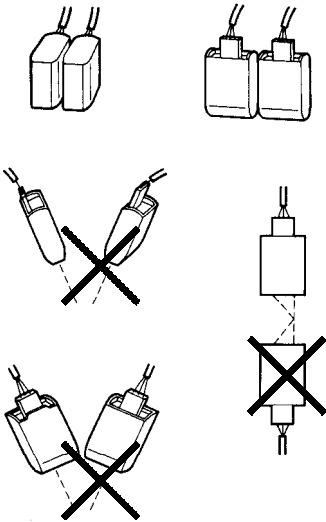

When using the microdisplacement sensor in combination with another type of sensor (such as a photoelectric sensor), the sensor beams should be as close to perpendicular as possible.

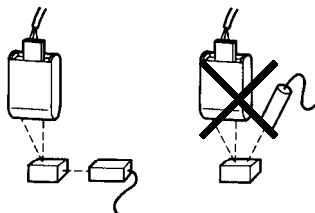

ENVIRONMENT

Refrain from using the microdisplacement sensor in a strong electromagnetic field or in an environment where the operation of the sensor is subject to the reflection of intensive light (such as a laser beam or an electric arc welding machine).

The microdisplacement sensor cannot accurately sense a mirror-like object, a transparent object, one with an extremely small reflection ratio, an object smaller than the diameter of the sensor's sensing spot, or an inclined object.

WIRING

The power supply cable for the Z4D-F04A/D should not be wired with high-voltage lines or power lines in order to avoid interference, damage, or malfunction.

Do not solder wires to the sensor connector, or the sensor may malfunction.

OTHERS

Do not use switching power supplies that generate excessive noise, which may cause sensing errors.

The following LC filter effectively reduces noise.

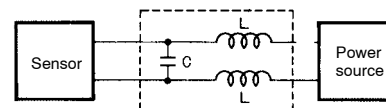

The sensor cannot sense an object accurately if the surface of the object consists of different materials placed next to each other (refer to the figures below). In such a case install the sensor so that the boundaries of the materials and the sensor are parallel.

