

LED FLEX RIBBON JOINER CONNECTOR

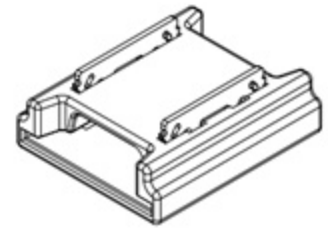

- MATES WITH JKL ZFS-10 SERIES, SINGLE COLOR 12V AND 24V LED RIBBONS
- ALLOWS TWO SECTIONS OF RIBBON TO BE JOINED

PARAMETER	RATING
MAX CURRENT	6 AMPS
OPERATING TEMPERATURE	-30° ~+80°C
INGRESS PROTECTION	IP20 (not water resistant)

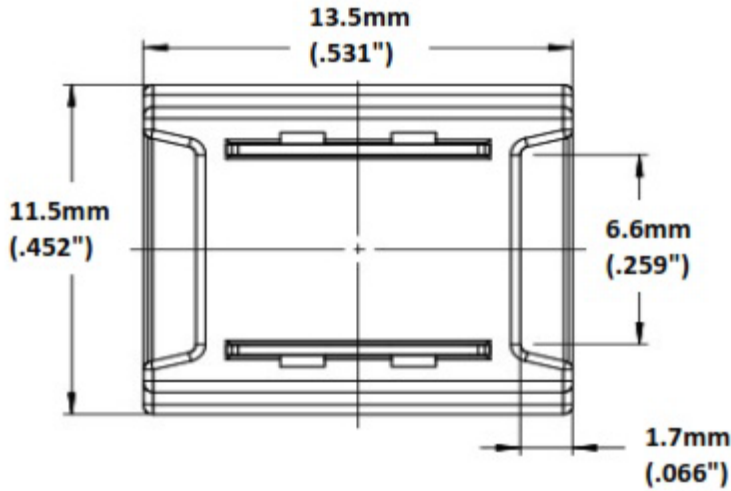
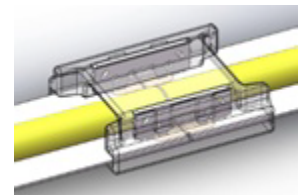
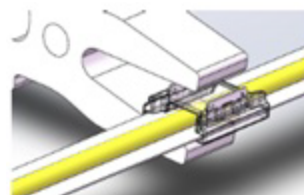
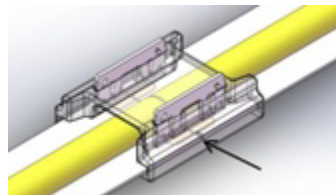
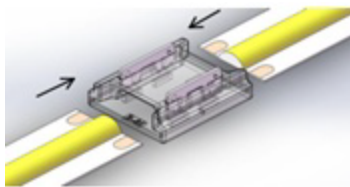

1. Peel small section of backside tape before inserting LED flex into connector. The inserted portion should be without tape.
2. Both sides of LED flex ribbon should be completely pushed in as shown.

3. Use pliers to clamp each terminal down to the level of the plastic body. Clamp one side and then the other.

4. Finished.
Note: After clamping the terminals, they will not be completely flush with the plastic and can sit 0.15mm higher than the plastic body.

With connector terminals facing up, insert LED ribbon into each side. The positive (+) markings on the LED flex ribbon should both be on the same side.

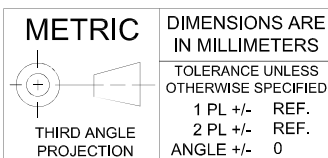

JKL COMPONENTS CORPORATION

TITLE
10MM LED FLEX RIBBON JOINER CONNECTOR

DRAWN BY
S.Newton

APPVD BY DATE
S.N. 5/16/22

SIZE
A

FSCM NO.
55335

DRAWING NO.
ZFS-CH-10J

RELEASED 5/16/22

REV. NO. DESCRIPTION/ECO NUMBER APPVD DATE

MANUAL REVISIONS NOT PERMITTED

SCALE
NONE

RELEASED DATE
5/16/22

REVISION DATE

REV. NO.

SHEET
1 OF 1