

For In Rush Current Limitation

How they work

In-rush current limitation requires a high level of reliability. In these applications, the Posi-R is used in switch parts and parallel connection. When the power circuit is turned on and in-rush current is applied to the Posi-R, this current is quickly contained, thus protecting the secondary electronic equipment. Even during irregularities of continuous application of voltage, the Posi-R provides stability and safety by ensuring a constant temperature.

Example of circuits used in

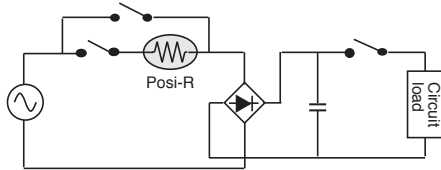

Features

- Unlike cement resistors, these thermistors will not melt or short even when voltage is continuously applied after a switch part breaks down.
- Space efficient
- Because the thermistors have recovery properties, they can withstand continuous use.

Case type

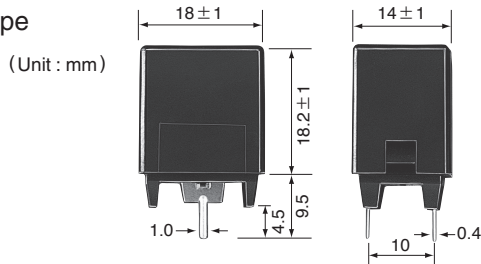

Type No.	Initial Resistance (at 25°C)	Max. Operating Voltage (Vrms)
ZPM0RCH330A250	33 Ω ±25%	276
ZPR0RCH400A250	40 Ω ±25%	
ZPR0RCH660A250	66 Ω ±25%	
ZPR0RCH750A250	75 Ω ±25%	
ZPR0RCE820A250	82 Ω ±25%	
ZPR0RCE101A250	100 Ω ±25%	

[Voltage application time and product temperature]

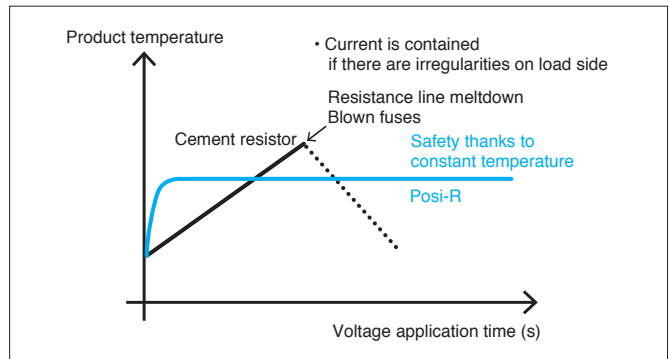

Compared to cement resistors, will not rise in temperature even under continuous current flow.

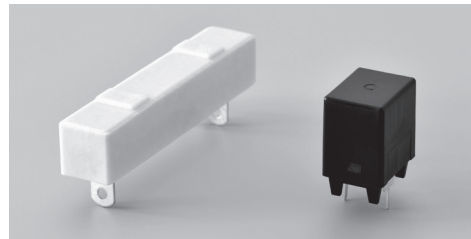

More space efficient than cement resistors

Lead type

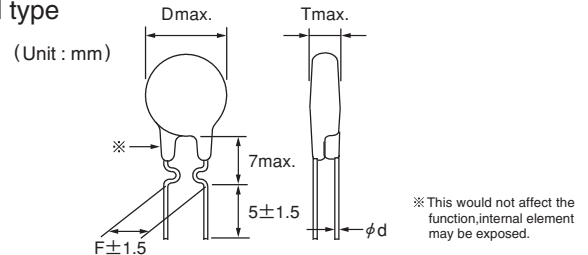

Type No.	Initial Resistance (at 25°C)	Max. Operating Voltage (Vrms)	Dimensions (mm)			
			D	T	F	d
ZPC54CH121	120 Ω ±25%	276	7.8	6	5.0	0.5
ZPC54CH181	180 Ω ±25%		7.8	6	5.0	0.5
ZPC5JCG121	120 Ω ±25%		15	6	10.0	0.6

For inquiries regarding part number selection, etc., please contact your local authorized distributor with the required specifications and annual usage quantities.



APPLICATION GUIDELINES

General Observations

1. Do not use "Posi-R" in the presence of oil or water. The parts could fail.
2. Do not apply voltage in excess of the maximum operating voltage. This could cause a short circuit or burn-out.
3. Do not use "Posi-R" with reactive gas, reducing gas, or oxygen-free environment-electrical characteristics may deteriorate or burn-out may occur.

Notes on Usage

1. Please use the parts within the rated operating temperatures according to the catalog.
2. Please use at maximum operating voltage as specified in the catalog.
3. The surface temperature during operation of "Posi-R" is 100 to 160°C. Please take into consideration the effect of generated heat around the "Posi-R"
4. Excessive press or shock (ex. drop) should not be applied to the "Posi-R".

5. Do not apply more lead stress than specified.
6. Do not allow flux to come in contact with "Posi-R", it may cause failure.
7. The outer resin on the leads may be partially peeled off. This will not affect the function of products.
8. In case of gluing "Posi-R", the outer resin may be come off, please contact us in this case.

Notes on Storage

1. Packaged parts should be stored under the following conditions :
temperature : -10 to +40°C
humidity : 85% or less
2. Storage of "Posi-R" devices may result in increased resistive characteristics. They will return to the initial value by applying max. operating voltage prior to using the parts.
3. Shall be used shortly after opening the package. The prolonged exposure to the air may case to deteriorate the solderability.

■ Lead Shape

【Bulk】

【Taping】

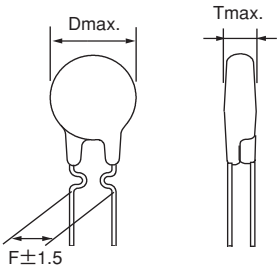

(Unit : mm)

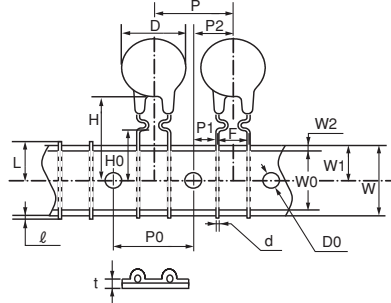

Formed lead type (U)
(Less φ12)

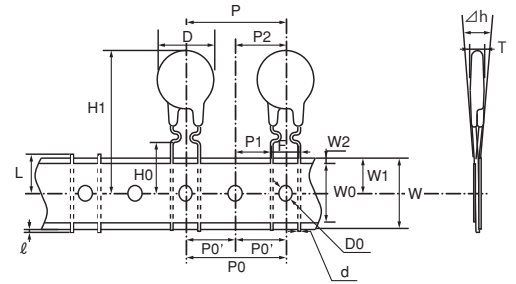

Formed lead type (U)
(Above φ12)

Item	Symbol	Dimensions (mm)			Note
		Nominal		Tolerance	
Diameter	D	Less φ12	Above φ12	—	Subject to part DWG
Thickness	T	—	—	—	Subject to part DWG
Lead dia	d	—	—	—	Subject to part DWG
Pitch of component	P	12.7	25.4	± 1.0	
Feed hole pitch	P0	12.7	25.4	± 0.3	
Hole center to lead	P1	3.85	7.7	± 0.7	
Feed hole center to component center	P2	6.35	12.7	± 1.3	
Lead to lead distance	F	5.0	10.0	$\begin{matrix} +0.8 \\ -0.2 \end{matrix} \quad \pm 0.8$	
Tilt of component	Δh	0		± 2.0	
Tape width	W	18.0		$\begin{matrix} +1.0 \\ -0.5 \end{matrix}$	
Hold down tape width	W0	12.5		min.	
Slip out of hole	W1	9.0		$\begin{matrix} +0.75 \\ -0.5 \end{matrix}$	
Slip out of hole down tape	W2	3.0		max.	
Height of component from tape center	H	—		—	Subject to part DWG
Lead wire clinch height	H0	16.0		± 0.5	
Length of cut lead	ℓ	1.0		max.	
Feed hole diameter	φD0	4.0		± 0.2	
Total tape thickness	t	0.6		± 0.3	
Cut length of rejected component	L	11.0		max.	

【Taping specification packaging example】

(Ammo-pack)

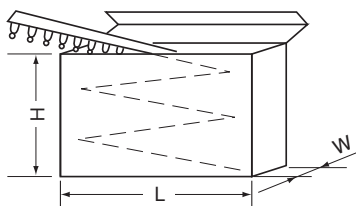

Symbol	Dimension (mm)
H	230
L	330
W	50

For Overcurrent Protection

- Specifications Rated Voltage : 12 to 220V
Resistance : 0.3 to 1kΩ

Resistance value changes at rated voltage

■ How they work

The Posi-R for overcurrent protection must be able to withstand repeated operation. The Posi-R controls the element and thus contains the current. As a result the current can be contained repeatedly after the current value returns to normal. The Posi-R is thus superior to fuses and polymer-based PTC's. A fuse will "blow" when exposed to irregular current and is no longer useful. Polymer-based PTC, will change usage conditions the more it is used.

【Example of circuits used in】

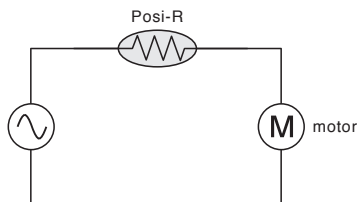

【Current-Time properties】

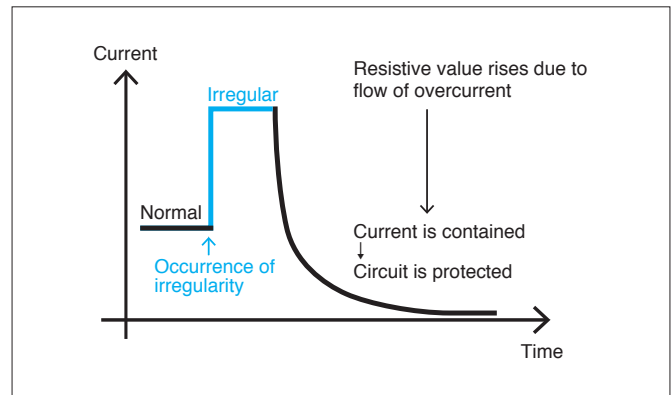

Current is contained in case of irregularity and circuit is thus protected.

■ Record on the market

Posi-R is mainly used to protect small motors for in-vehicle applications (door mirrors, door locks, etc.), where products must withstand repeated use; and in air conditioner circuits (inverter control circuit boards, outdoor unit fan motors, etc.).

■ Features

- Ability to withstand repeated use means there's no need to replace it like with fuses.
- Offers superior repeated use since it's non contact.
- Usage conditions won't change even after repeated usage.
- No faulty operation due to noise.

■ Part Number

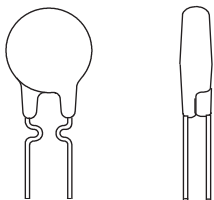

Rated Voltage	Initial Resistance (at 25°C)	max. Operating Voltage (V)	Current Characteristic (mA)	
			Normal Current (60°C)	Limiting Current (-10°C)
12V class	0.3 to 2.2	16	≦ 300 to ≦ 1030	760 ≦ to 2580 ≦
25V class	2.2 to 8.2	35	≦ 120 to ≦ 400	310 ≦ to 1020 ≦
50V class	3.6 to 15	60	≦ 130 to ≦ 310	320 ≦ to 790 ≦
120, 220V class	10 to 30	140	≦ 100 to ≦ 210	250 ≦ to 540 ≦
	27 to 39	265	≦ 70 to ≦ 140	180 ≦ to 350 ≦

Representative product number

	Type No.	Initial Resistance (at 25°C)	max. Operating Voltage (V)	max. Inrush Current (A)	Current Characteristic (mA)		Dimensions (mm)			
					Normal Current (60°C)	Limiting Current (-10°C)	D	T	F	d
12V class	ZPC11CE2R2	2.2Ω ±20%	16	2.1	≦ 300	760 ≦	5.5	3.0	5.0	0.5
	ZPC13CE1R5	1.5Ω ±20%	16	3.0	≦ 410	1030 ≦	7.0	3.0	5.0	0.6
25V class	ZPC2ECE3R3	3.3Ω ±20%	35	2.2	≦ 310	790 ≦	11.9	3.5	5.0	0.6
	ZPC2LCE2R2	2.2Ω ±20%	35	2.8	≦ 400	1020 ≦	14.3	3.5	10.0	0.6
220V class	ZPC56CE390	39Ω ±20%	265	0.8	≦ 70	180 ≦	9.5	5.5	5.0	0.6

Resistance and current values not listed in the catalog may be available. Please contact your local authorized distributor with the required specifications and annual usage quantity.

■ Application Manual

When something abnormal occurs at the load such as a transistor circuit or a small-type motor, an abnormal current rushes into the power source circuit. Then, a power transistor at the transformer or the switching power supply generates heat in an abnormal level and causes breakdown.

If a Posi-R for overcurrent protection is used in such a circuit, it can make the temperature compensation and protection for the power source and the load. An example is as shown in the figure on the right.

As to the temperature protection, it can be perfectly made in use of this Posi-R owing to the excellent characteristics of resistance anomaly, that is, a current is reduced by the increased resistance due to the selfheating of Posi-R.

At the current/voltage characteristics in Fig. 2, there is a peak current. If a current larger than this peak current flows, a Posi-R acts. But if a current less than the peak current flows, a Posi-R does not act. The peak current varies depending upon the size of Posi-R, resistance and ambient temperature. Fig. 1 shows an example of current characteristics.

At the current higher than the upper limit of fluctuation range, a Posi-R acts. Contrary, at the current less than the lower limit, it does not act. But the fluctuation range varies owing to ambient temperature.

For instance, if the operating temperature range is supposed to be at -10 to +60°C, the lower limit at +60°C becomes the maximum value for a normal current (non-acting) and the upper limit at -10°C becomes the minimum value for a limiting current (acting), respectively.

Judging from the above explained relations, a Posi-R can be suited for the circuit where the ratio of a limiting current to a normal current is more than 2.5 to 3 times.

【Examples of applications】

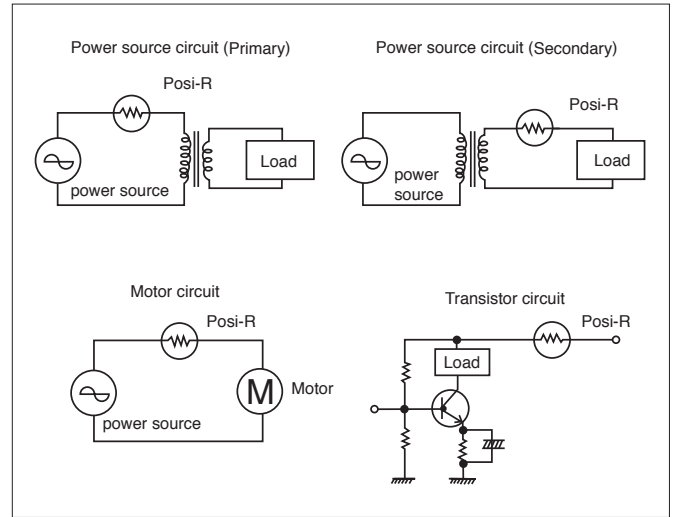

【Characteristic Example】

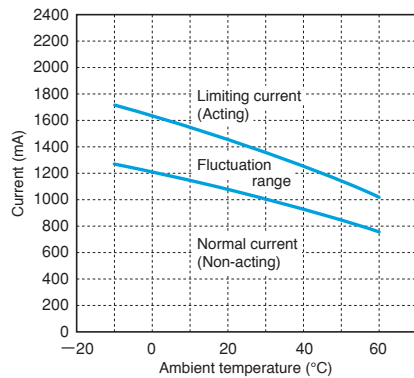

Fig. 1 Current Characteristics

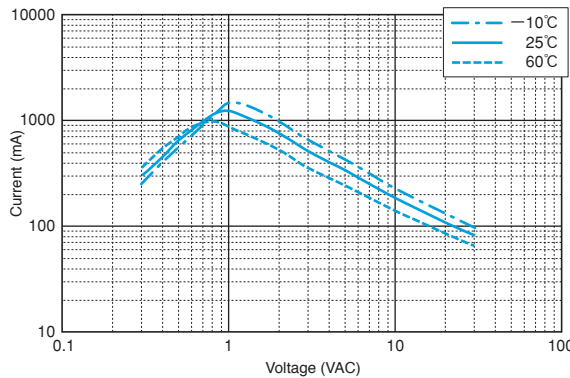

Fig. 2 Current / Voltage Characteristics

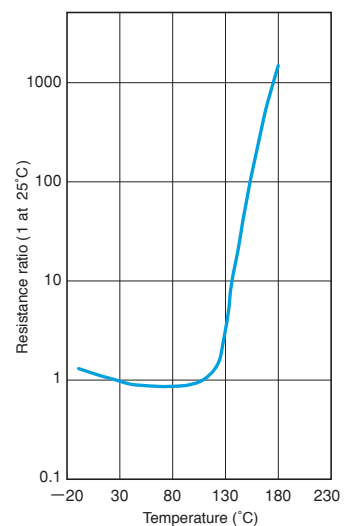

Fig. 3 Resistance / Temperature Characteristics



APPLICATION GUIDELINES

General Observations

1. Do not use "Posi-R" in the presence of oil or water. The parts could fail.
2. Do not apply voltage in excess of the maximum operating voltage. This could cause a short circuit or burn-out.
3. Do not use "Posi-R" with reactive gas, reducing gas, or oxygen-free environment-electrical characteristics may deteriorate or burn-out may occur.

Notes on Usage

1. Please use the parts within the rated operating temperatures according to the catalog.
2. Please use at maximum operating voltage as specified in the catalog.
3. The surface temperatures for the "Posi-R" during operation are: for overcurrent protection 100 to 160°C. Please take into consideration the effect of generated heat around the "Posi-R".

4. Excessive press or shock (ex. drop) should not be applied to the "Posi-R".
5. Do not apply more lead stress than specified.
6. Do not allow flux to come in contact with "Posi-R", it may cause failure.
7. The outer resin on the leads may be partially peeled off. This will not affect the function of products.
8. In case of gluing "Posi-R", the outer resin may be come off, please contact us in this case.

Notes on Storage

1. Packaged parts should be stored under the following conditions: temperature : -10 to +40°C, humidity :85% or less
2. Storage of "Posi-R" devices may result in increased resistive characteristics. They will return to the initial value by applying max. operating voltage prior to using the parts.
3. Shall be used shortly after opening the package. The prolonged exposure to the air may case to deteriorate the solderability.

■ Lead Shape

【Bulk】

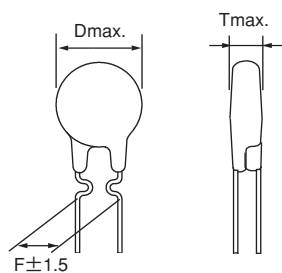

(Unit : mm)

【Taping】

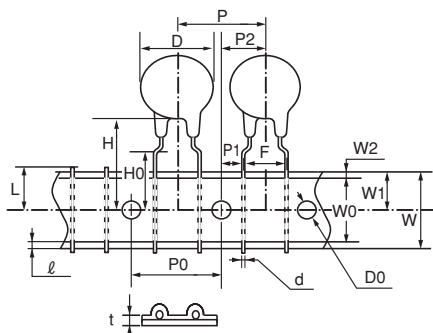

Formed lead type (Y)

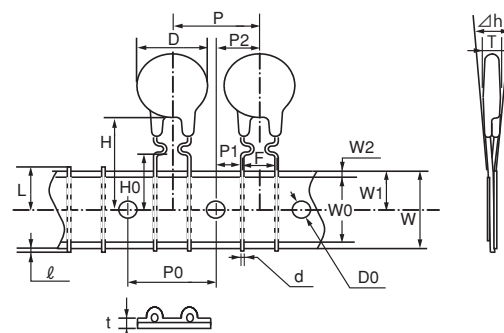

Formed lead type (U)

Item	Symbol	Dimensions (mm)		Note
		Nominal	Tolerance	
Diameter	D	Less $\phi 12$	—	Subject to part DWG
Thickness	T	—	—	Subject to part DWG
Lead dia	d	—	—	Subject to part DWG
Pitch of component	P	12.7	± 1.0	
Feed hole pitch	P0	12.7	± 0.3	
Hole center to lead	P1	3.85	± 0.7	
Feed hole center to component center	P2	6.35	± 1.3	
Lead to lead distance	F	5.0	+0.8 -0.2	
Tilt of component	Δh	0	± 2.0	
Tape width	W	18.0	+1.0 -0.5	
Hold down tape width	W0	12.5	min.	
Slip out of hole	W1	9.0	+0.75 -0.5	
Slip out of hole down tape	W2	3.0	max.	
Height of component from tape center	H	—	—	Subject to part DWG
Lead wire clinch height	H0	16.0	± 0.5	
Length of cut lead	l	1.0	max.	
Feed hole diameter	$\phi D0$	4.0	± 0.2	
Total tape thickness	t	0.6	± 0.3	
Cut length of rejected component	L	11.0	max.	

【Taping specification packaging example】

(Ammo - pack)

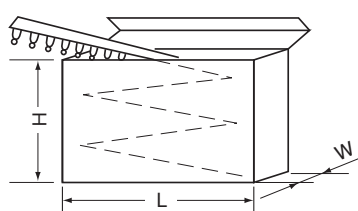

Symbol	Dimension (mm)
H	230
L	330
W	50

For Heater

- Specifications Rated Voltage : 12 to 220V
Resistance : 0.5 to 2kΩ

Resistance value changes at rated voltage

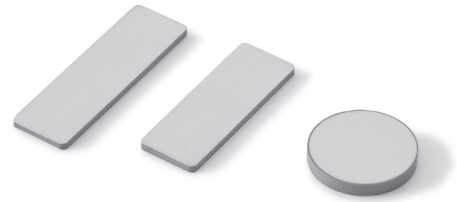

■ How they work

Thermistors for heaters require safety and power saving performance. The Posi-R quickly heats up when current flows through it. The Posi-R reaches the heating temperature evenly throughout its entire structure. The heating temperature can be controlled by adjusting the construction of Posi-R's material make-up. In addition, because Posi-R maintains a constant temperature thanks to a balance between heat generation and heat dissipation, it will not exceed the heating temperature.

【Current-Time properties】

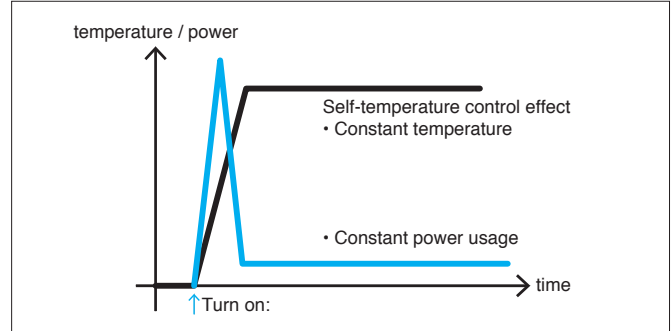

Temperature quickly rises, and temperature and power usage are constant.

■ Features

- Quickly heats up to desired temperature.
- Its temperature is uniform and never gets red hot, making it very safe.
- Posi-R's self-temperature-control effect prevents excessive heating.

- The Posi-R's self-temperature-control function ensures power savings.
- Users can select their desired temperatures.

■ Element

A disc type Posi-R is ideal for a small-power heater, making use of its self-heating and self-equilibrium characteristics. As a Posi-R self-heats when voltage is applied, the size of a heater element and the switching temperature can be optionally selected in accordance with the shape of appliances. Since this is of a non-contact control type, it is highly reliable for such applications. It is used for a Automobile-related appliances, house hold appliances and business machines.

Rated Voltage	Resistance	Switching temperature
12V class	0.5 to 3.0Ω	260℃ or less
100V class	100 to 2000Ω	
200V class	200 to 2000Ω	

Resistance varies with size and Curie point.

※ When considering evaluation, please contact your local authorized distributor along with required specifications and annual usage quantities.

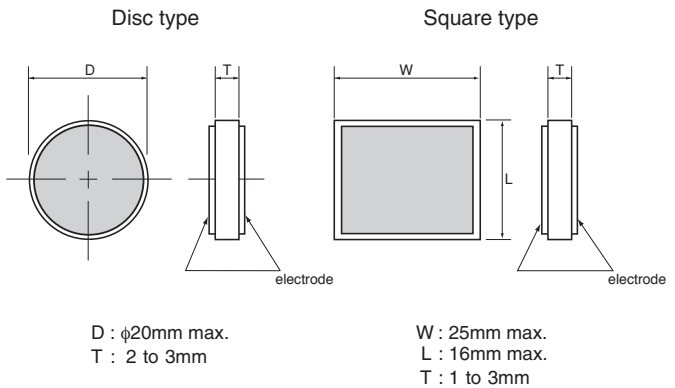

APPLICATION GUIDELINES

General Observations

1. Do not use "Posi-R" in the presence of oil or water. The parts could fail.
2. Do not apply voltage in excess of the maximum operating voltage. This could cause a short circuit or burn-out.
3. Do not use "Posi-R" with reactive gas, reducing gas, or oxygen-free environment-electrical characteristics may deteriorate or burn-out may occur.

2. Please use at maximum operating voltage as specified in the catalog.
3. Excessive press or shock (ex. drop) should not be applied to the "Posi-R".

Notes on Storage

1. Packaged parts should be stored under the following conditions : temperature : -10 to +40℃, humidity :85% or less
2. Storage of "Posi-R" devices may result in increased resistive characteristics. They will return to the initial value by applying rated voltage prior to using the parts.
3. Shall be used shortly after opening the package.

Notes on Usage

1. Please use the parts within the rated operating temperatures according to the catalog.