

# Slim Industrial Relay Type RSLM Electromechanical



- Slim size (width 5mm)
- High breakdown voltage 4kV (between coil and contacts)
- Surge voltage up to 6kV (between coil and contacts)
- Conforms to VDE 0700, 0631 reinforced insulation
- High sensitivity: Approx. 170mW
- RoHS compliant
- Dimensions: 28.0 x 5.0 x 15.0mm
- Changeover contact (SPDT) or Normally Open (SPST) contact configuration option

## Product Description

The RSLM is a very slim electromechanical relay that can switch resistive loads with a maximum switching current of 6A. It is available with 1 changeover contact (SPDT) or 1 normally open (SPST) contact.

The RSLM is suitable for use with PLCs, valves actuation or solenoids. The DIN rail installation of the RSLM relays on DIN rail, while the ZRLP enable easy installation on PCB.

## Approvals



## Ordering Key

**RSL M 001 024**

Model \_\_\_\_\_  
 Type (Electro-mechanical) \_\_\_\_\_  
 Contact configuration \_\_\_\_\_  
 Nominal coil voltage \_\_\_\_\_

## Type Selection

Contact Configuration	Contact Rating	Contact Code
1 change over contact (SPDT - 1)	6A, 250VAC/30VDC	001
1 normally open contact (SPST - 1)	6A, 250VAC/30VDC	100

## Selection Guide

Part Number	Max. switching current	Nominal Voltage	Contact Configuration
RSLM100012	6A	12VDC	SPST
RSLM001012			SPDT
RSLM100024		24VDC	SPST
RSLM001024			SPDT
RSLM100048		48VDC	SPST
RSLM001048			SPDT
RSLM100060		60VDC	SPST
RSLM001060			SPDT

## Coil Characteristics DC @ +23°C

Nominal Voltage (VDC)	Pick-up Voltage VDC max	Drop-out Voltage VDC min.	Max Voltage VDC <sup>1)</sup>	Coil Resistance Ω
12	9.0	0.60	18	848 x (1±10%)
24	18.0	1.20	36	3390 x (1±15%)
48	36.0	2.40	72	10600 x (1±15%)
60	45.0	3.00	90	16600 x (1±15%)

Notes:

- 1) Max voltage refers to the max voltage which the relay coil could endure for a short period of time.
- 2) For products with a rated voltage of ≥ 48V, measures should be taken to prevent the coil overvoltage in order to protect the coil and the application (eg. connect diodes in parallel).
- 3) Do not install RSLM001 types on either of the smallest sides or facing downward.

## Contact Characteristics

<b>Contact arrangement</b>	1 Form A (SPST - Normally Open) 1 Form C (SPDT - Changeover)	<b>Electrical endurance 001 (SPST type)</b>	6 x 10 <sup>4</sup> OPS (6A 250VAC / 30VDC Resistive load, AgNi, @ 85°C, 1s on 9s off) 3 x 10 <sup>4</sup> OPS (NO, 6A 250VAC / 30VDC, Resistive load; AgNi, @ 85°C, 1s on 9s off) 1 x 10 <sup>4</sup> OPS (NC, 6A 250VAC/30VDC, Resistive load, AgNi, @ 85°C, 1s on 9s off)
<b>Contact resistance</b>	100mΩ max. (@ 1A 6VDC) Gold plated: 30mΩ max. (@ 1A 6VDC)	<b>100 (SPDT type)</b>	
<b>Contact material</b>	AgNi	<b>Coil power</b>	
<b>Contact rating (Resistive Load)</b>	6A 250VAC / 30VDC	24VDC 48VDC, 60VDC	
<b>Max. switching voltage</b>	400VAC / 125VDC		
<b>Max. switching current</b>	6A		
<b>Max. switching power</b>	1500VA / 180W		
<b>Mechanical endurance</b>	1 x 10 <sup>7</sup> OPS		

## General Data

<b>Insulation resistance</b>	1000MΩ (@500VDC)	<b>Vibration resistance</b>	10Hz to 55Hz 1mm DA
<b>Dielectric strength</b>		<b>Humidity</b>	5% to 85% RH
Between coil & contacts	4000VAC 1 min	<b>Ambient temperature</b>	-40°C to 85°C
Between open contacts	1000VAC 1 min	<b>Terminal connections</b>	PCB
<b>Operate time</b>	8ms max. (at nominal voltage)	<b>Unit weight</b>	Approx. 5g
<b>Release time</b>	4ms max. (at nominal voltage)	<b>Construction</b>	Plastic sealed, flux proofed
<b>Shock resistance</b>			
Functional	49m/s <sup>2</sup>		
Destructive	980m/s <sup>2</sup>		

Notes:

- 1) The data shown above is standard
- 2) Please find coil temperature curve in the characteristic curves below
- 3) UL insulation system: Class A

## Dimensions

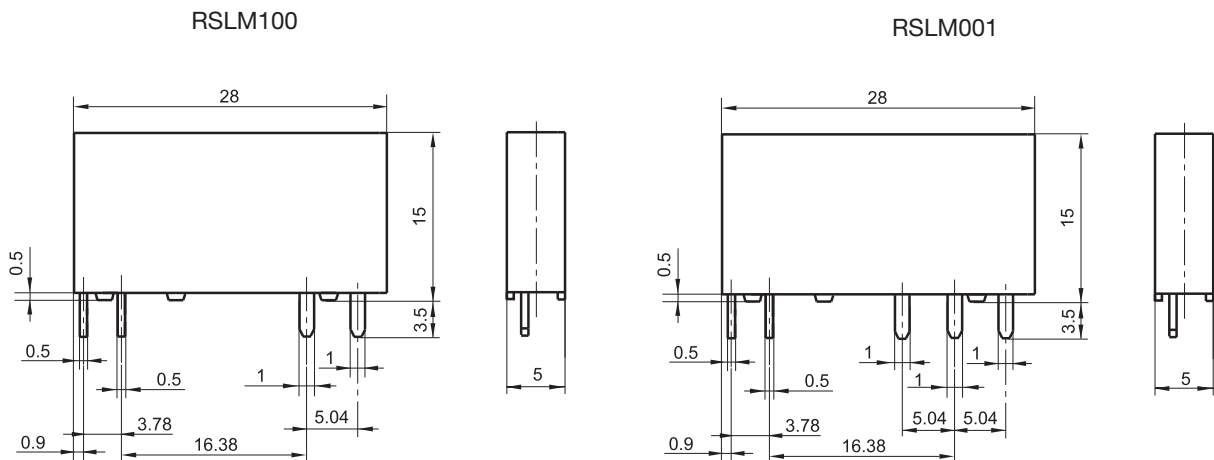

## Dimensions

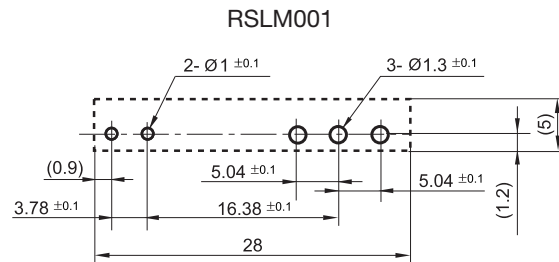
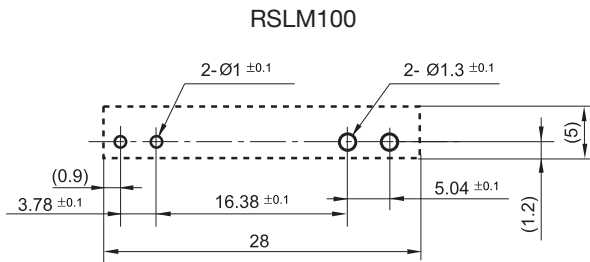

## Wiring Diagram

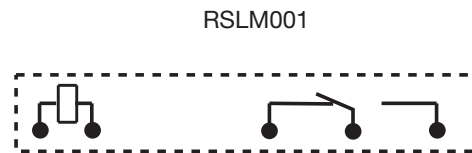
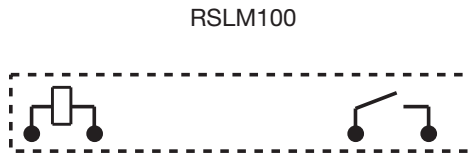

**Notes:**

Where no tolerance is shown in the dimensional diagram please consider the following tolerances:

- Outline dimension  $\leq 1\text{mm}$ , tolerance should be  $\pm 0.2\text{mm}$ ;
- Outline dimension  $> 1\text{mm}$  and  $\leq 5\text{mm}$ , tolerance should be  $\pm 0.3\text{mm}$ ,
- Outline dimension  $> 5\text{mm}$ , tolerance should be  $\pm 0.4\text{mm}$

## Characteristic Curves

**MAXIMUM SWITCHING POWER**

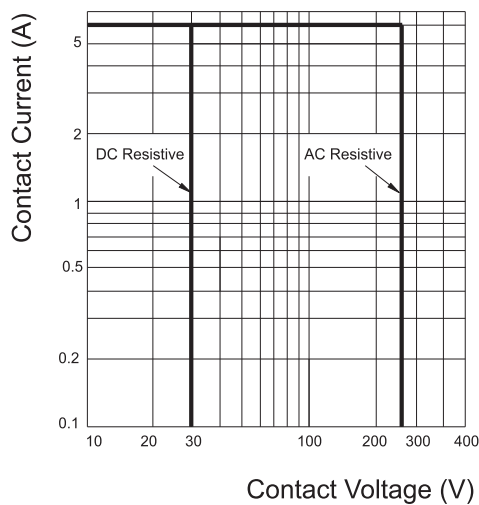

**ENDURANCE CURVE**

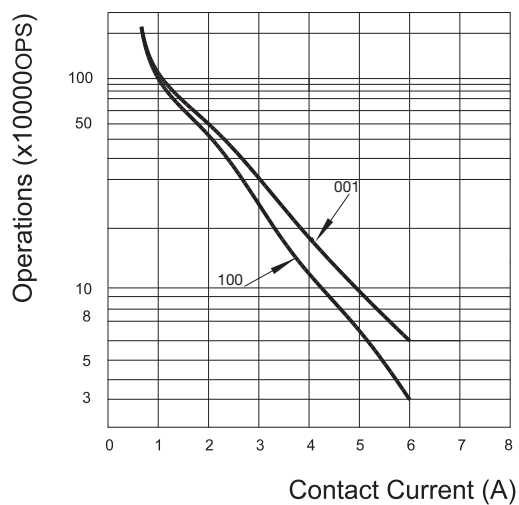

**Test conditions:**

NO, AgNi, Resistive load, 250VAC,  
 Flux proofed, Room temp., 1s on 9s off.

## Life Curves

### COIL TEMPERATURE RISE

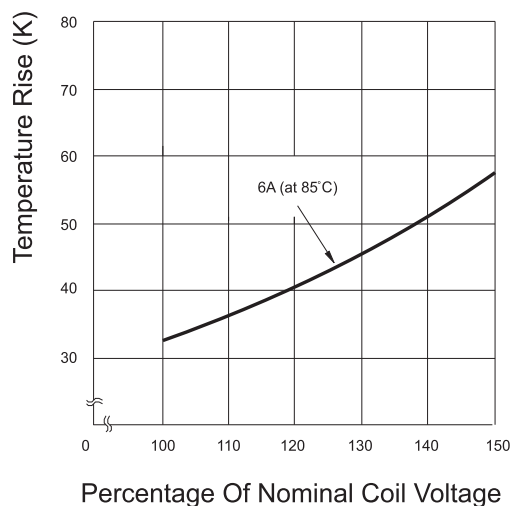

**Test conditions:**  
 6A 85°C  
 (Typical curve of 24VDC standard type)

## Socket Selection

Relay part number	Socket part number	Socket description
RSLM100012	ZRLS12GA / ZRLS12NA	DIN Rail socket for slim relays 12/24VAC-DC spring DIN Rail socket for slim relays 12/24VAC-DC screw
RSLM001012		
RSLM100024		
RSLM001024		
RSLM100048	ZRLS13GA / ZRLS13NA	DIN Rail socket for slim relays 48/60VAC / DC spring DIN Rail socket for slim relays 48/60VAC / DC screw
RSLM001048		
RSLM100060		
RSLM001060		
RSLM100060 RSLM001060	ZRLS14GA ZRLS14NA ZRLS15GA ZRLS15NA	DIN Rail socket for slim relays 110/125VAC / DC spring DIN Rail socket for slim relays 110/125VAC / DC screw DIN Rail socket for slim relays 220/240VAC / DC spring DIN Rail socket for slim relays 220/240VAC / DC screw

## Sockets for RSLM Relays

### ZRLS1 NA

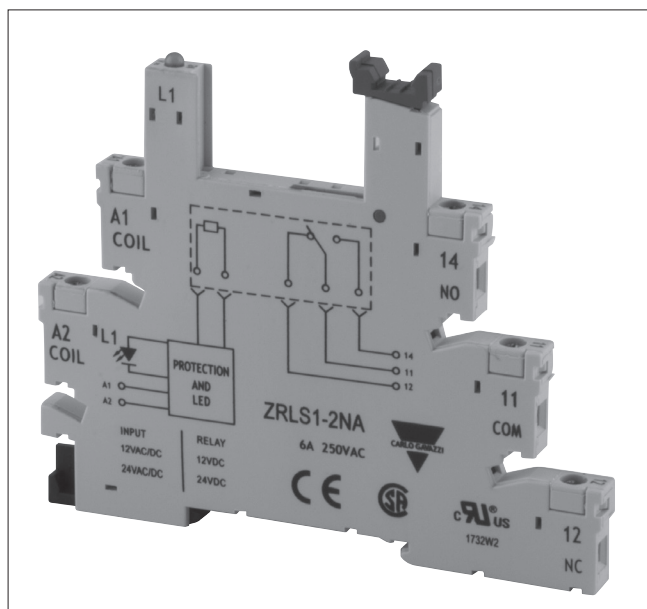

### mm/inches DIMENSIONS

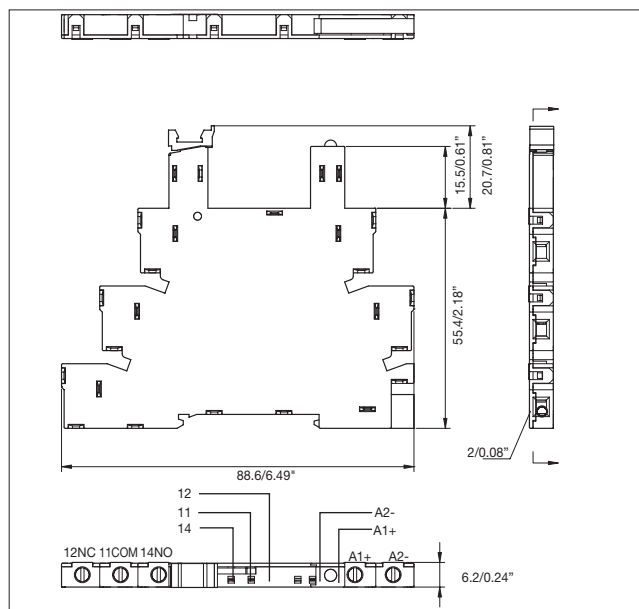

### General Data

Rated voltage	250VAC
Rated current	6A
Insulation voltage	>3kV
Protection degree	IP 20 B
Socket material	PA66+GF (V0)
Socket colour	RAL 7035 / Pantone 1C
Contacts material	CuSN 6.5-0.1
Contacts surface	Tin-plated
Terminal type	Screw cage
Operating temperature	-40° to +70°C (-40 to 158°F)
Max wire section	
Flex / Compact wire	2 x 2.5mm (14AWG)
Cable End	2 x 1.5mm (16AWG)

### Input data and Ordering code

<b>ZRLS1-2NA</b>	Input	6 to 24VAC/VDC
	Coil rate*	6 to 24VDC
<b>ZRLS1-3NA</b>	Input	48 to 60VAC/VDC
	Coil rate*	48 to 60VDC
<b>ZRLS1-4NA</b>	Input	110 to 125VAC/VDC
	Coil rate*	60VDC
<b>ZRLS1-5NA</b>	Input	220 to 240VAC/VDC
	Coil rate*	60VDC

\* The coil rate value is the socket output voltage. The relay to be fitted should have the same coil voltage.

### Output Data

Max voltage	300VAC max
Max current	6A

### Approvals



Box content: 20 sockets  
Box size: 130 x 85 x 95 mm  
5.1 x 3.3 x 3.7 inches  
Weight: 600g  
Weight: 21.16oz

### Optional Accessories (to be ordered separately if required)

Labels	ZRLS-LAB
Separator	ZRLS-DIV
Bridging bar	ZRLS-BB

## Sockets for RSLM Relays

### ZRLS1 GA

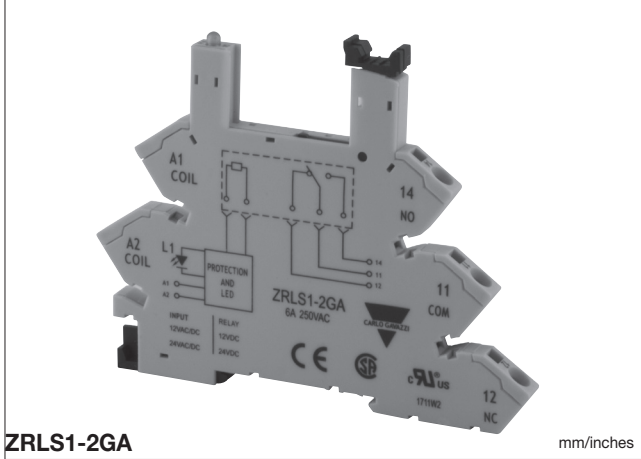

### mm/inches DIMENSIONS

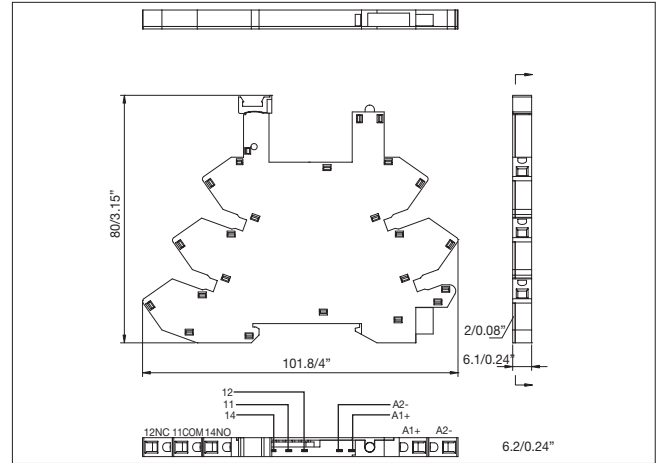

## General Data

Rated voltage	250VAC
Rated current	6A
Insulation voltage	>3kV
Protection degree	IP 20 B
Socket material	PA66+GF (V0)
Socket colour	RAL 7035 / Pantone 1C
Contacts material	CuSN 6.5-0.1
Contacts surface	Tin-plated
Terminal type	Spring loaded terminal
Operating temperature	-40° to +70°C (-40 to 158°F)
Max wire section	
Flex / Compact wire	2 x 2.5mm <sup>2</sup> (14AWG)
Cable End	2 x 1.5mm <sup>2</sup> (16AWG)

## Input data and Ordering code

<b>ZRLS1-2GA</b>	Input	6 to 24VAC/VDC
	Coil rate*	6 to 24VDC
<b>ZRLS1-3GA</b>	Input	48 to 60VAC/VDC
	Coil rate*	48 to 60VAC/VDC
<b>ZRLS1-4GA</b>	Input	110 to 125VAC/VDC
	Coil rate*	60VDC
<b>ZRLS1-5GA</b>	Input	220 to 240VAC/VDC
	Coil rate*	60VDC

\* The coil rate value is the socket output voltage. The relay to be fitted should have the same coil voltage.

## Output Data

Max voltage	300VAC max
Max current	6A

## Approvals



Box content:	20 sockets
Box size:	130 x 85 x 95 mm 5.1 x 3.3 x 3.7 inches
Weight:	600g
Weight:	21.16oz

## Optional Accessories (to be ordered separately if required)

Labels	ZRLS-LAB
Separator	ZRLS-DIV
Bridging bar	ZRLS-BB