

Important Notice

Restrictions in Use

The ZSC31010+15 SSC Mass Calibration System (MCS) hardware and software are designed for ZSC31010 or ZSC31015 evaluation, laboratory setup and module development only. The ZSC31010+15 SSC Mass Calibration System hardware and software must not be used for module production or production test setups.

Disclaimer

IDT shall not be liable for any damages arising out of defects resulting from

- (i) delivered hard- and software
- (ii) non-observance of instructions contained in this manual and in any other documentation provided to user, or
- (iii) misuse, abuse, use under abnormal conditions or alteration by anyone other than IDT.

To the extent permitted by law, IDT hereby expressly disclaims and user expressly waives any and all warranties, whether express, implied or statutory, including, without limitation, implied warranties of merchantability and of fitness for a particular purpose, statutory warranty of non-infringement and any other warranty that may arise by reason of usage of trade, custom or course of dealing.

Contents

1	Contents of the SSC Mass Calibration System (MCS)	3
2	Setting up the ZSC31010+15 Mass Calibration System (MCS)	4
2.1.	Main Board Hardware – Brief Description	4
2.2.	Preparing the MCS	6
2.3.	Installing the SSC Evaluation Software	7
2.4.	Connections to ZSC31010/ZSC31015 Sensor Modules	9
2.5.	ZSC31010/ZSC31015 Mass Calibration Reference Board	9
3	ZSC31010 or ZSC31015 Calibration with the SSC Mass Calibration Board and SSC Evaluation Software ...	11
3.1.	Software Overview	11
3.2.	SSC Evaluation Software Files	11
3.3.	Calibration Sequence	11
3.3.1.	Step 1 – Assigning a Unique Identification (ASIC ID Section)	12
3.3.2.	Step 2 – Data Collection	14
3.3.3.	Step 3 – Calculate & Write Coefficients	15
3.4.	Supporting Multi-Unit EEPROM Writing	17
3.5.	Dry Run Calibration: 2-Point Calibration with the MCRs	17

4	SSC Evaluation Software with the IDT SSC Terminal	19
4.1.	Protocol.....	19
4.2.	IDT SCC Terminal	19
5	Related Documents.....	21
6	Definitions of Acronyms.....	22
7	Document Revision History.....	22

List of Figures

Figure 1.1	ZSC31010+15 SSC Mass Calibration System MCS 1	3
Figure 2.1	Mass Calibration Board (MCB)	4
Figure 2.2	Pin Assignments for DUT Connectors on the MCB.....	5
Figure 2.3	Hardware Type Selection	7
Figure 2.4	Product and COM Port Selection.....	8
Figure 2.5	Main Dialog Window of the SSC Evaluation Software (ZSC31010 Coefficients Shown).....	9
Figure 2.6	ZSC31010+15 MCR	10
Figure 3.1	“ASIC ID” in the Calibration Window (ZSC31010 Coefficients Shown).....	12
Figure 3.2	Configuration Setup for the DUT during Initialization (ZSC31010 Settings Shown)	13
Figure 3.3	2-Point Calibration Example (ZSC31010 Coefficients Shown)	15
Figure 3.4	Verification of the DUTs’ Calibration.....	16
Figure 3.5	Verifying Operation after Calibration	17
Figure 4.1	SSC Terminal Example	20

List of Tables

Table 2.1	Overview of Required Jumper/Connector Settings for MCB V2.1.....	5
Table 4.1	IDT SSC Terminal Command Format	19

1 Contents of the SSC Mass Calibration System (MCS)

The SSC Mass Calibration System (MCS) provides the hardware and software for communicating with and calibrating multiple ZSC31010/ZSC31015 sensor signal conditioning ICs (DUTs). It includes 4 SSC Mass Calibration Boards (SSC MCBs), allowing mass calibration of up to 96 DUTs. The system can operate with up to 8 SSC MCBs, allowing calibration of up to 192 DUTs. (Additional MCBs, Mass Calibration Reference Boards, and components can be purchased separately. See *ZSC31xxx_ZSSC3xxx_MCS_V.x_Feature_Sheet_rev_X.x.pdf*.)

The SSC Mass Calibration System includes the following:

- DVD—ZSC31010+15 SSC Evaluation software and documentation (MCS uses SSC Evaluation Kit software)
- SSC Communication Board (CB) with one USB cable (see *ZSC31xxx_ZSSC3xxx_CommunicationBoard_VX-x_DataSheet_Rev_X.x.pdf* and *ZSC3xxxCommandSyntax.xls* under *Manual Evaluation Kit* on the DVD.)*
- 4 Mass Calibration Boards (SSC MCB) for 4X24=96 DUTs (see *ZSC31xxx_ZSSC3xxx_MCS_V.x_Feature_Sheet_rev_X.x.pdf* in the *Mass Calibration System MCS1* folder on the DVD.)
- 100 flat cable connectors / 30m of 10-wire flat cable
- 4 ZSC31010 or ZSC31015 Mass Calibration Reference Boards (MCR) for testing (see section 2.5.)

Figure 1.1 ZSC31010+15 SSC Mass Calibration System MCS 1

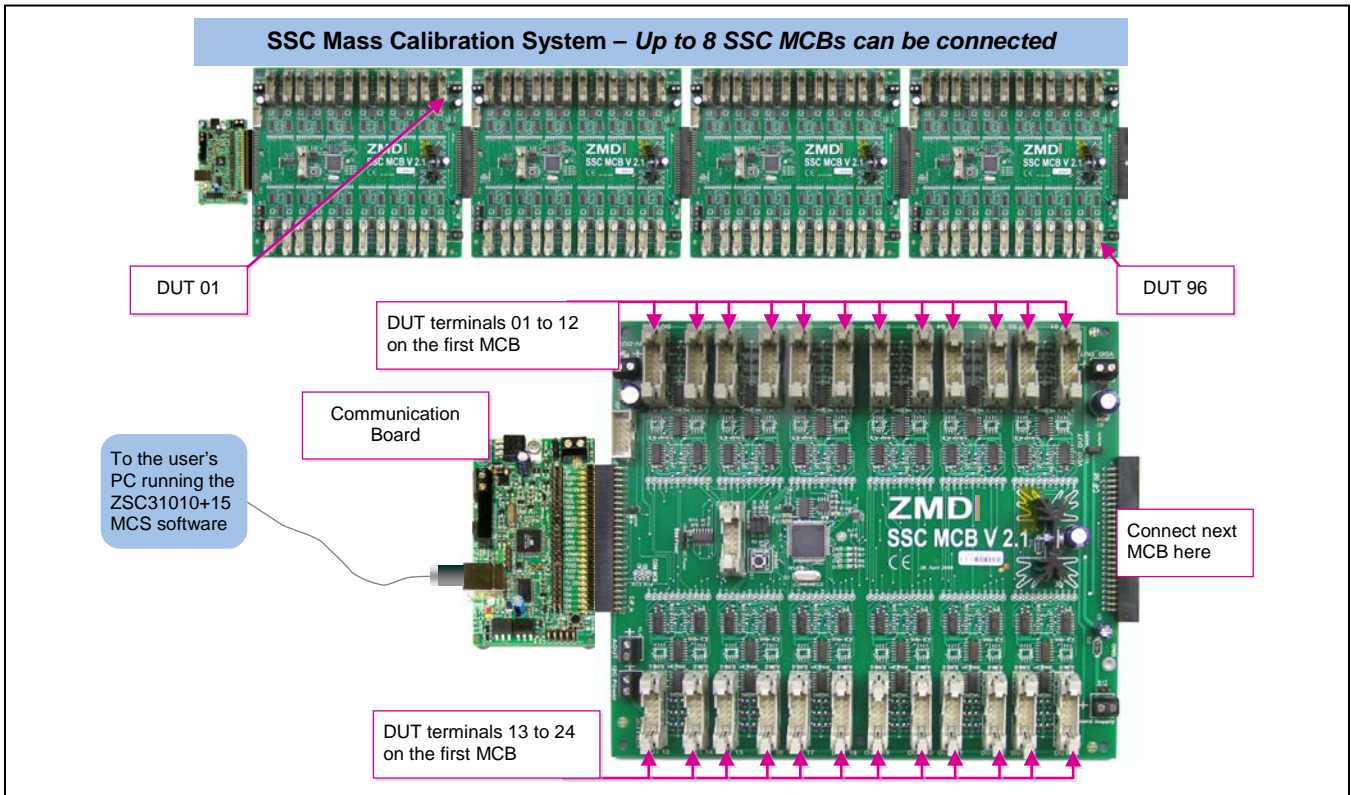

* The CB firmware must be updated to revision 2.19a or higher.

2 Setting up the ZSC31010+15 Mass Calibration System (MCS)

2.1. Main Board Hardware – Brief Description

Figure 2.1 Mass Calibration Board (MCB)

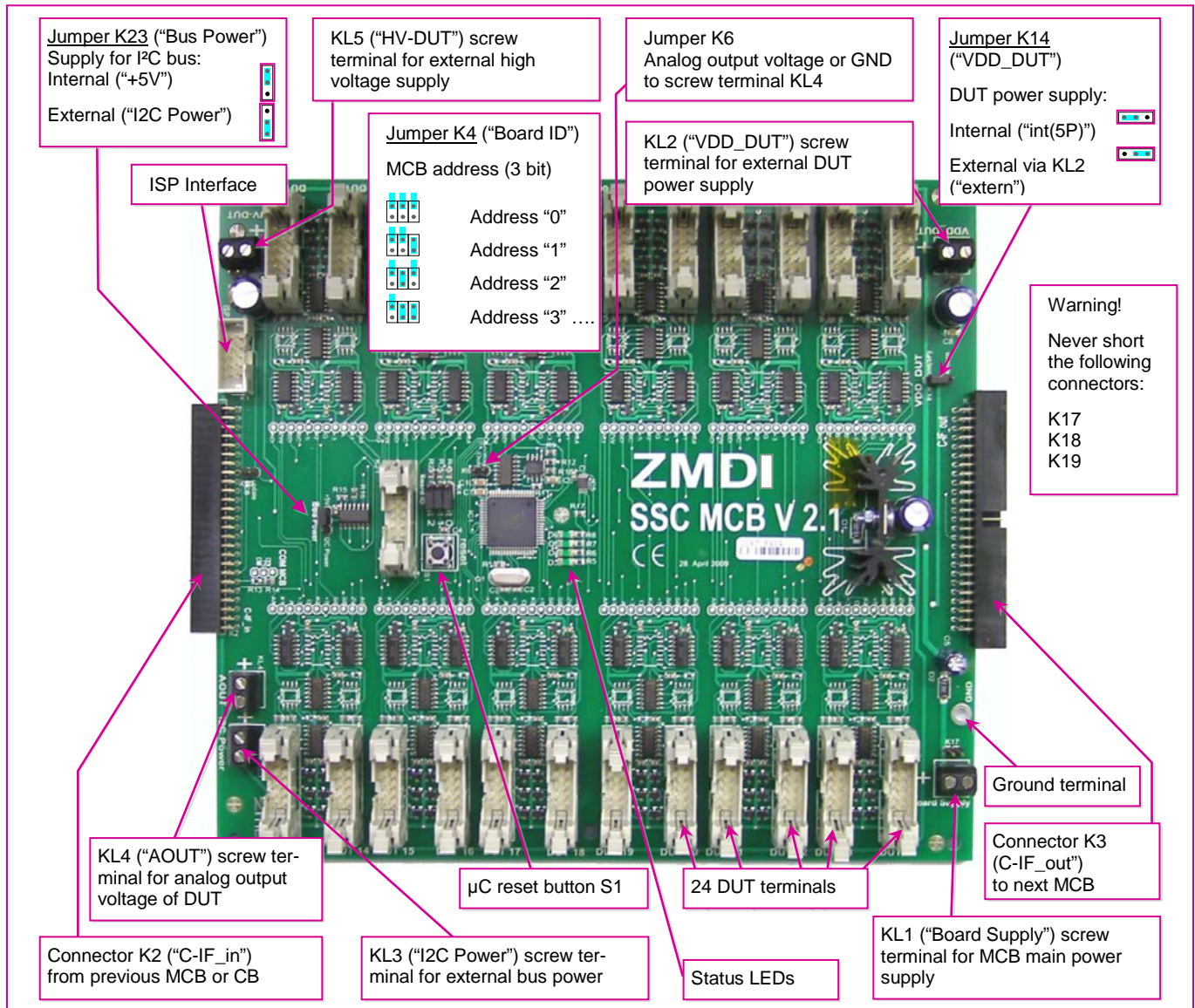

Each of the 24 DUT connectors on each MCB has the pin assignment shown in Figure 2.2. Note the orientation of the key.

Figure 2.2 Pin Assignments for DUT Connectors on the MCB

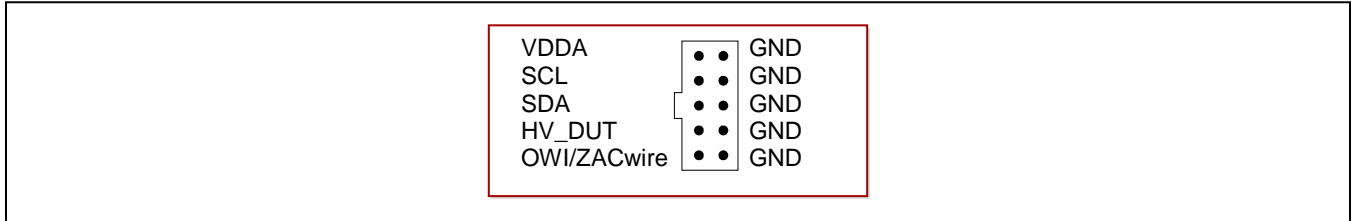

Each MCB is capable of communicating with and calibrating up to 24 ZSC31010/ZSC31015 DUT modules using the ZACwire™ protocol. When the ZSC31010/ZSC31015 is programmed for the Absolute Analog Voltage or Ratiometric Analog Voltage Output Mode, the voltage can be measured using the ADC (10-bit) on the CB (see *ZSC31xxx_ZSSC3xxx_CommunicationBoard_VX-x_DataSheet_Rev_X_x.pdf*). Customer modules without JFET regulation (voltage supply = 3V to 5V) can be directly connected to the DUT terminals.

Up to 8 MCBs with identical settings (except the address settings) can be connected in series and controlled by one CB. The address for each board must be assigned manually via jumper K4 starting with address 000 and numbered in ascending order. Each board must be connected separately to an external main power supply in the range of 8V to 16V DC. By multiplexing the power supply of each DUT, an individual configuration and calibration is possible.

Table 2.1 Overview of Required Jumper/Connector Settings for MCB V2.1

Jumper/Connector †	Required Setting or Connections	Comments
Jumper K4 (“Board ID”): Bits 0,1,2	All open = “000” 1st MCB=“000” 2 nd MCB=“001” 3 rd MCB=“010” 4 th MCB=“011” ...	Assign first MCB to address=“000.” Assign remaining MCBs in ascending order. See labels on board for bit assignments for jumpers.
Jumper K6	Open	Open selects analog voltage output measurement. A jumper on K6 shorts the output to ground.
Jumper K14 (“VDD_DUT”) & Connectors KL1 (“Board Supply”) & KL2 (“VDD_DUT”)	Short center pin to “Int(5P)” for internal DUT power. Short center pin to “extern” for external DUT power.	To power the DUTs with the internal MCB 5V supply, put the K14 jumper on “Int(5P)” and apply the MCB board power (8V to 16V DC) to “Board Supply” (KL1). To use a separate (lower) supply voltage for the DUTs, put the K14 jumper on “extern” and connect the DUT supply to “VDD_DUT” (KL2). Apply MCB board power (8V to 16V DC) to “Board Supply” (KL1). Note: Both KL2 and KL3 should be powered with the same supply voltage.

† Note that connectors K17, K18, and K19 can be used as alternative power connectors for the adjacent screw terminals. **Important:** Never attach jumper shunts to these connectors.

Jumper/ Connector †	Required Setting or Connections	Comments
Jumper K23 (“BUS Power”) & Connector KL3 (“I ² C Power”)	Short center pin to “+5V” for internal bus power.	Use this setting to power the bus with the internal MCB 5V supply.
	Short center pin to “I ² C Power” for external bus power.	Use this setting to use a separate (lower) supply voltage for the bus. Connect the bus supply to “I ² C Power” (KL3). Note: Both KL2 and KL3 should be powered with the same supply voltage.
C-IF_in (Connector K2)	Connect to CB or previous MCB.	For first MCB: connection to the Communication Board (CB). For remaining MCBs, connect to previous MCB.
C-IF_out (Connector K3)	Connect to next MCB.	Connect to next MCB.
Connectors DUT 01 ...	Connect to MCRs or user-provided modules.	Insert MCRs or user-provided modules # 01 through # 24 in DUT connectors # 01 through # 24 (also called port #...)

The MCBs are connected in series to the Communication Board (CB). The Communication Board interfaces to the host PC through a USB connection. This connection provides the serial communication. The PC sends commands and data via the USB (virtual COM port). The μ Controller on the board interprets these commands and relays them in the ZACwire™ format to one selected unit of the up to 192 DUT modules. The μ Controller also forwards any data bytes from the selected DUT module back to the PC via the USB connection.

Reset Button

Hit the RESET button on the CB to RESET the μ Processor on the MCBs.

2.2. Preparing the MCS

Important: Do not connect the USB cable or turn on the MCB power supplies until directed in the steps below.

- Set up each MCB with the proper jumper settings given in Table 2.1 and connect all the MCBs together in series in ascending order. Remember that all MCBs must have identical settings except for the address setting.
- Connect the first MCB to the CB as shown in Figure 1.1.
- Insert the MCRs or user-provided sensor modules to be calibrated in the DUT connectors 01 to 24 (see section 2.5 or 2.4) on each board.
- Connect the power supplies to all MCBs, but do not turn them on yet.
- Connect the CB to the PC using a USB cable. Verify that the green PWR LED is lit on the CB.
- Turn on the power supplies for the MCBs and if applicable, the DUTs’ separate power supplies.

2.3. Installing the SSC Evaluation Software

The ZSC31010+15 MCS uses the same SSC Evaluation software as the ZSC31010+15 SSC Evaluation Kit (used for single-unit evaluation and calibration), which is provided on the MCS DVD, for evaluating and calibrating the ZSC31010/ZSC31015 DUT modules.

Note: Before using the SSC Evaluation software, install the USB drivers provided on the MCS DVD as described in *SSC_AN_CommunicationBoard_Driver_Installation_Rev_X_x.pdf*. These drivers set up the user's PC's USB port as a virtual COM port.

To install the SSC Evaluation software on the user's PC hard drive, locate the *ZSC31010_31015 Installer.msi* file in the root directory of the DVD, and double click on it. The software automatically completes the installation and creates a program shortcut on the PC desktop. The installation folder is (*C:\Program Files\ZMDI\ZSC31010_31015*). When the software is activated for the first time, the kit type ("HW type") and product type (ZSC31010 or ZSC31015) must be selected and the COM port must be entered as described below.

After setting up the hardware as described in sections 2.1 and 2.2, open the SSC Evaluation software. On the "Setup" menu, select "HW Type" and then "SSC MCB" on the pull-down menus as shown in Figure 2.3.

Figure 2.3 Hardware Type Selection

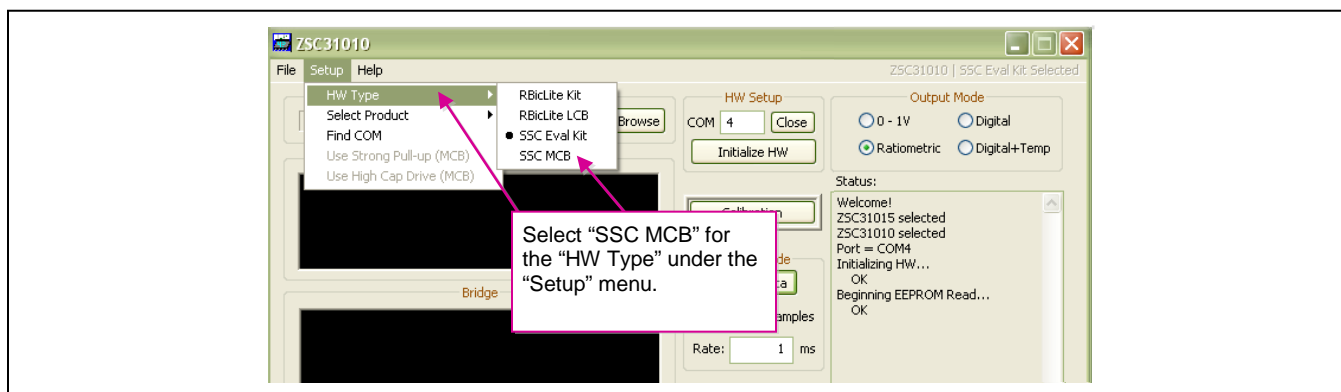

Note: If communication fails and there is a resistor in series at the SIG™ pin of the ZSC31010/ZSC31015 (e.g. for short protection), select the "Use Strong Pull-up (MCB)" setting on the "Setup" menu to improve the ZACwire™ pulse rise time. If using capacitances at the SIG™ pin, select the "Use High Cap Drive (MCB)" setting to improve the ZACwire™ pulse rise time. Refer to the data sheet for more details.

Then click on "Select Product" under the "Setup" menu and select either ZSC31010 or ZSC31015 as shown in Figure 2.4. The title bar of the screen will change to reflect the ZSC31010 or ZSC31015 selection.

Next, enter the correct virtual COM port setting to use for the PC ↔ SSC MCB communication via USB and click "Open." If the correct setting is unknown, click the "Find COM" button and accept the port found or continue searching until communication is established as indicated in the "Status" window.

Figure 2.4 Product and COM Port Selection

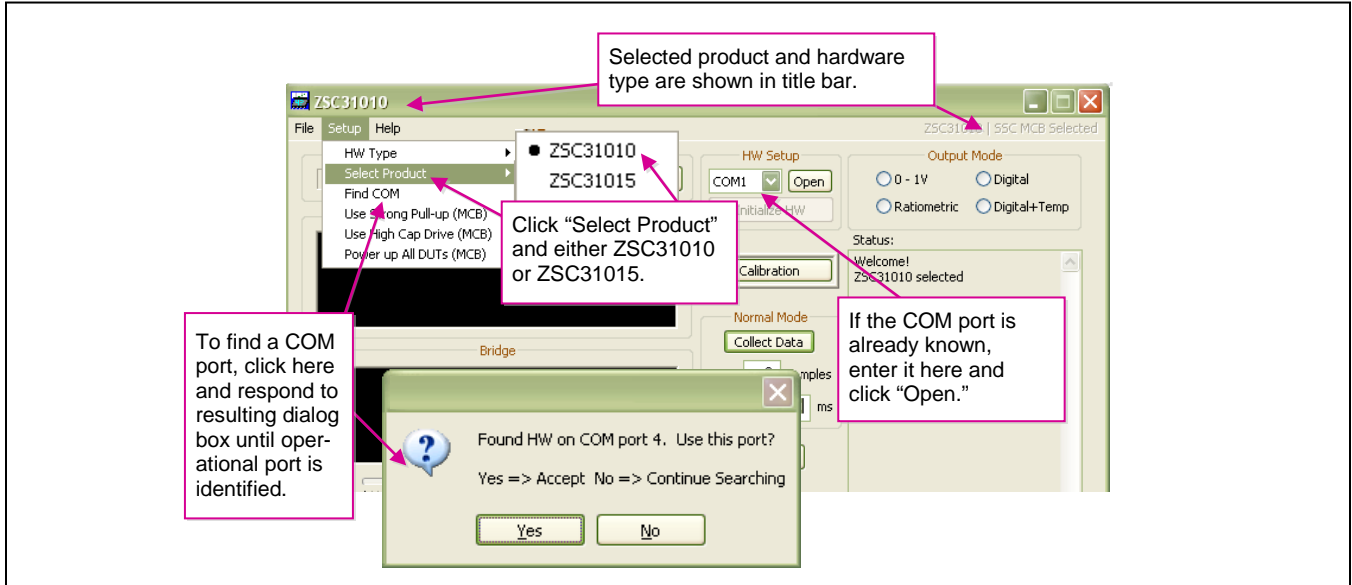

Click on "Initialize HW" to set up the SSC hardware for operation (see Figure 2.5).

If the Initialization was successful, the status window on the right side of the screen will say "Initializing HW... OK." If communication fails, an error message detailing the reason for failure will be displayed. For a full list of all communication-related error messages, see the "Error-Code" tab in *ZSC3xxxxCommandSyntax.xls*.

Figure 2.5 Main Dialog Window of the SSC Evaluation Software (ZSC31010 Coefficients Shown)

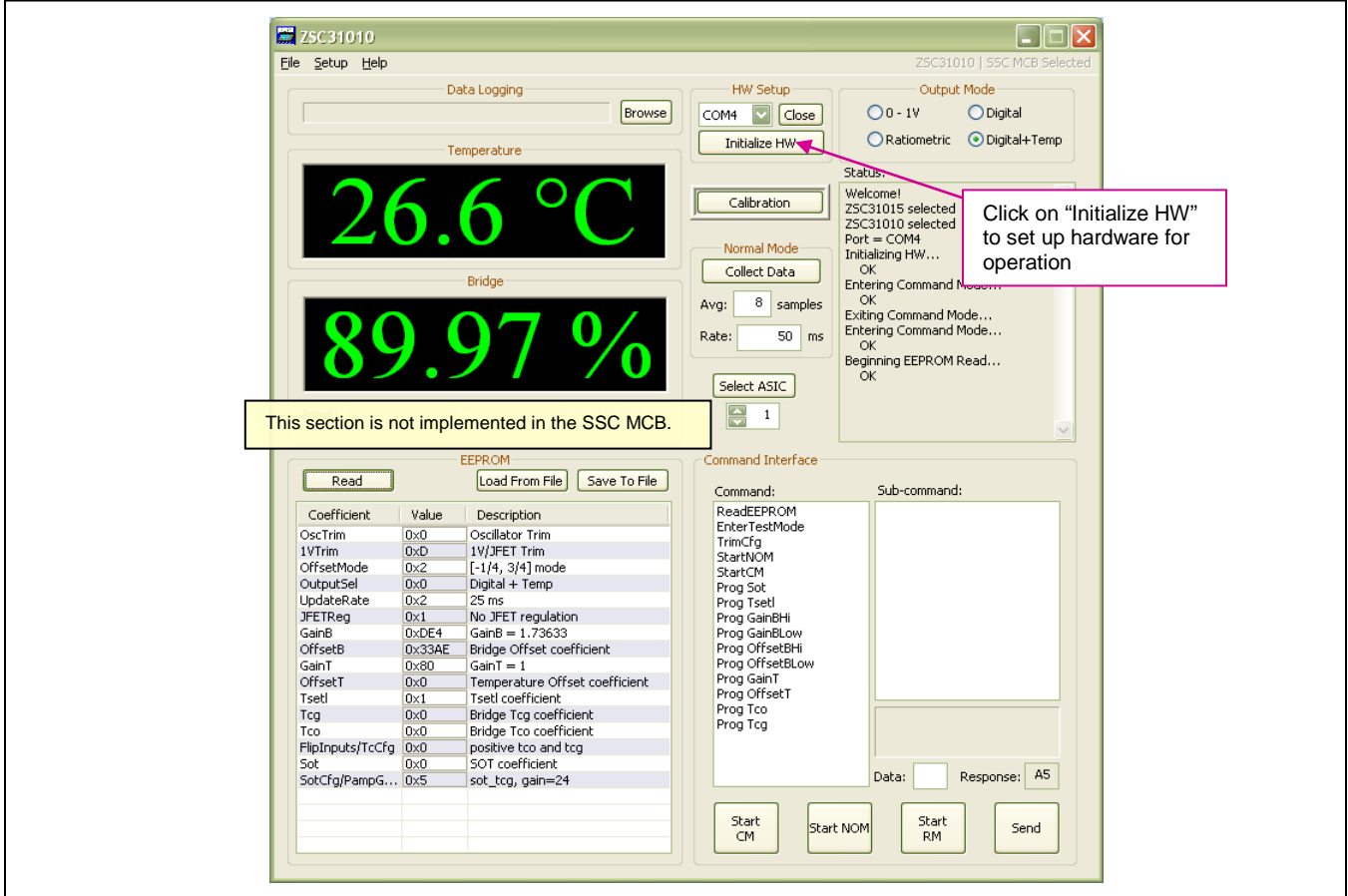

2.4. Connections to ZSC31010/ZSC31015 Sensor Modules

The MCB provides direct connections to the sensor modules containing the ZSC31010/ZSC31015 DUTs via flat cable connectors if the module supply voltage is 5.5V and less. For supply voltages less than 5V, a separate voltage supply is needed (screw terminal KL2 on MCB; see Table 2.1). Higher external supply voltages needed for modules with JFET regulation require a separate high voltage adaptation board for each module (see *ZSC31xxx_ZSSC3xxx_MCS_V.x_Feature_Sheet_rev_X_x.pdf*).

The labels on the board near the connectors indicate the DUT numbering.

2.5. ZSC31010/ZSC31015 Mass Calibration Reference Board

The MCB includes four ZSC31010 or ZSC31015 MCRs. See Figure 2.6 for the schematic and layout of the MCR. The MCR simulates a typical application circuit (without JFET regulation), which allows checking the ZACwire™ communication and simulating a 2-point calibration with the K3 jumper on the MCR shorted for the first calibration point and then open for the second point.

Refer to section 3.5 for procedures for a “dry-run” calibration using the MCRs after reviewing the calibration example given in section 3.3. Figure 3.2 shows the initialization settings to use with the MCR during the “dry-run” calibration.

Figure 2.6 ZSC31010+15 MCR

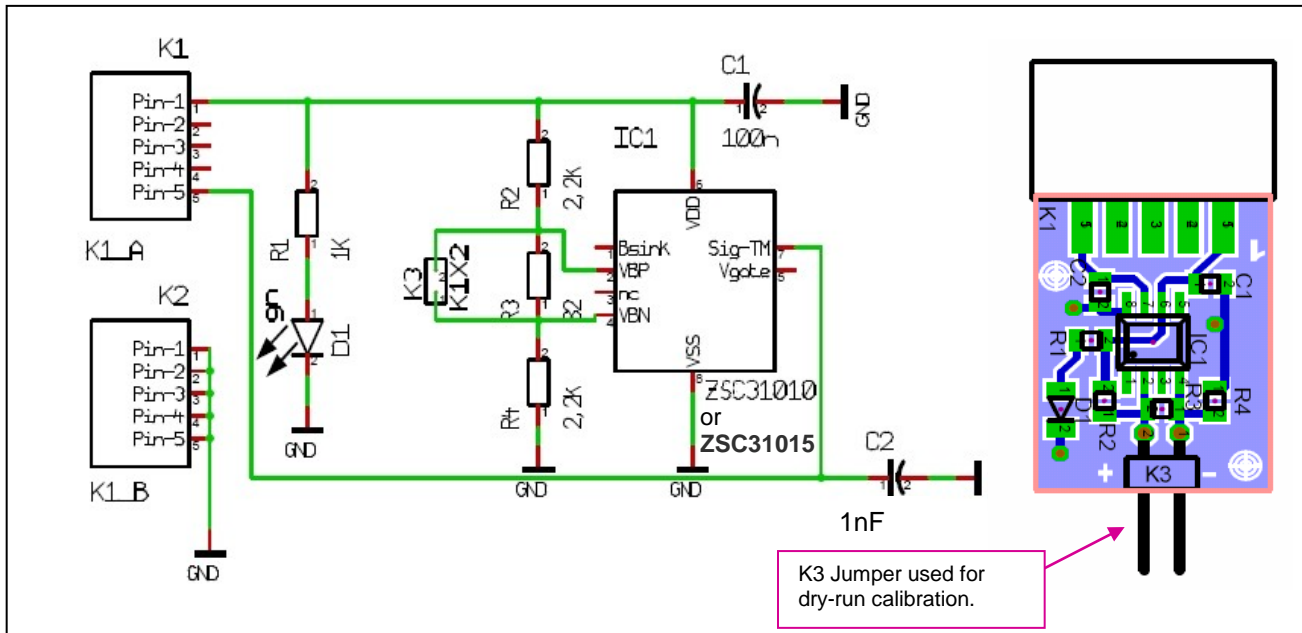

3 ZSC31010 or ZCS31015 Calibration with the SSC Mass Calibration Board and SSC Evaluation Software

3.1. Software Overview

IDT's SSC Evaluation software provided with the SSC MCS is intended for demonstration purposes and calibration of a limited number of units. Although the software is not intended for production volume calibration/testing, IDT can provide users with algorithms and assistance in developing their full production calibration software. Reading the data sheet for an understanding of the operation and calibration of the ZSC31010/ ZSC31015 before using the SSC Evaluation software is strongly recommended.

The SSC Evaluation software handles collecting data, storing it in an internal database, and using it to calculate and write calibration coefficients to EEPROM. During this process, it generates a unique identification number for the ASIC, which is programmed in EEPROM and can be used as an index in the database. This database will contain all the raw values of bridge readings and temperature readings for that part, as well as the known pressure and temperature to which the sensor bridge was exposed.

3.2. SSC Evaluation Software Files

Four types of text files support the software user. These files are saved in the *My Documents* folder under *ZMD\ZSC31010* or *ZMD\ZSC31015* depending on the "Select Product" setting described in section 2.3.

- When the software is activated, a *CommLog.txt* file is saved. This file is a log of the communication to the IC during the software session and can be saved after closing the software by renaming the file. Otherwise, it would be overwritten the next time the software is opened.
- In Command Mode (CM), the user can save/load the EEPROM contents from a user-selected *.eep file to the EEPROM.
- In Normal Operation Mode (NOM), the user can log bridge and temperature readings to a user-selected file.
- The calibration is documented in the *CalibrationLog_DDMMYYYY.txt* file.

3.3. Calibration Sequence

Although the ZSC31010/ZSC31015 can function with many different types of resistive bridges, assume it is connected to a pressure bridge for the following calibration example. In this case, calibration essentially involves collecting raw bridge and temperature data from the ZSC31010/ZSC31015 DUT for different known pressures and temperatures. This raw data can then be processed by the calibration master (the PC), and the calculated coefficients can then be written to the EEPROM of the DUT.

Overview of the Three Main Steps to Calibration with the SSC MCS

- Assigning a unique identification to the DUT and selecting the configuration settings.
- Collecting data. Data collection involves getting raw data from the bridge at different known pressures and temperatures. This data is then stored on the calibration PC using the unique identification of the DUT as the index into the internal database.
- Calculating and writing coefficients to EEPROM. After enough data points have been collected to calculate all the desired coefficients, the coefficients can be calculated by the SSC Evaluation software and written to the EEPROM of the DUT.

3.3.1. Step 1 – Assigning a Unique Identification (ASIC ID Section)

Click the “Calibration” button on the main dialog window (Figure 2.5). On the resulting calibration window (see Figure 3.1), enter the number of sensor modules (1-192) connected to the Mass Calibration Boards in the “# ASICs” field in the lower left corner, which will be activated when the Mass Calibration Board is being used.

Figure 3.1 “ASIC ID” in the Calibration Window (ZSC31010 Coefficients Shown)

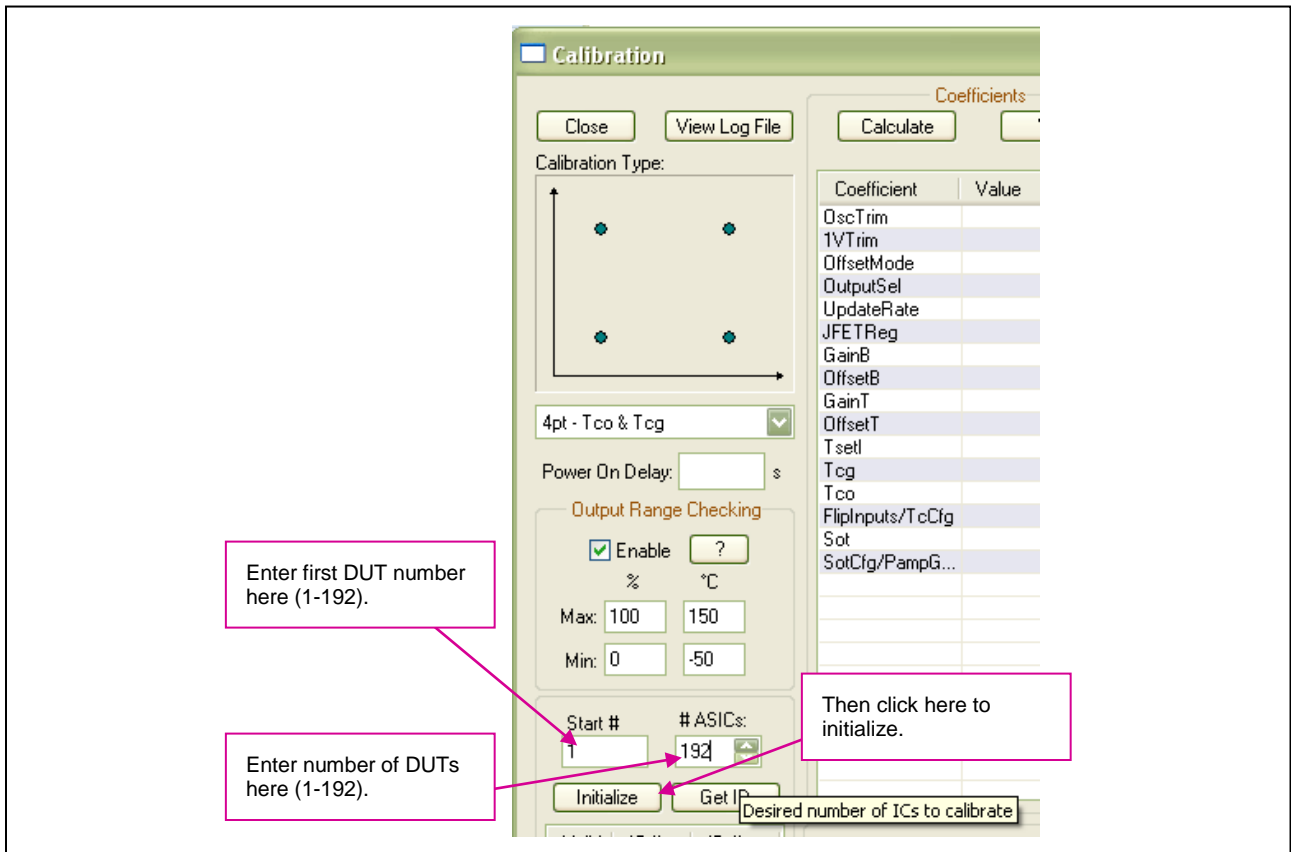

Click on “Initialize” in the “ASIC ID” section in the bottom left corner of the calibration screen. A dialog box results (see Figure 3.2). Complete the fields for Output Select, Update Rate, JFET Regulation, Pre-Amp Gain, A2D Offset Modes, and Flip Bridge Inputs to select the DUT configuration, and then click OK. Settings that are not available for the selected product are disabled. When the MCB is being used, these initialization commands are applied to all sensor modules currently connected.

Note: It is assumed that the sensors being calibrated are well understood and that the user has previously calibrated units using the single-unit ZSC31010+15 SSC Evaluation Kit or RBic Development Kit and has determined which A2D offset mode(s) are best suited for this sensor. During raw data collection, bridge and temperature readings are collected from the modules for all enabled A2D modes. Enabling more A2D offset modes than necessary increases calibration time.

Figure 3.2 Configuration Setup for the DUT during Initialization (ZSC31010 Settings Shown)

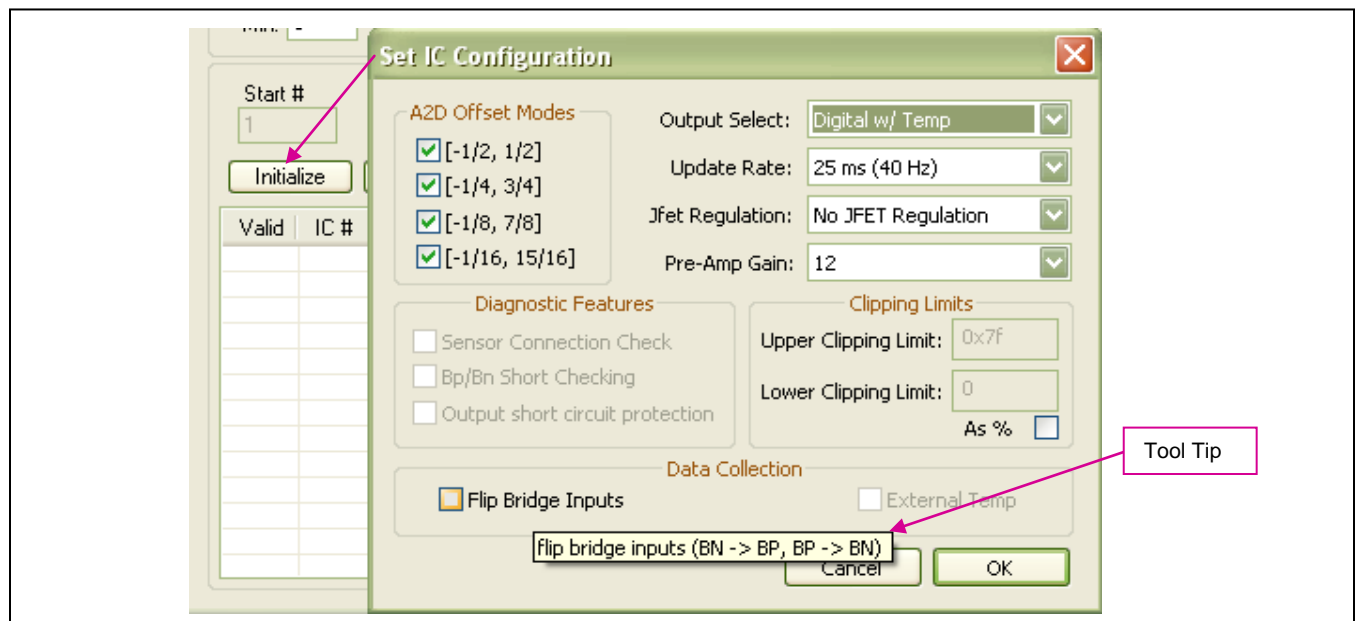

A pre-amp gain of 24 is the default and sufficient for most bridges. Bridges that produce a large signal (>40mV/V differential (max-min)) must use the lower gain setting of 12 for the ZSC31010 or 6 for the ZSC31015. For bridges that have a small output signal (<2mV/V), using a higher gain setting of 48 will increase output resolution (for the ZSC31015, a gain of 96 is also possible). For more details, see IDT’s document *ZSC31010+15 SSC Modular Evaluation Kit*, and refer to the “Adjustment of the Analog Pre-Amp Gain and the Analog ADC Offset Modes” section.

EEPROM registers Tco, Tcg, and TSETL for the ZSC31010 or customer ID0, ID1, and ID2 for ZSC31015 are each 8-bit EEPROM registers that together can form a 24-bit register for the temporary storage of a unique identifier for each DUT. Clicking the “Initialize” button and then OK causes the PC program to generate this unique 24-bit identifier and temporarily program it into the registers {Tco, Tcg, TSETL} for the ZSC31010 or {ID0, ID1, ID2} for the ZSC31015 for each DUT sequentially by issuing commands to the Mass Calibration Board. The program also creates an internal database entry indexed by this unique identifier in *caldata.txt*. When data read-

ings for a calibration data point have been collected for all the modules during the following calibration steps, the points are written to the internal database using this index.

The program also writes temporary values to several EEPROM registers for the raw data collection:

- Gain_B is programmed to unity (8008_H, 9000_H)
- Gain_T is programmed to unity (C080_H)
- Offset_T is programmed to zero (D000_H)
- Update_Rate is set to its 2nd fastest rate (3041_H)
- The ZSC31010/ZSC31015 is programmed to Digital Mode with Temperature (0x3030)

3.3.2. Step 2 – Data Collection

Calibration Type Section with the Small Bridge-Temperature Graph

The next step is selecting the type of calibration. The number of unique points (for this example, pressure and temperature points) at which calibration must be performed depends on the user's requirements. The minimum is a 2-point calibration, and the maximum is a 5-point calibration. The software allows using additional measurement points for calibration.

Under "Calibration Type" in the upper left section of the calibration screen (see Figure 3.1), there is a smaller graph (X-axis = Temperature, Y-axis = Bridge (pressure for this example)). This graph outlines the recommended spread of points (bridge and temperature) to be used for calibration.

→ **Choose the desired calibration type** from the drop-down list box below the smaller graph.

Calibration Control Section

Place the sensor modules to be calibrated in a controlled environment (e.g., pressure/temperature chamber), and stabilize the environment at the first desired calibration point. In the "Calibration Control" section, enter the temperature of the chamber and the desired bridge read out (in %) of the ZSC31010/ZSC31015 at this pressure. See Figure 3.3.

→ **Click on "Add New Point."** The software sequentially collects and averages the raw data for the given set of conditions (bridge and temperature) for all the modules connected starting with the module number entered under "Start #." For the currently selected DUT, data is plotted on the large bridge vs. temperature graph—on the X-axis according to the raw temperature reading from the part and on the Y-axis according to the desired % value entered in the previous step. The given chamber conditions and averaged raw data are then recorded in the internal database indexed by the unique identifier (see section 3.3.1) currently stored in the DUT being calibrated.

The program automatically repeats this process for the number of DUT modules entered in the #ASICs field and displays a status window to indicate the progress of the mass calibration.

For further details on raw data collection and processing, refer to *ZSC31010_RBic_Lite_App_Notes_Calibration_DLL+EXE.pdf* or *ZSC31015_RBic_dLite_App_Notes_Calibration_DLL+EXE.pdf*.

→ **Change the pressure/temperature of the modules being calibrated and take as many more points as needed.**

Hints: For better calibration results, choose the temperature and read-out (%) values as close as possible to the desired working range.

If power to the sensor modules is interrupted between taking measurements for different temperature calibration points, click the “Get ID” button, which causes the software to read the unique identifier (see section 3.3.1) for all the modules so that when it is time to add new calibration points to the internal database, the software knows the DUT modules’ indexes in the database.

Figure 3.3 2-Point Calibration Example (ZSC31010 Coefficients Shown)

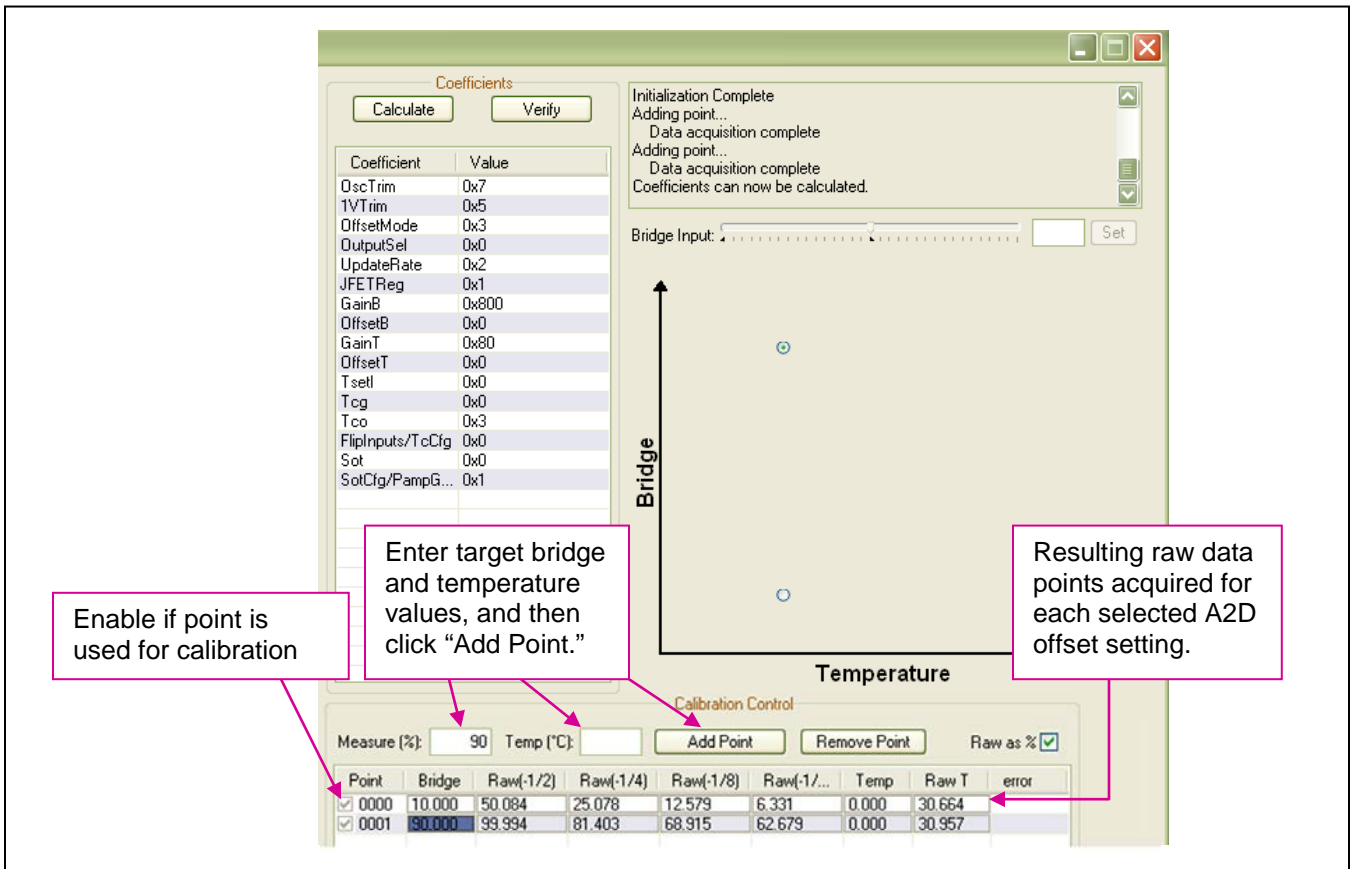

3.3.3. Step 3 – Calculate & Write Coefficients

After enough data points have been collected to calculate the calibration coefficients for each of the DUT modules, the “Calculate” button becomes active. Click this button. The software calculates all the coefficients, writes them to EEPROM for all connected modules, and frees up the indices for future use. The bridge/IC pairs are now calibrated. The software recalculates the desired output bridge values and displays the difference as an error for

each point in the “error” column in this table. Additional points not included in the calibration can be added for validation. The software will display an error message if the calibration does not complete successfully.

For a full list of calibration-related error codes, see *ZSC31010_RBic_Lite_App_Notes_Calibration_DLL+EXE_revX.X.pdf* or *ZSC31015_RBic_Lite_App_Notes_Calibration_DLL+EXE_revX.X.pdf*.

After calibration has been completed, the database entries for the sensor modules are removed from the database and their unique identifiers are recycled. IDT provides a DLL to aid in coefficient calculation. Details for the DLL can be found in *ZSC31010_RBic_Lite_Tech_Notes_Calibration_DLL+EXE.pdf* or *ZSC31015_RBic_dLite_Tech_Notes_Calibration_DLL+EXE.pdf*.

The calibrated DUTs can be verified point-wise for a range of DUTs by clicking on the “Verify” button on the calibration screen (see Figure 3.3), completing the “Start #” and “Num ICs” fields on the resulting “Verification” screen (see Figure 3.4), and clicking “Verify Point.” Click on “Write To File” to store the displayed verification results in a user-selected text file.

Figure 3.4 Verification of the DUTs’ Calibration

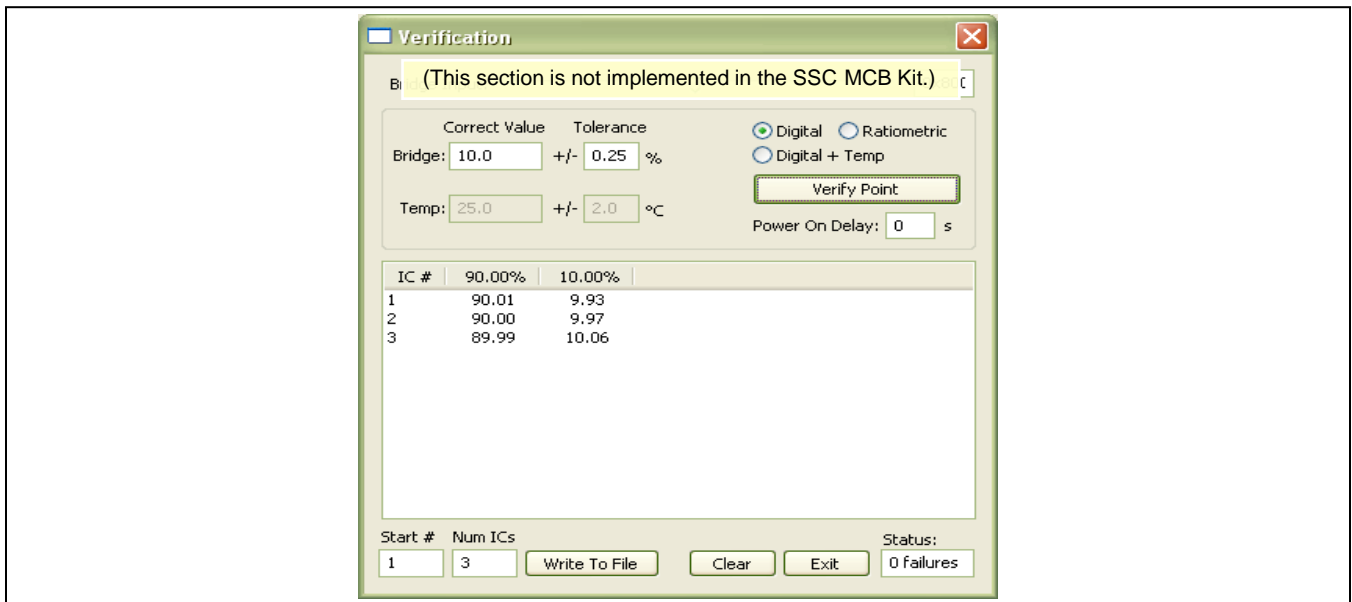

After closing the calibration window and returning to the main window, the calibration results can be viewed by entering the number of the DUT in the field below the “Select ASIC” button (see Figure 3.5) and clicking the button. Open and close the K3 jumper on the MCR (see Figure 2.6), and verify that the displayed measurements indicate a successful calibration.

Figure 3.5 Verifying Operation after Calibration

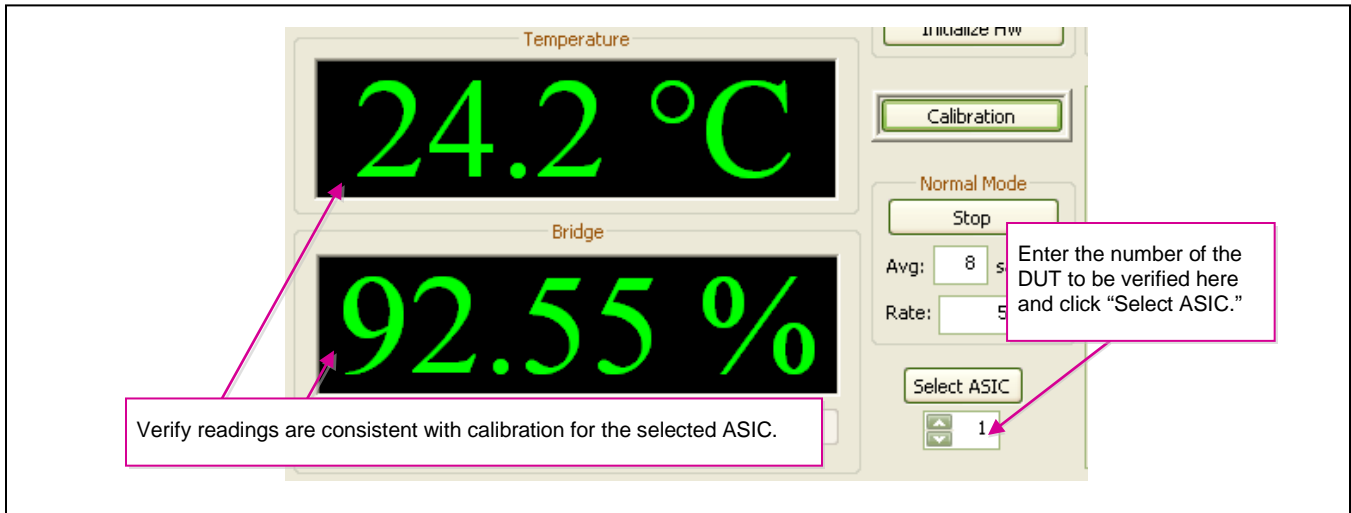

3.4. Supporting Multi-Unit EEPROM Writing

Each DUT has a specific trim setting programmed in the final test in IDT and should not be overwritten during calibration. During the initialization procedure, the software supports the multi-unit EEPROM programming of the application-specific settings in a loop for all DUTs (refer to Figure 3.2 for details.)

3.5. Dry Run Calibration: 2-Point Calibration with the MCRs

The following steps perform an example of a simple 2-point linear calibration using the Mass Calibration Reference Boards (MCR):

- Prepare the MCS by connecting the CB, MCB, MCR, and USB cable as described in section 2.2. Short the K3 jumper on the MCRs (see Figure 2.6). Verify that the green PWR LED is lit on the CB.
- Activate the SSC Evaluation software.
- Select "SSC MCB" under "Board Type." Select the actual product (ZSC31010 or ZSC31015) under "Select Product." Select the proper COM port. Click on "Initialize Hardware."
- Click on "START CM." If the setup is correct, A5 is displayed in the "Response" field at the bottom right.
- Click on "Calibration." The calibration window appears.
- In the upper right section of the calibration window, under "Calibration Type," choose "2-Pt Gain_B & Offset_B" calibration from the drop-down list box. The smaller graph above the list box indicates the recommended pattern of two bridge readings at the same temperature.
- Enter the number of sensor modules connected to the Mass Calibration System in the "# ASICs" field.
- Click on "Initialize" in the ASIC ID section (lower left corner). A dialog box results. Choose "Digital (No Temperature)" as the output select; 25ms as the update rate; "No JFET Regulation"; normal bridge inputs (not flipped); and pre-amp gain =24. A unique identifier is assigned to each ZSC31010/ZSC31015 and is written to its EEPROM.

- Start data collection. Normally this would be done with a real bridge attached to the ZSC31010/ZSC31015 on a remote board in a controlled chamber. Instead, this dry run calibration uses the Sensor Replacement Board MCR as bridge inputs.
- Enter 10% in the “Measure %” box in the “Calibration Controls” section. For this lower value, the shorted K3 jumper provides a 0mV input to the IC.
- Click on “Add New Point.” The software obtains a raw reading from each of the parts and graphs the new data point for the currently selected DUT.
- Open the K3 jumper on the MCR (see Figure 2.6); this corresponds to the input voltage of about 38mV.
- Enter 90% in the “Measure %” box.
- Click on “Add New Point” again. The software obtains a new raw reading from each of the parts and graphs the new data point.
- Because this is a 2-point calibration, the software has all the necessary data for calculating and writing the coefficients. Click on “Calculate,” which should now be active.
- Close the calibration window and check for the correct values in the main menu display for each MCR as described above Figure 3.5 or open the *CalibrationLog_DDMMYYYY.txt* file. For each calibration point an error is recalculated as the difference between the target value and the correction using the calibration coefficients.

4 SSC Evaluation Software with the IDT SSC Terminal

4.1. Protocol

The microcontroller (type Atmega32) on the CB enables communication with the IDT Mass Calibration Board/ZSC31010/ZSC31015 using the evaluation software running on the PC. The serial ZACwire™ protocol is implemented in the microcontroller’s software. The USB_UART IC on the CB transfers the signals from the microcontroller to the USB port of the PC.

See *ZSC31xxx_ZSSC3xxx_CommunicationBoard_VX-x_DataSheet_Rev_X_x.pdf* and *ZSC3xxxxCommandSyntax.xls* for more details.

4.2. IDT SSC Terminal

The IDT SSC Terminal is the lowest level of communication for transferring commands from the PC to the microcontroller on the CB. A full summary and detailed command description of the applicable controller commands are given in *ZSC3xxx_ZSSC3xxx_CommandSyntax_Rev_2_20.xls*

Install the *SSC Terminal V201.exe* from the SSC DVD, which will create a *ZMDI SSC Terminal* icon on the PC desktop. Click on this icon to activate the terminal program. For ZSC31010+15 communication mode, “ZACWire” must be used. All communication packets between the PC and the ZSC31010/ZSC31015 begin with a leading “R.”

Table 4.1 IDT SSC Terminal Command Format

Character number	1	2	3	_ or z	4,5	6	:	<d...d>
MCB	x	0-7,9	c		1-24,99	0 or 1		'x' or SSC Command
Comment		Board number 9=all		“_” Triggering is caused by activating the ICs “z” activate ZACwire™	DUT number 99=all DUTs	0 → Turn Power OFF 1 → Turn Power ON		
Example	x	0w	c	_	23	1	:	rw_000025000

Note: Do not use “T” on the 3rd position for the ZSC31010/ZSC31015 with the MCB.

Figure 4.1 shows a communication example. Write the command in the input line and press ENTER on the keyboard or click on “Send.”

Figure 4.1 SSC Terminal Example

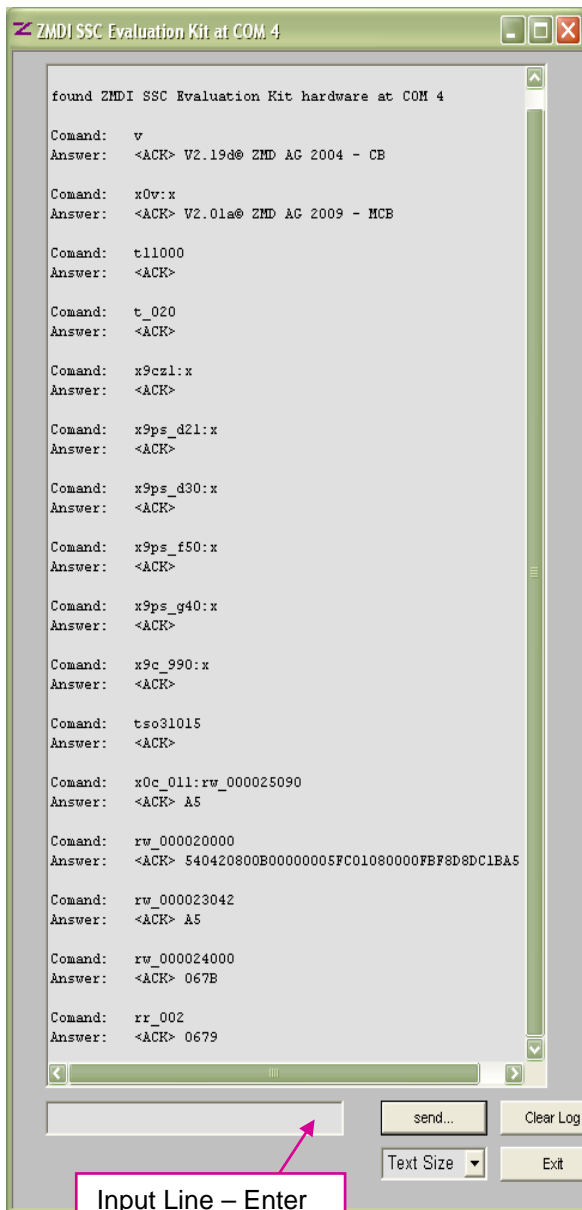

v	Read firmware version of CB
x0v:x	Read MCB firmware
t11000	Set timing trigger for 5V, 12V to 0ms
t_020	Set timing for switching supply off to 20ms off before trigger restarts IC
x9cz1:x	Activate ZACwire™ for all DUTs
x0ps_d21:x	Set signals for interface multiplexer
x0ps_d30:x	to select ZACwire interface
x0ps_f50:x	Disable 'strong pull up' option on MCB
x0ps_g40:x	Disable 'high-cap drive' option on MCB
x9c_990:x	Close communication channel for all connected DUT's
tso31015	Enable short start-up window if ZSC31015 is connected to MCB. Note: Not necessary when using the ZSC31010.
x0c_011:rw_000025090	Power ON DUT 1 on MCB 1 and Start Command Mode
rw_000020000	Read EEPROM (for number and order of the returned bytes, see data sheet)
rw_000023042	Set update rate to 25ms(40Hz) (See the data sheet for command details)
rw_000024000	Start Normal Operation Mode
rr_002	Read 2 bytes output (bridge high, bridge low)

5 Related Documents

Kit Documents
<i>SSC Mass Calibration System Feature Sheet – Rev X.x</i> (includes ordering codes and price information)
<i>SSC Communication Board Datasheet – Rev X.x</i>
<i>SSC Sensor Replacement Board Datasheet – Rev X.x</i>
<i>SSC Communication Board Driver Installation Application Note – Rev X.x</i>
<i>SSC Evaluation Kits Feature Sheet</i> (includes ordering codes and price information)
<i>ZSC31010+15 SSC Modular Evaluation Kit</i>
<i>ZSC3xxxx Command Syntax Spreadsheet – Rev X</i>
ZSC31010 Documents
<i>ZSC31010 RBiC_{Lite}TM Datasheet</i>
<i>ZSC31010 RBiC_{Lite}TM Errata Sheet – Rev X</i>
<i>ZSC31010 RBiC_{Lite}TM Application Notes – Calibration Sequence, DLL and EXE</i>
<i>ZSC31010 RBiC_{Lite}TM Technical Notes - Die Dimensions and Pad Coordinates</i>
<i>ZSC31010 RBiC_{Lite}TM AFE Configuration Selection Spreadsheet</i>
ZSC31015 Documents
<i>ZSC31015 RBiC_{dLite}TM Datasheet</i>
<i>ZSC31015 RBiC_{dLite}TM Errata Sheet – Rev X</i>
<i>ZSC31015 RBiC_{Lite}TM Application Notes – Calibration Sequence, DLL and EXE</i>
<i>ZSC31015 RBiC_{dLite}TM Technical Notes - Die Dimensions and Pad Coordinates</i>
<i>ZSC31015 RBiC_{dLite}TM AFE Configuration Selection Spreadsheet</i>

Visit IDT's website www.IDT.com or contact your nearest sales office for the latest version of these documents.

6 Definitions of Acronyms

Term	Description
ADC	Analog-to-Digital Converter
A2D	Analog-to-Digital (Converter)
CM	Command Mode
DUT	Device Under Test
MCB	Mass Calibration Board
MCR	Mass Calibration Reference Board
MCS	Mass Calibration System
NOM	Normal Operation Mode
OWI	One-Wire Interface
SSC	Sensor Signal Conditioner
SSC CB	SSC Communication Board
ADC	Analog-to-Digital Converter

7 Document Revision History

Revision	Date	Description
1.4	13-Jul-09	Folder changes for software installation and saving the corresponding text files (since revision 1.940). Revisions due to MCB V2.1 hardware/firmware changes. Revised web address and sales contacts.
1.5	28-Oct-09	Updated for software changes. Revised ZMD Far East address.
1.6	28-Jul-10	Revision of product name from ZMD31010 to ZSC31010.
1.7	17-Dec-10	Changed description and pictures according to new combined software for both ZSC31010 and ZSC31015. Removed references to <i>caldata.txt</i> , <i>DataLog.txt</i> , and <i>SavedSettings</i> files. Added referral to the SSC Evaluation Kit documentation regarding default values files. Replaced instructions for installing virtual COM port USB drivers with a referral to <i>SSC_AN_Communication Board_Driver_Installation_Rev_X_x.pdf</i> for directions. Removed Appendix B error code list and added references to <i>ZSC31010_RBic_Lite_App_Notes_Calibration_DLL+EXE_revX.X.pdf</i> .
	01-Apr-16	Changed to IDT branding.

