

ZSSC3230 SSC

Description

The ZSSC3230 SSC Evaluation Kit is designed for sensor module evaluation, laboratory setup, and module calibration development for the ZSSC3230 Sensor Signal Conditioners (SSC).

The main purpose of the ZSSC3230 Evaluation Kit is communication between the user's computer and the ZSSC3230. The computer sends commands and data via its USB port to the ZSSC3230 Evaluation Board (ZSSC3230EVB). The microcontroller on the ZSSC3230EVB interprets these commands and relays them to the ZSSC3230 located on the ZSSC3230 SSC Evaluation Board using the I2C communication interface.

The microcontroller also forwards any data bytes from the ZSSC3230 back to the computer via the USB connection. These bytes can be sensor readings to be displayed on the computer by the software, raw analog-to-digital converter (ADC) data used during calibration, or Electrically Erasable Programmable Read-Only Memory (EEPROM) data.

Kit Contents

- ZSSC3230EVB SSC Evaluation Board
- 5 samples of the ZSSC3230 (24-PQFN 4 x 4 mm)
- USB cable

ZSSC3230 SSC Evaluation Kit

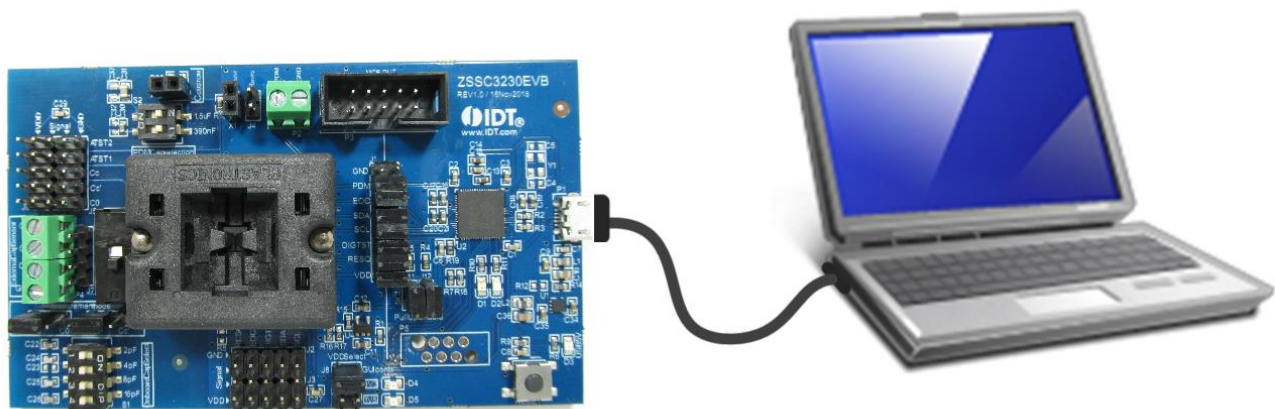

Features

- The I2C communication interface enables quick and easy configuration and calibration of the ZSSC3230 using the user's computer.
- Connections are provided on the ZSSC3230 SSC Evaluation Board for the user's sensor module, which can be used instead of the Onboard Cap Select Dual In-line Package (DIP) switches on the ZSSC3230EVB.
- A set of DIP switches on the ZSSC3230EVB controls a capacitance that simulates a sensor signal ranging from 2pF to 30pF, which can be input to the analog front-end of the ZSSC3230 for evaluation of basic features or for demonstrating a "dry-run" calibration.
- Clamshell 24-PQFN socket for ZSSC3230 device under test (DUT) facilitates testing multiple DUTs without soldering.
- Software is available for download from the Renesas web site: <https://www.renesas.com/us/en/products/sensor-products/sensor-signal-conditioners-ssc-afe/zssc3230kit-evaluation-kit-zssc3230>

Contents

1.	Setup	4
1.1	User Equipment.....	4
1.2	User Computer Requirements and Setup.....	4
1.2.1	Computer Requirements	4
1.2.2	ZSSC3230 Evaluation Software Installation and Setup.....	4
1.3	Hardware Setup.....	5
1.3.1	Overview of Hardware Connections	5
1.3.2	Kit Hardware Connections and Power-up.....	5
1.4	Communication Setup	9
1.5	Data Save and Upload	10
1.6	Tools.....	11
2.	Usage Guide.....	12
2.1	IC STATUS.....	12
2.2	I/O FUNCTIONS.....	12
2.3	“MAIN” Application Tab	13
2.4	“CONFIGURE” Application Tab.....	15
2.4.1	SIGNAL CONDITIONING.....	15
2.4.2	AFE CONFIG.....	16
2.4.3	APPLICATION.....	18
2.5	“CALIBRATION” Application Tab	19
2.6	“MEMORY EDIT” Application Tab	20
2.7	“COMMAND CONSOLE” Application Tab.....	21
3.	Example of Configuration and Calibration Procedures.....	23
3.1	Setup and Initialization	23
3.2	Data Collection	23
3.3	Coefficients Calculation	27
3.4	Memory Programming.....	27
3.5	Verification.....	30
4.	Schematics and Signal Connections between Boards	31
5.	Bill of Materials (BOM).....	33
6.	Board Layout	35
7.	Related Documents and Software.....	35
8.	Glossary	36
9.	Ordering Information.....	37
10.	Revision History.....	37

List of Figures

Figure 1.	Pin 1 Location in the PQFN Socket	5
Figure 2.	VDD Select Jumper Location	6
Figure 3.	External Cap Sensor Connection	6
Figure 4.	Hardware Connections	6
Figure 5.	ZSSC3230 SSC Evaluation Board – Overview	7
Figure 6.	Initial Display	9
Figure 7.	Settings Menu.....	9
Figure 8.	Save Configuration Dialog Window	10
Figure 9.	FILE Menu Options.....	10
Figure 10.	TOOLS Menu Options	11
Figure 11.	Sensor Readings on the “MAIN” Tab	13
Figure 12.	Sensor Readings on the “MAIN” Tab – Oversampling Input Data.....	14
Figure 13.	The “CONFIGURE” Tab	15
Figure 14.	“SIGNAL CONDITIONING” Sub-tab	16
Figure 15.	“AFE CONFIG” Sub-tab.....	17
Figure 16.	“APPLICATION” Sub-tab.....	18
Figure 17.	Sensor Calibration Using the “CALIBRATION” Tab	19
Figure 18.	“MEMORY EDIT” Tab.....	20
Figure 19.	“COMMAND CONSOLE” Tab	21
Figure 20.	Calibration Type Options.....	24
Figure 21.	Calibration Points Settings	25
Figure 22.	S2 Reading and Get Value for Calibration	26
Figure 23.	S1 Reading and Get Value for Calibration	26
Figure 24.	Coefficients Calculation.....	27
Figure 25.	Coefficients in Memory Map.....	28
Figure 26.	Steps on Calibration Tab.....	29
Figure 27.	Calibrated Sensor Measurement.....	30
Figure 28.	ZSSC3230 Evaluation Board Schematic.....	31
Figure 29.	ZSSC3230 Evaluation Board – Layout.....	35

List of Tables

Table 1.	ZSSC3230 Evaluation Board Connectors, Switches, and LEDs	7
Table 2.	IC Status Indicators When Virtual LED is Yellow.....	12
Table 3.	I/O Function Buttons.....	12
Table 4.	Sub-Tabs Under the “CONFIGURATION” Tab.....	15
Table 5.	Available Commands for Command Console.....	21

1. Setup

1.1 User Equipment

A Windows®-based computer is required for interfacing with the kit and configuring the ZSSC3230.

1.2 User Computer Requirements and Setup

1.2.1 Computer Requirements

Note: The user must have administrative rights on the computer to download and install the ZSSC3230 Evaluation Software for the kit.

The computer must meet the following requirements:

- Windows® 7, 8, 8.1, 10
- Microsoft® .NET Framework 4.0 or higher
- Supported architecture: x86 and x64
- USB port
- Internet access to download the install setup

1.2.2 ZSSC3230 Evaluation Software Installation and Setup

The latest version of ZSSC3230 Evaluation Software, which is required for the kit, must be downloaded from the Renesas web site at <https://www.renesas.com/us/en/products/sensor-products/sensor-signal-conditioners-ssc-afe/zssc3230kit-evaluation-kit-zssc3230>

Note: FTDI USB drivers are needed only for backwards compatibility with older Renesas communication hardware. If these drivers are not already installed on the user's computer, the software automatically installs the correct drivers after user confirmation.

Follow these procedures to install the Evaluation Kit Software on the user's computer:

1. Downloading and extract the contents of the zip file to the user's computer.
2. Double click on the extracted *setup.exe* file.
3. Follow the resulting standard installation instructions displayed on the screen, changing the installation path if needed.
If the default path setting is used, the software automatically completes the installation and creates an access link on the user's computer under *Start > All Programs > Renesas > ZSSC3230 Evaluation*.
The installation dialog offers the option to create a desktop short-cut icon for the software if selected.
4. Connect the kit hardware as described in section 1.3 before starting the software program for the first time.
See section 1.4 for additional software setup and usage.

1.3 Hardware Setup

1.3.1 Overview of Hardware Connections

The ZSSC3230 Evaluation Kit contains the hardware needed for communication and application of the ZSSC3230 sensor signal conditioning ICs. The user can run the software to communicate with the ZSSC3230 DUT via the ZSSC3230EVB Evaluation Board connected to the user's computer through a USB cable.

The Onboard Cap Select DIP switch on the ZSSC3230EVB can be used as a replacement for an actual sensor. Alternatively, the user's sensor module can be connected to the ZSSC3230EVB for configuration, calibration, and evaluation as an aid to module development.

The ZSSC3230 supply voltage (VDD) is provided from the ZSSC3230EVB power supply. VDD can be set to 1.8V or 3.3V by a jumper setting or by a setting in the GUI of the evaluation software.

Upon delivery, there is a ZSSC3230 IC in the socket on the ZSSC3230 SSC Evaluation Board that is pre-configured for use with the ZSSC3230 Evaluation Kit.

1.3.2 Kit Hardware Connections and Power-up

Follow these procedures to set up the kit hardware:

1. Install the ZSSC3230 DUT in the PQFN socket on the ZSSC3230 SSC Evaluation Board (ZSSC3230EVB), see the red arrow on Figure 1 for pin 1 orientation.
Note that if the DUT is not configured completely, a "Memory Error" is popped (see Table 2 for details).
2. Place a jumper shunt across the "GUI contr." position on the "VDD Select" connector header on the ZSSC3230EVB (see the red arrow on Figure 2).
Or
Apply the shunt in either the "3V3" or "1V8" position on the "VDD Select" header for manual voltage selection.
3. Ensure that all pins except for DIGTST on J1 are shorted.
4. If using the on board capacitors, configure the SW2 "CAP" switch to the "Onboard" setting, see Figure 28 for the ZSSC3230 Evaluation Board schematic
Or
If using the customer's sensor module, connect the module to the "External Cap Sensor" connector shown in Figure 3.
Both P4 and J7 can be used as connection points, see Figure 28 for the ZSSC3230 Evaluation Board schematic.
5. Connect the USB cable from the USB connector on the ZSSC3230EVB to an available USB port on the user's computer.

Figure 1. Pin 1 Location in the PQFN Socket

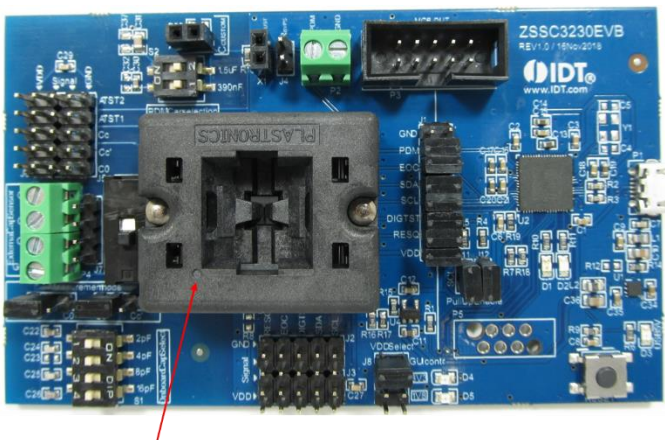

Figure 2. VDD Select Jumper Location

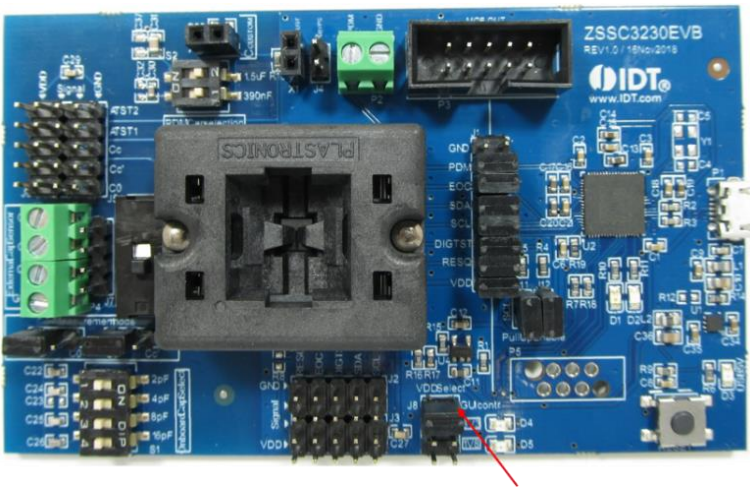

Figure 3. External Cap Sensor Connection

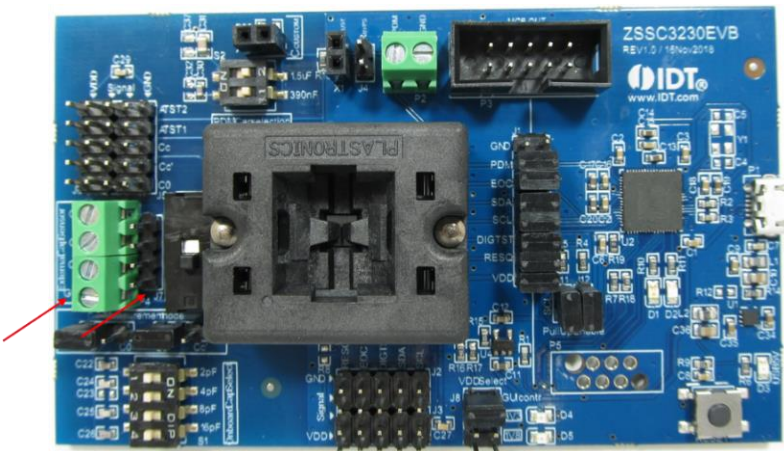

Figure 4. Hardware Connections



Figure 5. ZSSC3230 SSC Evaluation Board – Overview

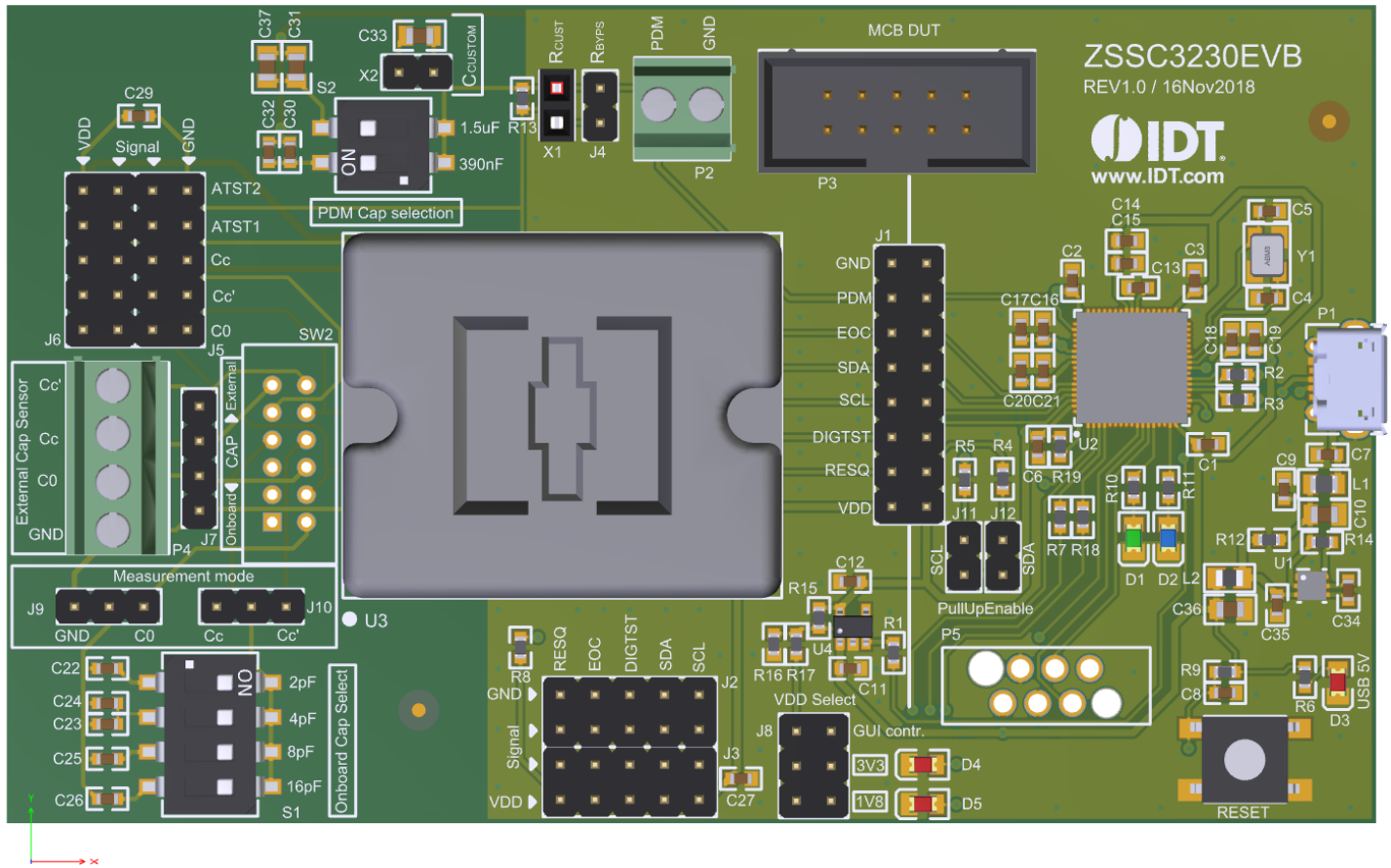

Table 1. ZSSC3230 Evaluation Board Connectors, Switches, and LEDs

Name	Description
P1	USB Connector
P2	Screw terminal for Pulse Density Modulation (PDM) signal measurement
P3	Mass Calibration Board (MCB) DUT connector. Contact Renesas for further information.
P4	External Cap Select – Screw terminal to connect external capacitive sensor
P5	Debug header
D1	Firmware Update Status LED
D2	Status LED
D3	Status LED for the USB power supply
D4	Status LED for the 3.3V Supply
D5	Status LED for the 1.8V Supply
J1	Header to connect/disconnect the MCU from the Sensor Signal Conditioner (SSC)
J2, J3, J5, J6	Header strips for access to all ZSSC3230 signals. Each connector also provides access to VDD or GND.

Name	Description
J4	Rbyps – PDM output setting
J7	Header to connect external capacitive sensor
J8	VDD Select header
J9, J10	Measurement Mode selection
J11, J12	Pull-up Enable for I2C communication lines
S1	Onboard Cap Select
S2	PDM Cap Selection
RESET	Reset button for the MCU
SW2	Onboard/External Cap Switch
X1	Rcust – PDM output setting
X2	Ccust – PDM output setting
U3	Socket for inserting the 24-PQFN 4mm x 4mm ZSSC3230 DUT.

1.4 Communication Setup

Once the Evaluation Board is connected and powered via USB, start the ZSSC3230 Evaluation Software. The window opens with the “MAIN” application tab displayed (see Figure 6). Multiple devices can be connected to the user’s computer; active, correctly connected devices, including the ZSSC3230EVB are listed under “ACTIVE BOARDS”.

Follow these steps to set up communication with the kit:

1. Click on the device in the “ACTIVE BOARDS” list.
Click Refresh after changing any connections.

Figure 6. Initial Display



2. Select a VDD option from “CONNECTION” drop-down list, see Figure 6.
Note that this option only applies if the VDD Select jumper is in the “GUI Contr.” position.
3. If necessary, configure the I2C communications and specific settings, such as speed and the slave address, via the “SETTINGS” drop-down list (see Figure 7).
The settings are applied when a connection is re-established with the ZSSC3230.
Note that the I2C address must be set correctly in order to establish successful I2C communication.

Figure 7. Settings Menu

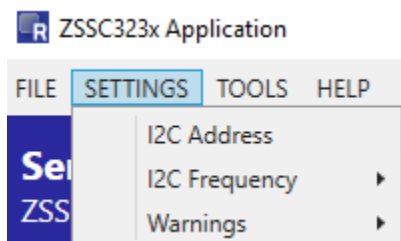

- Click “Connect” to establish communication with the ZSSC3230.
When communication is correctly established, the “Connect” button changes to “Disconnect.” The software generates the corresponding data frame structure with values by default.

When the Evaluation Software is closed, the “Save Configuration Settings” window pops up. By clicking “Yes”, the current configuration of the GUI is saved in a *.cfg file and it is loaded automatically next time the software is opened.

Figure 8. Save Configuration Dialog Window

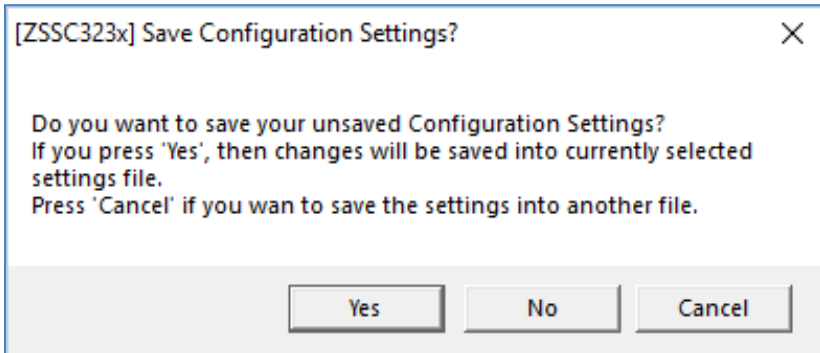

1.5 Data Save and Upload

Clicking on the “FILE” menu, see Figure 9, the following options will be provided:

- Configuration

GUI configuration (for example, I2C speed) can be saved, reloaded from a saved file and saved on file (*.cfgx)

- NVM

NVM content can be saved on file (*.dmpx), loaded from a previously saved file, loaded with the default configuration overwriting the current one.

- Calibration Data

Data defining the calibration of the device can be saved on file (*.cdmpx) or can be uploaded from a previously saved file (*.cdmpx)

Figure 9. FILE Menu Options

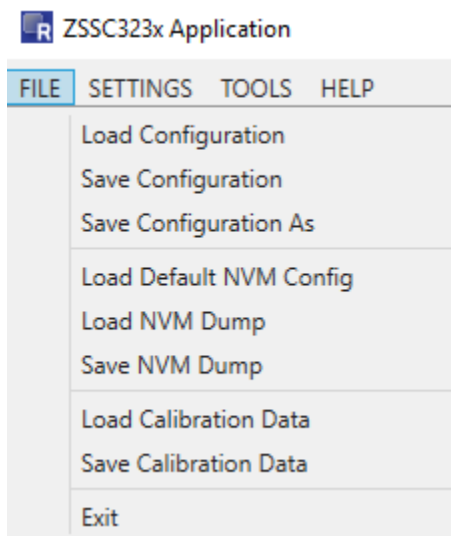

1.6 Tools

Clicking on the “TOOLS” menu, see Figure 10, the following options will be provided:

1. Open the Log file communication, error, calibration
2. Open the Log file folder

Figure 10. TOOLS Menu Options

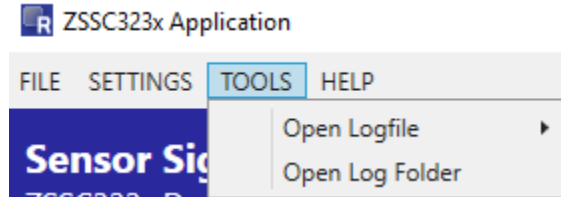

2. Usage Guide

The ZSSC3230 Evaluation Software is intended for demonstration purposes and calibration of single units. Upon request, Renesas can provide algorithms and assistance in developing a full production calibration software.

Note: The reset button on the ZSSC3230EVB (see Figure 5) initializes the CB controller to its initial state.

2.1 IC STATUS

Click the “Read status” in the “IC STATUS” menu to read the current IC-status (see Figure 6). It is provided in any read sequence from the slave in the first byte, and the status of the device is indicated by the color of the virtual LEDs:

- Yellow indicates that the according bit in the status byte is ‘1’
- White indicates that the according bit in the status byte is ‘0’

Table 2. IC Status Indicators When Virtual LED is Yellow

Control	Virtual LED Indication
Powered	The ZSSC3230 is powered.
Busy	The ZSSC3230 is processing the recent inquiry, for example, a measurement command.
Normal Mode	The ZSSC3230 is in Normal Mode (NOM).
CMD Mode	The ZSSC3230 is in Command Mode (CMD Mode).
Mem Error	The CRC-value in register 0x1C do not comply with the memory content. Important note: Upon first use of an un-configured ZSSC3230, this virtual LED is yellow. To clear the initial error indicator, write data to memory (that is sensor configuration, coefficients) and generate the signature of the memory contents via the “Write NVM + CRC” button in the I/O FUNCTION menu (see section 2.2 for details). The settings for this initial memory write operation can be random because these registers are overwritten as part of the configuration and calibration procedures.
ADC Overflow	An error has occurred due to ADC overflow.
ALU Saturation	An error has occurred due saturation of the internal Arithmetic Logic Unit (ALU).

2.2 I/O FUNCTIONS

Table 3. I/O Function Buttons

Button	Description
Read NVM	Reads the EEPROM contents of the ZSSC3230 and updates all GUI elements with the new values.
Write NVM + CRC	Writes all changes of the configuration to the EEPROM of the ZSSC3230. Recalculates and stores a new CRC value.
Start CM	Forcing the ZSSC3230 to enter CMD Mode. This button is available when the ZSSC3230 is in NOM.
Start NOM	Forcing the ZSSC3230 to enter NOM. This button is available when the ZSSC3230 is in CMD Mode.
Stop PDM	Stops the PDM output of the ZSSC3230 to use the I2C communication interface to configure it.
Reset IC	Toggles the RESQ pin to reset the ZSSC3230 and enables the PWM output if it is configured in the EEPROM.

2.3 “MAIN” Application Tab

Click the “Start” button on the “MAIN” application tab (Figure 11) to display the readings for “Sensor” and “Temperature”. By default, data is displayed as raw value (hexadecimal). The numerical format (hexadecimal or decimal) is selected by clicking the small blue stripe on the left of the data display box (Figure 11).

The graphical representation of the data received from the sensors shows the variations of the read values: the data shown in red is for the capacitive sensor and the data in blue is for the temperature. The data scale for temperature output is on the right of the main graph; the scale for bridge sensor measurements is on the left. The auto-scalable x-axis represents the number of measurement points at a given value in a run.

Figure 11. Sensor Readings on the “MAIN” Tab

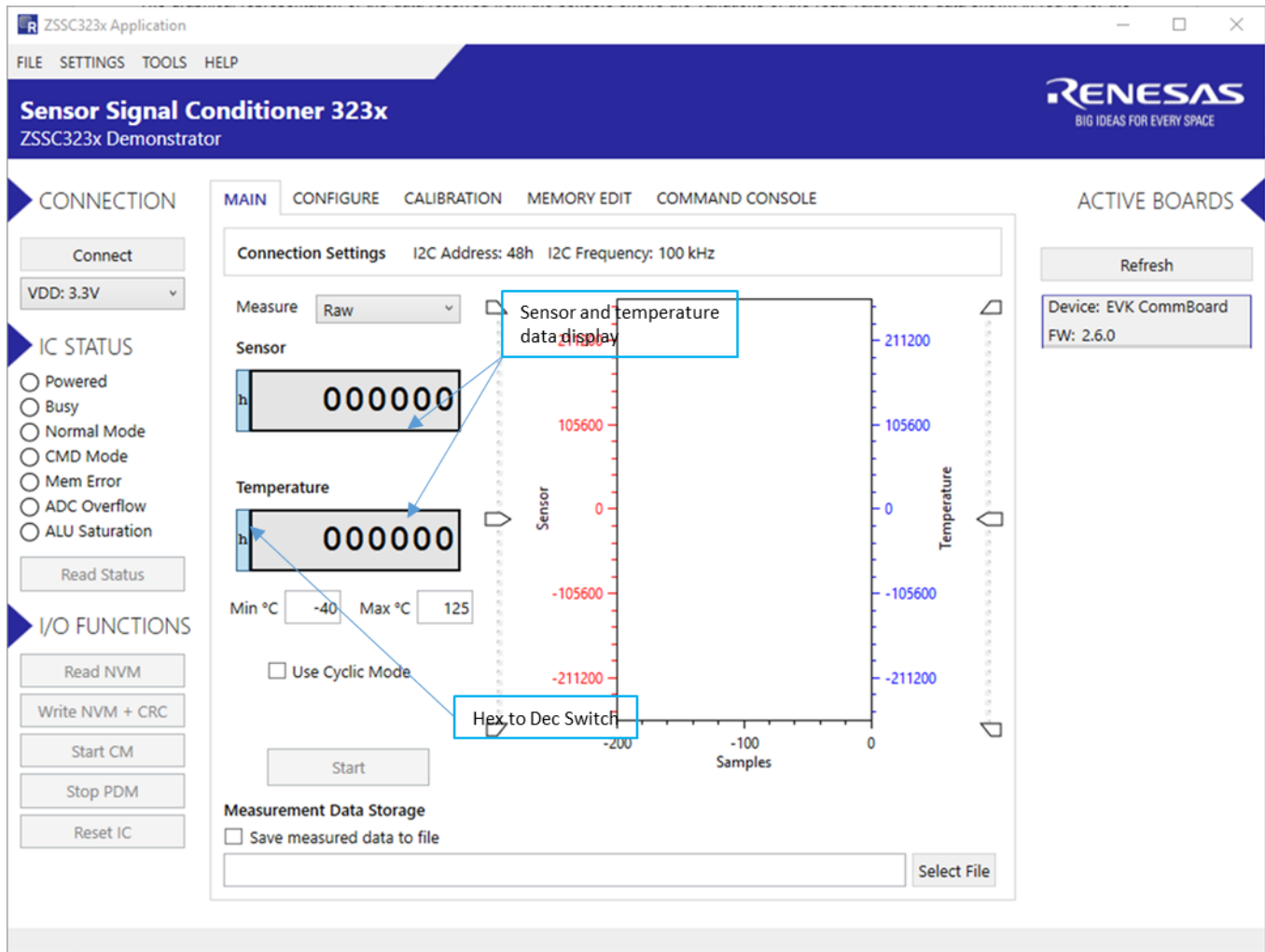

Check the “Use Cyclic Mode” box to enable autonomous, cyclically repeated sensor measurements and related digital and output updates. Cyclic mode activation turns the Sensor data display to % (capacitive sensor) and to °C (temperature sensor).

Oversample drop-down list is displayed when “Use Cyclic Mode” is not activated, and % or °C is selected using the radio button (see Figure 12). Use oversample measurements to obtain noise-minimized measurement results. With higher oversampling factors, the command execution time increases proportionally.

Figure 12. Sensor Readings on the “MAIN” Tab – Oversampling Input Data



2.4 “CONFIGURE” Application Tab

The “CONFIGURE” application tab has three sub-tabs for different settings as described in Table 4. Figure 13 is an example showing the “SIGNAL CONDITIONING” sub-tab. Refer the ZSSC3230 *Data Sheet* for further details about the settings, see section 7.

Figure 13. The “CONFIGURE” Tab

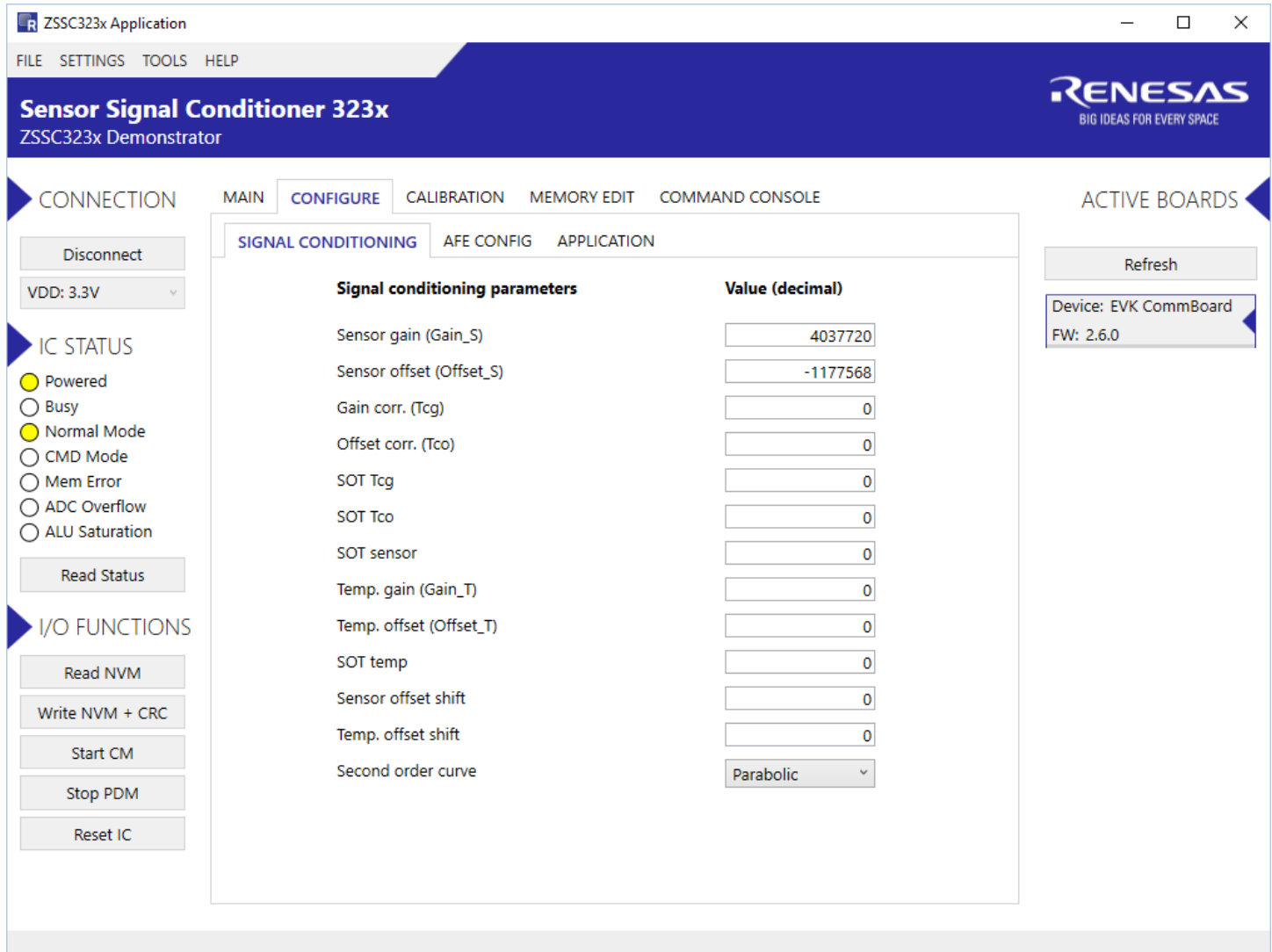

Table 4. Sub-Tabs Under the “CONFIGURATION” Tab

Sub-tab	Description
SIGNAL CONDITIONING	Provides settings for signal conditioning parameters in decimal values.
AFE CONFIG	Provides settings for parameters for the measurement configuration.
APPLICATION	Provides settings for parameters for the application configuration.

2.4.1 SIGNAL CONDITIONING

In the “SIGNAL CONDITIONING” sub-tab (see Figure 14), all necessary coefficients for signal processing are stored; for example, gain, offset, and temperature compensation. Initial values are 0; the calibration procedure must be performed in order to set these parameters.

Figure 14. “SIGNAL CONDITIONING” Sub-Tab

Signal conditioning parameters	Value (decimal)
Sensor gain (Gain_S)	<input type="text" value="3857478"/>
Sensor offset (Offset_S)	<input type="text" value="-1026308"/>
Gain corr. (Tcg)	<input type="text" value="0"/>
Offset corr. (Tco)	<input type="text" value="0"/>
SOT Tcg	<input type="text" value="0"/>
SOT Tco	<input type="text" value="0"/>
SOT sensor	<input type="text" value="0"/>
Temp. gain (Gain_T)	<input type="text" value="0"/>
Temp. offset (Offset_T)	<input type="text" value="0"/>
SOT temp	<input type="text" value="0"/>
Sensor offset shift	<input type="text" value="0"/>
Temp. offset shift	<input type="text" value="0"/>
Second order curve	<input type="text" value="Parabolic"/>

2.4.2 AFE CONFIG

The “AFE CONFIG” sub-tab (see Figure 15) sets different parameters of the analog front-end (AFE) of the ZSSC3230; for example, gain, zero shift offset, and ADC resolution.

Figure 15. “AFE CONFIG” Sub-tab

MAIN **CONFIGURE** CALIBRATION MEMORY EDIT COMMAND CONSOLE

SIGNAL CONDITIONING **AFE CONFIG** APPLICATION

Measurement configuration	Value
Cap Range [Max C Signal Input Range]	16.0pF
Zero Shift Capacitance	3.00pF
ADC Conversion Bits	16
Noise Mode	"Pressure 16bit"
Sensor Leakage Compensation	disabled
Senscap Type	single ended

Sensor Input Pin	CC
Dithering	enabled
Subtraction Mode	disabled
Active Shield Drive	disabled
High Current Mode	disabled

2.4.3 APPLICATION

The “APPLICATION” sub-tab (see Figure 16) allows setting two 16-bit customer ID values, the sensor threshold limits (24-bit), the cycle update period, I2C slave address and various other application settings.

Figure 16. “APPLICATION” Sub-tab

Application parameters	Value (decimal)
Customer ID0	<input type="text" value="65535"/>
Customer ID1	<input type="text" value="65535"/>
Interrupt threshold 1 (TRSH1)	<input type="text" value="0"/>
Interrupt threshold 2 (TRSH2)	<input type="text" value="0"/>
Update period in cyclic operation	<input type="text" value="no delay"/>
EOC pin interrupt configuration	<input type="text" value="EoC signal"/>
PDM Output	<input type="text" value="disabled"/>
Signal Inversion	<input type="text" value="disabled"/>
User Memory 0 (10bit)	<input type="text" value="0"/>
User Memory 1	<input type="text" value="43681"/>
User Memory 2	<input type="text" value="6"/>
I2C Slave Address	<input type="text" value="h 48"/>

2.5 “CALIBRATION” Application Tab

The “CALIBRATION” tab is used for acquiring raw data and calculating the coefficients needed for signal linearization and temperature compensation.

The selected type of calibration defines the number of measurement points for the sensor signal at various temperatures (if temperature compensation is selected).

The corrected output signal, which is calculated using the coefficients, targets the % reference value relevant to the input sensor signal. For example, in Figure 17, a certain capacitive sensor input resulting in a raw measurement output of 23255 counts (16-bit resolution) is assigned to 10% of the full scale of $2^{24}-1$ after calibration. This means that the same sensor input, with the calculated coefficients, is always resulted in a corrected output of $10/100 \times 2^{24}-1 = 1\,677\,721$ counts.

Figure 17. Sensor Calibration Using the “CALIBRATION” Tab

Calibration Type Settings

Type: 2 Points: S(O+G) | Curve: Parabolic

Temperature range

Min: -40 °C | Max: 125 °C

Acquisition Settings

Skip the first: 0 samples | Average: 1 samples

Calibration points

Sensor Targets [%]	Raw Counts
S2: 90	[blank]
S3: [blank]	[blank]
S1: 10	23255

Temp [°C]

T2: [blank] | T1: [blank] | T3: [blank]

Buttons: Calculate coefficients, Write coefficients to NVM, Write coefficients to IC, Save CSV

Coefficient result

RESULT	Offset S	Gain S	Tcg	Tco	SOT Tco	SOT Tcg	SOT S	Offset T	Gain T	SOT T
SUCCESS	-1177568	4037720								

2.6 “MEMORY EDIT” Application Tab

The “MEMORY EDIT” tab (see Figure 18) shows the current state of the ZSSC3230 memory. It allows the user to edit and write memory contents with an automatically generated CRC. Writing new values directly to the memory can be done in the grid box in the correct address for the new value. After the data is entered, the new content must be updated in the ZSSC3230 by clicking the “Write NVM + CRC” button in the I/O FUNCTION menu. The display grid updates automatically when the configuration changes in the “CONFIGURE” and “CALIBRATION” application tabs; the values that are not yet written in the ZSSC3230 memory are shown in red. Note that these values are not written automatically in the ZSSC3230, to complete this, click the “Write NVM + CRC” button.

The data is displayed as four hexadecimal digits for each of the first 1B_{HEX} (27_{DEC}) addresses in the NVM. The final register 1C_{HEX} (28_{DEC}) contains the checksum of the entire memory contents. To display the ZSSC3230 memory contents in the table, read the complete memory by clicking on the “Read NVM” button in the I/O FUNCTION menu. The resulting message in the lower left corner in the grey shadowed bar of the window is “NVM read complete”, the message disappears after a few seconds from the memory read.

Figure 18. “MEMORY EDIT” Tab

The screenshot shows the "MEMORY EDIT" tab of the ZSSC323x Application. The main area contains a table of NVM memory addresses and their values. The value at address 10h (1234) is highlighted in red, indicating it is not yet updated in the memory. Callouts explain that "Read ZSSC3230 NVM memory" and "Write the ZSSC3230 memory CRC included" are actions that can be performed. A "Data not updated in ZSSC3230 memory" callout points to the red value. The interface also includes a menu with options like "Read NVM", "Write NVM + CRC", and "Start CM", and a status section with "IC STATUS" and "I/O FUNCTIONS".

NVM	0	1	2	3	4	5	6	7
00h	0000	0000	0048	F7E0	9C58	0000	0000	0000
08h	0000	0000	0000	0000	0000	913D	0000	0000
10h	0000	0000	1234	0000	0000	0000	0000	0000
18h	0000	FA05	6AC2	A87B	343A			

2.7 “COMMAND CONSOLE” Application Tab

On the “COMMAND CONSOLE” tab, the user can write commands directly to the ZSSC3230 and see the response in the output window. A previously edited script file can be loaded and executed directly as a command sequence by clicking the “Browse” button, selecting a file, and clicking the “Execute Script” button as shown in Figure 19. The script file must be a text file with valid commands. The output data from the ZSSC3230 can be copied and saved for further analysis by right-clicking on the results in the display.

List of the available line commands is provided in Table 5.

Figure 19. “COMMAND CONSOLE” Tab

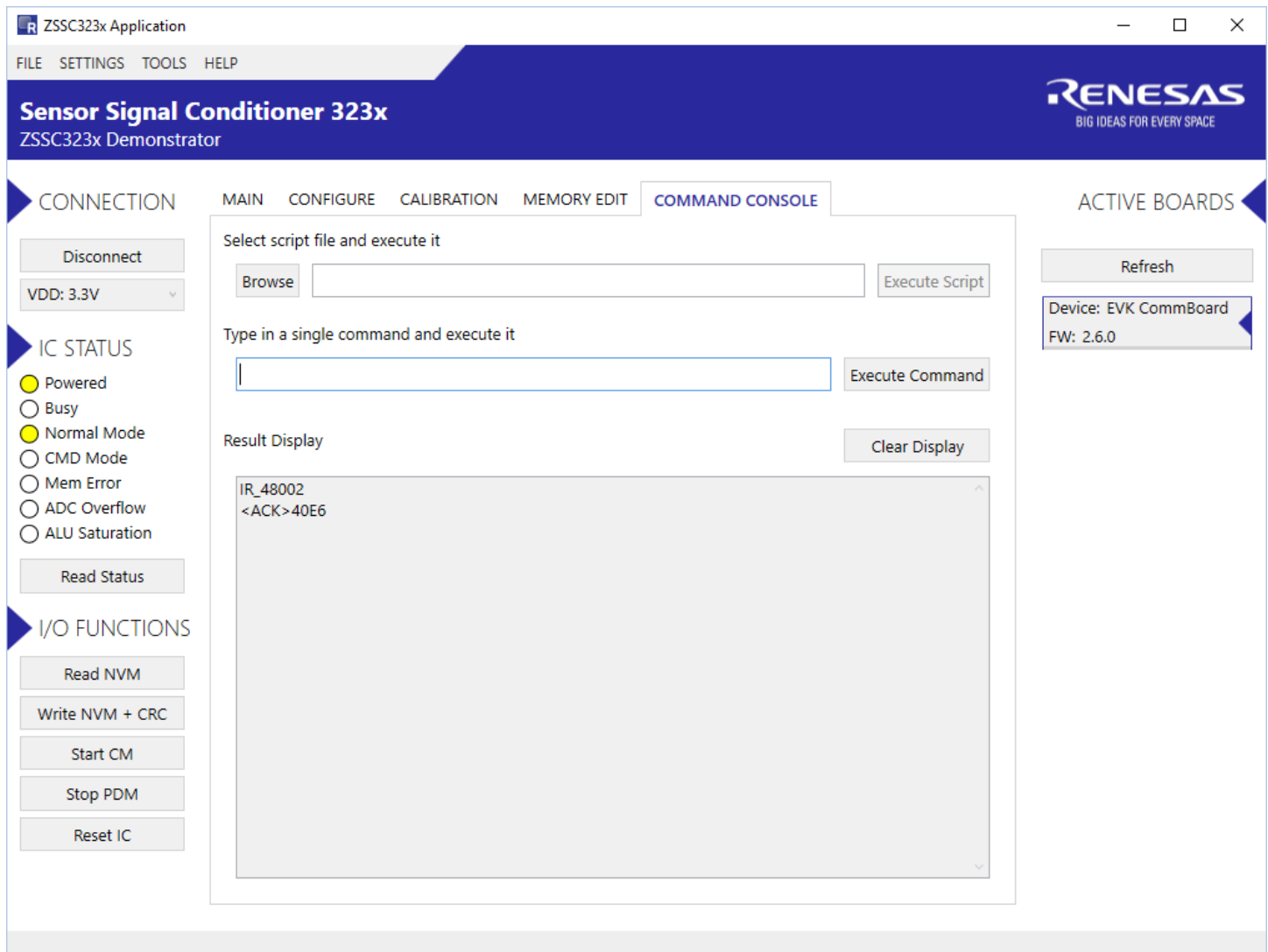

Table 5. Available Commands for Command Console

Command	Description
V	Returns the version string of the SSC Evaluation Board.
PS_E71	Performs a reset on the ZSSC3230 using its reset pin.
TWAITxxxxx	Delays a specific amount of milliseconds (ttttt - milliseconds to wait).
TWAITLISTxxxxx	Sets up the delay between the execution of the list commands (ttttt - milliseconds to wait between list commands).

Command	Description
T0000000	Powers off.
TXXXXYYY	Powers on the VDD if at least one of the X is 1. Y value is irrelevant (VDD is set to 3.3V by default, can be set to 1.8V with another command).
IS_07	Sets I2C speed to 400kHz.
IS_11	Sets I2C speed to 100kHz.
IS_10	Sets I2C speed to 50kHz.
IW_aabbbdd	Sets I2C write, where: <ul style="list-style-type: none"> ▪ aa: I2C address ▪ bbb: number of bytes to write ▪ dd: bytes to be written
IR_aabbb	Sets I2C read, where: <ul style="list-style-type: none"> ▪ aa: I2C address ▪ bbb: number of bytes to write
BOOTLOADERSTART	Starts the bootloader of the SSC Evaluation Board for FW update.
BOARDVDD3V3	Sets the VDD to 3.3V to be used when it is turned on by a TXXXXYYY command.
BOARDVDD1V8	Sets the VDD to 1.8V to be used when it is turned on by a TXXXXYYY command.
BCOMMLIBVERSION	Returns the version string of the EvkCommLib library that is used for the communication with the SSC Evaluation Board

3. Example of Configuration and Calibration Procedures

This calibration example uses the Onboard Cap Select module to emulate a sensor signal. A typical calibration flow includes the five basic steps described in the following sections: setup and initialization; data collection; coefficient calculation; memory programming; and verification. Refer to the flow diagram provided in the *ZSSC3230_Calibration* document (see section 7).

3.1 Setup and Initialization

Follow these steps for initial setup:

1. Start the GUI.
2. Ensure that the ZSSC3230EVB appears as an active device.
3. Select the supply voltage.
4. Set the I2C slave address and speed if needed.
5. Click the “Connect” button to connect to the ZSSC3230.
Wait until the correct communication is established
6. Click “Start” on the “MAIN” application tab to read the data from the Onboard Cap Select.
Note that the sensor is not calibrated by default.

Follow these steps to set the AFE configuration:

1. Select the “CONFIGURE” tab (see Figure 13) to set, for example, the gain of the PGA, number of ADC bits resolution, and offset. Refer to the *ZSSC3230 Data Sheet* for detailed descriptions of these parameters.
2. Click the “Write NVM + CRC” button in the I/O FUNCTION menu.
3. Click the “Reset IC” button in the I/O FUNCTION menu to apply the new AFE configuration to the ZSSC3230.
4. Set the “Acquisition Settings” in the “CALIBRATION” Tab (see Figure 17):
 - use the “Skip the first” to select the number of measurements to be discarded at the beginning of the measurement to avoid collecting invalid data.
 - use the “Average” to indicate the number of samples to use to calculate average values to get more coherent data.

3.2 Data Collection

The ZSSC3230 provides a set of options for digital compensation of the capacitive sensor (first and second order), and temperature sensor (first and second order). On the “CALIBRATION” tab, choose between one of the seven different types of possible calibration scenarios from the drop-down lists under “Calibration Type Settings”, see Figure 20.

Figure 20. Calibration Type Options

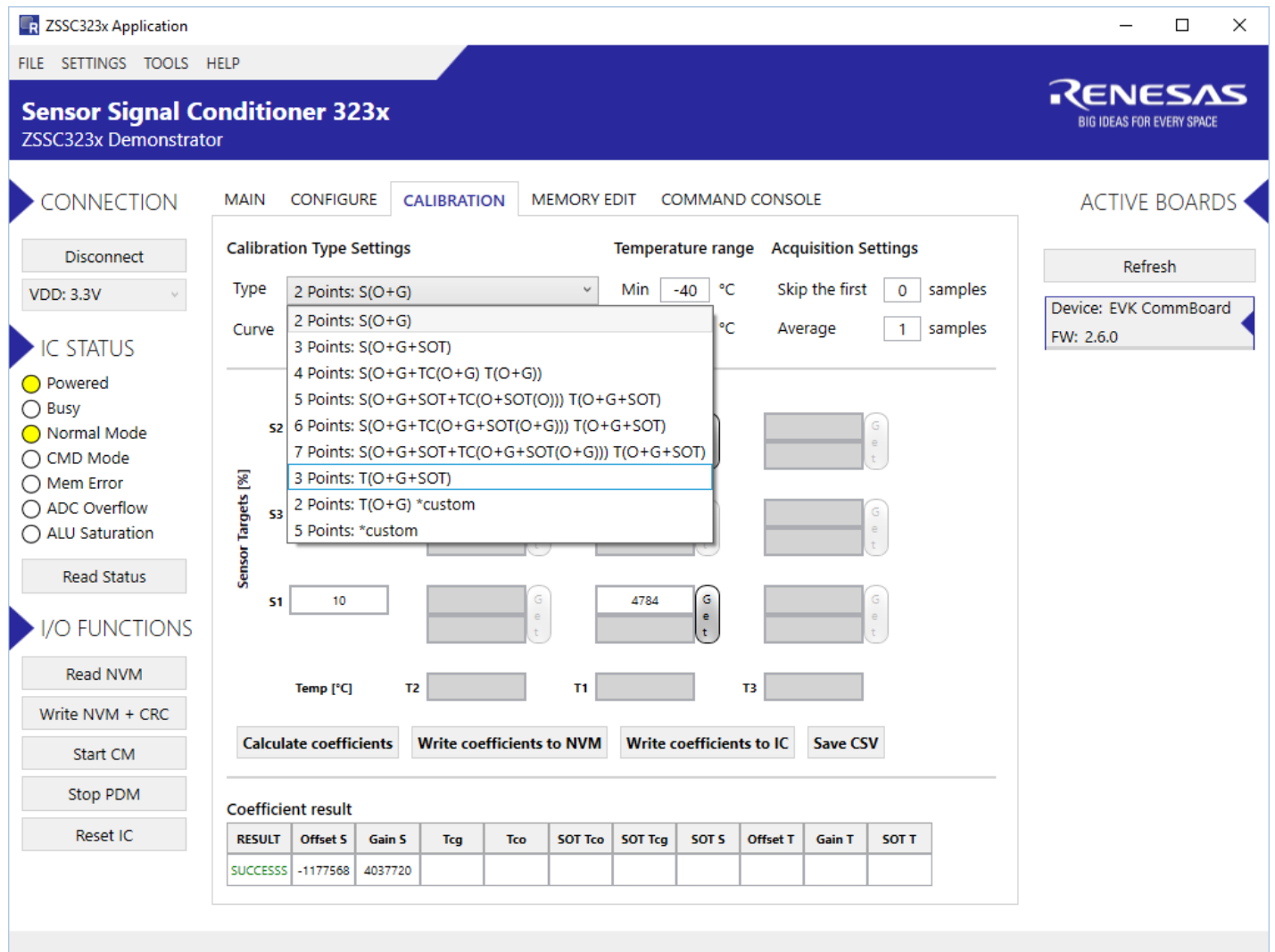

For this example, the two-point calibration without temperature compensation is used to obtain the gain and offset calibration for the simulated sensor signal from the Onboard Cap Select by the following steps:

1. Select the “2 points: S(O+G)” option from the drop-down list under “Calibration Type Settings”. This enables the “S1” and “S2” data fields in the “Sensor Targets [%]” vs “Calibration Points” matrix area. The target range of the ADC as a percentage of full scale; a recommended value is within the range of 10% and 90%. This is shown in Figure 21.

Figure 21. Calibration Points Settings

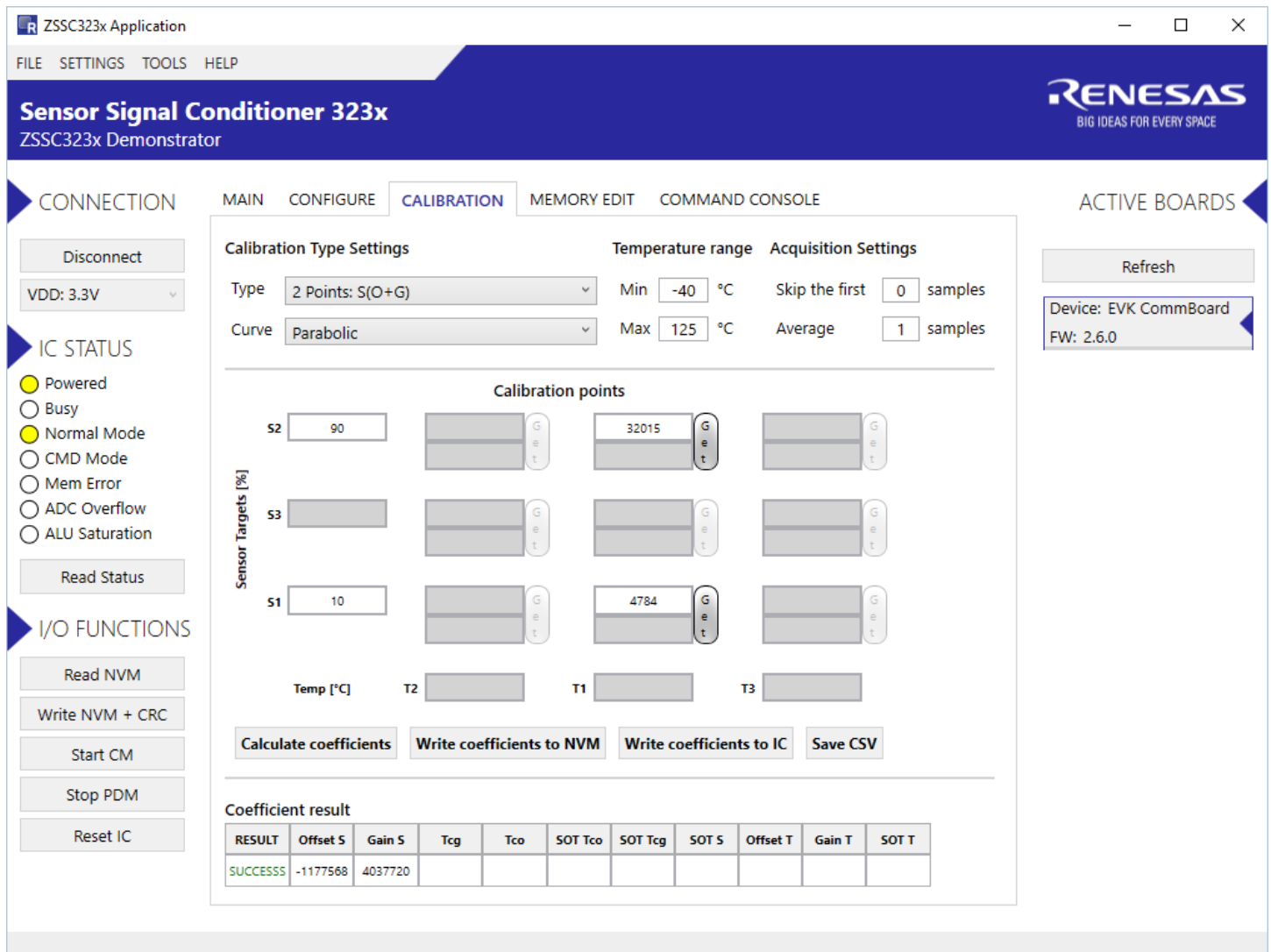

2. Click the “Get” buttons for the active fields in the “Calibration points” section to acquire data for the first and the second point as follows.
3. For point S2, adjust the Onboard Cap Select for a low measurable value (target is 10%) for the dummy sensor (DIP switch S1 configured as needed for in this case). See Figure 22 for the read value with this input capacitance.

Figure 22. S2 Reading and Get Value for Calibration

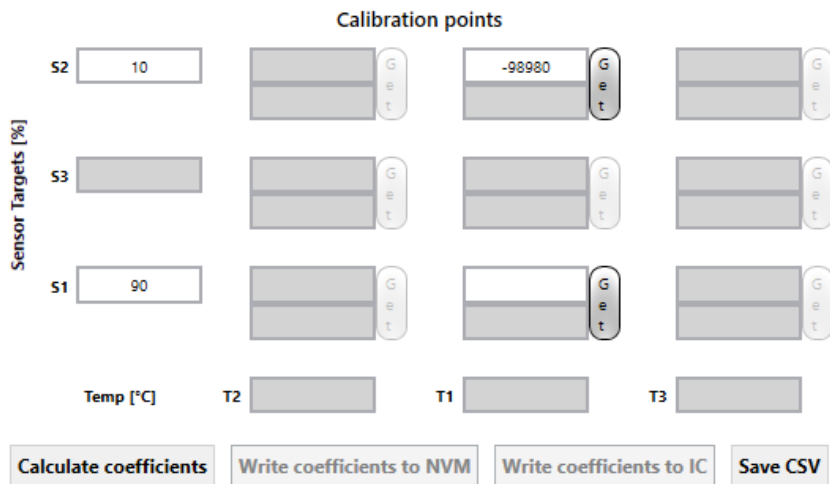

4. Set the S1 DIP switch to target a value of about 90% of the full scale for the input signal.
5. Click the “Get” button for the S1 point to obtain the second value in the calibration curve, see Figure 23.

Figure 23. S1 Reading and Get Value for Calibration

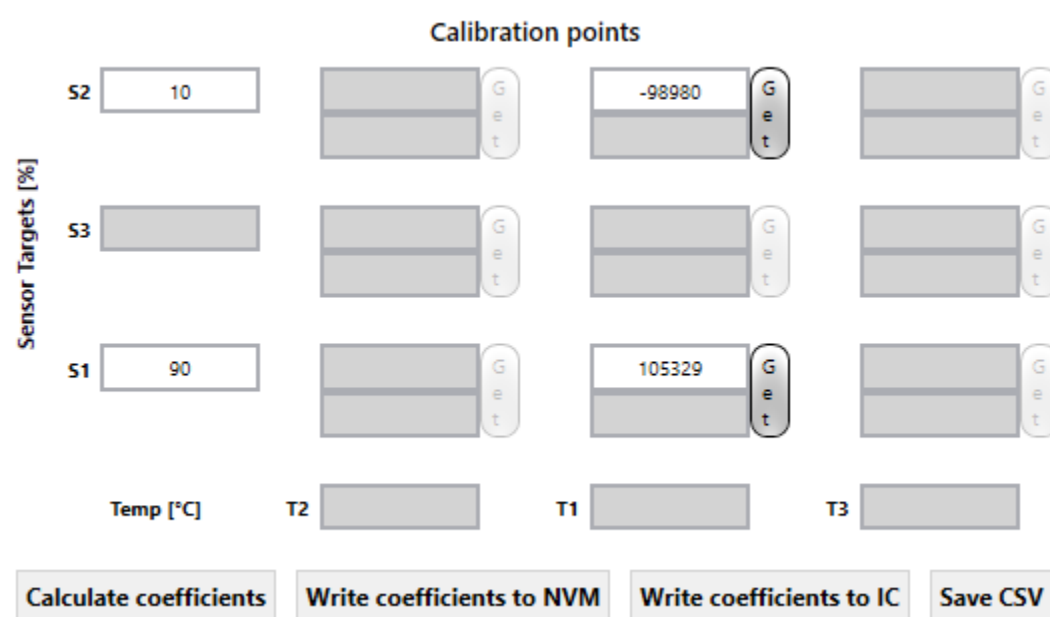

6. Verify that the “ADC Overflow” status indicator in the “IC STATUS” section is not on. If ADC overflow is on, go back to the configuration tab to adjust the AFE settings, see Figure 15. For more details on calibration types, refer to the *ZSSC3230 Data Sheet* and the *ZSSC3230_Calibration* document.

3.3 Coefficients Calculation

The coefficient calculation is done by the Dynamic Link Library (DLL) provided by Renesas. This DLL is accessible by any software and is provided to the customer as means for calibration on a large scale and integration with the customer’s existing workflow. Once the data is gathered and the user has clicked the “Calculate coefficients” button, the “SUCCESS” message is displayed in the “Coefficient result” table if a possible solution has been found, see Figure 24.

Figure 24. Coefficients Calculation

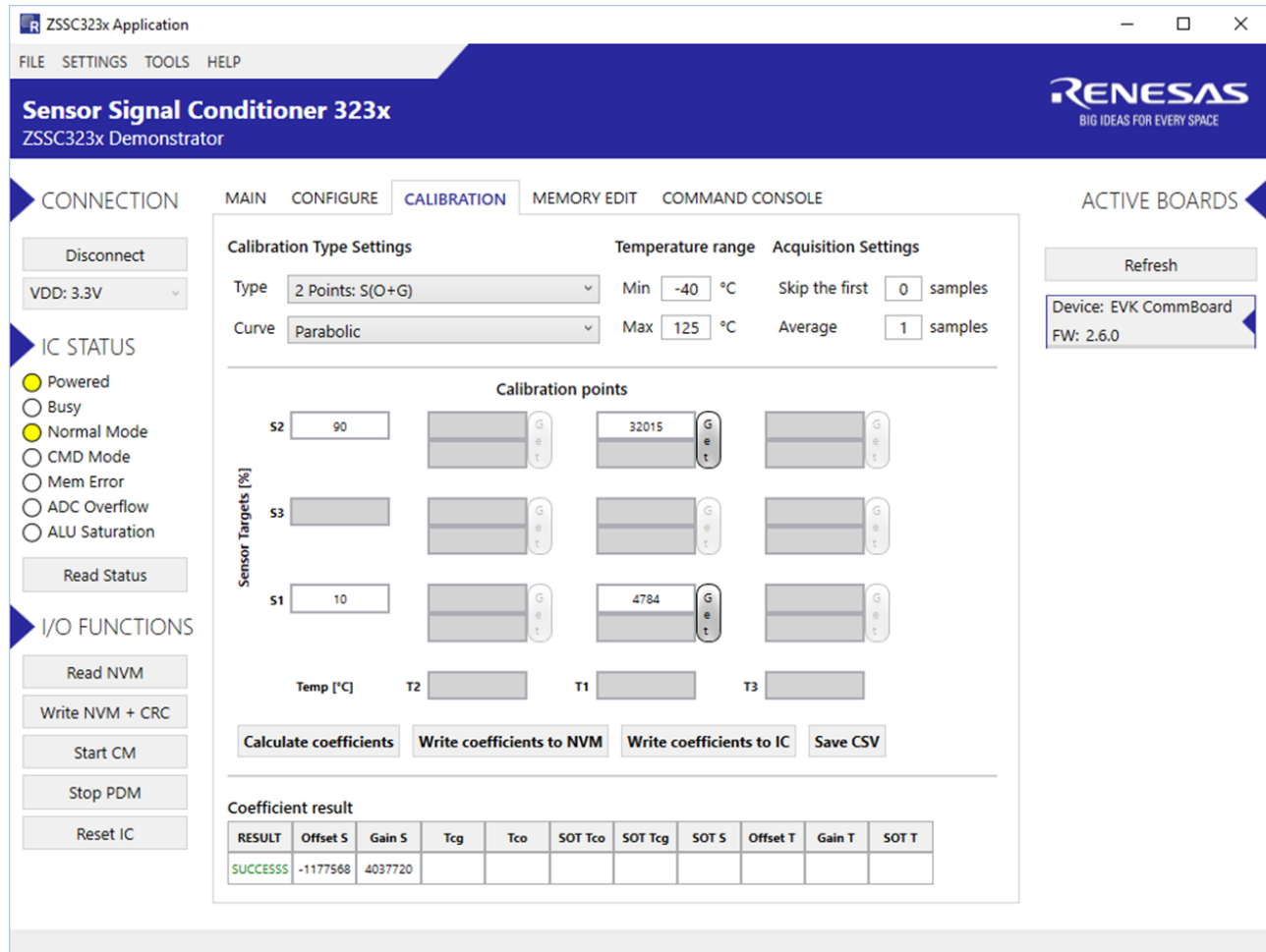

If the “FAILED” message is displayed, adjustments must be made to the AFE settings to achieve the optimal resolution without saturation of the calibration coefficients or ADC.

3.4 Memory Programming

The coefficients must be written to the IC memory when they are successfully calculated using the DLL. Writing to IC memory can use one of these methods:

- Click the “Write coefficients to IC” button.
- Click the “Write coefficients to NVM” button and then click the “Write NVM+ CRC” button on the “MEMORY EDIT” application tab.

Calibration coefficients can also be calculated without an EVK board connected and hence without getting read data. It is possible to input the raw value in the relevant fields shown in Figure 24. Then calculation of coefficients can be performed as already described, and coefficients can be saved using the button “Write coefficients to NVM”

The “Write coefficients to NVM” button differs from the “Write coefficients to IC” one, because it can be used just to update the memory map without writing the new coefficient values. In such case the memory map shows the new values in red (meaning the values are not yet written in the IC memory), see Figure 25. This allows to save the coefficients to a .CSV file without writing to the chip memory.

Figure 25. Coefficients in Memory Map

The screenshot shows the ZSSC323x Demonstrator software interface. On the left, there is a 'CONNECTION' section with a 'Disconnect' button and 'VDD: 3.3V'. Below it is an 'IC STATUS' section with several status indicators: Powered (checked), Busy, Normal Mode (checked), CMD Mode, Mem Error, ADC Overflow, and ALU Saturation. The main area is titled 'MEMORY EDIT' and contains a table of memory coefficients.

MTP	0	1	2	3	4	5	6	7
00h	0000	0000	0048	6F80	A693	0000	0000	0000
08h	0000	0000	0000	0000	0000	8523	0000	0000
10h	0000	0000	3E7F	0000	0000	0000	0000	0000
18h	0000	FA03	6AC2	A87B	F7E5			

Summary of the calibration steps is provided in Figure 26.

Figure 26. Steps on Calibration Tab

The screenshot shows the 'CAL' tab in the ZSSC323x Application. The interface is divided into several sections:

- Calibration Type Settings:** Includes 'Type' (2 Points: (O+G)), 'Parabolic', and 'Sensor Targets [%]' (S1: 10, S2: 90).
- Temperature range:** Includes 'Min' (-40 °C) and 'Max' (125 °C).
- Acquisition Settings:** Includes 'Skip the first' (0 samples) and 'Average' (1 samples).
- Calibration points:** A table with columns for 'Sensor Targets [%]' (S1, S2, S3) and 'Temp [°C]' (T1, T2, T3). It shows values for S1 (10), S2 (90), T1 (4784), and T2 (32015).
- Coefficient result:** A table with columns for 'RESULT', 'Offset S', 'Gain S', 'Tcg', 'Tco', 'SOT Tco', 'SOT Tcg', 'SOT S', 'Offset T', 'Gain T', and 'SOT T'. The 'RESULT' is 'SUCCESS'.

Numbered callouts indicate the following steps:

- Select calibration type
- Select temperature range
- Set values for sampling
- Set target limits S1 and S2
- Set acquisition temperatures
- Acquire data for the active calibration points
- Calculate coefficients
- Write calculated coefficients
- Reset the ZSSC3230

3.5 Verification

After a successful coefficient calculation and memory programming is performed, a recommended practice is to read the memory contents and verify in the "MAIN" application tab that correct data is read from the sensor.

Measurement data values should be between the target points set during calibration (10% and 90%) as shown in Figure 27.

Figure 27. Calibrated Sensor Measurement

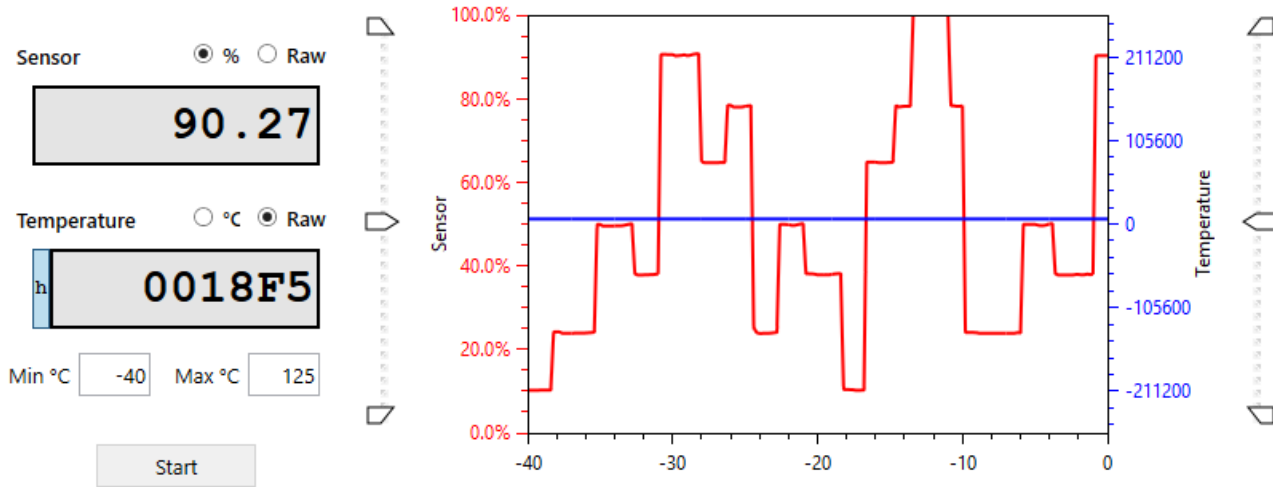

4. Schematics and Signal Connections between Boards

Figure 28. ZSSC3230 Evaluation Board Schematic

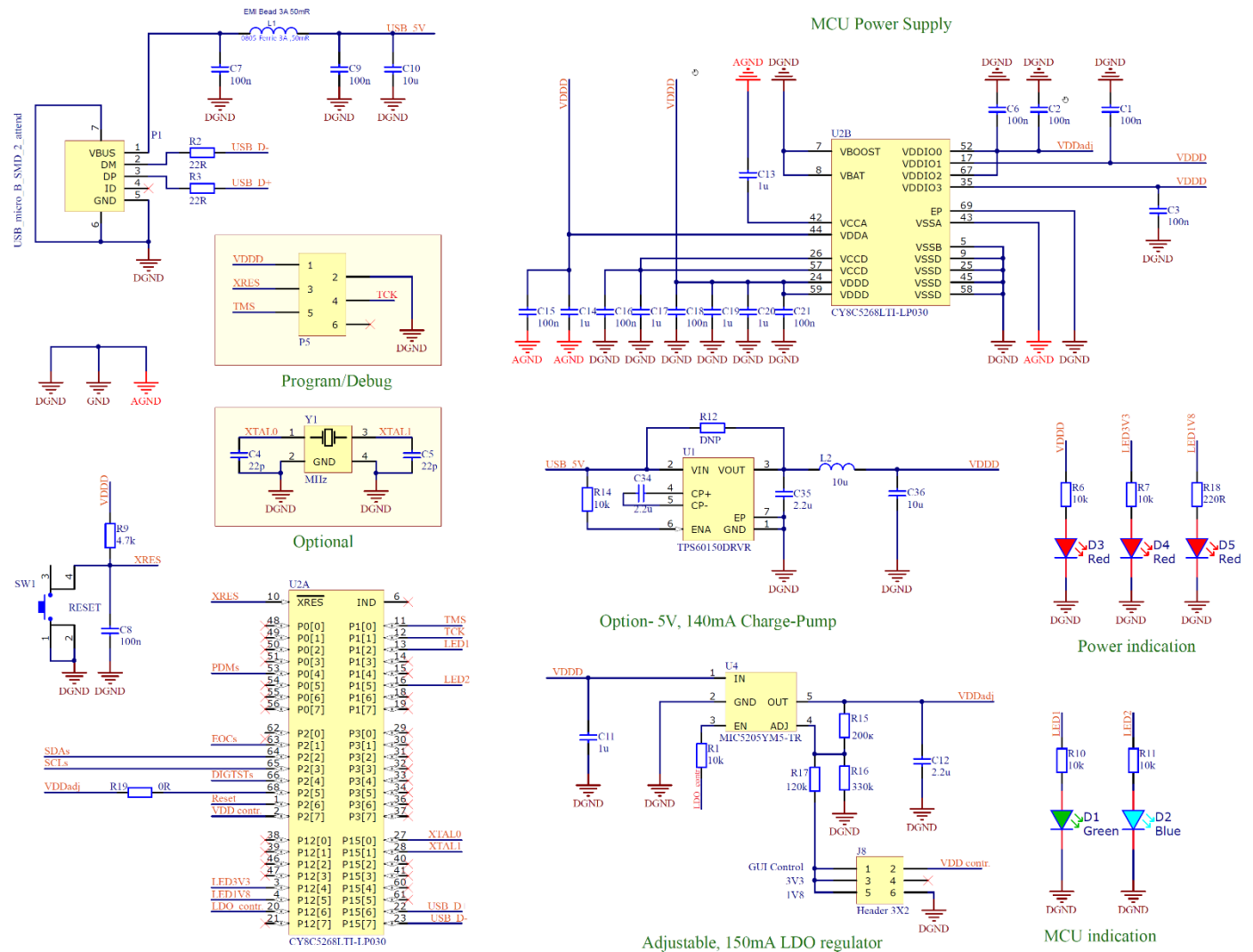

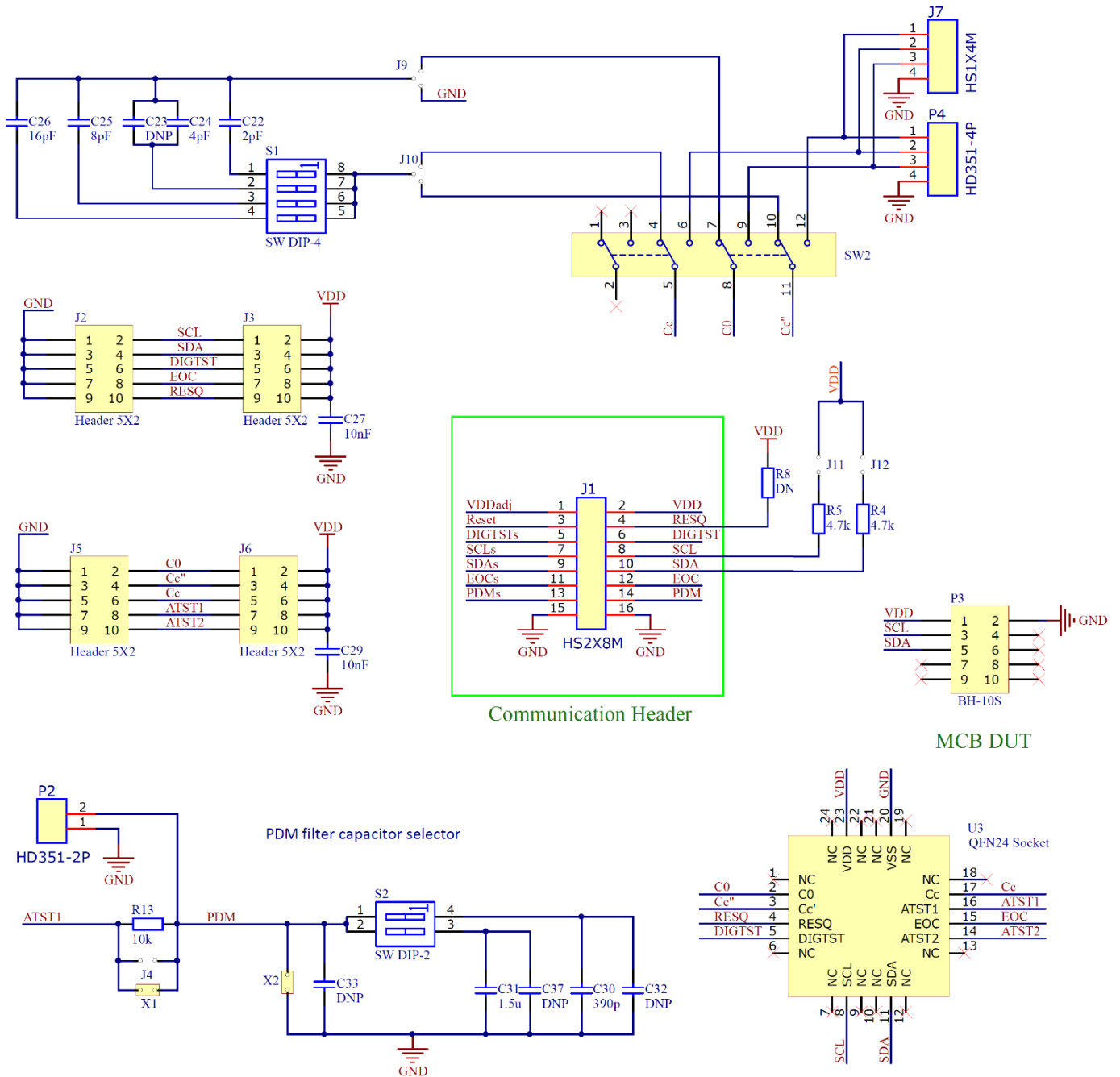

5. Bill of Materials (BOM)

Designator	Value/Part	Description	Footprint	Quantity
C1, C2, C3, C6, C7, C8, C9, C15, C16, C18, C21	C0603C104K5RACAUTO7411	C0603 100nF 50V X7R	0603	11
C4, C5		DNP		2
C10, C36	CL21A106KAYNNNE	10uF 25V X5R +-10%	0805	2
C11, C13, C14, C17, C19, C20		1.0uF 16V X7R +-10%	0603	6
C12, C34, C35	CL10A225KO8NNNC	2.2uF 16V X5R +-10%	0603	3
C22	CL10C020BB8NNNC	2.0pF 50V C0G +-0.25pF	0603	1
C23		DNP		1
C24	CBR06C409C5GAC	4pF C0G 0603 0.25pF	0603	1
C25	MC0603N8R0D500CT	8 pF, 50 V, 0603, ± 0.5pF, C0G	0603	1
C26	CL10C160JBNC	16pF 50V C0G +-5%	0603	1
C27, C29	CL10B103KB8NNNC	10nF 50V X7R +-10%	0603	2
C30	CL10C391JB8NNNC	390pF 50V COG +-5%	0603	1
C31	885012207023	Multilayer Ceramic Capacitor, 1.5 µF, 10 V, 0805, ± 10%, X7R	0805	1
C32, C33		DNP		2
C37		DNP'		1
D1	KP-2012SGC	2.0x1.25mm, 3.2-15mcd@20mA, 568nm Green, W.Clear, 120°	0805	1
D2	OSB50805C1E	2.0x1.25mm 80mcd/20mA 465nm Blue 120°	0805	1
D3, D4, D5	OSR50805C1E	2.0x1.25mm 150mcd/20mA 625nm Red 120°	0805	3
J1	CH81802V200	Board to Board/Wire Header, contact height 6.0mm, 2x40, straight PCB TH, P2.54mm	HN2X8	1
J2, J3, J5, J6	CH81802V200'	'Board to Board/Wire Header, contact height 6.0mm, 2x40, straight PCB TH, P2.54mm	HN2X5	4
J4, J11, J12	CH31022V200	Board to Board/Wire Header, contact height 6.0mm, 1x2, straight PCB TH, P2.54mm		3
J7	CH31042V200	Board to Board/Wire Header, contact height 6.0mm, 1x4, straight PCB TH, P2.54mm		1
J8	CH81802V200	Board to Board/Wire Header, contact height 6.0mm, 2x40, straight PCB TH, P2.54mm	HN2X3	1
J9, J10	CH31032V200	Board to Board/Wire Header, contact height 6.0mm, 1x3, straight PCB TH, P2.54mm		2
L1	BLM21PG300SN1D	Ferrite Bead, 0805, 30 ohm, 3 A, BLM21P Series, 0.014 ohm	0805	1

Designator	Value/Part	Description	Footprint	Quantity
L2	MLZ2012M100WT	Surface Mount High Frequency Inductor, MLZ Series, 10 μ H, 350 mA, 0805], Multilayer	0805	1
P1	ZX62D-B-5PA8(30)	Micro USB Type B, USB 2.0, Receptacle, 5 Ways, Surface Mount, Through Hole Mount		1
P2	HD-351 2P	10A 300V AC AWG24-18 3.5mm		1
P3		DNP		1
P4	HD-351 2P	10A 300V AC AWG24-18 3.5mm		2
P5		DNP		1
R1, R6, R7, R10, R13, R14, R11	0603SAF0103T50	RES SMD 0603 1% 100ppm 10K 1/10W	0603	7
R2, R3	0603SAF0220T50	RES SMD 0603 1% 200ppm 22R 1/10W	0603	2
R4, R5, R9	0603SAF0472T50	RES SMD 0603 1% 100ppm 4.7K 1/10W	0603	3
R8, R12		DNP	0603	2
R15	0603SAF0204T50	RES SMD 0603 1% 100ppm 200K 1/10W	0603	1
R16	0603SAF0334T50	RES SMD 0603 1% 100ppm 1330K 1/10W	0603	1
R17	0603SAF0124T50	RES SMD 0603 1% 100ppm 200K 1/10W	0603	1
R19	0603SAJ000JT50	RES SMD 0603 JUMPER MAX 50mOhm	0603	1
R18	0603SAF0221T50	RES SMD 0603 1% 100ppm 220R 1/10W	0603	1
S1	DM-04-V	DIP switch 4p SPST ON-OFF SMD		1
S2	DM-02-V	RS02 SMD		1
SW1	B3FS-1000P	Tact Switch 2p SPST-NO. 50mA/24V 6x6x3.1mm 100gf		1
SW2	MMS42	Slide Switches Micromini slide rt angle actutr 4P2T		1
U1	TPS60150DRVR	DC/DC Inductorless Converter, Fixed, Boost (Step Up), 2.7 V to 5.5 V in, 3.3 V/140 mA out, SON-6	WSON 6	1
U2	CY8C5268LTI-LP030	ARM Microcontroller, PSOC 5LP, PSOC 5 Family CY8C52xx Series Microcontrollers, ARM Cortex-M3, 32bit	QFN68	1
U3	24LQ50K14040-E	ZIF Socket QFN24	ZIF-QFN24	1
U4	MIC5205YM5-TR	150mA uCap LDO w/Flag	SOT-23-5	1
X1	CB39022V100	Board to Board Socket, body height 8.5mm, 1x2, straight PCB TH, P2.54mm		1
X2	CB39022V100	Board to Board Socket, body height 8.5mm, 1x2, straight PCB TH, P2.54mm		1
Y1	C0603C104K5RACAUTO7411	DNP		1

6. Board Layout

Figure 29. ZSSC3230 Evaluation Board – Layout

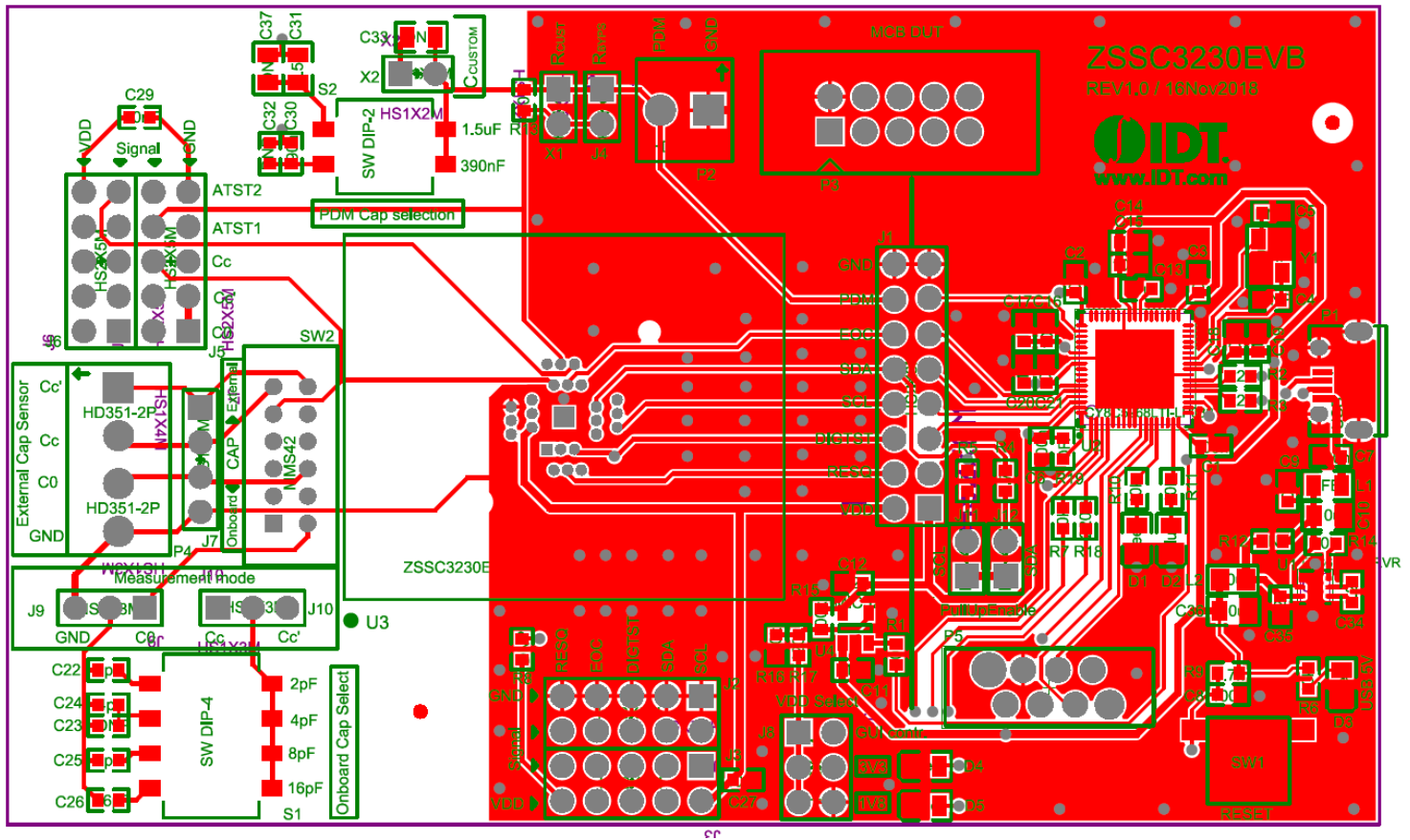

7. Related Documents and Software

Visit the following product pages on Renesas' website <https://www.renesas.com> to download the latest version of the ZSSC3230 Evaluation Software, related documents, and the latest version of this document, or contact Renesas via the contact information on the last page.

- Product page: <https://www.renesas.com/us/en/products/sensor-products/sensor-signal-conditioners/zssc3230-low-power-high-resolution-capacitive-sensor-signal-conditioner>
- Kit product page: <https://www.renesas.com/us/en/products/sensor-products/sensor-signal-conditioners-ssc-afe/zssc3230kit-evaluation-kit-zssc3230>

8. Glossary

Term	Definition
ADC	Analog-to-Digital Converter
AFE	Analog Front End
ALU	Arithmetic Logic Unit
CMD Mode	Command Mode
CRC	Cyclic Redundancy Check
DEC	Decimal
DIP	Dual In-line Package
DLL	Dynamic Link Library
DNP	Do Not Populate
DUT	Device Under Test
EEPROM	Electrically Erasable Programmable Read-Only Memory
EVB	Evaluation Board
GUI	Graphical User Interface – refers to the application used for communication with the kit
HEX	Hexadecimal
I2C	Inter-Integrated Circuit
IC	Integrated Circuit
LDO	Low-Dropout Regulator
LED	Light Emitting Diode
MCU	Microcontroller Unit
NOM	Normal Mode
NVM	Non-Volatile Memory
PCB	Printed Circuit Board
PDM	Pulse Density Modulation
(P)QFN	(Power) Quad Flat No-lead
SMD	Surface-Mounted Device
SOT	Second Order Term
SSC	Sensor Signal Conditioner
TH	Trough-Hole
USB	Universal Serial Bus
ZIF	Zero Insertion Force

9. Ordering Information

Orderable Part Number	Description
ZSSC3230KIT	ZSSC3230 EVALUATION KIT

10. Revision History

Revision Date	Description of Change
September 4, 2019	Initial version.
June 8, 2021	Template update for Renesas, minor changes in GUI parameters descriptions