

Coaxial Amplifier

ZX60-2510MA+

50Ω High Isolation 500 to 2500 MHz

Features

- from 2.8V to 5V operation
- wide bandwidth, 500 to 2500 MHz
- high active directivity
- output power, 18 dBm typ. at 2 GHz and 5V
- protected by US patent 6,790,049

Applications

- buffer amplifier
- LO amplifiers for mixers
- cellular
- PCN



CASE STYLE: GC957

Connectors	Model
SMA	ZX60-2510MA-S+

+RoHS Compliant

The +Suffix identifies RoHS Compliance. See our web site for RoHS Compliance methodologies and qualifications

Electrical Specifications at 25°C

Parameter	Condition (MHz)	2.8V			5.0V			Units
		Min.	Typ.	Max.	Min.	Typ.	Max.	
Frequency		500		2500	500		2500	MHz
Gain	500	—	12.6	—	—	14.3	—	dB
	1000	—	13.1	—	—	15	—	
	1500	—	13.1	—	—	15.2	—	
	2000	—	12.8	—	13.5	15	—	
	2500	—	12.2	—	—	14.6	—	
Output Power at 1dB compression	500	—	11.0	—	—	20.0	—	dBm
	2500	—	12.0	—	—	18.0	—	
Noise Figure	1000	—	5.4	—	—	5.3	—	dB
Output third order intercept point	1000	—	24.0	—	—	32.0	—	dBm
	2000	—	24.0	—	—	31.0	—	
Input VSWR	1100-2500	—	1.4	—	—	1.4	—	:1
Output VSWR	1100-2500	—	1.4	—	—	1.4	—	:1
Active Directivity (Isolation-Gain)	500	—	36	—	—	32	—	dB
	2500	—	20	—	—	19	—	
Supply Current		—	79	—	—	84	104	mA

Outline Drawing

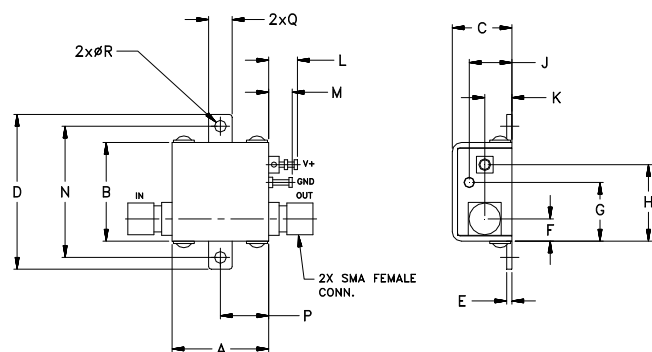

NOTE: When soldering the DC connections, caution must be used to avoid overheating the DC terminal. See Application Note, AN-40-010.

Outline Dimensions (inch/mm)

A	B	C	D	E	F	G	H	J	K	L	M	N	P	Q	R	wt
.74	.75	.46	1.18	.04	.17	.45	.59	.33	.21	.22	.18	1.00	.37	.18	.106	grams
18.80	19.05	11.68	29.97	1.02	4.32	11.43	14.99	8.38	5.33	5.59	4.57	25.40	9.40	4.57	2.69	23.0

Notes

- Performance and quality attributes and conditions not expressly stated in this specification document are intended to be excluded and do not form a part of this specification document.
- Electrical specifications and performance data contained in this specification document are based on Mini-Circuit's applicable established test performance criteria and measurement instructions.
- The parts covered by this specification document are subject to Mini-Circuits standard limited warranty and terms and conditions (collectively, "Standard Terms"); Purchasers of this part are entitled to the rights and benefits contained therein. For a full statement of the Standard Terms and the exclusive rights and remedies thereunder, please visit Mini-Circuits' website at www.minicircuits.com/MCLStore/terms.jsp



www.minicircuits.com P.O. Box 350166, Brooklyn, NY 11235-0003 (718) 934-4500 sales@minicircuits.com

Maximum Ratings

Parameter	Ratings
Operating Temperature	-40°C to 85°C Case
Storage Temperature	-55°C to 100°C
DC Voltage	7V
Input RF Power (no damage)	+11 dBm at VS=2.8V and +16 dBm at 5V (continuous operation) +23 dBm (5 minutes max.)
Power Dissipation	800 mW

Permanent damage may occur if any of these limits are exceeded.

FREQUENCY (MHz)	GAIN (dB)		DIRECTIVITY (dB)		VSWR IN (:1)		VSWR OUT (:1)		POUT at 1 dB COMPR. (dBm)		NOISE FIGURE (dB)	
	2.8V	5V	2.8V	5V	2.8V	5V	2.8V	5V	2.8V	5V	2.8V	5V
500	12.61	14.20	37.54	34.62	2.26	2.34	1.55	1.48	11.69	20.05	5.75	5.64
600	12.86	14.53	36.24	35.47	1.86	1.91	1.40	1.29	12.28	20.26	5.65	5.52
700	12.99	14.72	34.17	35.25	1.64	1.68	1.32	1.19	12.33	20.24	5.59	5.45
800	13.07	14.85	31.60	33.31	1.49	1.53	1.28	1.15	12.66	20.24	5.46	5.42
900	13.11	14.94	30.27	31.38	1.40	1.44	1.26	1.14	12.47	20.01	5.46	5.35
1000	13.14	15.00	29.02	29.82	1.33	1.37	1.25	1.15	12.68	20.12	5.43	5.36
1100	13.15	15.06	27.69	28.47	1.28	1.32	1.25	1.16	12.89	20.04	5.46	5.34
1300	13.15	15.13	26.11	26.29	1.22	1.28	1.25	1.19	12.89	20.00	5.56	5.39
1500	13.10	15.16	24.69	24.72	1.19	1.26	1.26	1.23	12.90	19.82	5.44	5.33
1600	13.06	15.16	24.35	24.14	1.18	1.26	1.27	1.25	12.92	19.62	5.44	5.29
1800	12.96	15.13	23.32	23.14	1.18	1.26	1.28	1.29	13.09	19.33	5.47	5.34
2000	12.84	15.07	22.55	22.41	1.18	1.27	1.30	1.33	12.94	19.14	5.44	5.30
2200	12.67	14.95	22.04	21.76	1.18	1.27	1.31	1.37	12.99	18.70	5.43	5.28
2400	12.46	14.77	21.68	21.18	1.18	1.27	1.33	1.41	12.77	18.57	5.42	5.30
2500	12.35	14.67	21.42	21.17	1.19	1.27	1.33	1.43	13.00	18.53	5.49	5.34

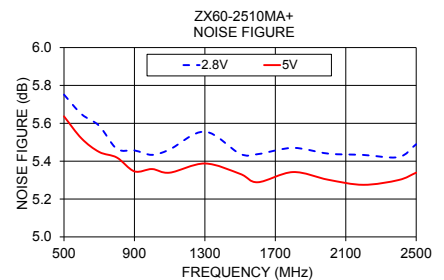
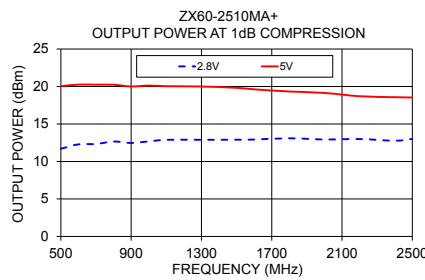
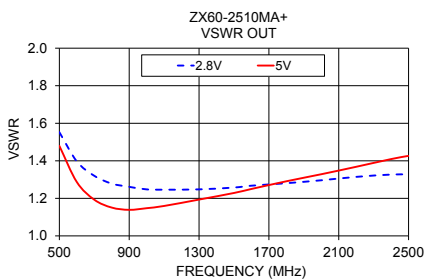
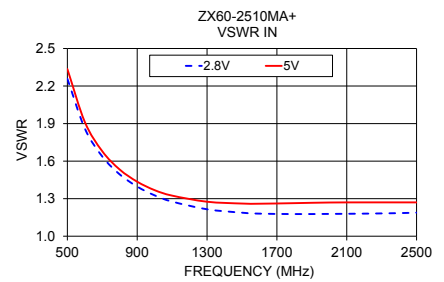
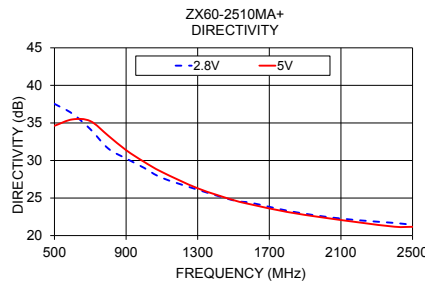
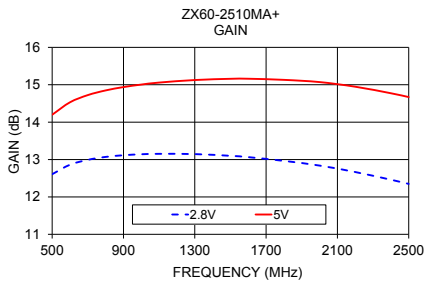

Notes

- A. Performance and quality attributes and conditions not expressly stated in this specification document are intended to be excluded and do not form a part of this specification document.
- B. Electrical specifications and performance data contained in this specification document are based on Mini-Circuit's applicable established test performance criteria and measurement instructions.
- C. The parts covered by this specification document are subject to Mini-Circuits standard limited warranty and terms and conditions (collectively, "Standard Terms"); Purchasers of this part are entitled to the rights and benefits contained therein. For a full statement of the Standard Terms and the exclusive rights and remedies thereunder, please visit Mini-Circuits' website at www.minicircuits.com/MCLStore/terms.jsp

