

# Coaxial Amplifier

# ZX60-5916MA+

50Ω High Isolation 1.5 to 6 GHz

## Features

- from 2.8V to 5V operation
- wide bandwidth, 1.5 to 6 GHz
- high active directivity
- output power, up to 17dBm typ.
- protected by US patent 6,790,049

## Applications

- buffer amplifier
- LO amplifiers for mixers
- cellular
- PCN



CASE STYLE: GC957

Connectors	Model
SMA	ZX60-5916MA-S+

### +RoHS Compliant

The +Suffix identifies RoHS Compliance. See our web site for RoHS Compliance methodologies and qualifications

## Electrical Specifications T<sub>AMB</sub>=25°C

MODEL NO.	FREQ. (GHz)		DC VOLTS (V)	GAIN, dB Typical					MAXIMUM POWER (dBm)		DYNAMIC RANGE			VSWR* (:1) Typ.		ACTIVE DIRECTIVITY (dB) (Isolation-Gain) Typ.		DC OPERATING CURRENT @ Pin V+ (mA)		
	f <sub>L</sub>	f <sub>U</sub>		over frequency, GHz					Output (1 dB Comp.) Typ.		NF (dB) Typ.	IP3 (dBm) Typ.		In	Out	f <sub>L</sub>	f <sub>U</sub>	Typ	Max.	
				1.5	2.0	3.5	5.0	6.0	f <sub>L</sub>	f <sub>U</sub>		at 2 GHz	at 2 GHz							at 6.0 GHz
ZX60-5916MA+	1.5	6.0	5.0	17.3	17.3	17.3	18.4	12.0	15	16.5	13	6.6	27	23.5	1.6	1.3	37	25	74	103
			2.8	14	14.2	14.2	16.2	7.0	—	10	16	5.8	22	16	1.6	1.7	37	27	70	—

\* at 3 GHz - 5 GHz

## Maximum Ratings

Operating Temperature	-40°C to 85°C case
Storage Temperature	-55°C to 100°C
DC Voltage	7V
Input Power (No damage)	10 dBm (continuous operation) 26 dBm over 1.5 to 3.7 GHz (5 minutes max.) 20 dBm over 3.7 to 6 GHz (5 minutes max.)
Power Dissipation	750 mW

Permanent damage may occur if any of these limits are exceeded.

## Outline Drawing

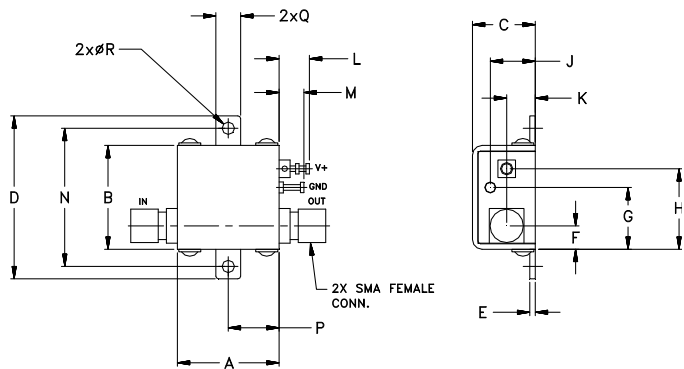

**NOTE:** When soldering the DC connections, caution must be used to avoid overheating the DC terminal. See Application Note. [AN-40-010](#).

## Outline Dimensions (inch/mm)

A	B	C	D	E	F	G	H	J	K	L	M	N	P	Q	R	wt
.74	.75	.46	1.18	.04	.17	.45	.59	.33	.21	.22	.18	1.00	.37	.18	.106	grams
18.80	19.05	11.68	29.97	1.02	4.32	11.43	14.99	8.38	5.33	5.59	4.57	25.40	9.40	4.57	2.69	23.0

## Notes

- Performance and quality attributes and conditions not expressly stated in this specification document are intended to be excluded and do not form a part of this specification document.
- Electrical specifications and performance data contained in this specification document are based on Mini-Circuit's applicable established test performance criteria and measurement instructions.
- The parts covered by this specification document are subject to Mini-Circuits standard limited warranty and terms and conditions (collectively, "Standard Terms"); Purchasers of this part are entitled to the rights and benefits contained therein. For a full statement of the Standard Terms and the exclusive rights and remedies thereunder, please visit Mini-Circuits' website at [www.minicircuits.com/MCLStore/terms.jsp](http://www.minicircuits.com/MCLStore/terms.jsp)



[www.minicircuits.com](http://www.minicircuits.com) P.O. Box 350166, Brooklyn, NY 11235-0003 (718) 934-4500 sales@minicircuits.com

FREQUENCY (MHz)	GAIN (dB)		DIRECTIVITY (dB)		VSWR IN (:1)		VSWR OUT (:1)		POUT at 1 dB COMPR. (dBm)		NOISE FIGURE (dB)	
	2.8V	5V	2.8V	5V	2.8V	5V	2.8V	5V	2.8V	5V	2.8V	5V
1500	14.34	17.57	38.68	38.57	2.30	2.27	1.13	1.01	10.45	16.32	7.34	6.66
1700	14.53	17.67	34.82	33.21	2.05	1.98	1.19	1.03	10.62	16.22	6.89	6.21
2000	14.55	17.53	31.29	29.92	1.82	1.72	1.28	1.08	10.69	15.80	6.41	5.68
2300	14.44	17.33	28.97	27.44	1.69	1.57	1.37	1.12	10.63	15.25	6.06	5.32
2600	14.32	17.21	27.45	26.09	1.59	1.47	1.43	1.17	10.36	14.68	5.83	5.06
2900	14.27	17.21	26.03	24.57	1.51	1.39	1.49	1.22	10.28	13.85	5.51	4.79
3200	14.29	17.34	24.95	23.34	1.44	1.32	1.52	1.27	9.89	13.29	5.27	4.56
3500	14.44	17.58	24.05	22.10	1.36	1.25	1.54	1.30	9.54	12.71	5.06	4.37
3800	14.75	17.93	23.38	21.28	1.27	1.20	1.54	1.31	9.47	12.48	4.81	4.21
4100	15.27	18.35	23.13	21.03	1.18	1.13	1.52	1.27	9.46	12.27	4.59	4.08
4400	15.86	18.67	22.14	20.76	1.09	1.06	1.44	1.18	9.70	12.42	4.32	3.89
4700	16.41	18.75	20.47	20.35	1.13	1.06	1.31	1.07	10.66	13.33	4.24	3.88
5000	16.51	18.52	19.10	19.53	1.31	1.17	1.18	1.13	11.97	14.50	4.06	3.76
5400	14.45	17.32	20.89	20.07	1.62	1.39	1.32	1.32	11.80	15.71	4.28	3.92
6000	7.57	12.56	28.82	24.93	1.81	1.66	1.67	1.50	6.49	12.80	5.80	4.80

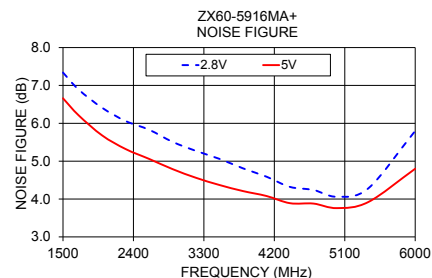
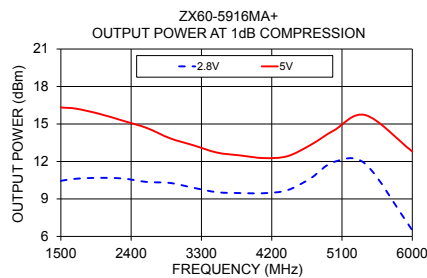
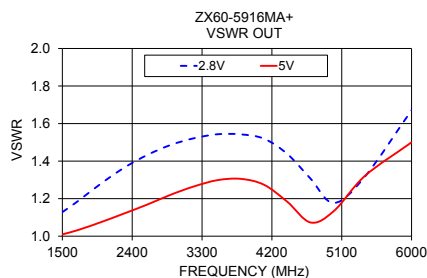
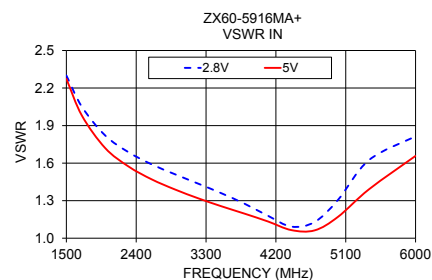
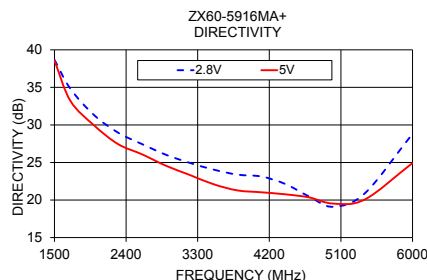
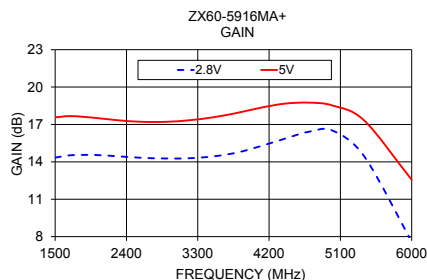

**Notes**

- A. Performance and quality attributes and conditions not expressly stated in this specification document are intended to be excluded and do not form a part of this specification document.
- B. Electrical specifications and performance data contained in this specification document are based on Mini-Circuit's applicable established test performance criteria and measurement instructions.
- C. The parts covered by this specification document are subject to Mini-Circuits standard limited warranty and terms and conditions (collectively, "Standard Terms"); Purchasers of this part are entitled to the rights and benefits contained therein. For a full statement of the Standard Terms and the exclusive rights and remedies thereunder, please visit Mini-Circuits' website at [www.minicircuits.com/MCLStore/terms.jsp](http://www.minicircuits.com/MCLStore/terms.jsp)

