

gen4-FT81x Series



gen4-FT812-43T (4.3" Resistive touch)

gen4-FT812-50T (5.0" Resistive touch)

gen4-FT812-70T (7.0" Resistive touch)

gen4-FT813-43CT (4.3" Capacitive touch)

gen4-FT813-43CT-CLB (4.3" Capacitive touch with Cover Lens Bezel)

gen4-FT813-50CT-CLB (5.0" Capacitive touch with Cover Lens Bezel)

gen4-FT813-70CT-CLB (7.0" Capacitive touch with Cover Lens Bezel)

Datasheet

Contents

1. Description	3
2. Features	4
3. Pin Configuration	5
4. Hardware Interface - Pins	7
4.1. Pin Detail	7
4.2. Connection Detail	9
5. Audio Filter and Amplifier Reference Circuit	10
6. Display Module Numbers	11
7. Cover Lens Bezel - Tape Spec	11
8. FFC Cable	12
9. Mechanical Details 4.3" (Resistive Touch without Cover Lens Bezel)	13
10. Mechanical Details 5.0" (Resistive Touch without Cover Lens Bezel)	14
11. Mechanical Details 7.0" (Resistive Touch without Cover Lens Bezel)	15
12. Mechanical Details 4.3" (Capacitive Touch without Cover Lens Bezel)	16
13. Mechanical Details 4.3" (Capacitive Touch with Cover Lens Bezel)	17
14. Mechanical Details 5.0" (Capacitive Touch with Cover Lens Bezel)	18
15. Mechanical Details 7.0" (Capacitive Touch with Cover Lens Bezel)	19
16. Schematic Details (HW REV 1.3)	20
17. Specifications	21
18. LCD Timing Details	26
19. LCD Timing Characteristic	28
20. Revision History	32

1. Description

The gen4-FT812/gen4-FT813 display is an embedded SPI display from 4D Systems. It features a Resistive Touch panel or Capacitive Touch panel display with an integrated FTDI FT81x Video Engine. The FT812 is for Resistive Touch models, and the FT813 is for Capacitive Touch models.

It is a powerful SPI Display that enables a SPI host to be connected directly to the display, providing a powerful set of graphics features to the host using the onboard FTDI FT81x Video Engine.

This display provides 4-in-one functionality, a TFT LCD Display (4.3"/5.0"/7.0), Audio with an amplifier enable, a Resistive/Capacitive Touch screen, and an integrated Video Engine. This combination built directly into the screen allows for simple integration into a number of applications.

The FT81x Video Engine runs the FTDI version of EVE (Embedded Video Engine), which targets high-quality graphics displays with Widget support, designed to offload the Host Processor and provide a variety of graphics features.

Note

These display modules are not compatible with 4D Systems Workshop4 IDE.

All software support for the FT812/FT813 is provided directly from FTDI. Hardware support is provided by 4D Systems.

For the FT81X Embedded Video Engine Datasheet, you may follow this link:

- https://brtchip.com/wp-content/uploads/Support/Documentation/Datasheets/ICs/EVE/DS_FT81x.pdf

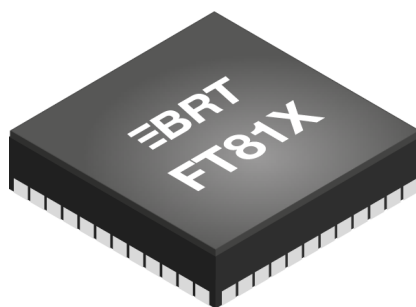

2. Features

- 480x272 Resolution (4.3")
 - 800x480 Resolution (5.0" & 7.0")
 - TFT Screen with an integrated 4-wire Resistive Touch Panel (T), or Capacitive Touch Panel (CT) with Cover Lens Bezel (CLB).
 - Mono PWM Audio output with a separate amplifier enable, designed to be connected directly to a simple filter and external amplifier circuit.
 - On board FTDI FT81x Video Engine.
 - SPI Interface to Host Processor/Controller, up to 30Mhz (Mode 0 only).
 - Programmable Interrupt Controller, with dedicated Interrupt pin to Host.
 - 64-voice polyphonic sound synthesizer.
 - PWM dimming control for LCD backlight
 - Power mode control to put the FT812/FT813 into sleep and standby modes, with the dedicated power-down pin to Host.
 - JPEG and motion-JPEG decode
 - Single 5.0V supply
 - 3.3V SPI Bus, Audio Output and amplifier Enabled, along with GPIO (not 5V tolerant).
 - 4 x 4.0mm Mounting holes on Resistive Touch modules. 3M Adhesive for Capacitive Touch modules on the rear of the CLB (Cover Lens Bezel) periphery.
 - RoHS and CE compliant.
-
- | | |
|--|--|
| <ul style="list-style-type: none"> • Module dimensions: • (4.3" T) 127.6 x 69.3 x 7.9 mm • (5.0" T) 142.8 x 77.9 x 7.8 mm • (7.0" T) 187 x 102.1 x 7.8 mm • (4.3" CT) 127.6 x 69.3 x 8.1 mm • (4.3" CT-CLB) 123 x 84.5 x 8.4 mm • (5.0" CT/CLB) 140.7 x 93.8 x 8.3 mm • (7.0" CT/CLB) 190.1 x 121.9 x 9 mm | <ul style="list-style-type: none"> • Touch Area: • 4.3" - 95.04 x 53.86mm • 5.0" - 108 x 64.80 mm • 7.0" - 153.84mm x 85.63 mm |
|--|--|

3. Pin Configuration



gen4-FT81x 30-way FFC interface

Pin	Symbol	I/O	Description
1	GND	P	Power Ground
2	SPL_PD	I	Power Down Input from Host
3	SPL_INT	O	Configurable Interrupt to Host
4	SPL_CS	I	SPI Chip Select from Host
5	GND	P	Power Ground
6	SPL_MOSI	I	SPI Data Input from Host
7	SPL_MISO	O	SPI Data Output to Host
8	SPL_SCK	I	SPI Clock Input from Host
9	GND	P	Power Ground
10	AUD_PWM	O	Audio Output PWM, requires simple filter and then to Amplifier
11	GND	P	Power Ground
12	AUD_PD	O	Audio Shutdown Output to Amplifier
13	GND	P	Power Ground
14	GPIO0	I/O	General Purpose IO pin
15	GPIO2	I/O	General Purpose IO pin
16	GPIO3	I/O	General Purpose IO pin
17	GND	P	Power Ground
18	-	-	Not Connected
19	-	-	Not Connected
20	-	-	Not Connected
21	GND	P	Power Ground

Pin	Symbol	I/O	Description
22	-	-	Not Connected
23	-	-	Not Connected
24	GND	P	Power Ground
25	GND	P	Power Ground
26	+5V	P	+5V Supply Pin
27	+5V	P	+5V Supply Pin
28	-	-	Not Connected
29	-	-	Not Connected
30	GND		Power Ground

 **Note**

I = Input, **O** = Output, **P** = Power

4. Hardware Interface - Pins

The gen4-FT81x Display uses a 30-way pin FFC which you can breakout to communicate with a microcontroller.

4.1. Pin Detail

Pin 1,5,9,11,13,17,21,24,25,30: GND - Power Ground:

This is the Power Ground for the gen4-FT81x Display. This should be connected to the GND associated with the Pin 26/27 5V Power Input pin.

Pin 2: SPI_PD - Power Down Input:

This is the Power Down Input for the Display, which can be triggered by the Host Processor if the display is required to be powered down, either from a standby state or from its active state.

This is pulled high to 3.3V by the display module and is Active Low.

Holding this pin low for >5mS will cause the FT81x Video Engine to shut down and go into a powered-down state. Releasing this low or driving the pin High will cause the display to start up again.

It is also possible to reset the display using this pin, by driving it low for 5mS and then high again.

Pin 3: SPI_INT - Configurable Interrupt Output:

This is the Configurable Interrupt Output from the display, which can be configured to be triggered by many events and is used to interrupt the Host Processor when the interrupt event occurs. This is an Open Drain output, which is pulled high to 3.3V by the display module and is Active Low.

Pin 4: SPI_CS - SPI Chip Select Input:

This is the SPI Chip Select Input for the Display, which comes from the Host processor. This is 3.3V logic and is not 5V tolerant, please only connect 3.3V compatible devices to this pin.

Pin 6: SPI_MOSI - SPI Data Input:

This is the SPI Data Input for the Display, which comes from the Host processor. This is 3.3V logic and is not 5V tolerant, please only connect 3.3V compatible devices to this pin.

Pin 7: SPI_MISO - SPI Data Output:

This is the SPI Data Output from the Display, which goes to the Host processor. This is 3.3V logic and is not 5V tolerant, please only connect 3.3V compatible devices to this pin.

Pin 8: SPI_SCK - SPI Clock:

This is the Clock Input for the SPI Bus which comes from the host. This is 3.3V logic and is not 5V tolerant, please only connect 3.3V compatible devices to this pin. The FT812/FT813 can run up to a maximum of 30Mhz on the SPI Bus.

Pin 10: AUDIO_PWM - Audio Output:

This is the Audio Output from the FT81x Video Engine, which is a Push/Pull PWM Output capable of Source/Sink of 16mA of current.

This pin is designed to be passed into a simple filter circuit and then passed to an amplifier for best results.

 **Note**

The gen4-FT81x display module does not have a built-in amplifier. It needs to be connected to an external amplifier to utilize the sound functionality.

Please refer to the example schematic in the [Audio Filter and Amplifier Reference Circuit](#) section which provides the recommended circuit to connect to this pin.

Pin 12: AUDIO_PD - Audio Shutdown:

This is the Audio Shutdown output from the FT81x Video Engine, which is designed to enable/disable an external audio amplifier based on the events occurring on the FT812/FT813.

This pin is the GPIO01 General Purpose I/O on the FT812/FT813, so could be used for an alternative function if required.

Pin 14: GPIO0 - General Purpose Pin**Pin 15: GPIO2 - General Purpose Pin****Pin 16: GPIO3 - General Purpose Pin****Pin 26,27: 5V - Power Input:**

Module supply voltage input pins This pin should be connected to a stable supply voltage in the range of 4.5 Volts to 5.5 Volts DC. The nominal operating voltage is 5.0 Volts. A 5V to 3.3V regulator is connected to the FT81x Video chip.

4.2. Connection Detail

The gen4-FT81x Display module features a 30-way flexible FPC, which is designed to connect to a custom board that maps the signal according to the pin configuration specified above.

The user can also use the breakout board that the 4D Systems has made and connect it to their Host Processor / MCU.

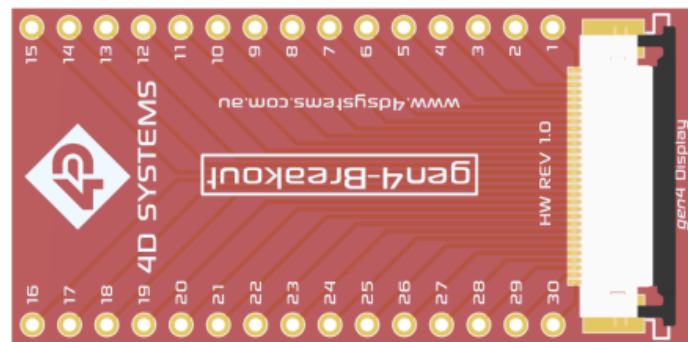

The gen4-FT81x Display module with a breakout board connects to a target Host Processor / MCU using a 3.3V SPI Bus and also features an Interrupt Pin and Shutdown Pin for applications that can make use of them.

The Display can generate PWM audio, both Mono PCM and Polyphonic MIDI, which exits the display module via the 30-way FPC and should then be fed into a simple filter and amplifier circuit. This circuit is shown in the [Audio Filter and Amplifier Reference Circuit](#) section and should be treated as the recommended circuit, however, alternative circuits are also possible.

Please refer to the FTDI FT81x Datasheet and website for more specific information on how to utilize these features.

5. Audio Filter and Amplifier Reference Circuit

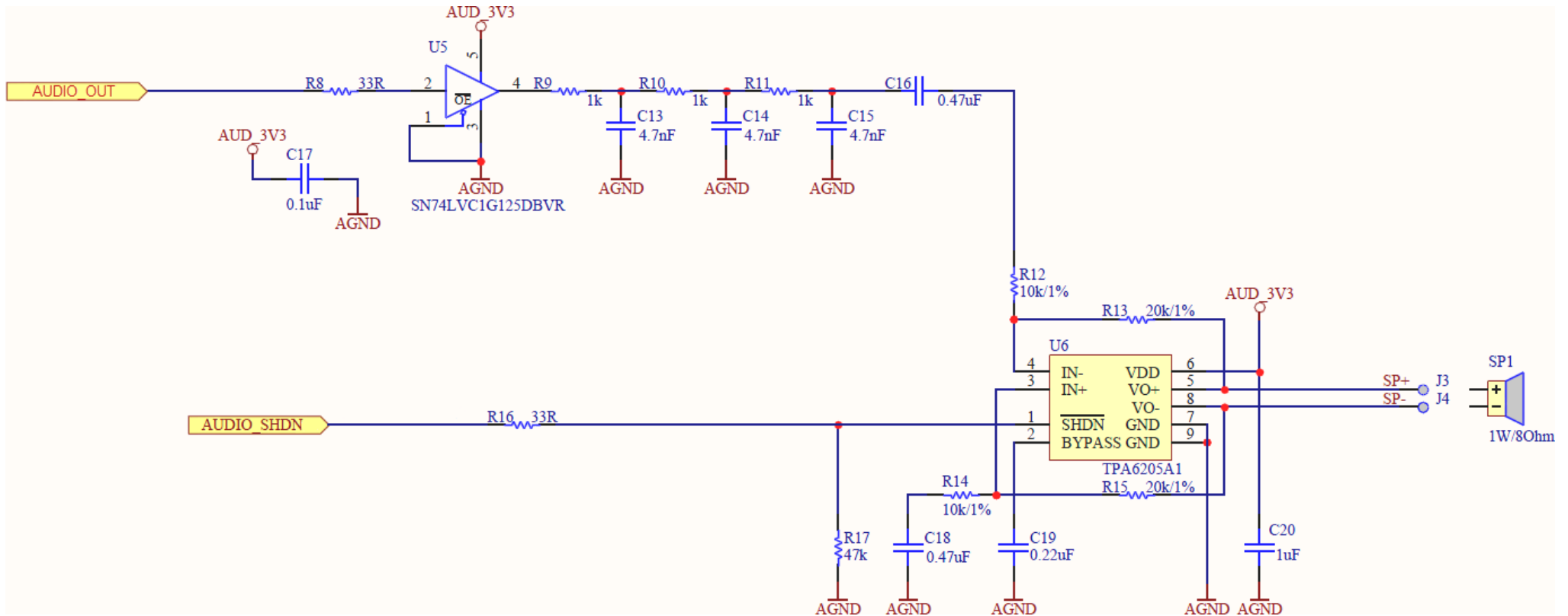

6. Display Module Numbers

The following is a breakdown of the part numbers and what they mean.

Example:

- gen4-FT812-43T

- gen4-FT813-70CT-CLB

gen4 - gen4 Display Family

FT812 - Touch Display Controller IC

FT813 - Touch Display Controller IC

43 - Display size (4.3")

70 - Display size (7.0")

T - Resistive Touch

CT - Capacitive Touch

CLB - Cover Lens Bezel

Note

- Cover Lens Bezels (CLB) are glass fronts for the display module with overhanging edges, which allow the display module to be mounted directly into a panel using special adhesive on the overhanging glass. These are available for Capacitive Touch only.
- Resistive Touch models are not available in CLB, as a CLB is made of glass and resistive touch relies on mechanical flexing of a membrane to trigger touch.

7. Cover Lens Bezel - Tape Spec

The perimeter of the CLB display modules features double-sided adhesive tape, designed to stick directly onto a panel, enclosure, box etc without the need for any mounting screws or hardware.

The tape used is 3M 9495LE tape, which uses the well-known and strong 3M 300LSE adhesive. The double-sided adhesive has a thickness of 0.17mm once the backing has been removed.

More information on this adhesive can be found on the 3M website.

8. FFC Cable

The FFC cables supplied by 4D Systems (included with products) have the following specifications:

- **30 Pin** Flexible Flat Cable, 150mm Long, 0.5mm (0.02") pitch
- Cable Type: AWM 20624 80C 60V VW-1
- Heat Resistance 80 Degrees Celsius
- Connections on the opposite side at each end (Type B)

Note

Some different length cables are available by contacting 4D Systems sales directly

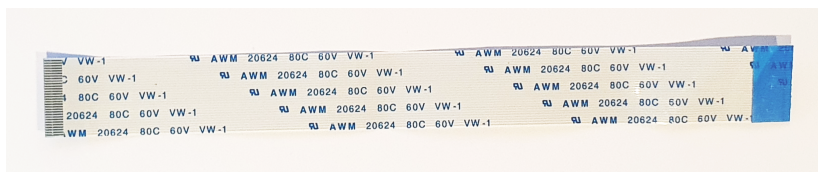

If you are interfacing to this module directly to your own product, and wish to interface via the FFC cable directly, suitable connectors are readily available from many electronics suppliers, such as Digikey, Mouser, Farnell, RS, etc.

A standard 30-pin, 0.5mm pitch, 0.3mm thick FFC, FFC connector. They are available in Top Contact and Bottom Contact, so depending how you orientate the cable on your product, will determine which one you need. Please however take care of the pinout and how it flows from the display module, through the FFC and into your product, to ensure Pin1 and Pin30 are where you expect them to be.

9. Mechanical Details 4.3" (Resistive Touch without Cover Lens Bezel)

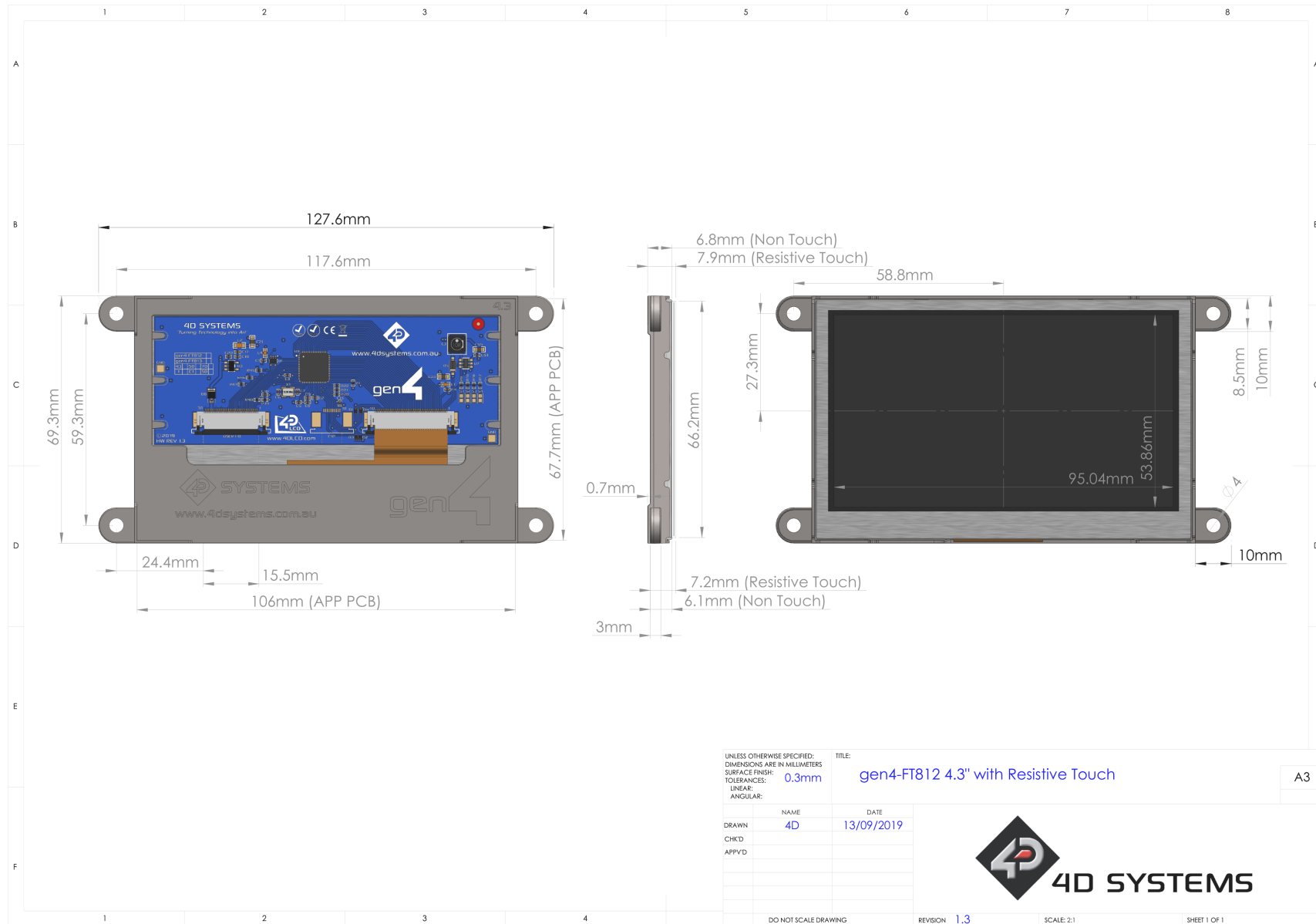

11. Mechanical Details 7.0" (Resistive Touch without Cover Lens Bezel)

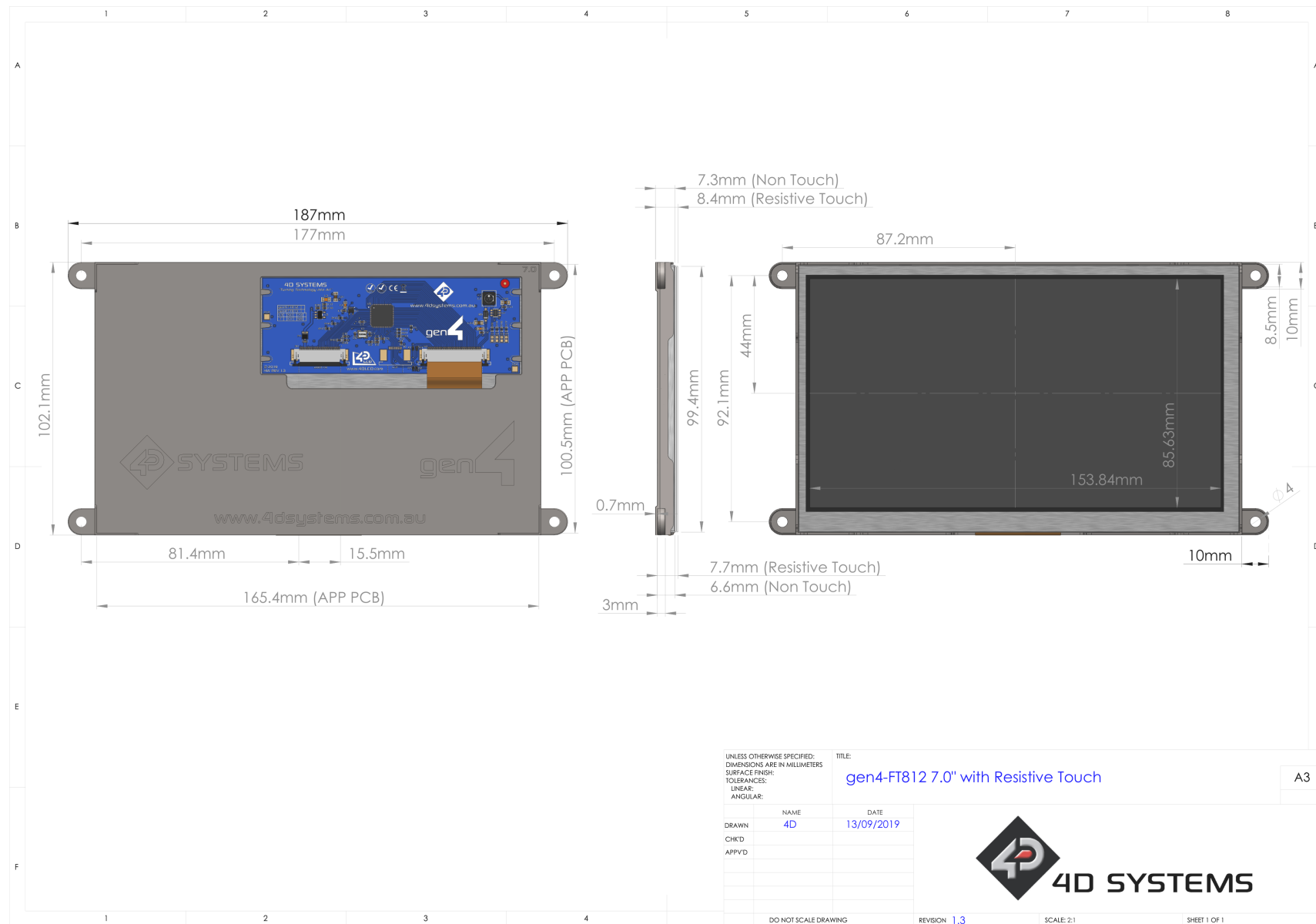

12. Mechanical Details 4.3" (Capacitive Touch without Cover Lens Bezel)

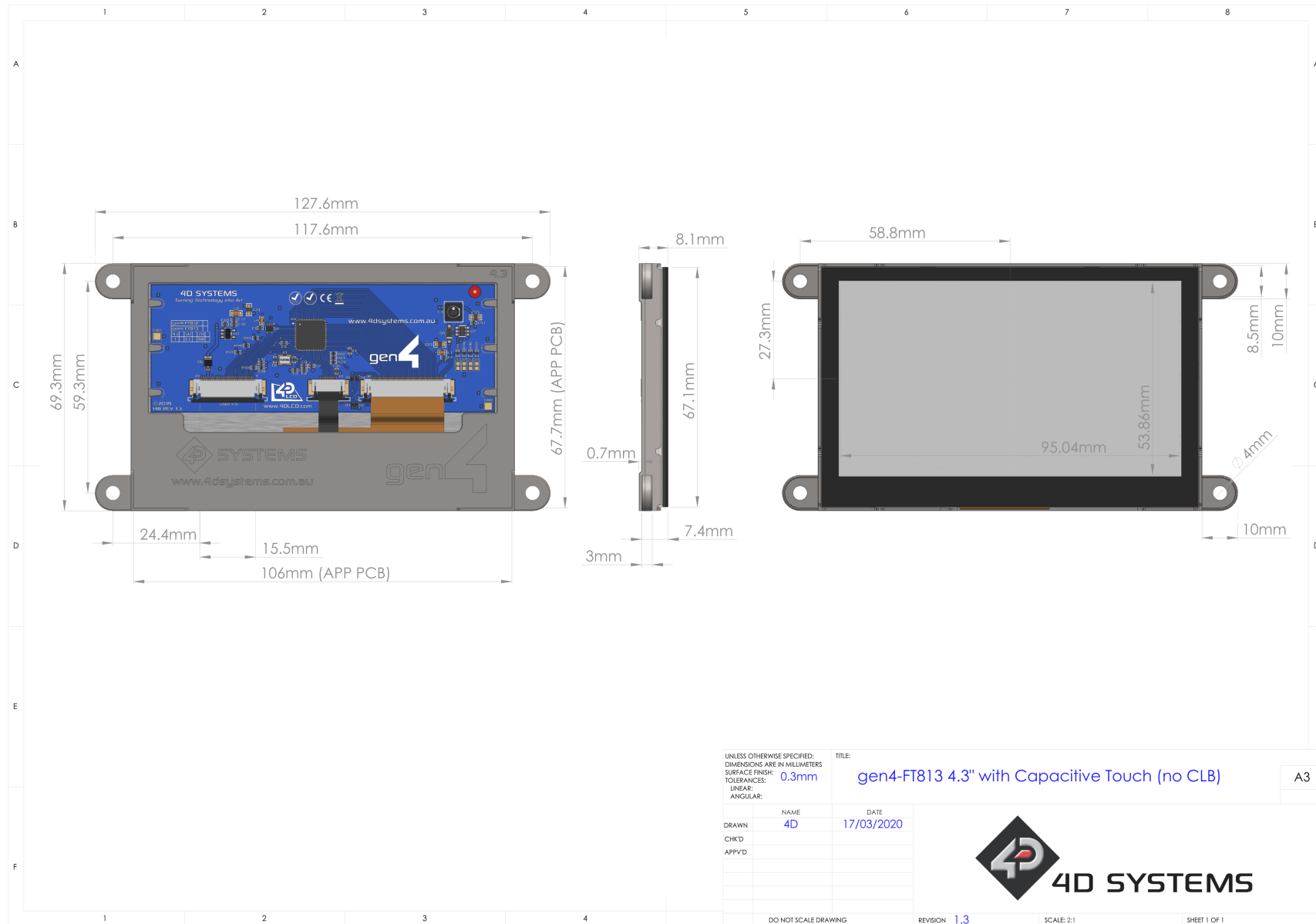

14. Mechanical Details 5.0" (Capacitive Touch with Cover Lens Bezel)

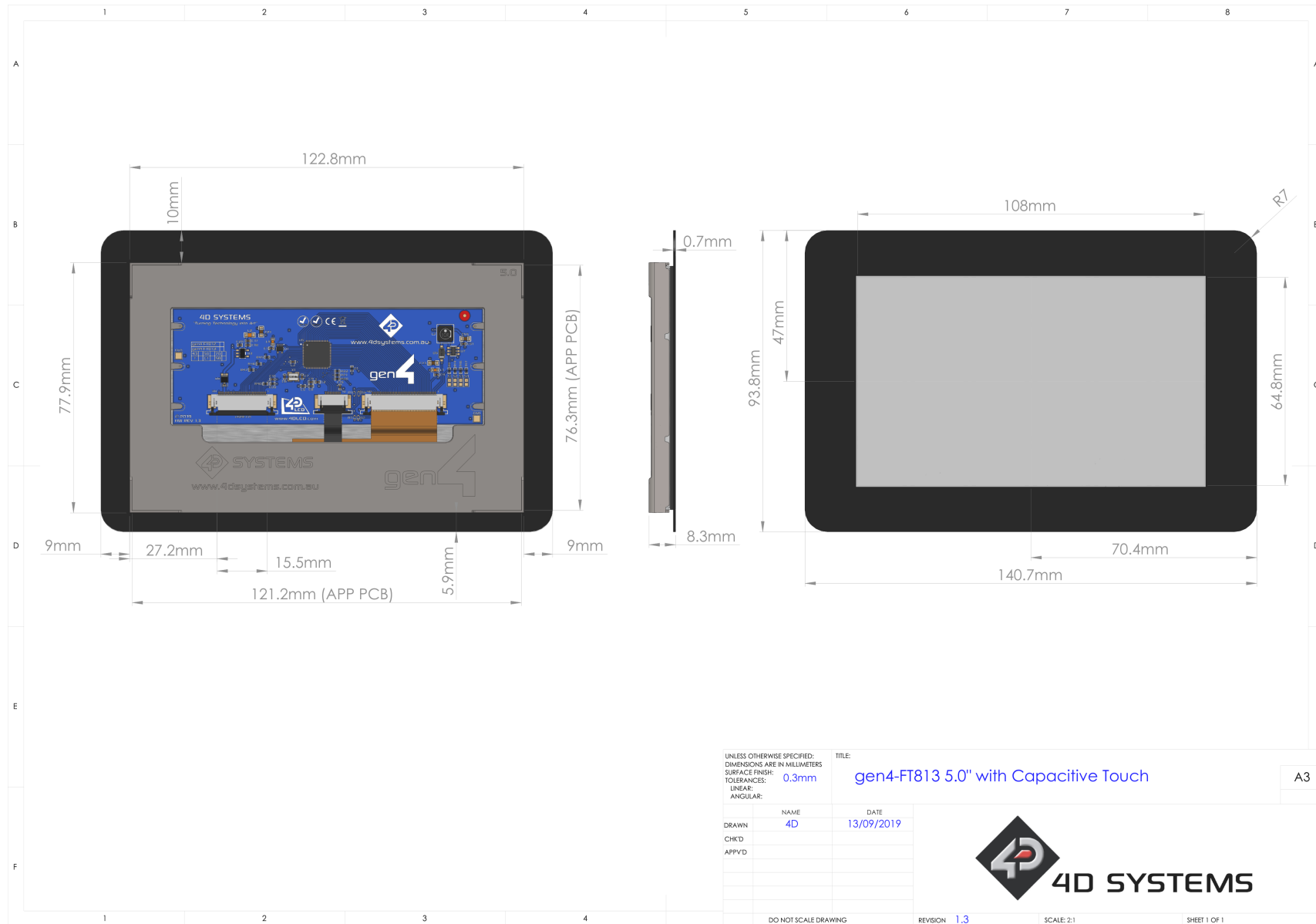

16. Schematic Details (HW REV 1.3)

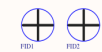
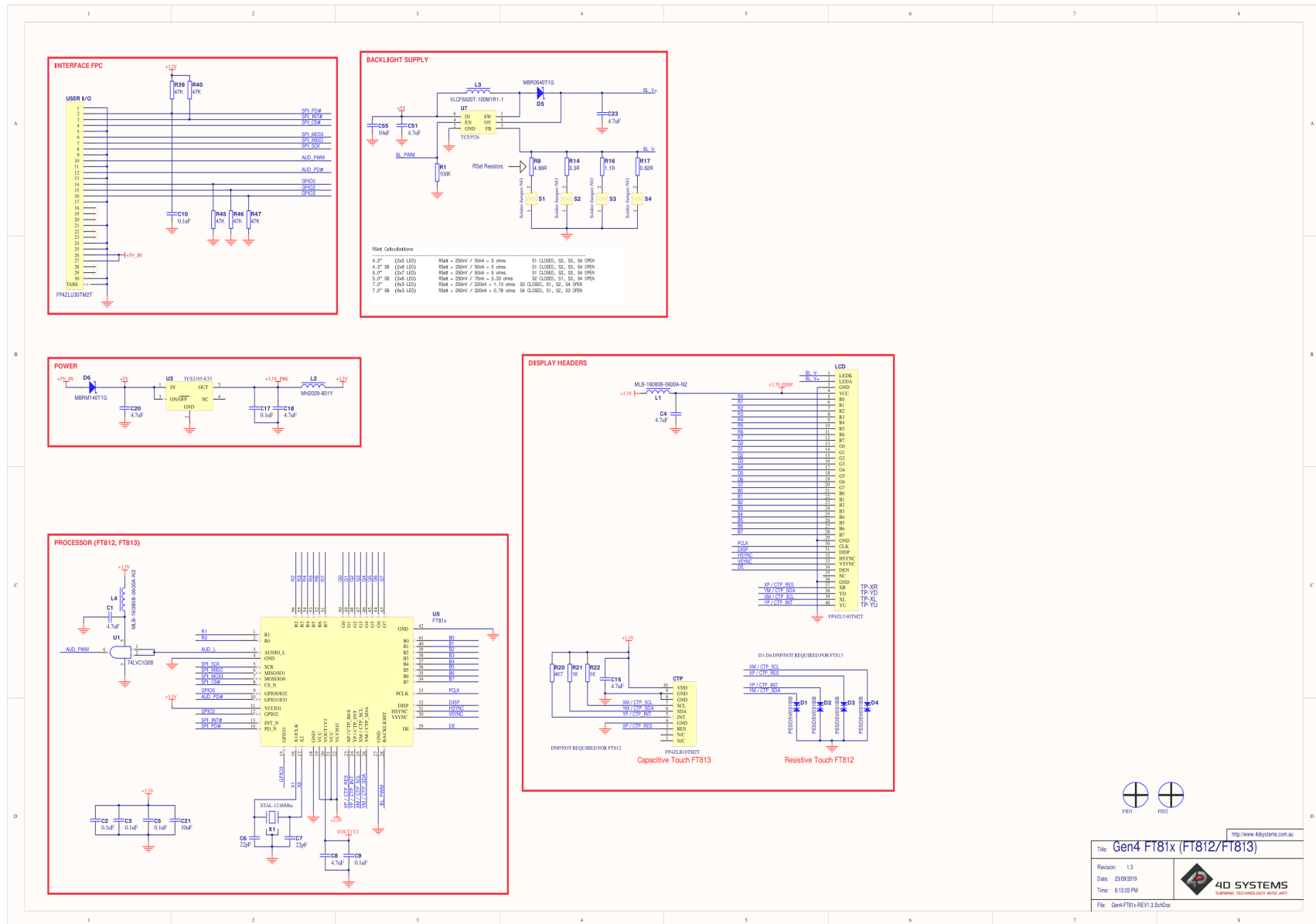

Gen4 FT81x (FT812/FT813)

Revision: 1.3
 Date: 23/09/2019
 Time: 6:13:03 PM

4D SYSTEMS
 TURNING TECHNOLOGY INTO ART

File: Gen4FT81x REV1.3.SchDoc

17. Specifications

Absolute Maximum Ratings

Operating ambient temperature	-20°C to +70°C
Storage temperature	-30°C to +80°C

Note

Stresses above those listed here may cause permanent damage to the device. This is a stress rating only and functional operation of the device at those or any other conditions above those indicated in the recommended operation listings of this specification is not implied. Exposure to maximum rating conditions for extended periods may affect device reliability.

Recommended Operating Conditions

Parameter	Conditions	Min	Typ	Max	Units
Supply Voltage (VCC)	Stable external supply required	4.5	5.0	6.0	V
Input Low Voltage	Refer FT81x Datasheet	--	--	0.8	V
Input High Voltage	Refer FT81x Datasheet	2.0	--	--	V
Output Low Voltage	I _{ol} = 5mA	--	--	0.4	V
Output High Voltage	I _{oh} = 5mA	2.9	--	--	V

 **Global Characteristics Based on Operating Conditions**

Parameter	Conditions	Min	Typ	Max	Units
Supply Current (ICC) (5V Supply used based on the gen4-FT81x-xxx module)	gen4-FT812-43T	--	360	--	mA
	gen4-FT813-43CT	--	365	--	mA
	gen4-FT813-43CT-CLB	--	365	--	mA
	gen4-FT812-50T	--	520	--	mA
	gen4-FT813-50CT-CLB	--	525	--	mA
	gen4-FT812-70T	--	830	--	mA
	gen4-FT813-70CT-CLB	--	835	--	mA
Display Endurance	Hours of operation, measured to when the display is 50% original brightness	30	--	--	H
Touch Screen Endurance (Resistive Touch)	Number of touches/hits with a 12.55mm tip at a rate of 2x per second with 250gf force	--	1M	--	Touches
	Slide stylus on screen, 100gf force, 60mm/s speed with a 0.8mm polyacetal tip stylus pen	--	100K	--	Slides
Touch Screen Transparency	Resistive Touch	82	--	--	%
	Capacitive Touch	90	--	--	%
Touch Screen Operational Force (Resistive Touch)	Only use Finger or Stylus, do not use anything sharp or metal	20	--	100	Gf

 **LCD Display Information (IPS)**

Parameter	Conditions	Specification
Display Type	gen4-FT812-43T – Modules produced March 2021 onwards. gen4-FT813-43CT – Modules produced May 2020 onwards. gen4-FT813-43CT-CLB – Modules produced March 2021 onwards. gen4-FT812-50T – Modules produced March 2021 onwards. gen4-FT813-50CT-CLB – Modules produced September 2020 onwards.	TN - TFT Transmissive LCD
Display Size		4.3", 5.0" Diagonal
Display Resolution	4.3"	480 x 272 (Landscape Viewing)
	5.0"	800 x 480 (Landscape Viewing)
Display Brightness (Max. Brightness)	gen4-FT812-43T	510 cd/m ²
	gen4-FT812-43CT	540 cd/m ²
	gen4-FT812-43CT-CLB	540 cd/m ²
	gen4-FT812-50T	510 cd/m ²
	gen4-FT812-50CT-CLB	540 cd/m ²
Display Contrast Ratio	gen4-FT81x-43xx - Typical	800:1
	gen4-FT81x-50xx - Typical	1000:1
Display Viewing Angles	Above Centre	80 Degrees
	Below Centre	80 Degrees
	Left of Centre	80 Degrees
	Right of Centre	80 Degrees
Display Viewing Direction		ALL (wide viewing IPS Display)
Display Backlighting	gen4-FT81x-43xx Model	2x5 Parallel LED's
	gen4-FT81x-50xx Model	3x6 Parallel LED's
Pixel Pitch	4.3"	0.198 x 0.198 mm (Square pixels)
	5.0"	0.135 x 0.135 mm (Square pixels)
Pixel Density	4.3"	128 DPI/PPI
	5.0"	183 DPI/PPI

 **LCD Display Information (TN)**

Parameter	Conditions	Specification
Display Type	All displays produced before the IPS release date in the IPS table below, or any modules not specified are therefore TN type displays.	TN - TFT Transmissive LCD
Display Size		4.3", 5.0", 7.0" Diagonal
Display Resolution	4.3"	480 x 272 (Landscape Viewing)
	5" & 7"	800 x 480 (Landscape Viewing)
Display Brightness (Max. Brightness)	gen4-FT812-43T	400 cd/m2
	gen4-FT812-43CT	475 cd/m2
	gen4-FT812-43CT-CLB	475 cd/m2
	gen4-FT812-50T	400 cd/m2
	gen4-FT812-50CT-CLB	475 cd/m2
	gen4-FT812-70T	400 cd/m2
	gen4-FT812-70CT-CLB	475 cd/m2
Display Contrast Ratio	Typical	500:1
Display Viewing Angles	Above Centre	70 Degrees
	Below Centre	60 Degrees / 50 Degrees for 5.0"
	Left of Centre	70 Degrees
	Right of Centre	70 Degrees
Display Viewing Direction		12 O'clock Display (Optimal viewing is from above when in Landscape/Wide mode)
Display Backlighting	gen4-FT81x-43xx Model	2x5 Parallel LED's
	gen4-FT81x-50xx Model	2x6 Parallel LED's
	gen4-FT81x-70xx Model	9x3 Parallel LED's
Pixel Pitch	4.3"	0.198 x 0.198 mm (Square pixels)
	5.0"	0.135 x 0.135 mm (Square pixels)
	7.0"	0.1925 x 0.179 mm (Square pixels)

Parameter	Conditions	Specification
	4.3"	128 DPI/PPI
	5.0"	183 DPI/PPI
	7.0"	132 DPI/PPI (Horizontal) 142 DPI/PPI (Vertical)

18. LCD Timing Details

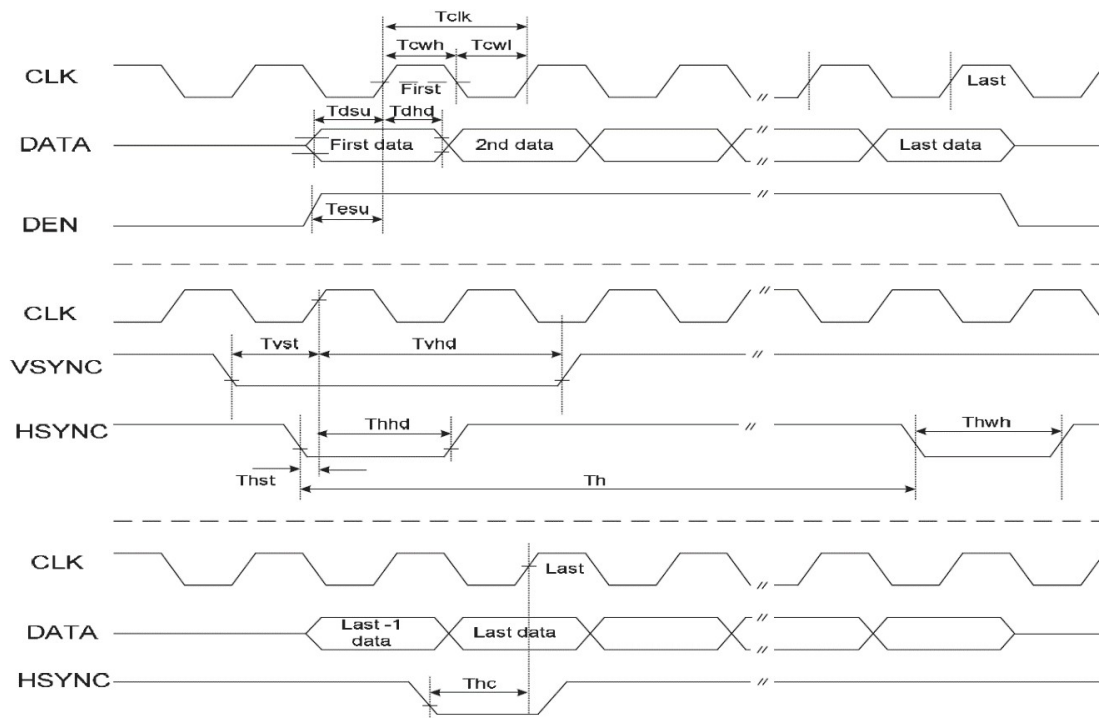

LCD Timing Chart

Parameter	Symbol	Min	Typ	Max	Units	Conditions
CLK Clock Time	Tclk	1/Max(FCLK)	-	1/Min(FCLK)	ns	-
CLK Pulse Duty	Tcwh	40	50	60	%	TCLK
HSYNC to CLK	Thc	-	-	1	CLK	-
HSYNC Width	Thwh	1	-	-	CLK	-
VSYNC Width	Tvwh	1	-	-	ns	-
HSYNC Period Time	Th	-	-	-	ns	-
VSYNC Set-up Time	Tvst	12	-	-	ns	-
VSYNC Hold Time	Tvhd	12	-	-	ns	-
HSYNC Setup Time	Thst	12	-	-	ns	-
HSYNC Hold Time	Thhd	12	-	-	ns	-
Data Set-up Time	Tdsu	12	-	-	ns	D00~D23 to CLK
Data Hold Time	Tdhd	12	-	-	ns	D00~D23 to CLK

Parameter	Symbol	Min	Typ	Max	Units	Conditions
DEN Set-up Time	Tesu	12	-	-	ns	DEN to CLK

 **Note**

Timing parameter (VDD=3.3V, GND=0V, Ta=25 °C)

19. LCD Timing Characteristic

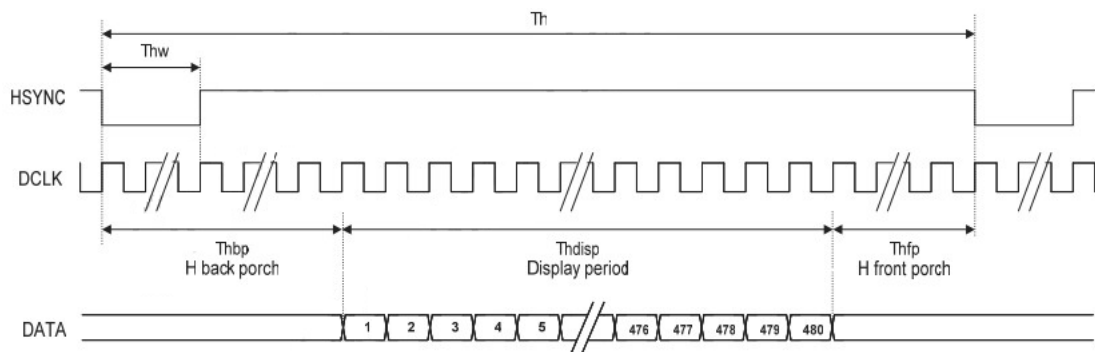

Sync Mode Timing Diagram

4.3" LCD Timing Characteristic (TN & IPS)

ITEM	SYMBOL	MIN	TYP	MAX	UNIT	
DCLK Frequency	Fclk	8	9	12	MHz	
DCLK Period	Tclk	83	111	125	ns	
Hsync Period Time	T_h	485	531	598	DCLK	
Hsync Display Period	T_{hdisp}	-	480	-	DCLK	
Hsync Back Porch	T_{hbp}	3	43	43	DCLK	By H Blanking Setting
Hsync Front Porch	T_{hfp}	2	8	75	DCLK	
Hsync Pulse Width	T_{hw}	2	4	43	DCLK	
Vsync Period Time	T_v	276	292	321	H	
Vsync Display Period	T_{vdisp}	-	272	-	H	
Vsync Back Porch	T_{vbp}	2	12	12	H	By V Blanking Setting
Vsync Front Porch	T_{vfp}	2	8	37	H	
Vsync Pulse Width	T_{vw}	2	4	12	H	

5.0" LCD Timing Characteristic (TN)						
ITEM	SYMBOL	MIN	TYP	MAX	UNIT	
DCLK Frequency	Fclk	-	33.3	50	MHz	
DCLK Period	Tclk	-	-	-	ns	
Hsync Period Time	Th	862	1056	1200	DCLK	
Hsync Display Period	Thdisp	-	800	-	DCLK	
Hsync Back Porch	Thbp	46	46	46	DCLK	By H Blanking Setting
Hsync Front Porch	Thfp	16	210	354	DCLK	
Hsync Pulse Width	Thw	1	2	40	DCLK	
Vsync Period Time	Tv	510	525	650	H	
Vsync Display Period	Tvdisp	-	480	-	H	
Vsync Back Porch	Tvbp	23	23	23	H	By V Blanking Setting
Vsync Front Porch	Tvfp	7	22	147	H	
Vsync Pulse Width	Tvw	1	10	20	H	

5.0" LCD Timing Characteristic (IPS)						
ITEM	SYMBOL	MIN	TYP	MAX	UNIT	
DCLK Frequency	Fclk	23	25	27	MHz	
Hsync Period Time	Th	808	816	896	DCLK	
Hsync Display Period	Thdisp	-	800	-	DCLK	
Hsync Back Porch	Thbp	4	8	48	DCLK	By H Blanking Setting
Hsync Front Porch	Thfp	4	8	48	DCLK	
Hsync Pulse Width	Thw	2	4	8	DCLK	
Vsync Period Time	Tv	488	496	504	H	
Vsync Display Period	Tvdisp	-	480	-	H	
Vsync Back Porch	Tvbp	4	8	12	H	By V Blanking Setting
Vsync Front Porch	Tvfp	4	8	12	H	
Vsync Pulse Width	Tvw	2	4	8	H	

5.0" LCD Timing Characteristic (TN)						
ITEM	SYMBOL	MIN	TYP	MAX	UNIT	
DCLK Frequency	Fclk	20	33.3	50	MHz	
DCLK Period	Tclk	-	-	-	ns	
Hsync Period Time	Th	908	928	1088	DCLK	
Hsync Display Period	Thdisp	-	800	-	DCLK	
Hsync Back Porch	Thbp	1	40	87	DCLK	By H Blanking Setting
Hsync Front Porch	Thfp	20	40	200	DCLK	
Hsync Pulse Width	Thw	1	4	43	DCLK	
Vsync Period Time	Tv	517	525	712	H	
Vsync Display Period	Tvdisp	-	480	-	H	
Vsync Back Porch	Tvbp	29	31	31	H	By V Blanking Setting
Vsync Front Porch	Tvfp	5	13	200	H	
Vsync Pulse Width	Tvw	1	1	3	H	